



IDEA BOOK

**BUILD 10 LODGES WITH EASY
STEP-BY-STEP INSTRUCTIONS**

LOG-O-LODGE Building Set is intended to provide hours of fun and entertainment for children of all ages. It's a creative way to develop your child's motor skills, spatial thinking and hand to eye coordination.

This building set is made of 100% natural Canadian wood without the use of any toxic substances or dyes. LOG-O-LODGE toys are made only from eco-friendly and sustainable materials.



HOW TO USE LOG-O-LODGE

You can build a wide variety of buildings using the LOG-O-LODGE set. Enclosed you will find detailed instructions for 10 different designs that vary in complexity. Overall, hundreds of combinations are possible, but these initial designs are a good way to make your child's first experience with LOG-O-LODGE fun and easy.

SOME SIMPLE STEPS TO KEEP IN MIND:

- Each consecutive picture shows a new layer.
- Each new layer is shown in bright colors.
- Logs highlighted yellow always go first and then green logs sit across.
- If there is a number of layers on the same picture that means layers are identical.

The goal of the models is to demonstrate the basic concepts of log construction and different design options available. With a little practice, your child will quickly find that there are no limits to what they can build. When your child needs more logs, they are always available in different sets and configurations.

NOTE TO PARENTS

This set contains precision made parts crafted to fit together. Please be patient and do not use excessive force while assembling the building. We would highly recommend parental supervision while building the first lodge.

Find the right parts in the box!

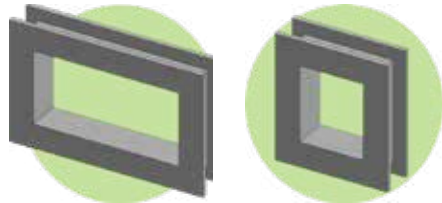

4

2

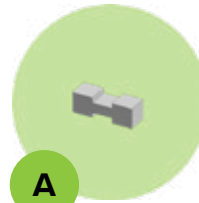

A

97

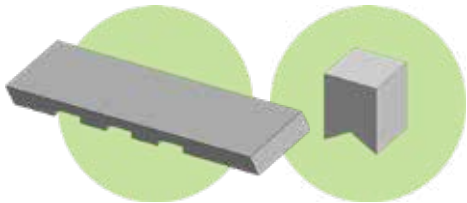

14

1

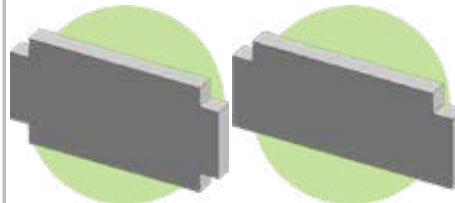

2

2

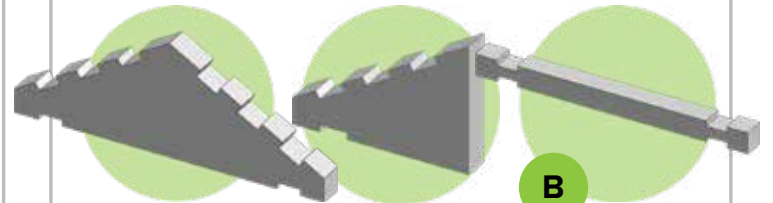

2

2

B

36

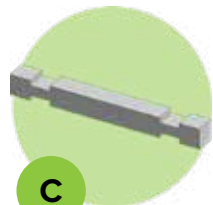

C

12

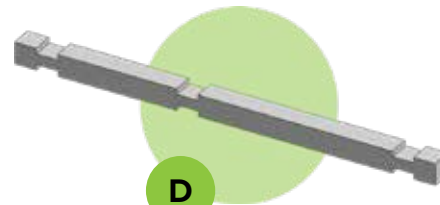

D

26

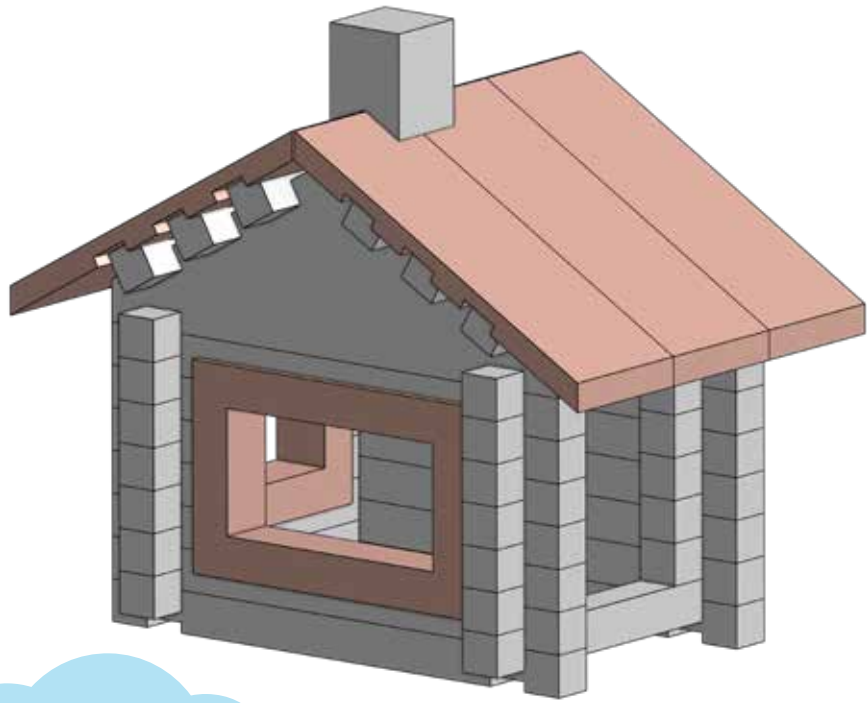

LODGE #1

1



2

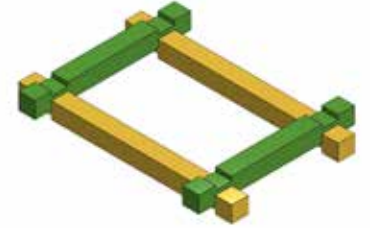

3

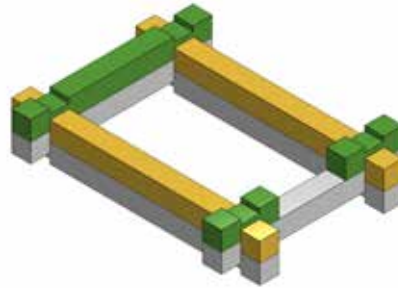

4

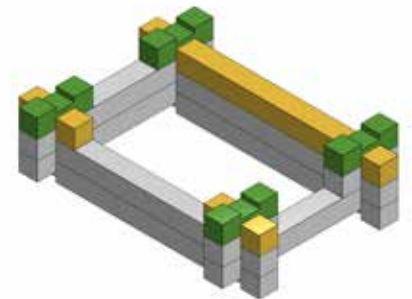

5

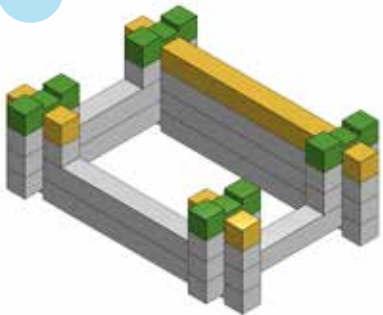

6

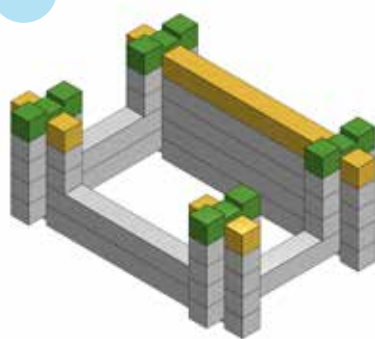

7

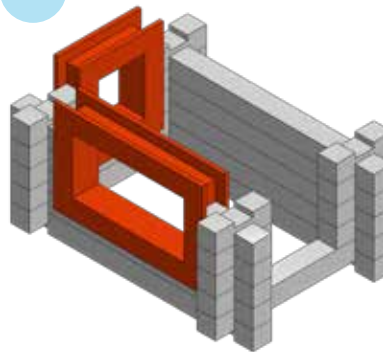

8

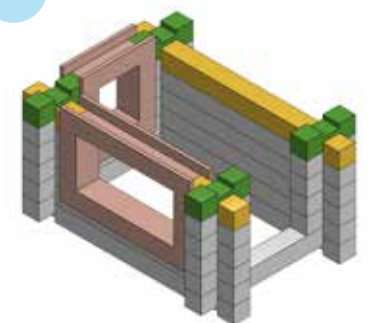

9



10

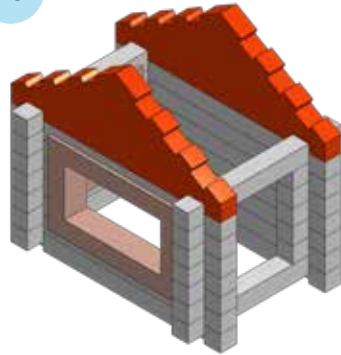

11

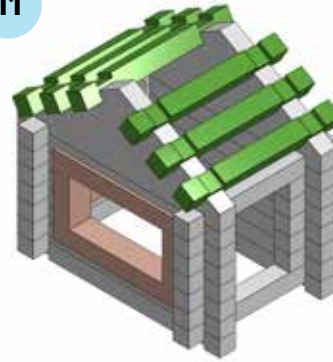

12

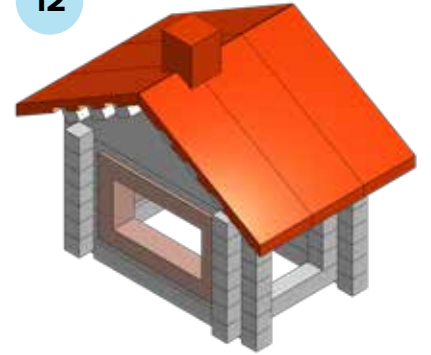

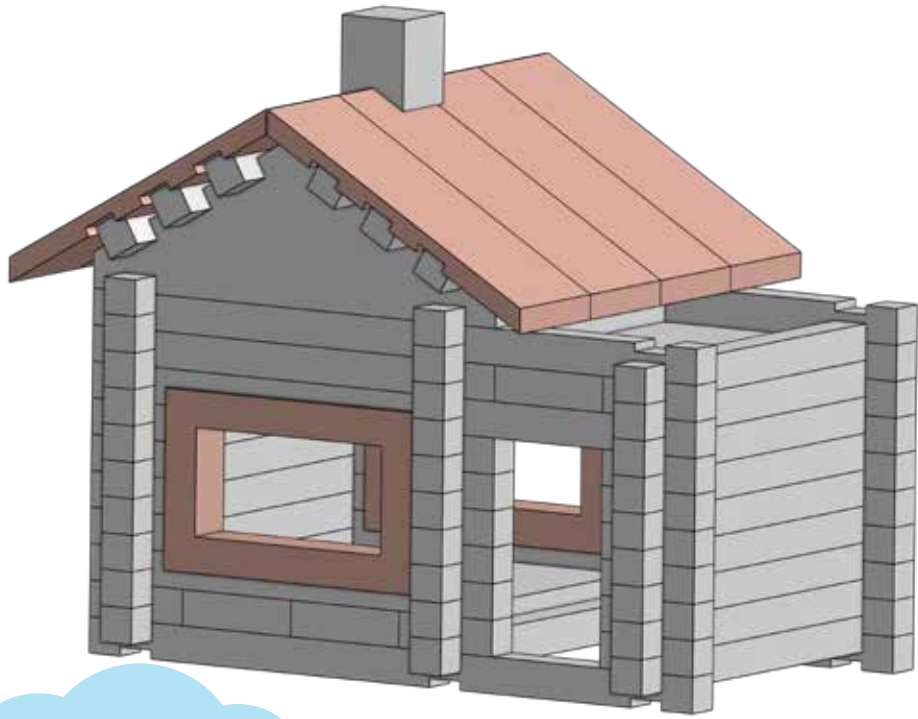

LODGE #2

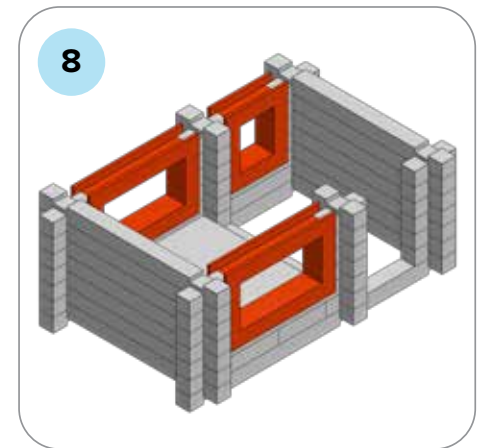
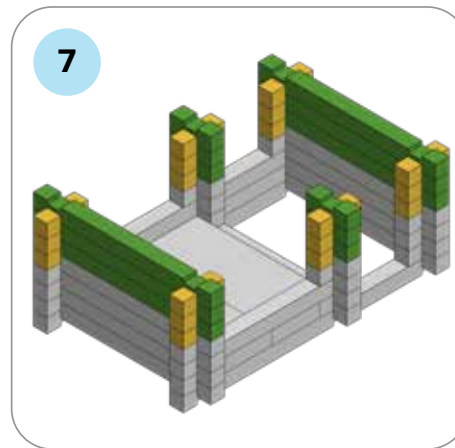
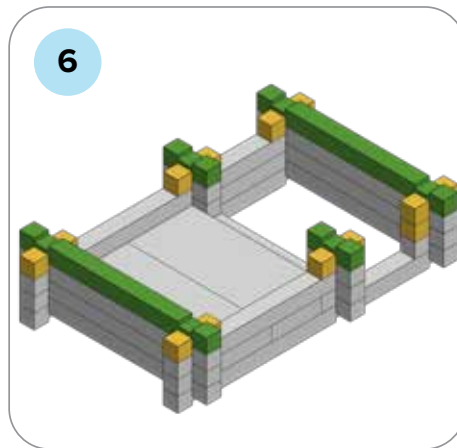
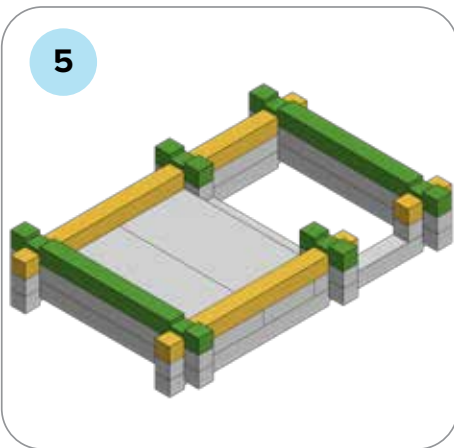
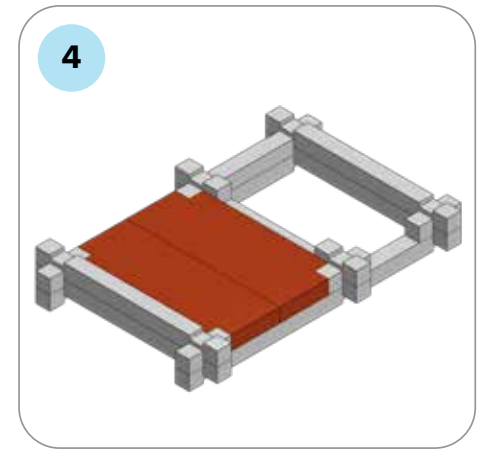
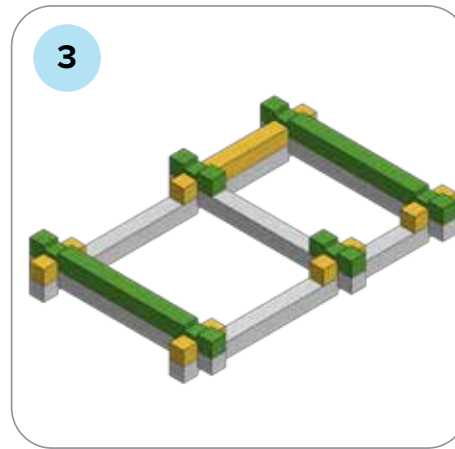
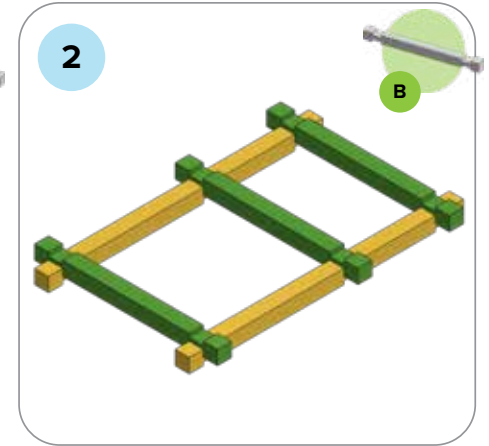
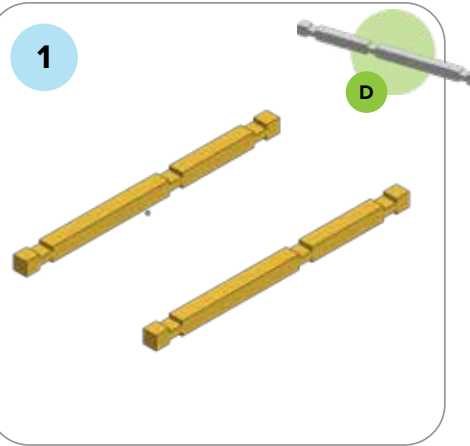

9

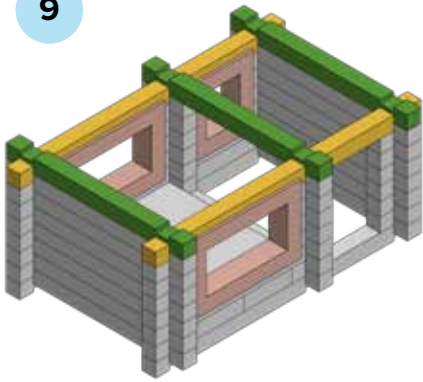

10

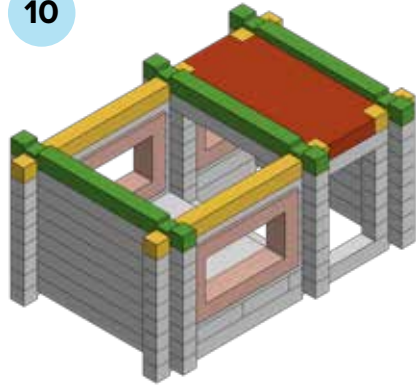

11

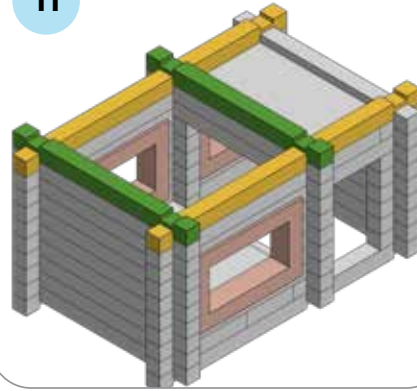

12

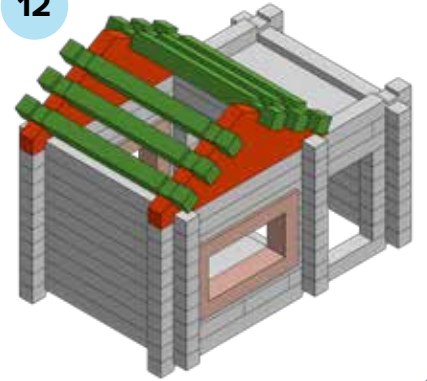

13

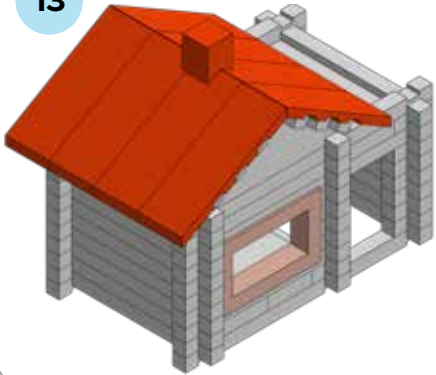

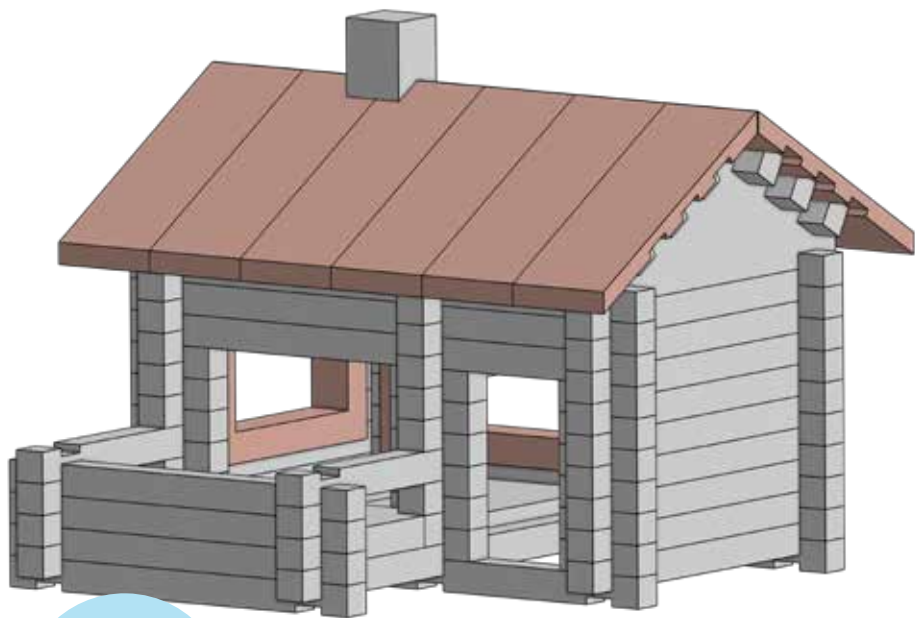

LODGE #3

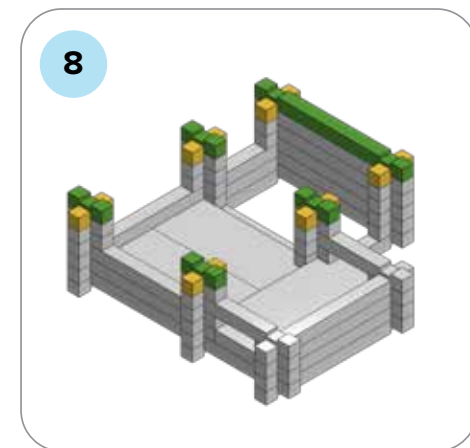
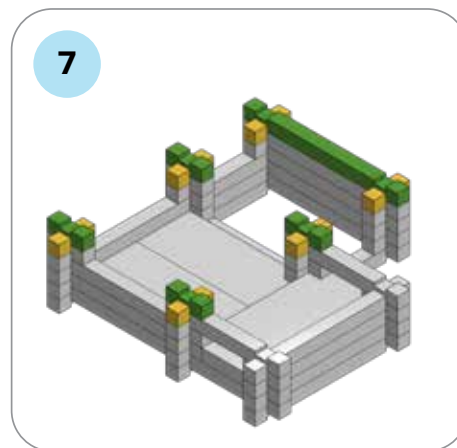
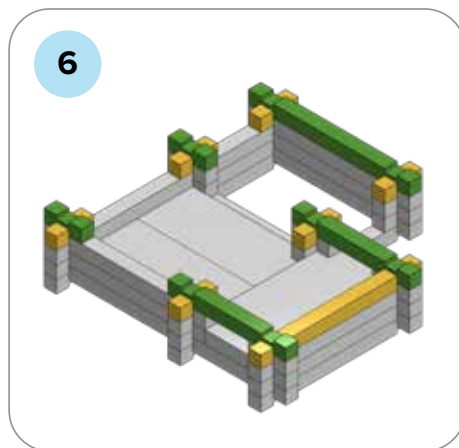
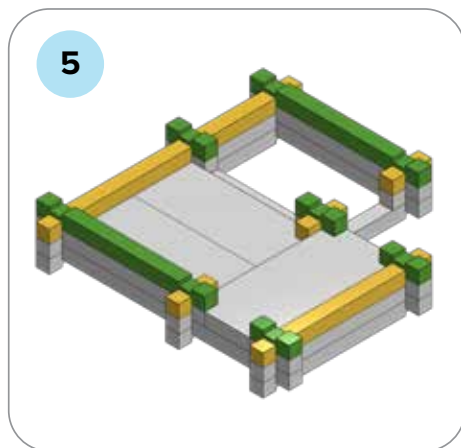
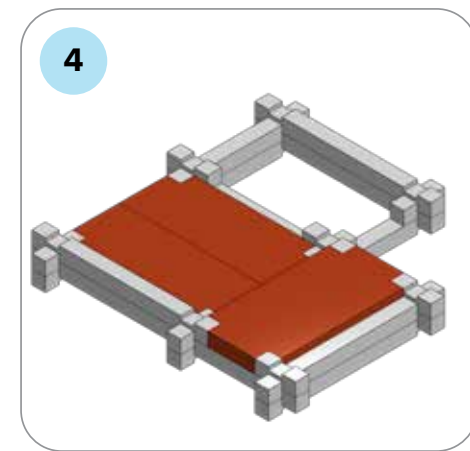
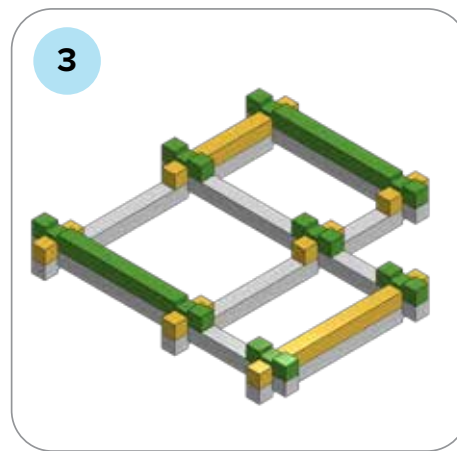
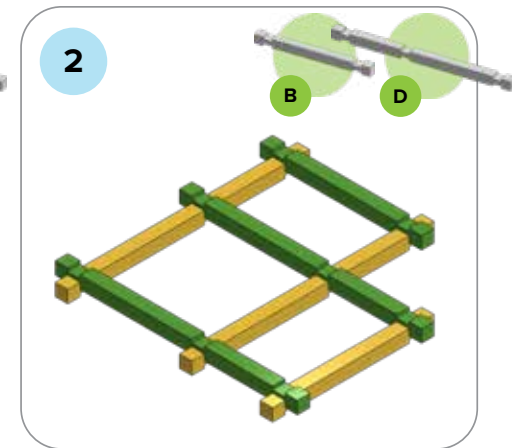
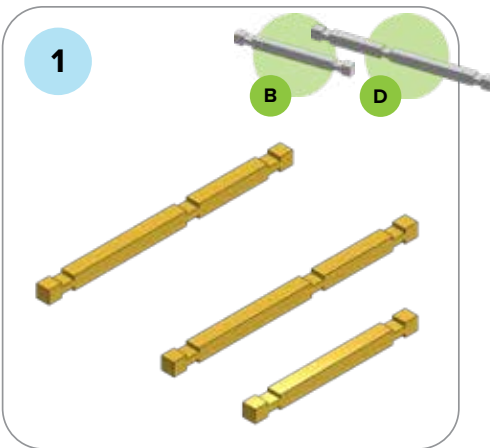

9

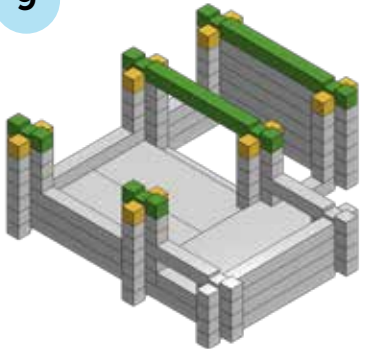

10

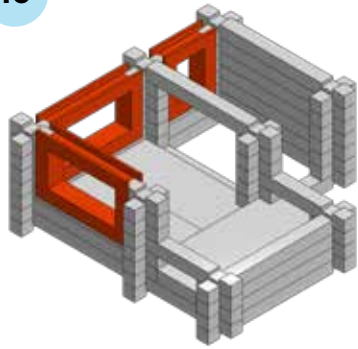

11

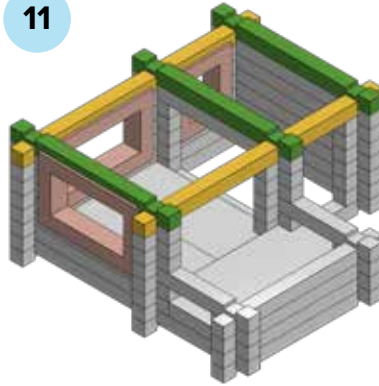

12

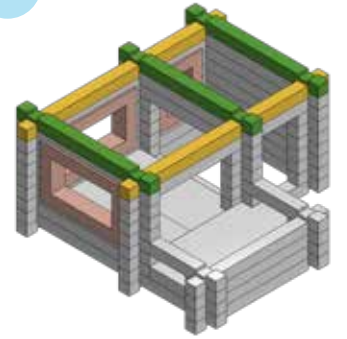

13

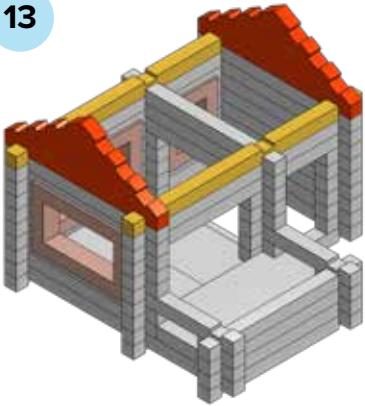

14

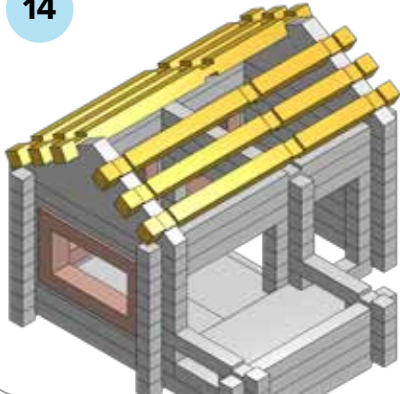

15



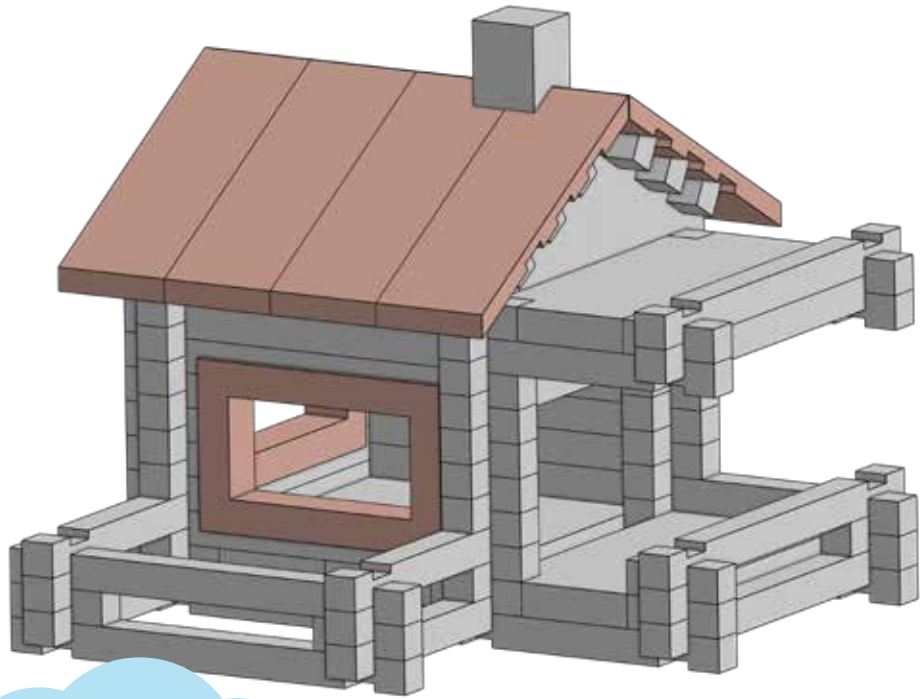

LODGE #4

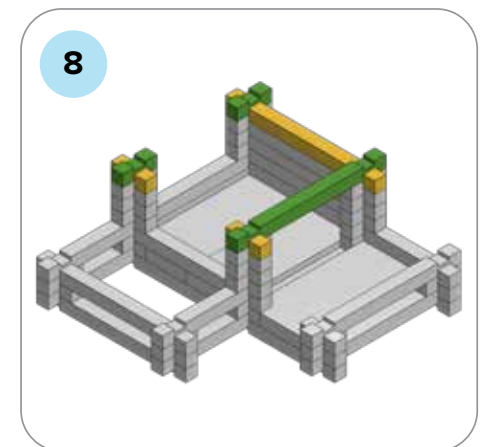
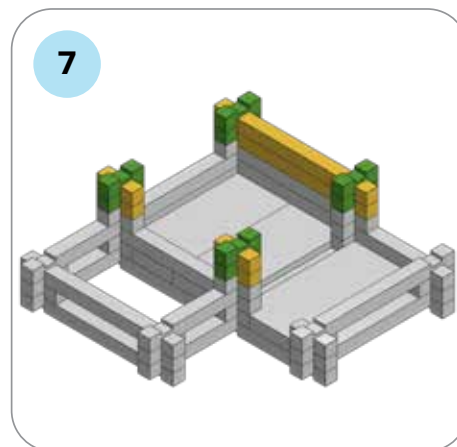
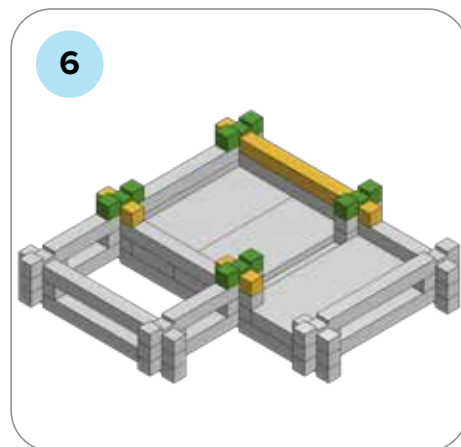
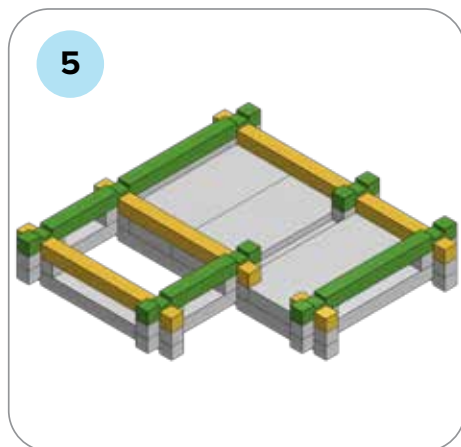
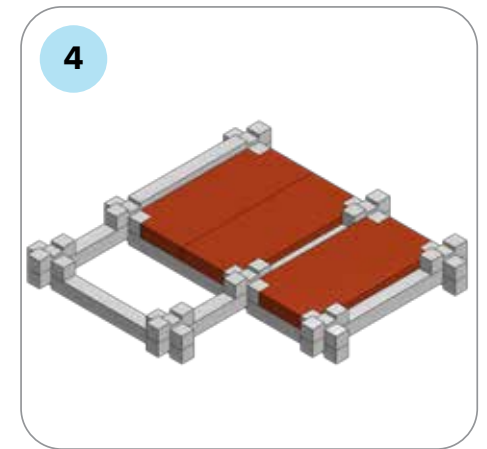
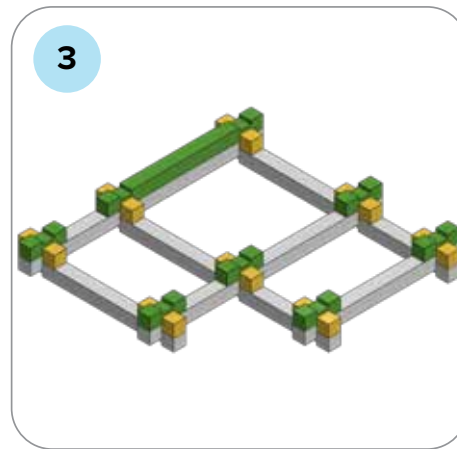
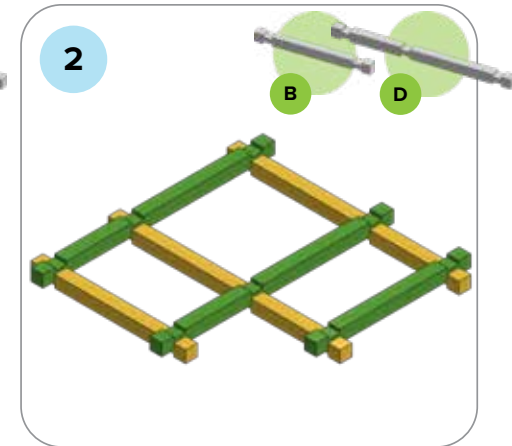
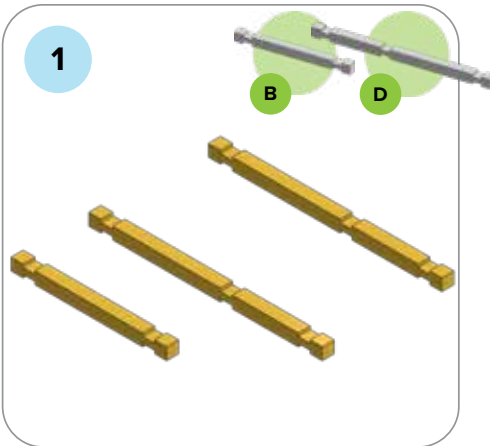

9

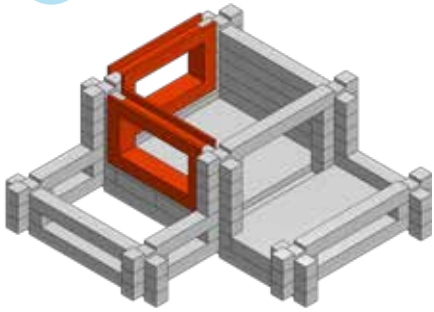

10

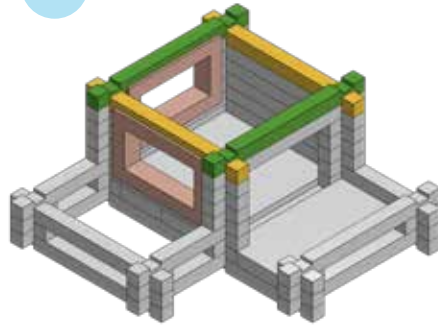

11

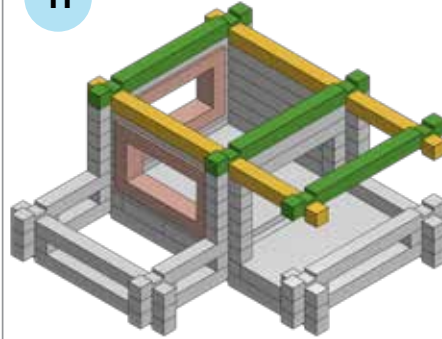

12

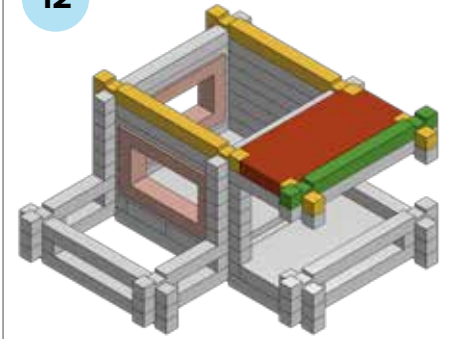

13

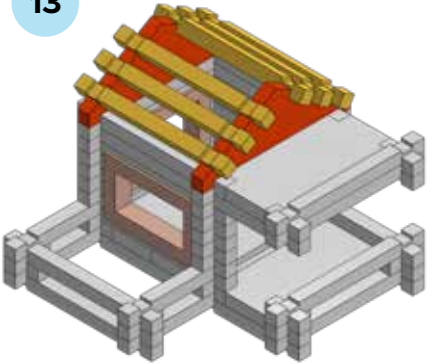

14

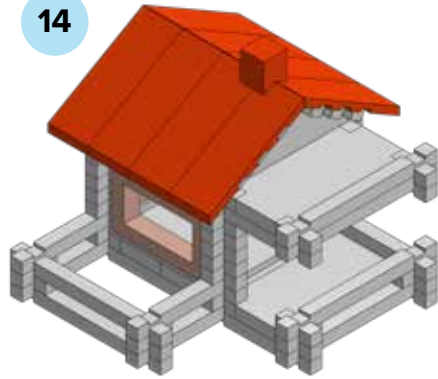

15

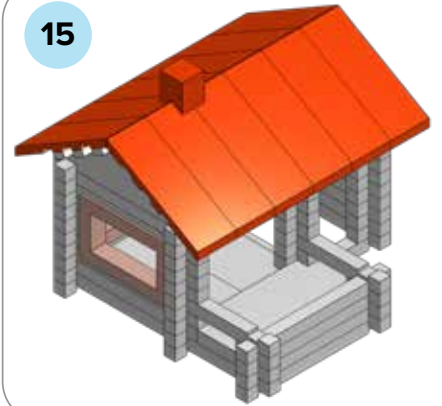

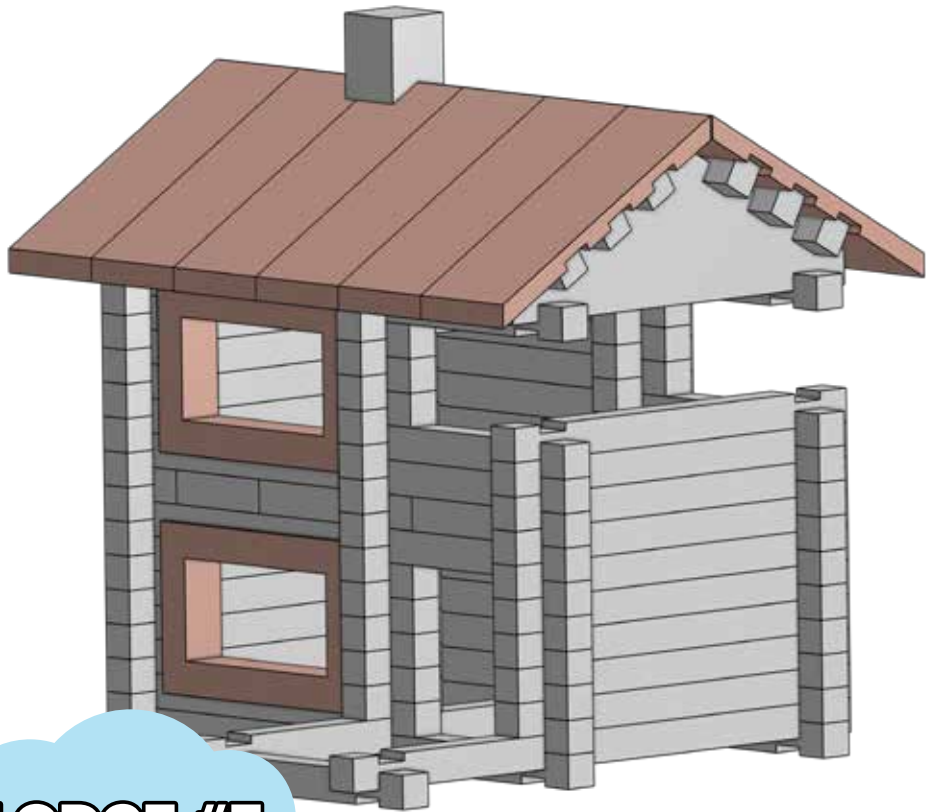

LODGE #5

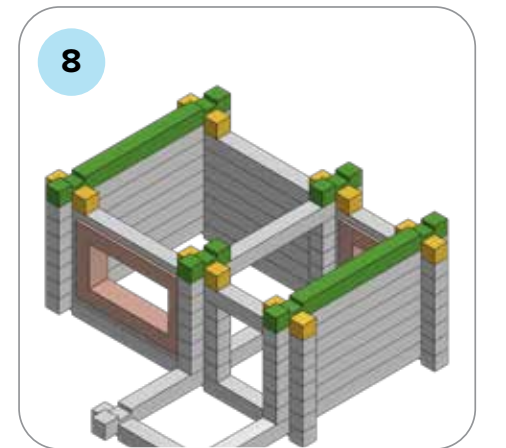
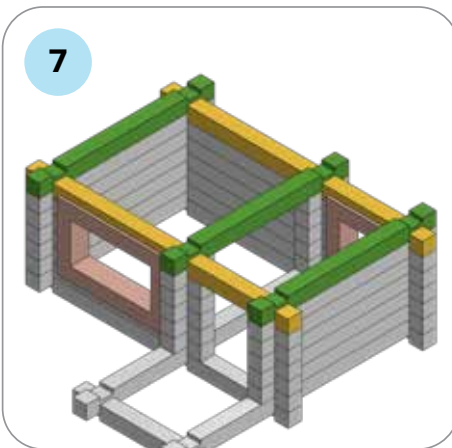
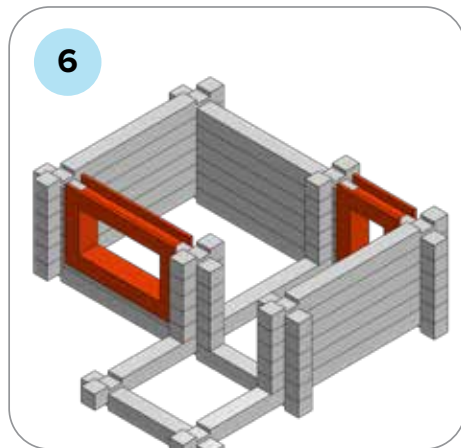
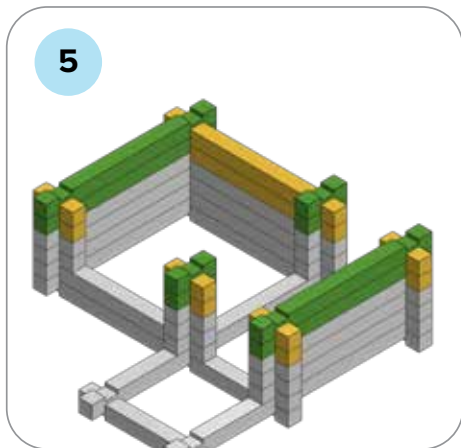
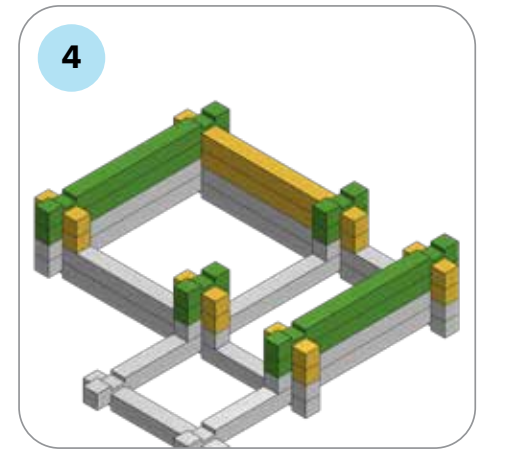
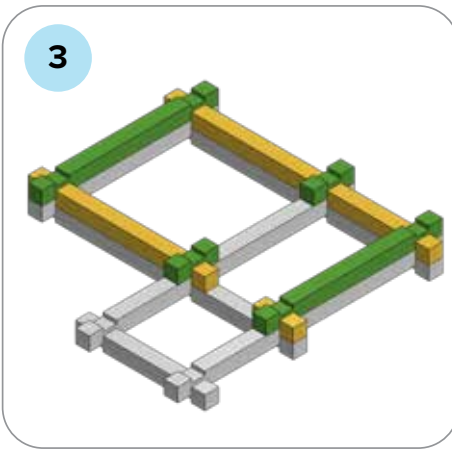
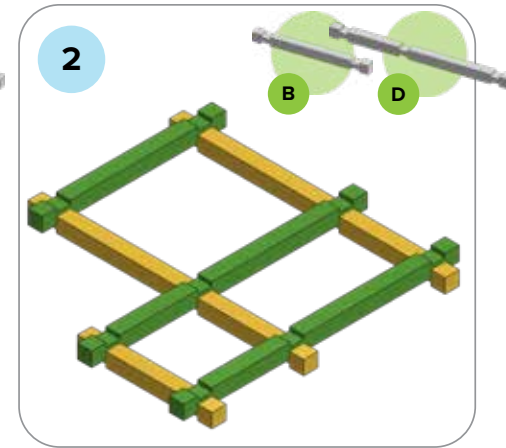
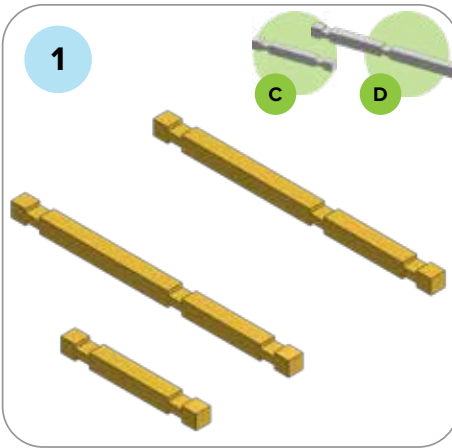

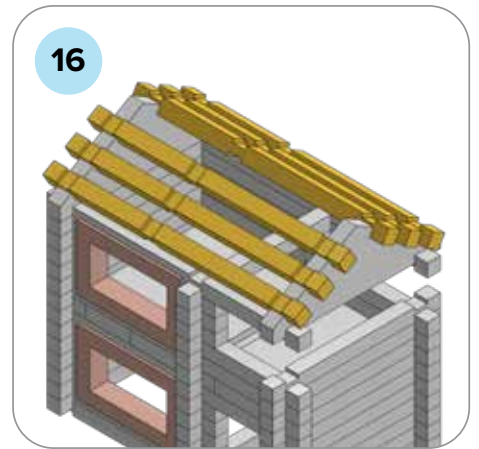
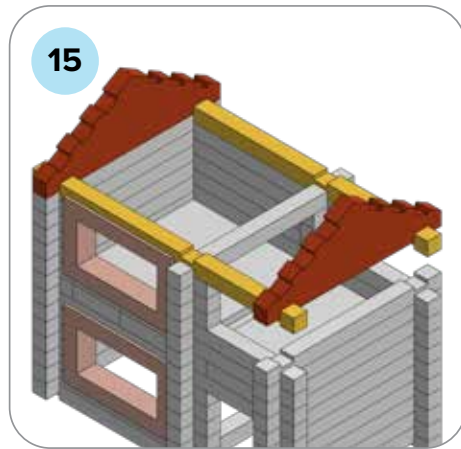
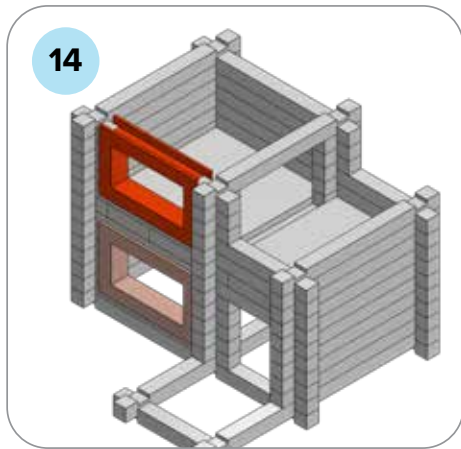
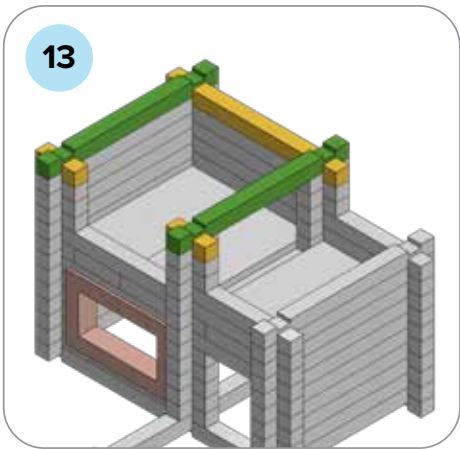
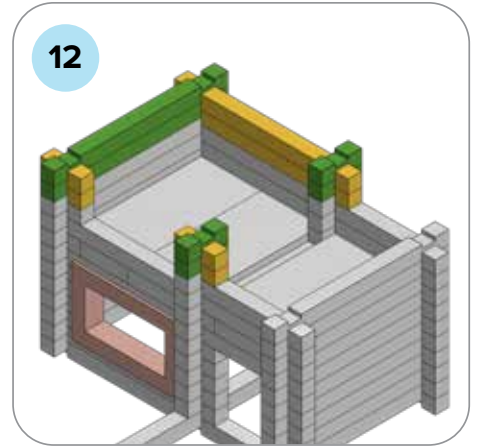
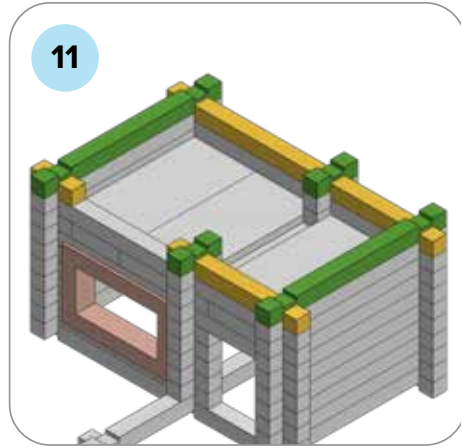
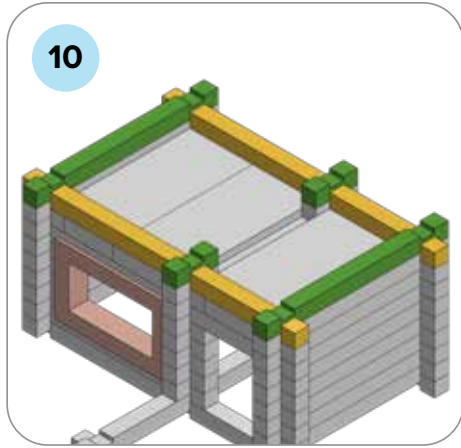
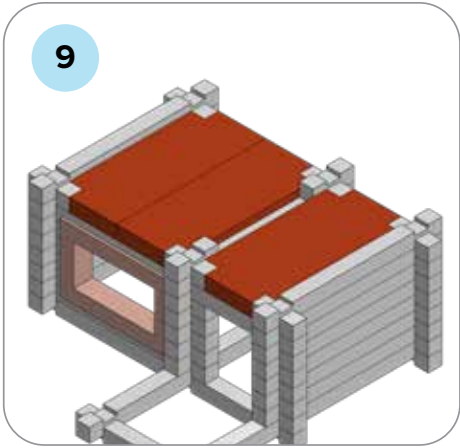

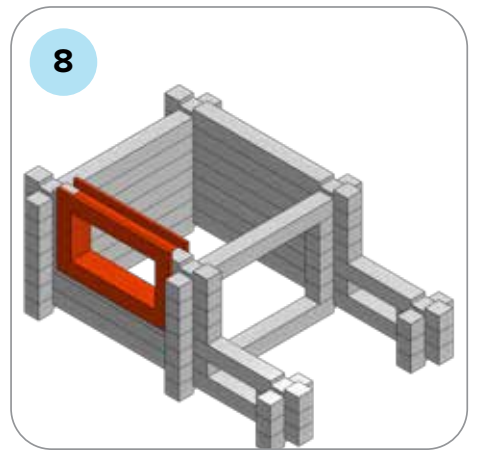
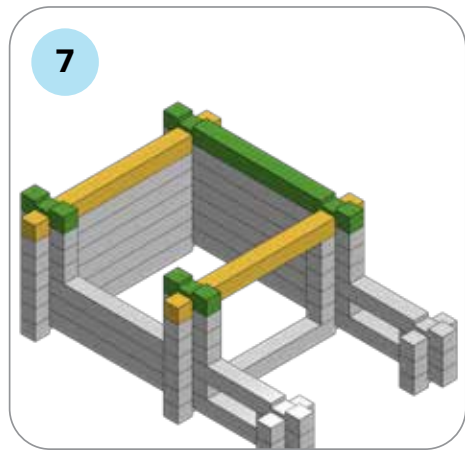
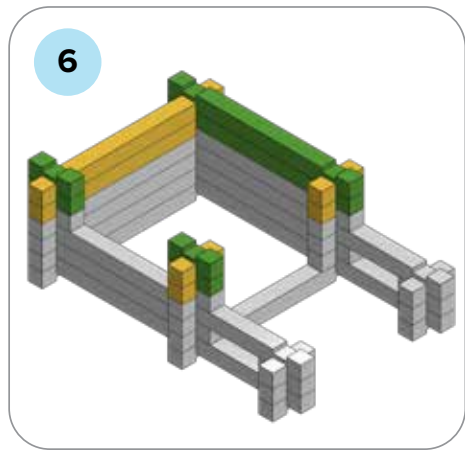
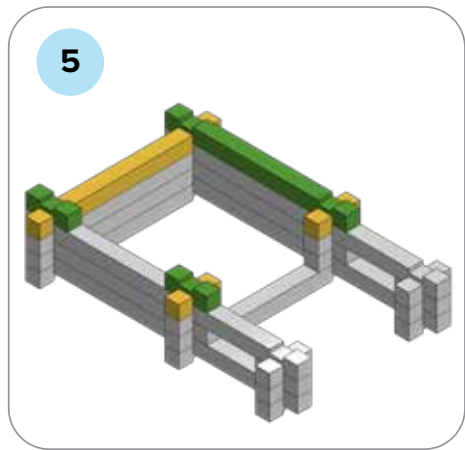
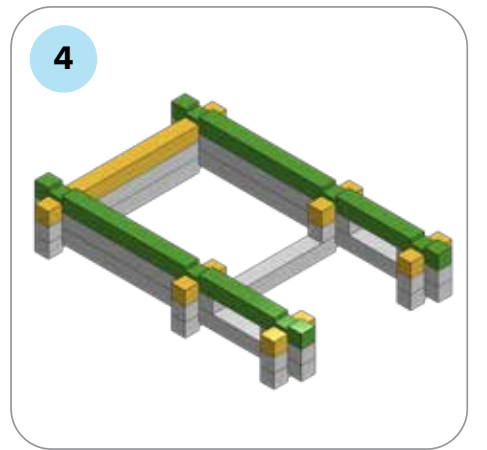
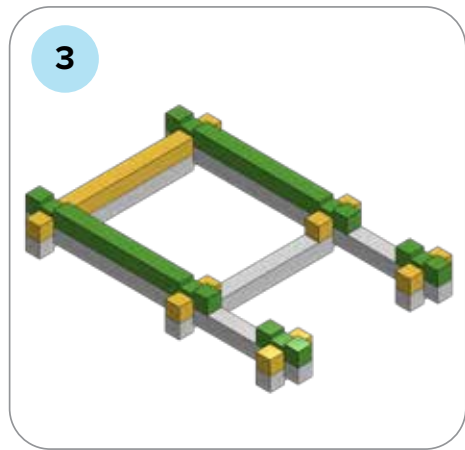
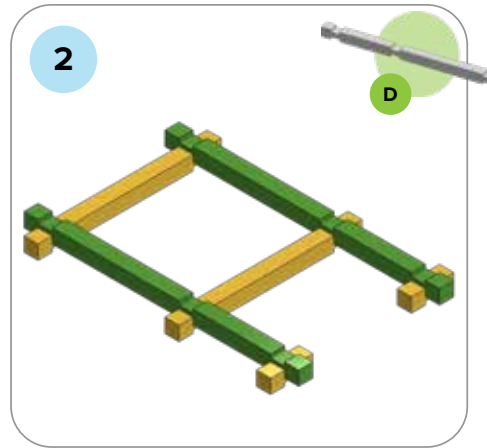
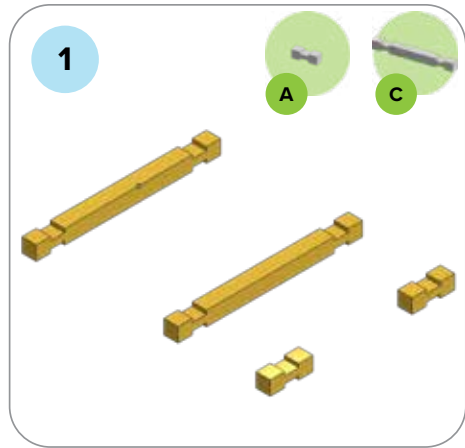
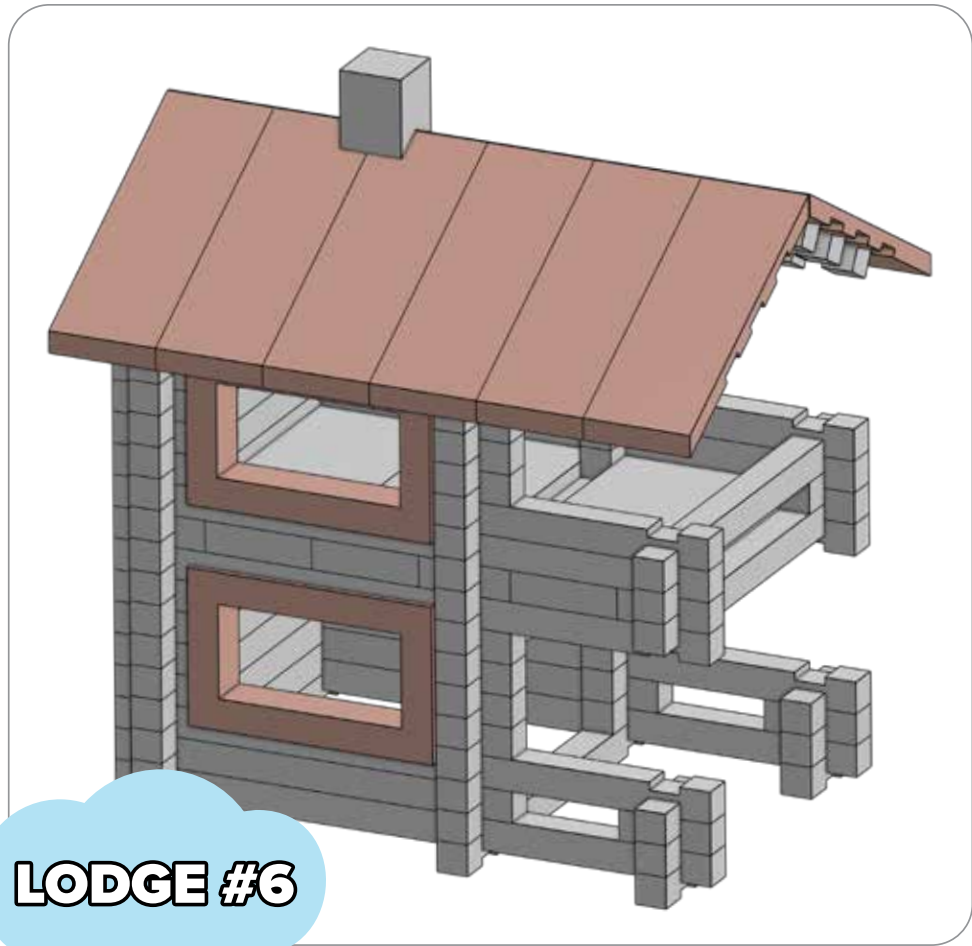

9

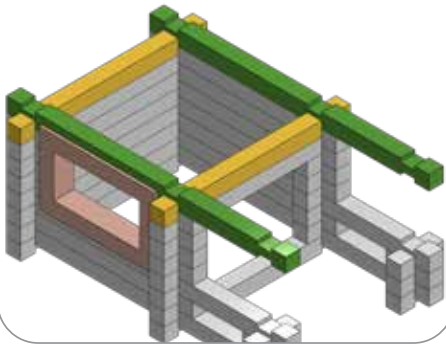

10

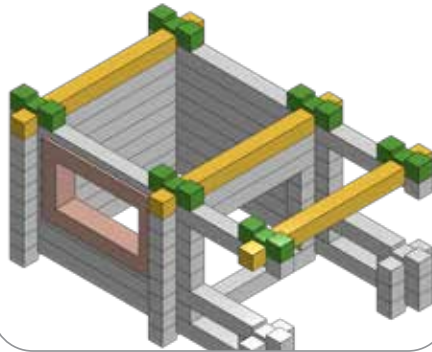

11

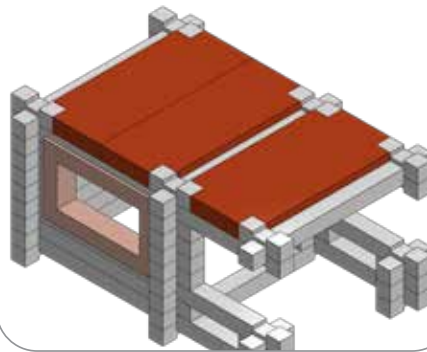

12

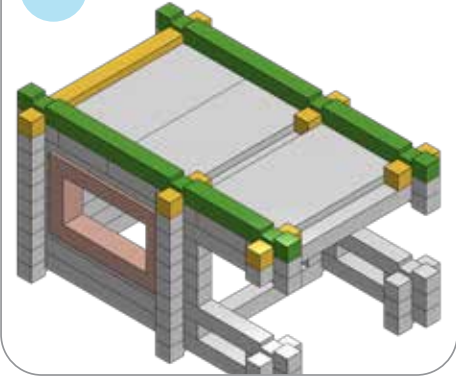

13

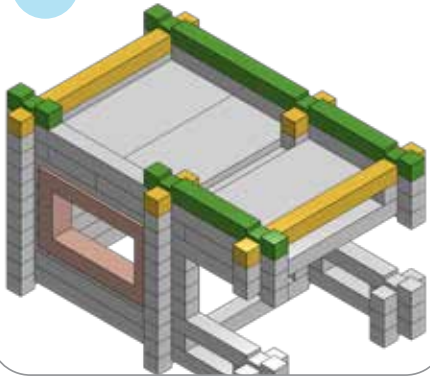

14

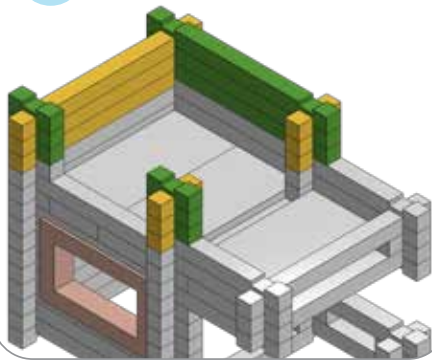

15

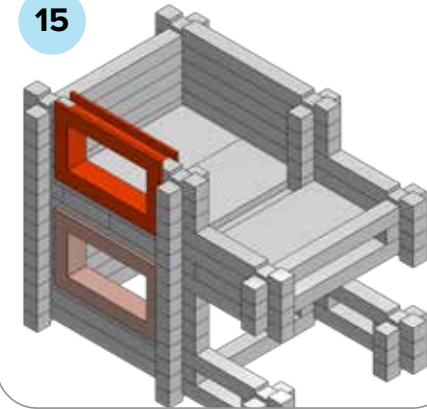

16

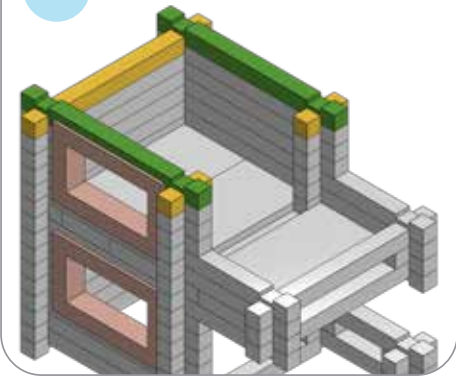

17

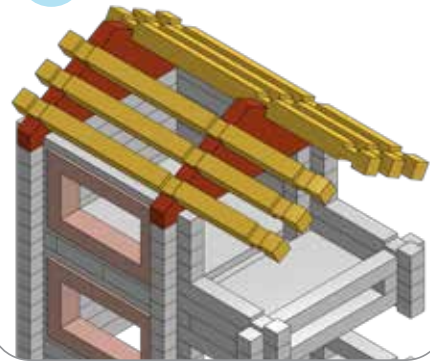

18

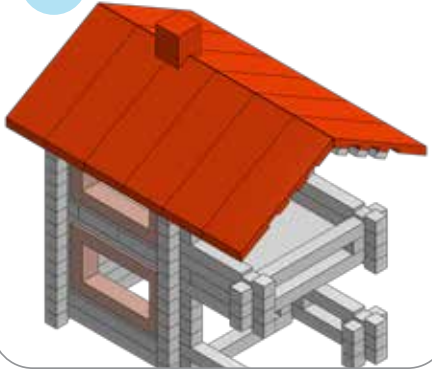

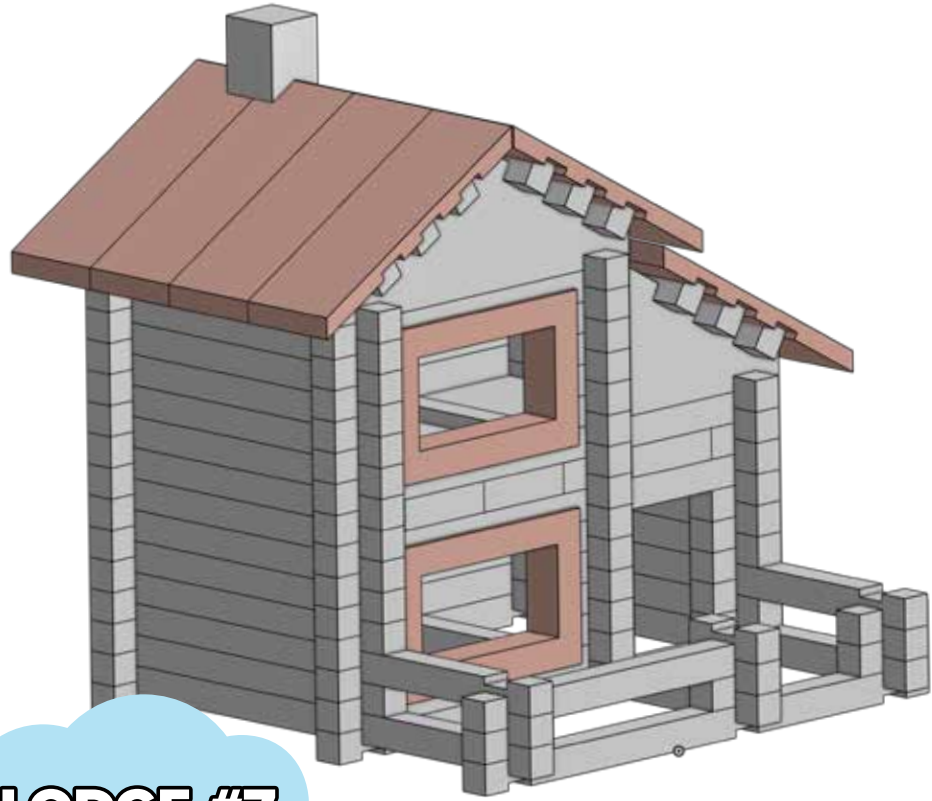

LODGE #7

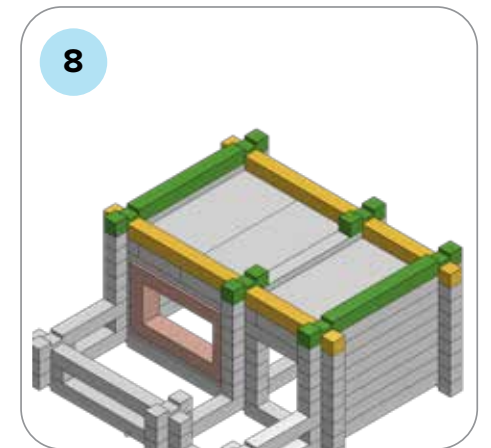
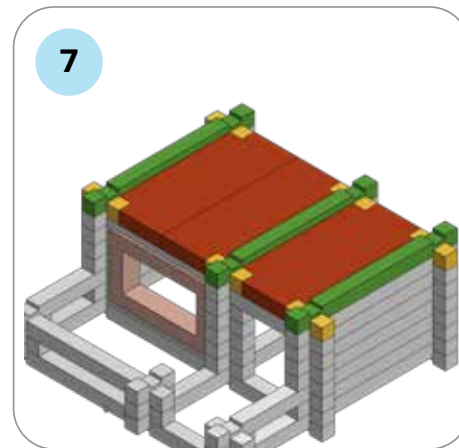
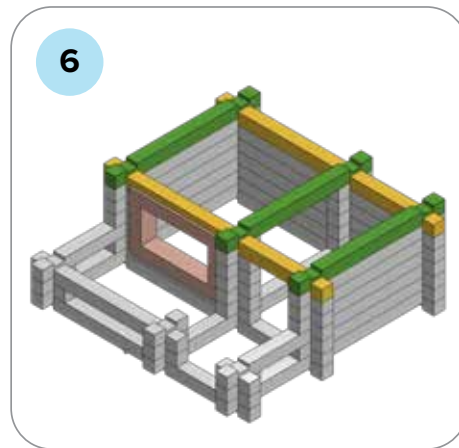
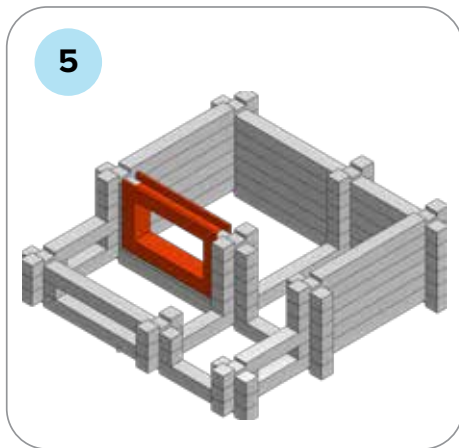
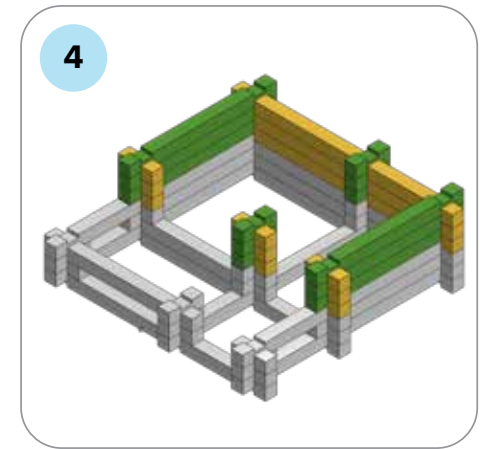
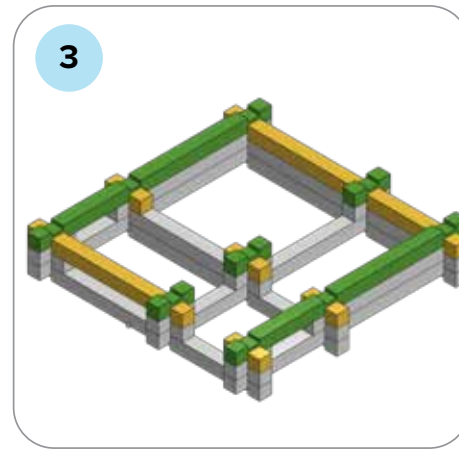
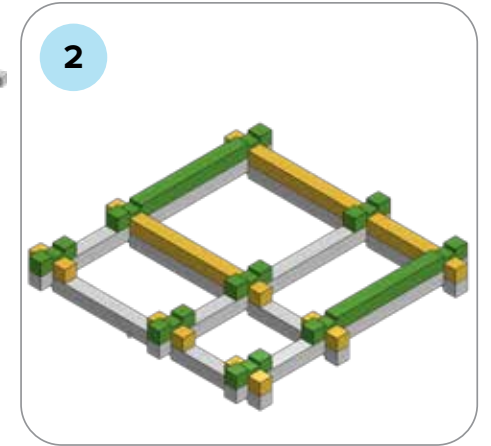
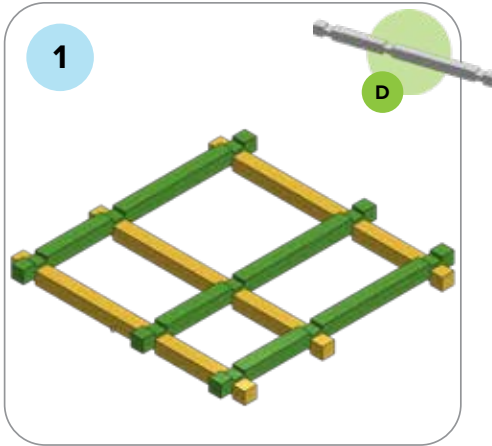

9

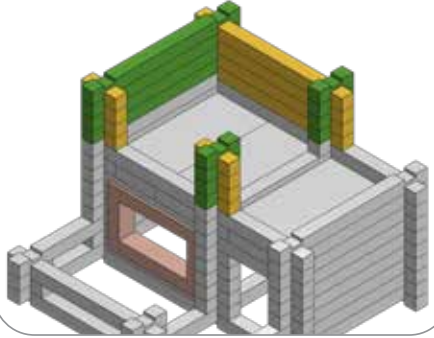

10

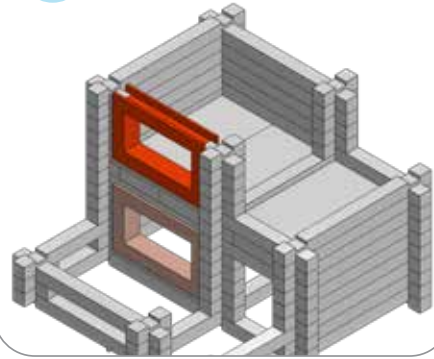

11

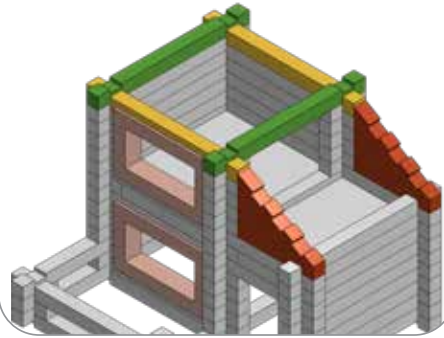

12

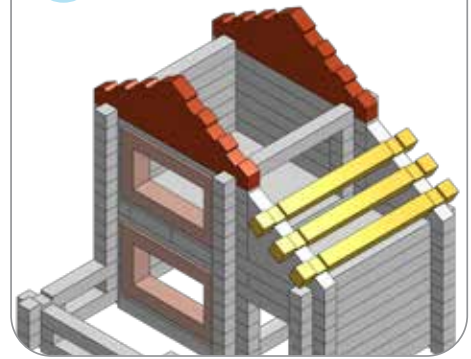

13

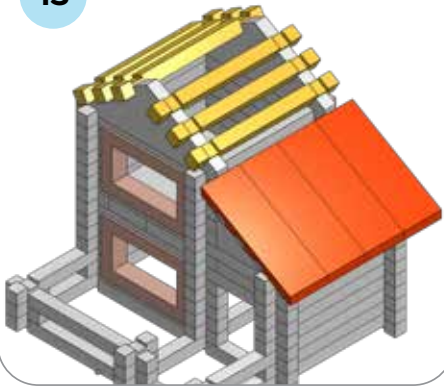

14



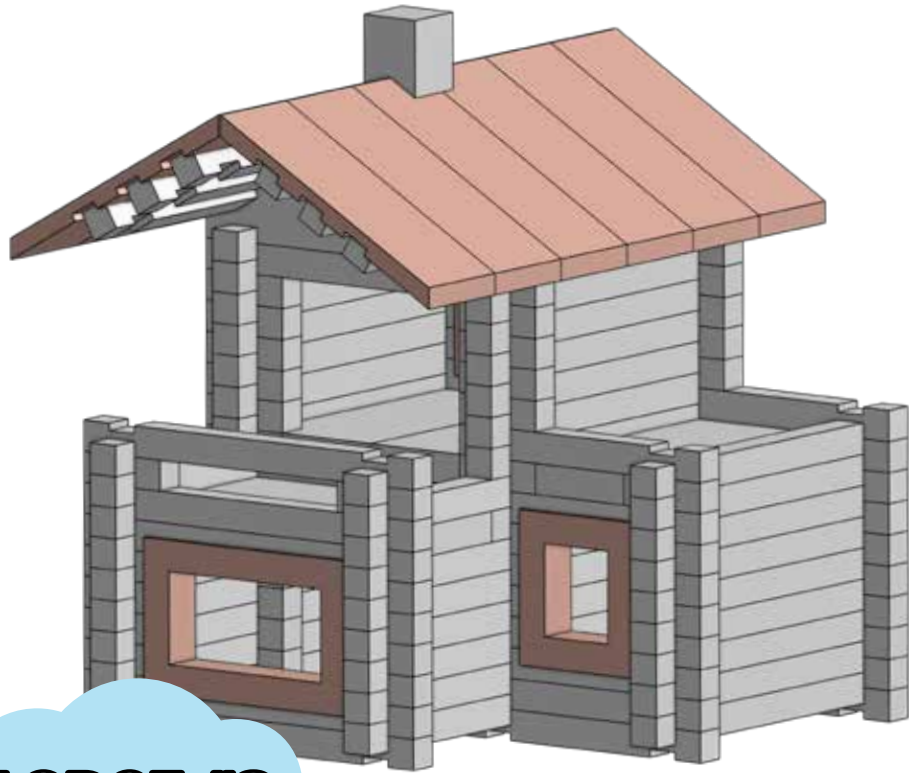

LODGE #8

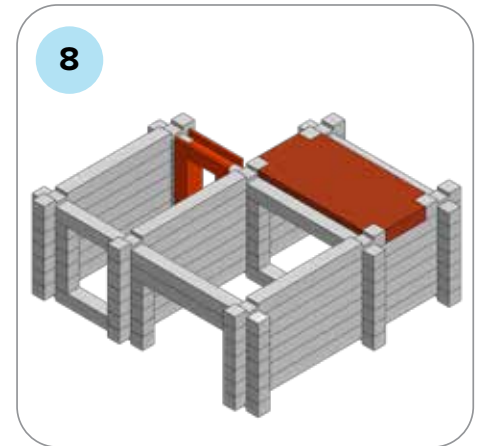
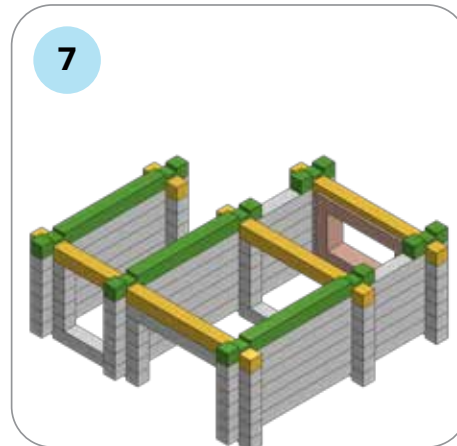
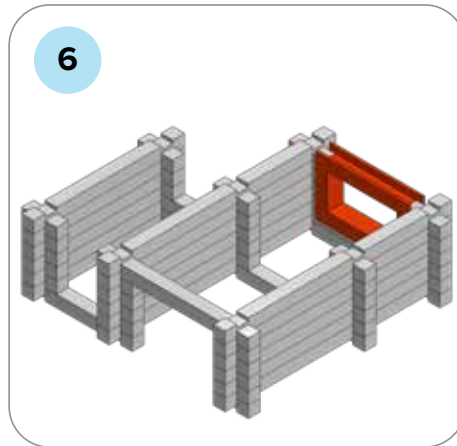
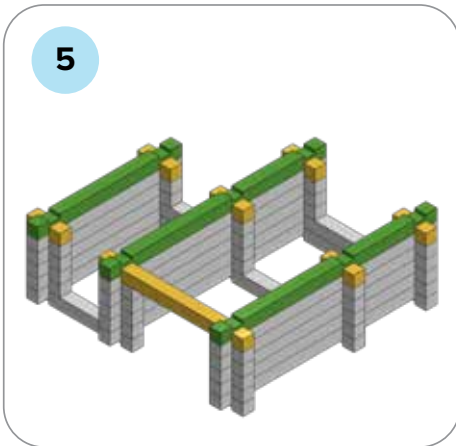
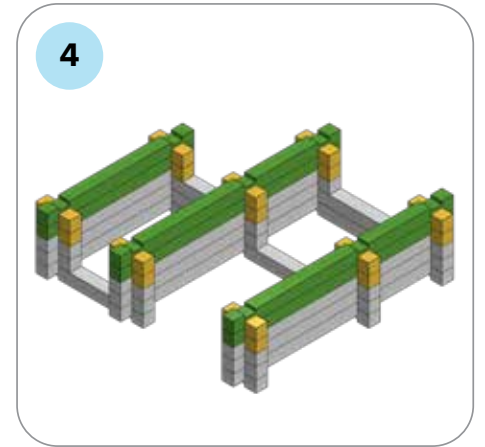
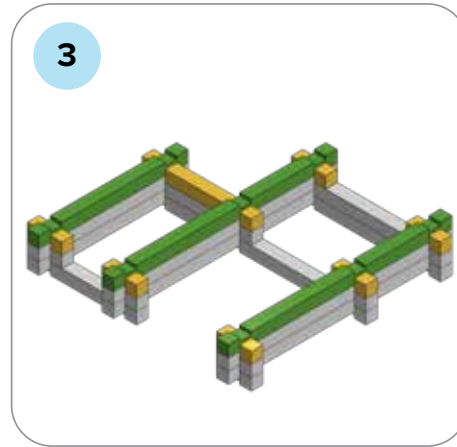
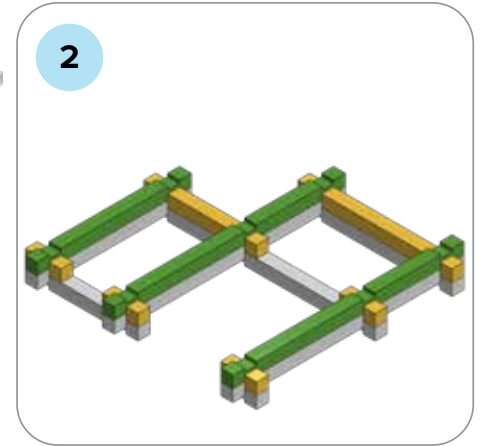
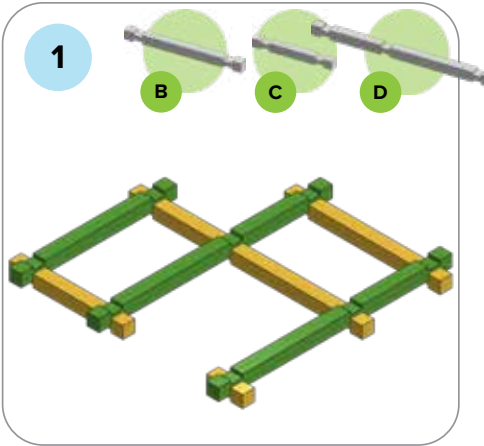

9

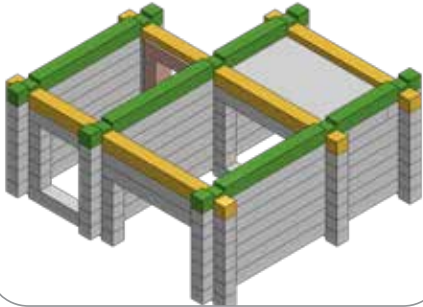

10

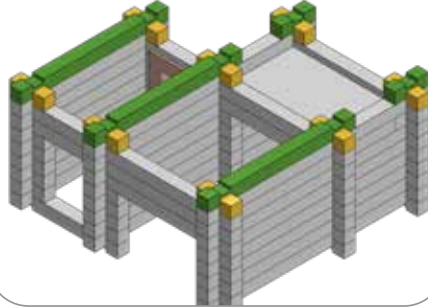

11

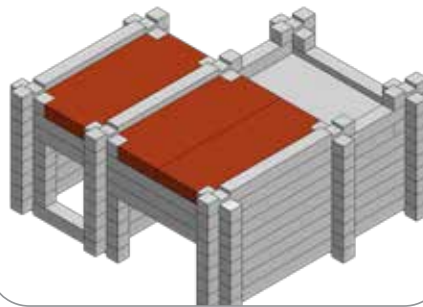

12

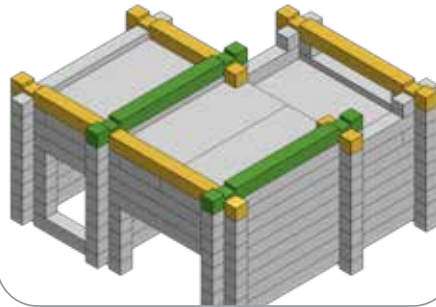

13

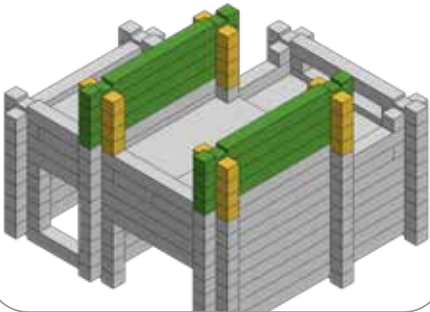

14

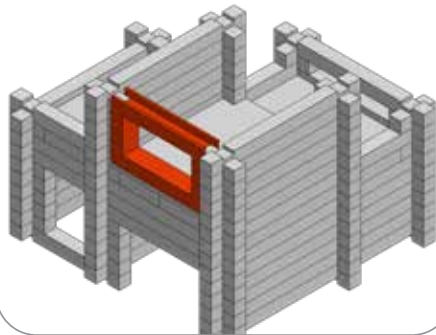

15

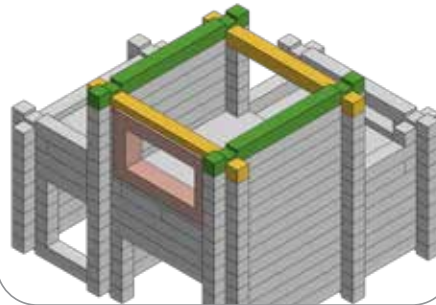

16

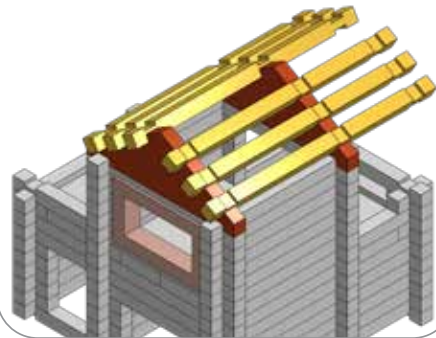

17





LODGE #9

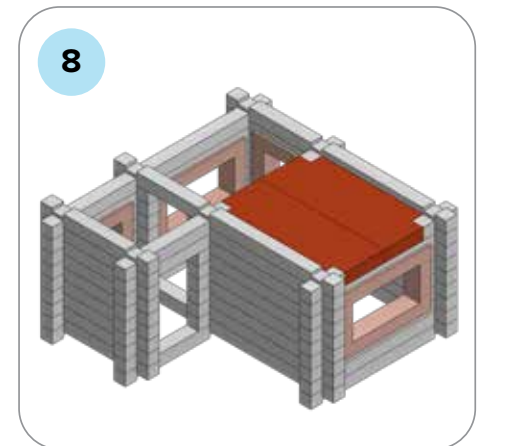
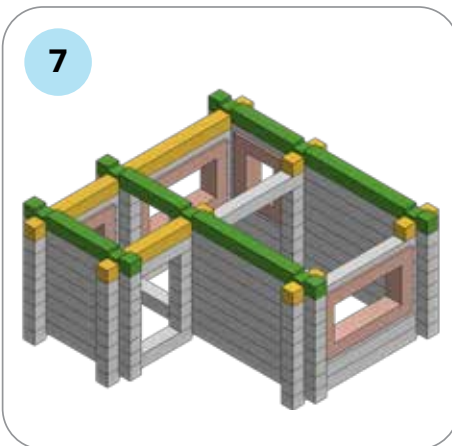
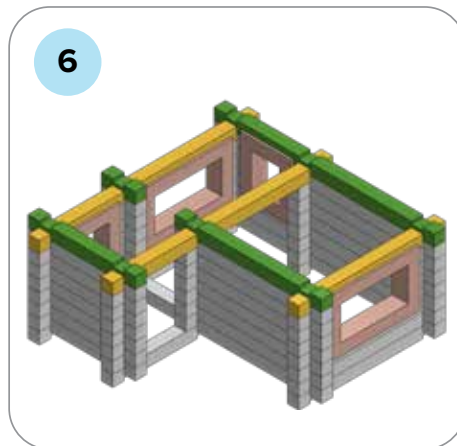
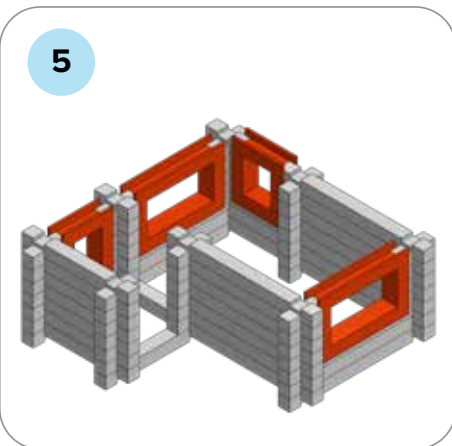
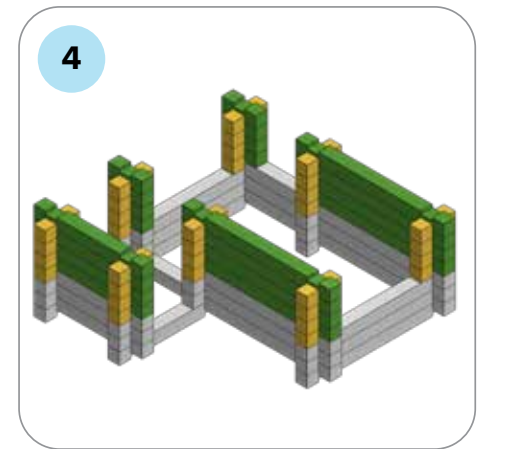
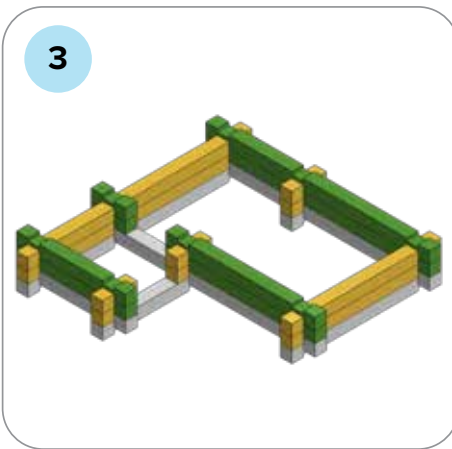
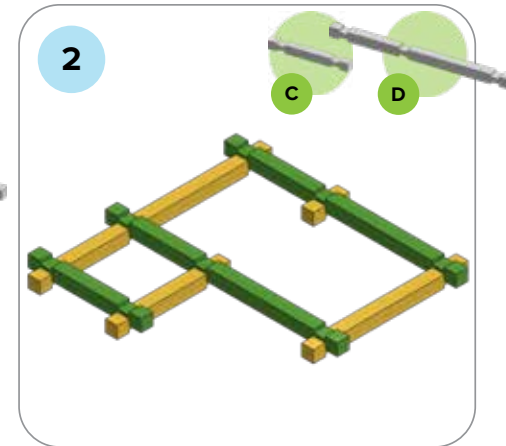
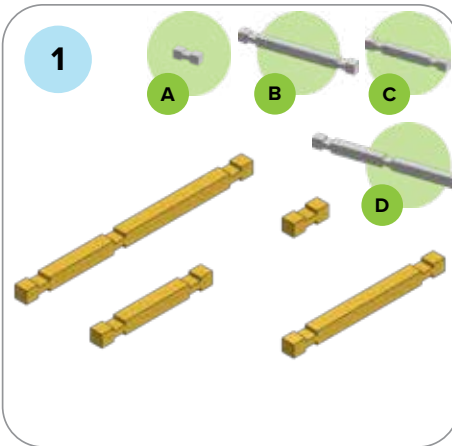

9

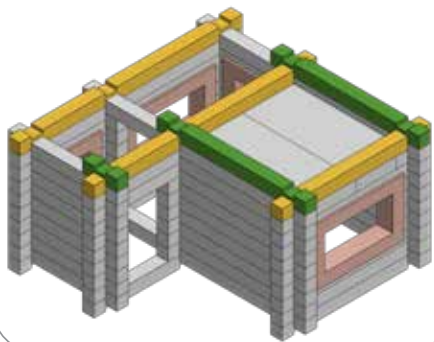

10

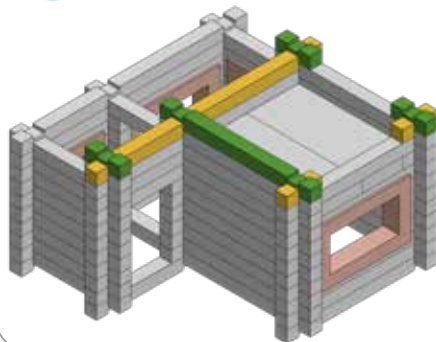

11

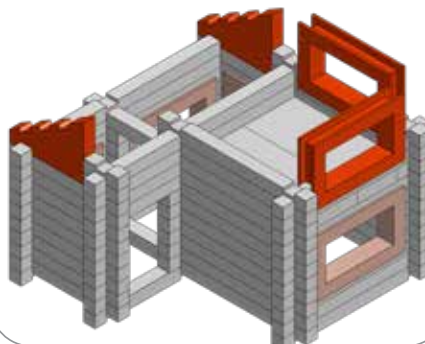

12

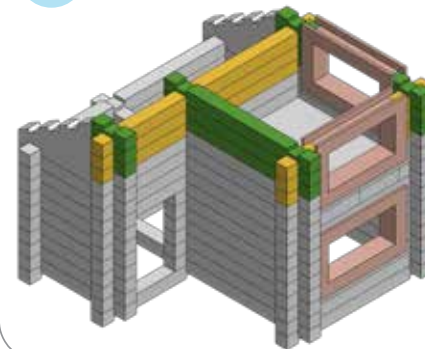

13

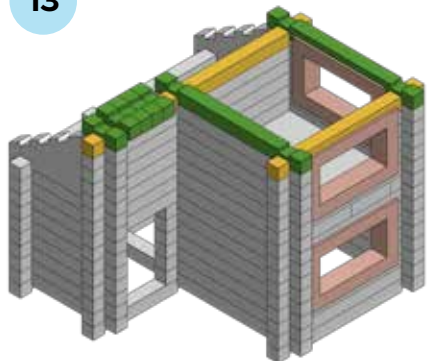

14

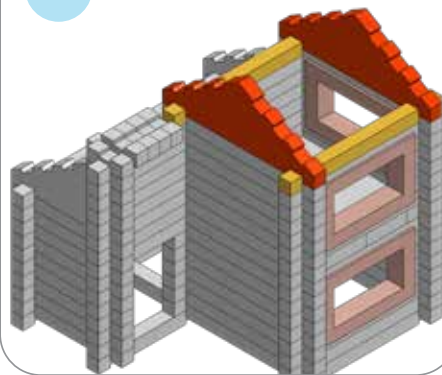

15

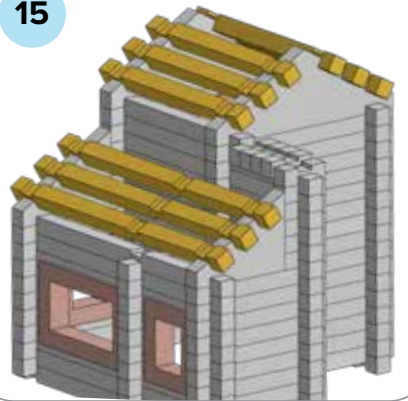

16

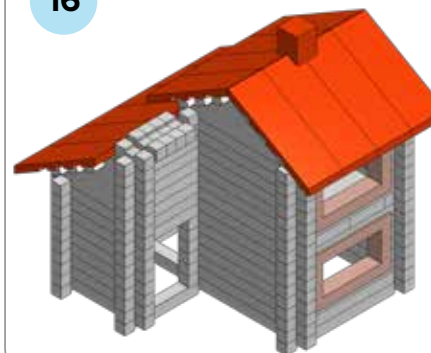

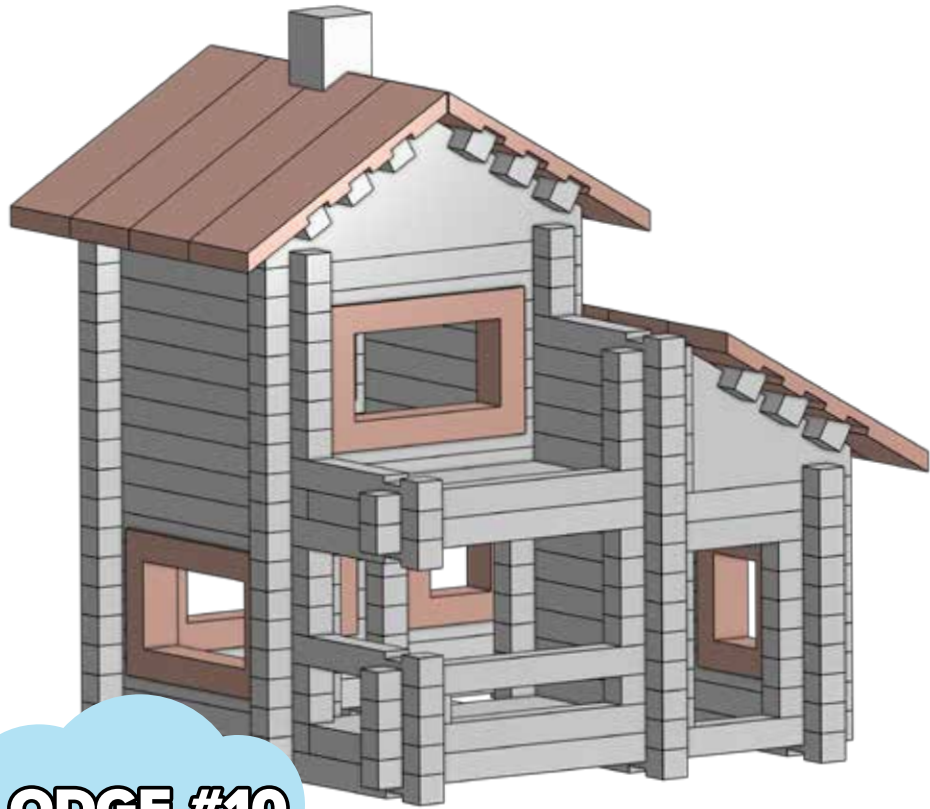

LODGE #10

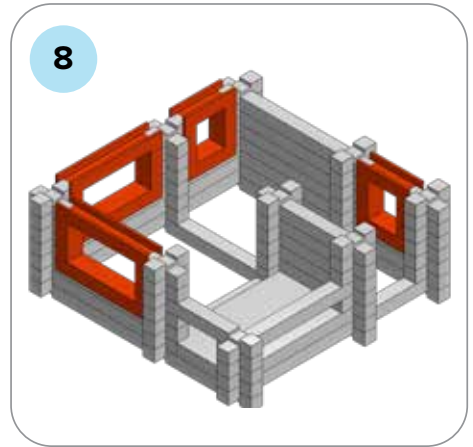
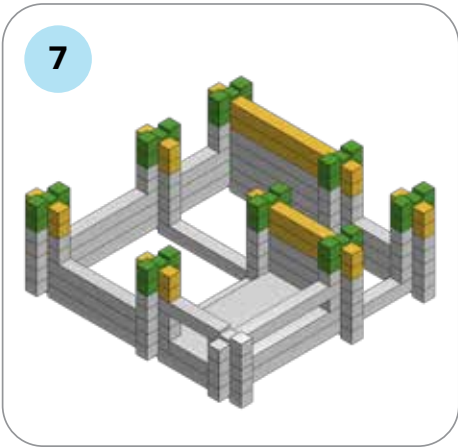
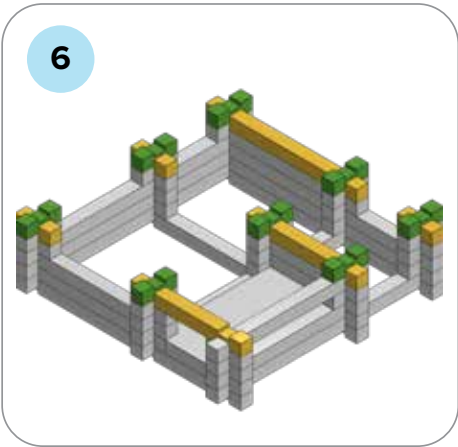
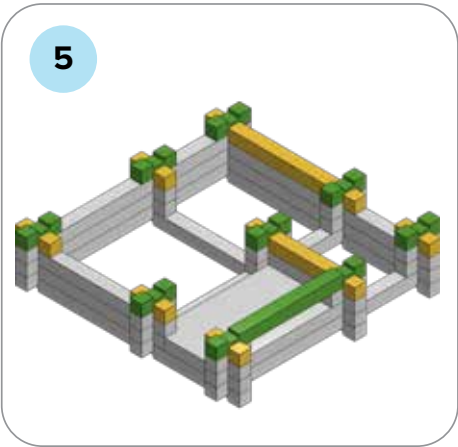
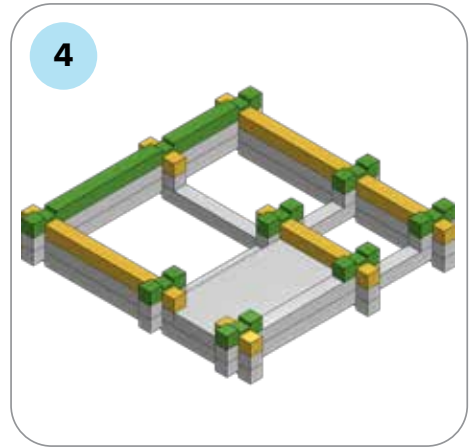
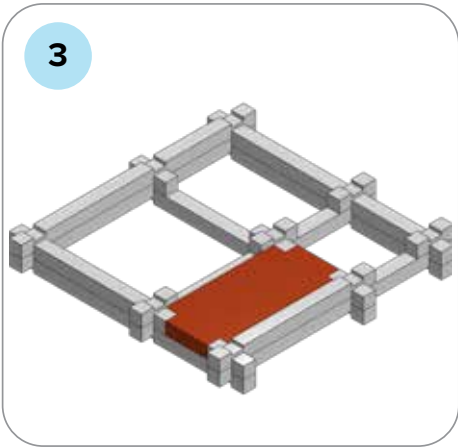
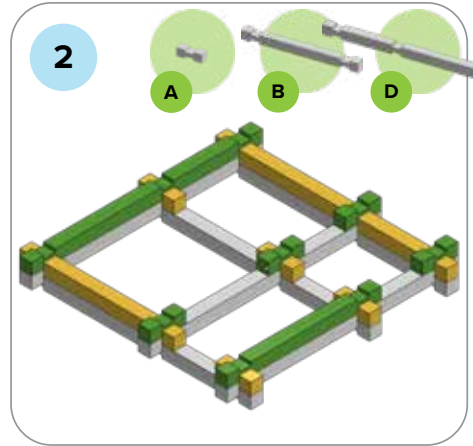
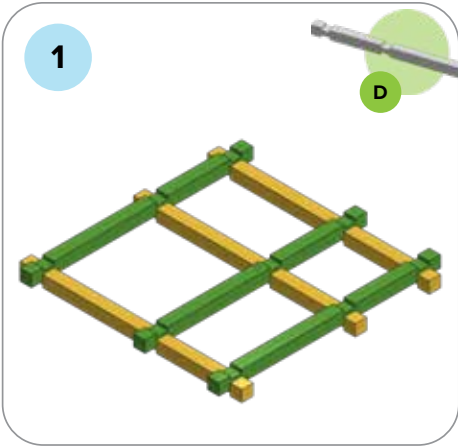

9

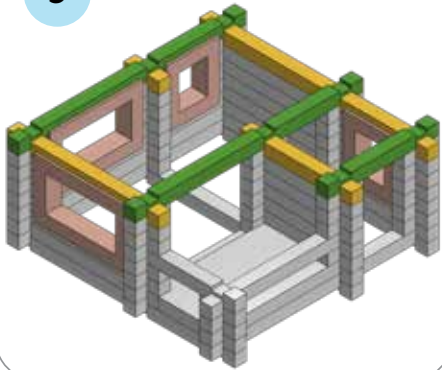

10

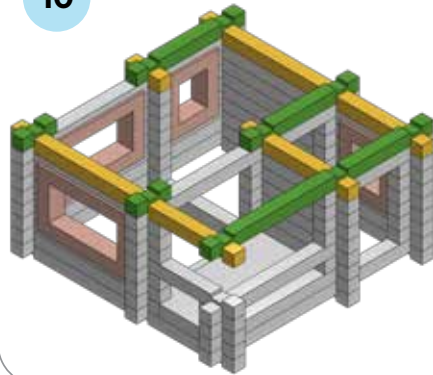

11

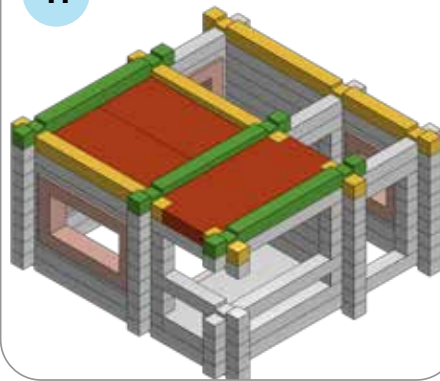

12

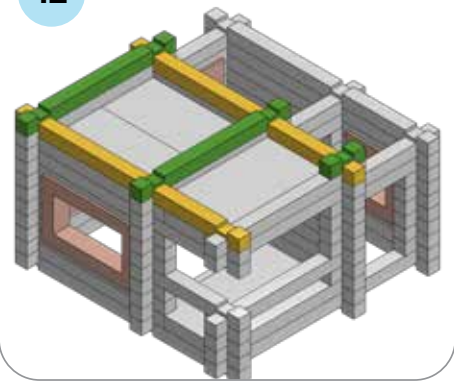

13

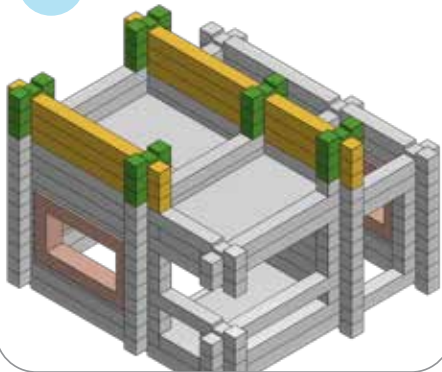

14

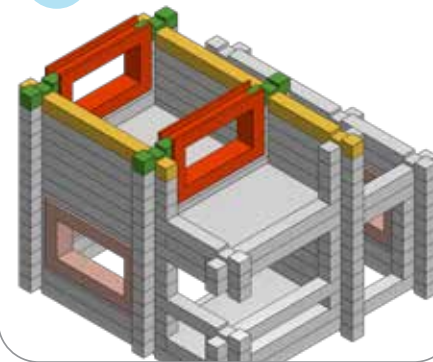

15

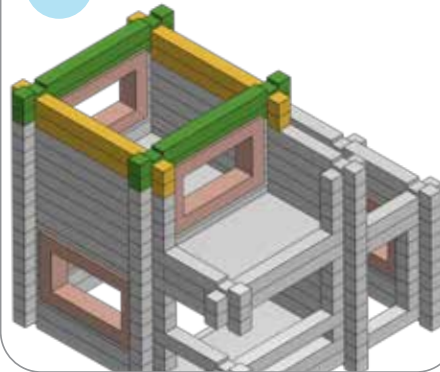

16

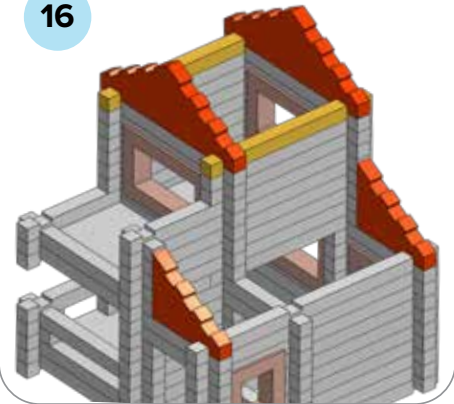

17

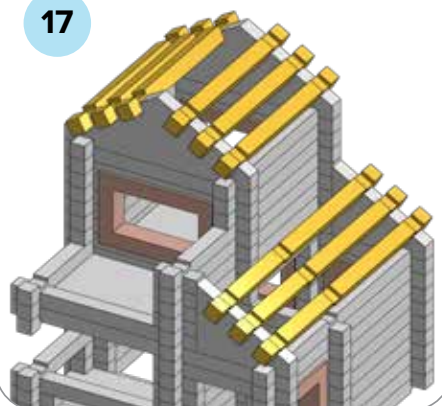

18

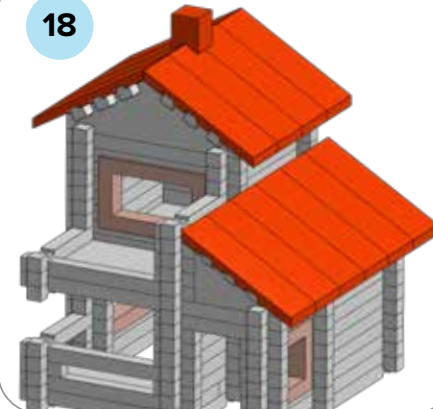



LOG-O-LODGE TOYS INC.

loglodgetoys.com