

INSTALLATION INSTRUCTIONS C-VS-0419-ESC

Vehicle specific console for the 2020-2023 Ford Escape

TOOLS REQUIRED:

Phillips Screw Driver Standard Socket set Metric Socket set T-20 Torx bit
 Panel removal tool

PARTS and MOUNTING HARDWARE:

<u>QTY</u>	<u>DESCRIPTION</u>	<u>PART#</u>
2	Cross support for floor brackets	13368
1	Foam block off for center HVAC vent duct	12457
2	Speaker grills	23047
1	DS forward floor mounting bracket	25297
1	PS forward floor mounting bracket	25298
1	DS mid floor mounting bracket	25299
1	PS mid floor mounting bracket	25300
1	Shifter and AUX plate	25304
1	Mode switch bracket	25308
1	Rear mounting bracket	25309

25578 – Hardware kit

6	#8 Torx head console screw	13405
20	1/4" serrated nut	16013
7	10-32 Keps nut	16017
16	1/4" x 1/2" Carriage bolt	16222
4	1/4" x 3/4" Carriage bolt	16223
14	10-32 x 1/2" machine screw	16399
1	1.75" x 3.30" Blank plate	13072
2	#8-18 X 3/8 PFHMS	16425

Note:

2022+ Model year only has one module that includes both USB-A and USB-C plugs. A blank plate and screws are provided to cover second cutout.

Always!

- Read all instructions before installing any Havis, Inc. products.
- **Check for obstructions (Wires, brake lines, fuel tank, etc.) before drilling any holes!**
 - Use hardware provided with install kit

C-VS-0419-ESC

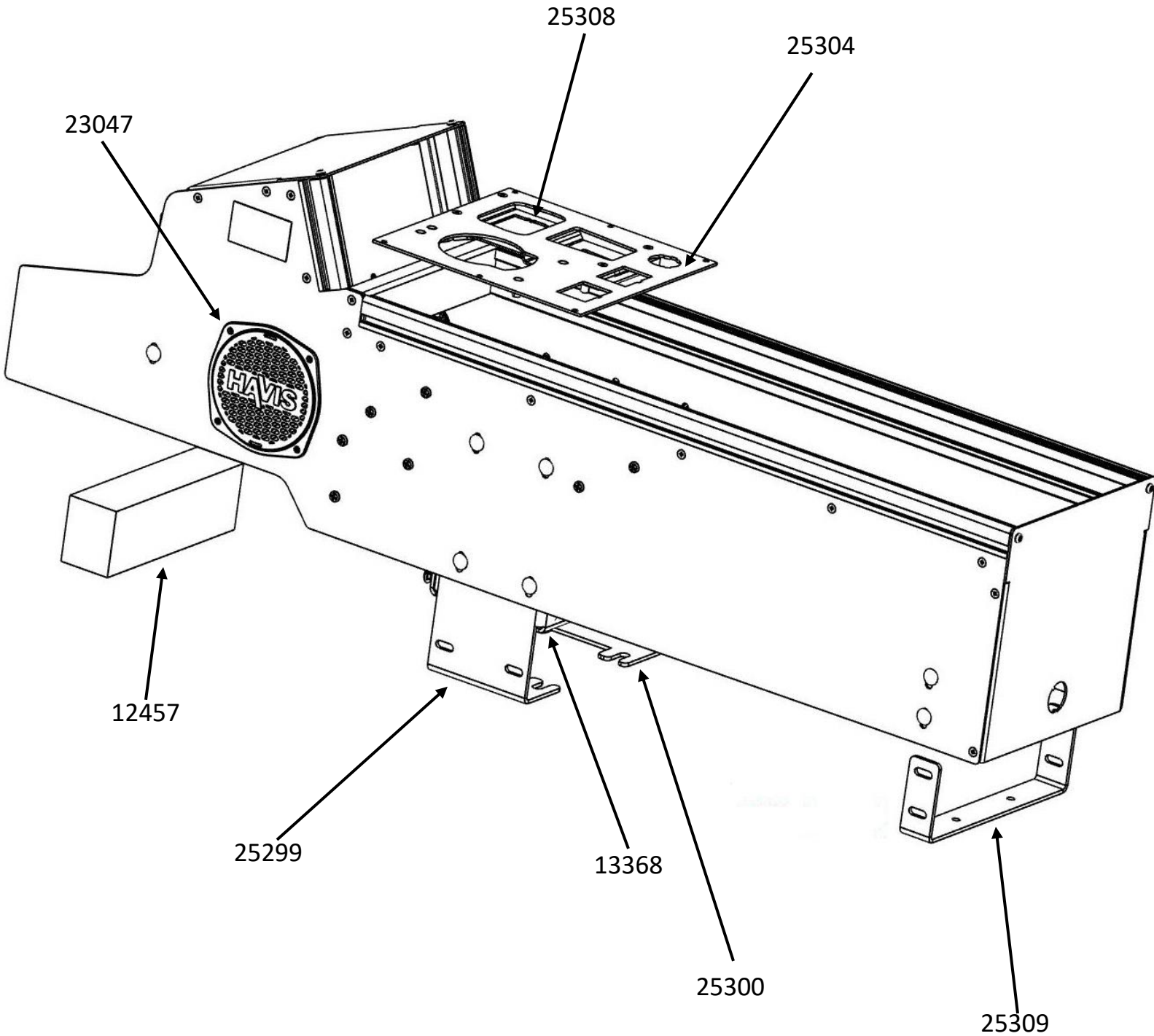



View of Escape interior prior to install



Remove cover from lower driver side panel.
Unbolt the 13mm OEM fastener and set aside.



Lift up center shifter plate by gently prying from the front and lifting up.



Unplug all harnesses from OEM modules.



Remove side trim panels from OEM console.
Remove 10mm head fasteners from lower side of
OEM console.



Remove 10mm head fastener from center, USB
plate.



Unplug USB, 12v socket, and key sense module.
Remove key sense module.



Remove (2) 8mm head fasteners from front section of console.



Unsnap rear section of console and remove (2) 10mm head fasteners. Remove OEM console from vehicle.



Remove OEM USB plug from rear console plate.

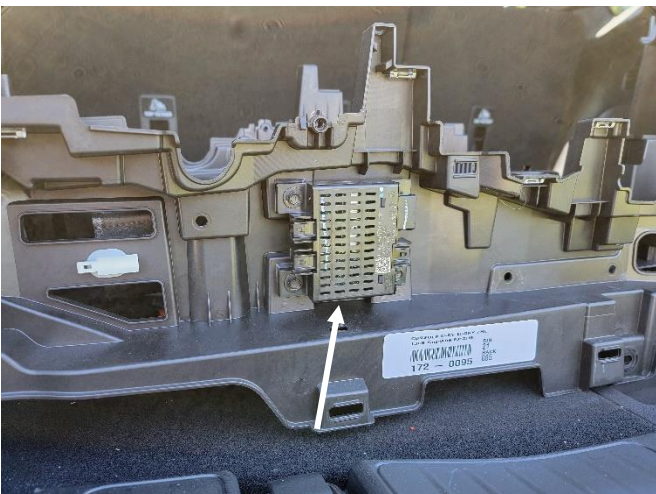

Remove USB module from side of OEM console along with the entire harness.



Remove secondary key sense module from top of OEM console.

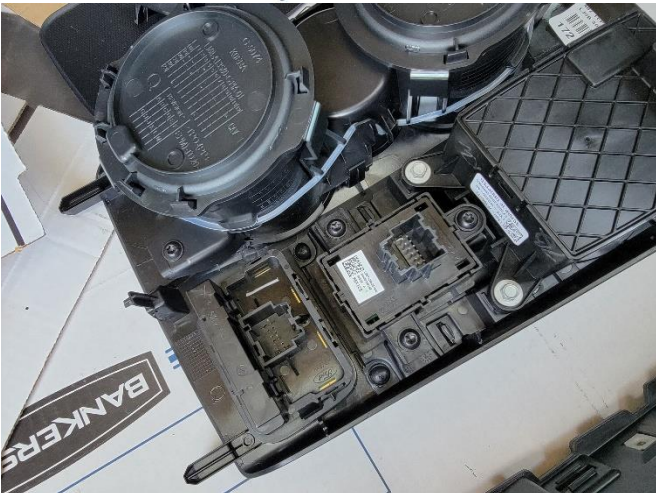

Remove Emergency brake and Mode switch from console shift plate.

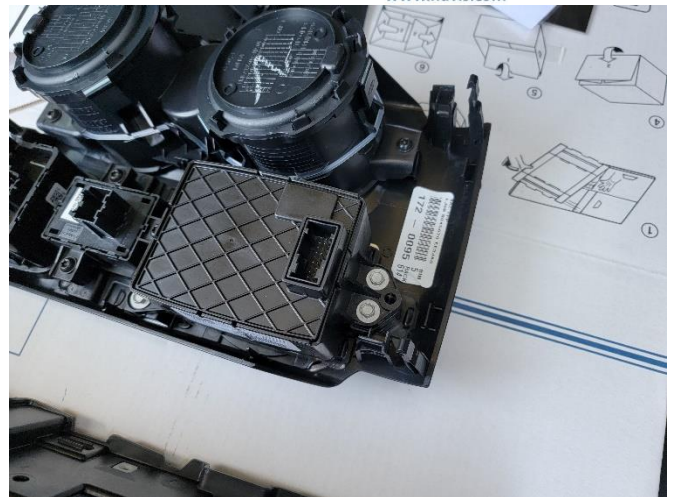

Remove shifter module from console shift plate.



Remove USB plate and 12v socket from forward console plate.

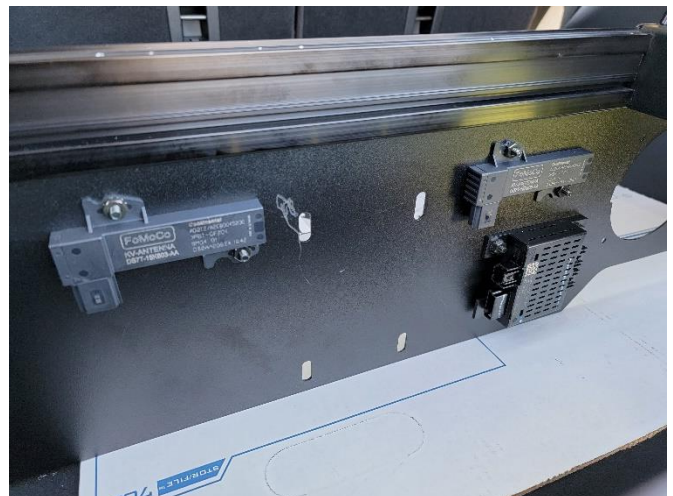

Install USB module and both key sense modules on inside of Havis console using supplied 10-32 x 1/2" machine screws and keps nuts.



Remove OEM rear mounting bracket from floor of vehicle.

10mm socket



Loosen (4) 10mm head nuts from mid-section of transmission hump.



Remove 13mm bolt from brace at front of vehicle on passenger side.



Install Passenger side forward mounting bracket.



Using bolt removed at the beginning of the install, add Driver side forward mounting bracket.

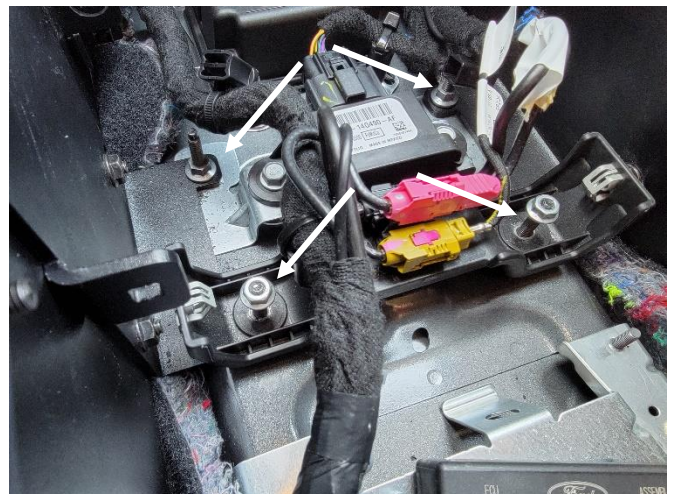

Place DS & PS side mid-mounting brackets on OEM center floor studs.



Place console in vehicle. Slide up to dash.



Attach to mid-mounting brackets to housing with 1/4" x 3/4" carriage bolts.



Repeat for other side.



Attach cross braces onto floor mounting brackets with 1/4" x 1/2" Carriage bolts and nuts.



Attach rear-mounting bracket to floor studs at rear of console. Tighten using OEM nuts.



Attach to front, floor mounting brackets using 1/4" x 3/4" carriage bolts and serrated nuts.



Using supplied foam block, install into center vent tube. Be sure to fully block off vent. Add duct tape if desired to ensure a good seal.



The front of the console should be lined up with inserts for OEM fasteners.



Reinstall previously removed OEM fasteners through front of console.



Reinstall previously removed interior OEM console items.



Plug modules back in that had been relocated to side of the console.



Install shifter into console plate with supplied 10-32 x 1/2" machine screws.



Snap Mode control into Mode switch bracket. Attach emergency brake switch using 10-32 x 1/2" screws.

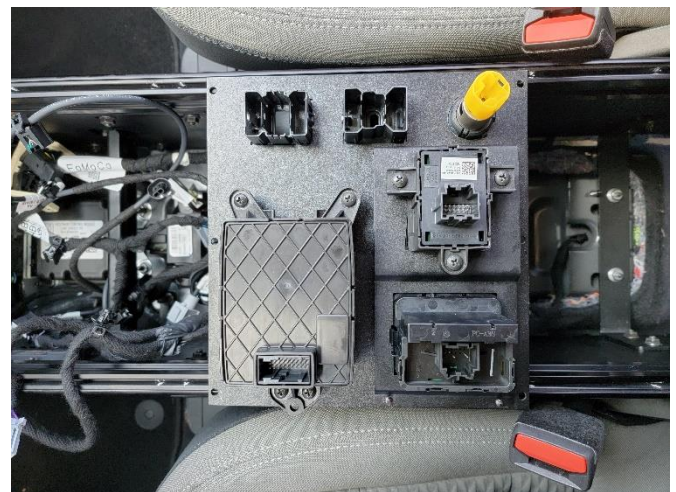

Install remaining USB and 12v sockets into shifter plate.



Attach Mode plate to shifter plate using flat head screws.



Verify all modules are attached, snug and no buttons are binding.

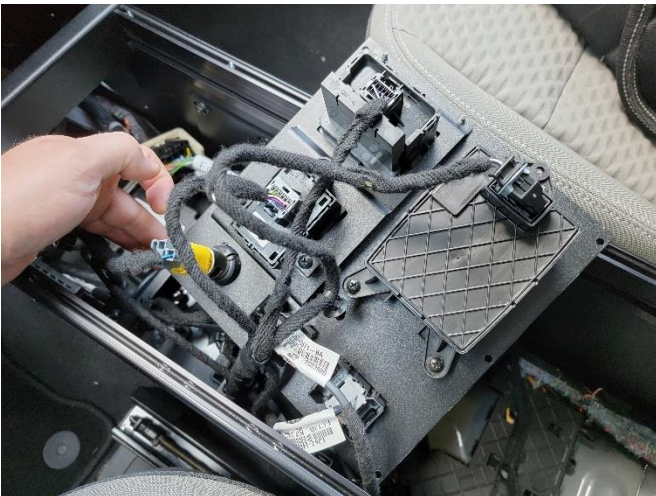

Plug in all modules.



Install shifter plate on console using (6) T-20 Torx head screws.



Wire and mount equipment.

Note: 2022 Model year only has one module that includes both USB-A and USB-C plugs. A blank plate and screws are provided to cover second cutout.



Installation is now complete.