

# MOD

*In-wall, wall hung  
odourless toilet suite*

*Milu*  
odourless  
by expella™

Mod from the Milu Odourless range is a sleek, modern and compact in-wall toilet with clean lines.









The toilet features a patented in-built ventilation system that quietly extracts odours from the toilet bowl and discharges them directly into the sewer before they can be released into the bathroom.

The Milu Odourless range is manufactured in high quality vitreous china and incorporates rimless flush technology, making the toilets easy to clean and maintain.

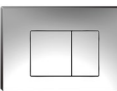

## PRODUCT SPECIFICATIONS

<b>Recommended use</b>	Domestic, hotel, commercial
<b>Water rating</b>	WELS 4 Star at 4.5L flush and 3L flush. LIC. 1848
<b>Compliance</b>	Complies with Australian Standards - AS1172.1, AS1172.2, ATSS200.425.425:2009
<b>Fixing</b>	Toilet pan screwed through wall to frame. Fixings included.
<b>Rim configuration</b>	Rimless
<b>Trap configuration</b>	Universal (S Trap included)
<b>Material</b>	Vitreous china
<b>Seat</b>	Soft close, quick release
<b>Water inlet</b>	Top left
<b>Power supply</b>	12 volt, 1.5amp (transformer provided).
<b>Fan</b>	Expella OCD

Flush plate options	 Round black	 Round chrome	 Round white
	 Soft black	 Soft chrome	 Soft white
	 Square black	 Square chrome	 Square white

# MOD

In-wall, wall hung  
odourless toilet suite

## DIMENSIONS AND SET-OUT (all measurement specified in millimetres)

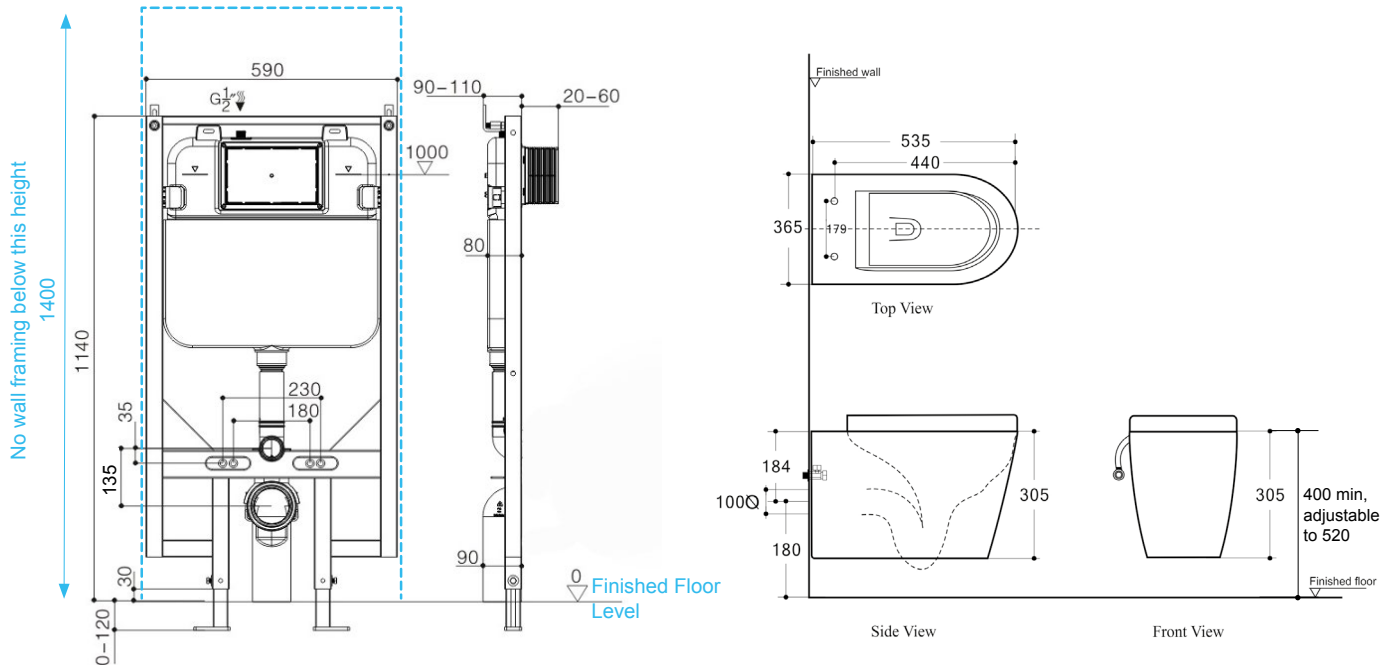

## HOW IT WORKS

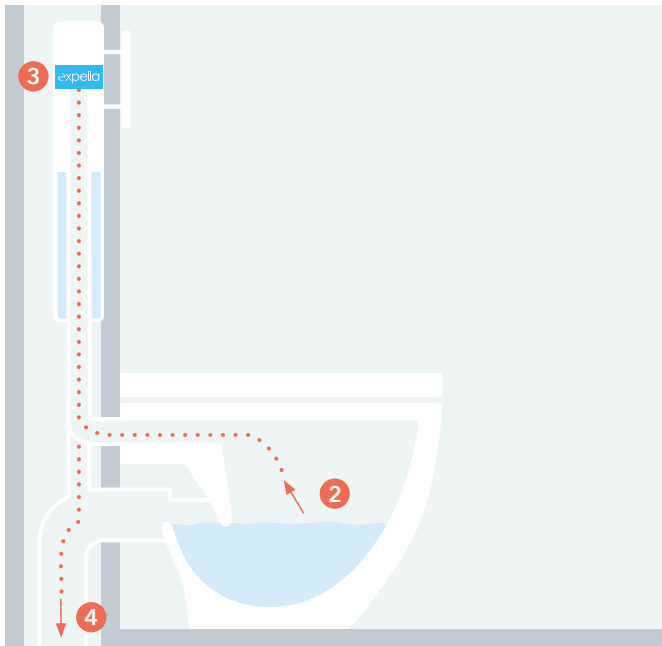

- 1 Expella's patented Odour Control Device (OCD) is hidden inside the cistern, it is activated by either a:
  - Light switch\*
  - Manual switch\*
  - Automatic sensor switch.\*
- 2 The OCD contains an in-built extraction fan that draws odours from the bowl through the flush pipe.
- 3 Odours pass through the OCD, opening a non return valve that prevents odours returning.
- 4 Odours are discharged to the sewer.

\* Switching not included

**WaterMark**  
WMKA 23157

Patent: AU2007204583, AU2018000006

**Milu**  
odourless  
by expella™