

EE21

Tasman Endeavour

Oliveri®

LEFT HAND BOWL

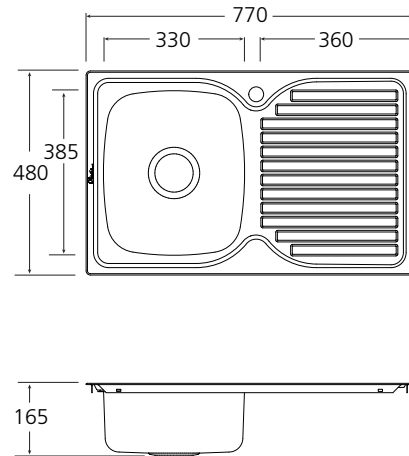

INCLUDED ACCESSORIES

AC14

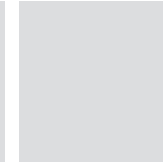
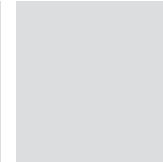
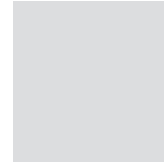
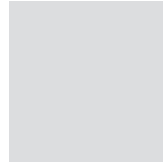
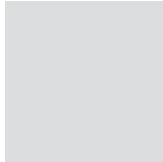

RECOMMENDED TAPWARE

PS113



WELS 4 star
7.5 L per min

MA4010



WELS 4 star
7.5 L per min

OPTIONAL ACCESSORIES

AC01

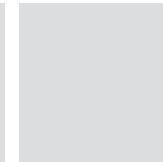
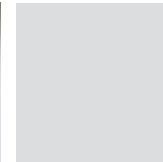
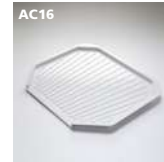

SPECIFICATIONS

Description

Single bowl inset sink with drainer

Sink Size

770W x 480H

Main Bowl

330W x 385H x 155D / 17L

Construction

2 piece, bowls & drainer seam welded

Material

304 grade, 18/10 polished stainless steel (0.8mm thick)

Installation

Topmount only

Fixings

Adjustable clips supplied, sealing gasket fitted

Cut Out Template

750 x 460 x 15mm radius

Min Cabinet Size

500mm

Tap holes

1 tap hole (for no tap hole order product code 'EE20')

Waste fittings

1 x 90mm basket waste included

Overflow

Special order option available

Carton Size

800 x 520 x 190mm

Weight

5.0kg

Warranty

Lifetime manufacturer's warranty (refer to oliverisinks.com)

For more information call **1300 13 7465** or visit **www.oliverisinks.com**

