









Model Code: STQ450SLCO

Included Accessories

 SCA-STQ450S	 CNA-3-842CO	 DGQ4540CO	 WKCB-CO	 UMG6 x 2
 ICM6 x 2	 6020Q/OFLOW4CO			

Optional Accessories

Dimensions

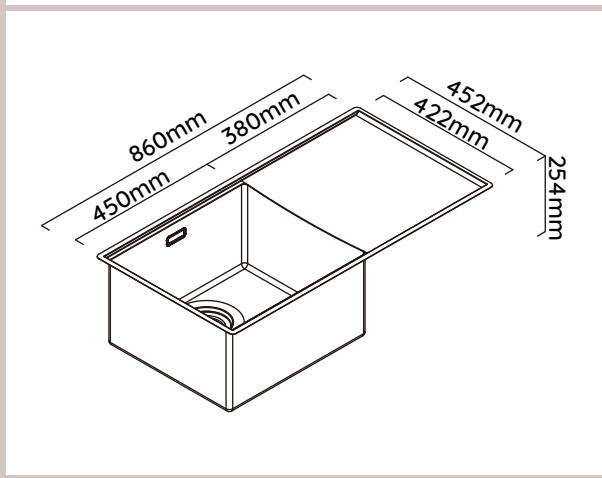

Specifications

Description	Boutique Lugano 860 x 452 LHB Artisan Copper
Overall Sink Size	860mm x 452mm x 254mm deep
Bowl Dimensions	450mm x 400mm x 254mm deep
Drainer Length	380mm
Technic	Fabrication
Material	1.2mm Stainless Steel SUS304

Installation

Fixings	Inset & Undermount clips supplied
Template	Supplied
Min Cabinet Size	900mm
Waste Holes	1 x 90mm round Compatible with waste disposal
Sealing Strip	N/A

Plumbing

Waste Fittings	1 x (90mm x 2") basket wastes included
Overflow	Supplied

Packaging

Carton Type	Eco packaging & Individual carton
Gross Weight	17.5Kg
Carton Size	940mm x 350mm x 555mm
Pack QTY	1

SURFACE FINISH



WASTE KIT

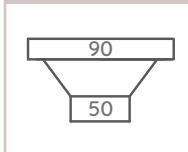

MATERIAL

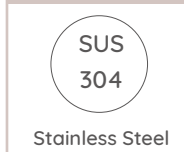

INSTALLATION OPTIONS

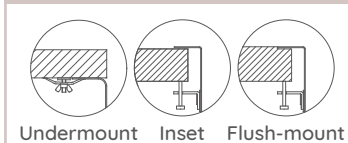

PROFILE

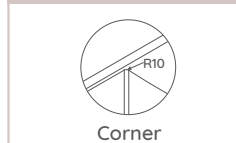

Abey are Australia's leaders in sinkware, designing and manufacturing to the world's highest quality specifications as well as sourcing and bringing you Europe's very best, leading edge designs – practical, affordable, inspirational, stylish, timeless or cutting edge. When you buy an Abey stainless steel sink you receive the highest quality and a 25 year warranty. Abey and the manufacturer are continually seeking ways to improve the design specifications, aesthetic and production techniques of the products. As a result, alterations to the specifications and dimensions of the products and designs occur continually.