

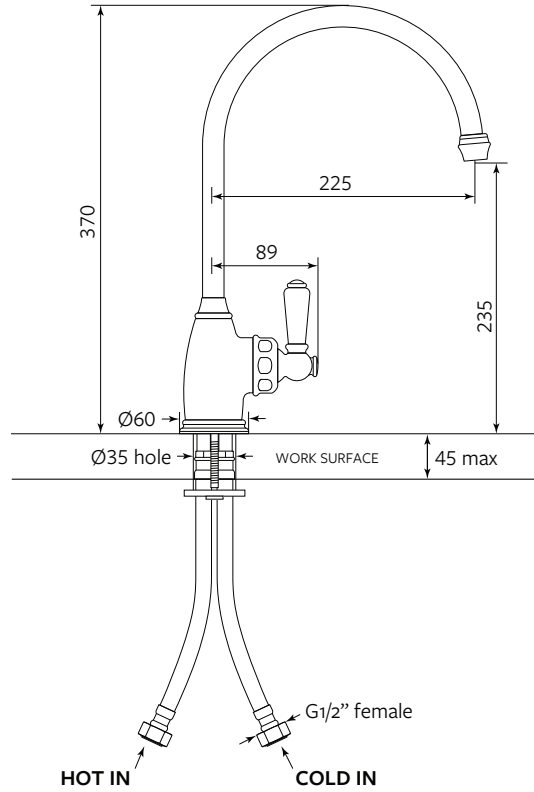







Yarrow

AUSH.4341



MODEL	CODE
 Yarrow - Chrome	AUSH.4341CPWPC
 Yarrow - Nickel	AUSH.4341NIWPC
 Yarrow - Pewter	AUSH.4341PFWPC
 Yarrow - English Bronze	AUSH.4341EBWPC
 Yarrow - Satin Brass	AUSH.4341SBWPC
 Yarrow - Polished Brass	AUSH.4341BRWPC
 Yarrow - Gold (<i>special order</i>)	AUSH.4341IGWPC

Also Available: Yarrow with Spray Rinse (AUSH.4346) Please note, spray rinse cannot be added to the standard mixer later.

Features include:

- Handcrafted in the United Kingdom using DZR brass
- White porcelain handle with Shaws insignia indice
- Kerox 40mm ceramic cartridge
- Vernier insert for accurate handle alignment
- 15 Year warranty. Please visit our website for individual finish warranties

Temperature range: Min 1°C. Max 70°C
 Working Pressure: Min 1 Bar/15psi. Max 5 Bar/75psi
 Packed Weight: 3.02kg
 Flow Rates: 1 Bar: 5.9L/min
 2 Bar: 9.7L/min
 3 Bar: 12.5L/min

