



DORSET
WOOLLISCROFT

The Safest Choice in Floor Tiles

SAFETY FLOOR TILE RANGE

FOREWORD

NOT ALL TILES ARE EQUAL

As a forensic engineer specialising primarily in slip, trip and fall accident prevention (stairs, steps, walkways, ramps, and abrupt surface transitions), slip resistance measurement, and the tractional evaluation of walkway surfaces, I have, over many years, become familiar with many manufacturers and suppliers of tiles from around the world whose operating and ethical standards varied greatly.

Tiles are universally popular, but be warned, not all tiles are made equally and it's important to know the differences. There's a lot more to buying a floor tile than finding a colour and pattern that will work. Every tile manufactured has an intended use, and that intended use is very important. Understand this and you should select the right tile for your project.

The most important things to consider for tiles for flooring are how slip resistant they are and their cleanability. The level of slip resistance required depends on two factors – the level of spills the floor will be subjected to and environmental requirements. The more the floor is exposed to spills, the higher the need is for a slip-resistant option. Environmental factors include the type of location where they will be installed and who will be walking on them. After installation, effective and correct cleaning can make the difference between a floor being or becoming a high or low slip risk.

Ceramic and porcelain tile manufacturers have developed slip resistant tiles by using various glazes, glaze additives and surface textures/patterns. Also tile size, grout joint spacing, and slope of the floor will affect the slip resistance. In addition, unglazed ceramic tiles have greater slip resistance than glazed tiles and are recommended for areas subjected to frequent water spills or heavy foot use.

Specifying materials for projects is made so much easier for architects and specifiers when they can be assured the information provided on the materials to be used is accurate.

The team at Dorset Woolliscroft are at the forefront in offering products that are honestly tested and documented, so there is no doubt as to an individual tile's specifications.

Often I am asked, 'who supplies the best tiles?'. But in my opinion it's not who supplies the best tiles, it's who provides the most accurate specification information that matters.

One word sums up my experience with Dorset Woolliscroft – it's 'trust'.

Terry Tyrrell Roberts
BSc. ISRRI, CTIOA, WSO

Terry Tyrrell Roberts is an independent safety advisor with a worldwide client base. He advises corporate multi-national organisations on the suitability and risks associated with flooring in commercial, retail and residential environments.

04-11	Welcome / Introduction
13	FLAT
17	LUNA
19	PINHEAD
23	MULTIDISC
25	TETRA
27	TEXTURED
28-29	Which tile where ?
31	GRITSTONE AGGREGATE
35	PEBBLED AGGREGATE
39	ELITE
41	TACTILE CORDUROY
43	TACTILE BLISTER
44-45	FITTINGS
48-55	Important information
56-58	PRODUCT GUIDE (fold out)

WELCOME

The Dorset Woolliscroft Collection is a comprehensive range of quality, hard wearing slip resistant porcelain floor tiles and fittings, all fully vitrified and suitable for internal and external use. The range is associated with a long and established history of tile making which began in 1873 in Poole, Dorset.

THE SAFE CHOICE

The Dorset Woolliscroft slip resistant and safety floor tile ranges were developed with specific areas of usage in mind. Applications include dry and wet areas with heavy foot fall, wheeled traffic areas, and weather exposed areas – in fact, anywhere slip resistant qualities are required. The tiles offer exceptional performance and safety standards for industrial, commercial, leisure and domestic markets and have been thoroughly tested using the most widely recognised test methods currently available.

A SUSTAINABLE SOLUTION

More and more manufacturers, architects and designers are challenged to provide environmentally friendly materials (including flooring) which offer long term and cost effective solutions. This means that life cycle costing of materials is becoming increasingly important. Many studies support the view that ceramic flooring is the most economical and environmentally friendly solution over a lifespan of 50 years.





This image: GRITSTONE AGGREGATE at Milton Keynes Station
(London Midland Trains)
Above: MULTIDISC
Far left: PEBBLED AGGREGATE and STEP TREADS



'Floor surfaces should offer a level of slip resistance that provides a firm foothold and good wheel grip under normal conditions of use'

Design Standards for Accessible Railway Stations
Code of Practice March 2015
www.gov.uk

DORSET
WOOLLISCROFT
The Safest Choice in Floor Tiles

SAFETY FIRST

ACCIDENTS AND INJURIES

The report **Kinds of accident in Great Britain, 2016** includes the most recently available UK Government statistics. Using the Labour Force Survey, it reports on non-fatal injuries by accident, showing an estimated average figure of 119,000 cases of slips, trips or falls for that period. These are self-reported non-fatal workplace injuries. The same report provides information on over-7-day injuries, with slips, trips or falls showing nearly 30% of the total number of injuries. On average, 4.3 million working days were lost due to workplace injuries each year between 2013/14 and 2015/16.

All self-reported non-fatal injuries to worker by accident kind, annual average 2013/14, 2015/16:

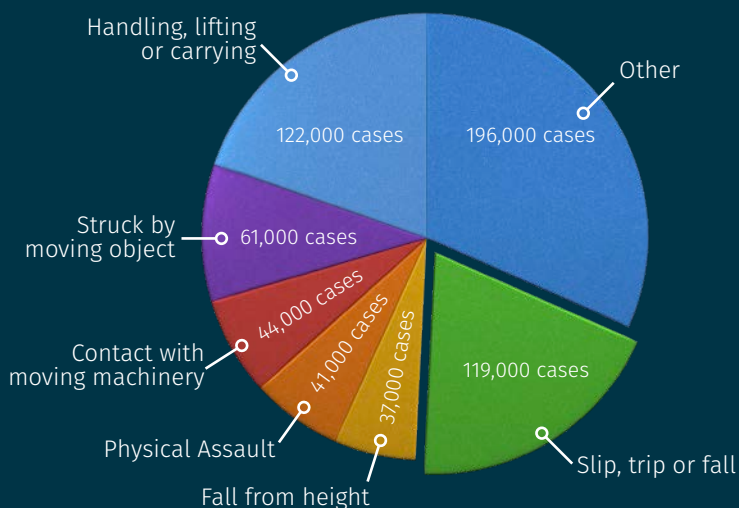

Data: Labour Force Survey
Kinds of accident in Great Britain, 2016
Health and Safety Executive
Contains public sector information
licensed under the Open Government Licence v3.0

Whilst it is obvious that not all of the above injuries were caused by slippery flooring, it is likely to be one of the factors in many slip and fall accidents, not only for employees in their workplace but also for members of the public in any number of commercial, retail, leisure and transport environments. Slip resistant safety flooring has been specifically designed to minimise slips in environments where such an accident could cause harm or serious harm.

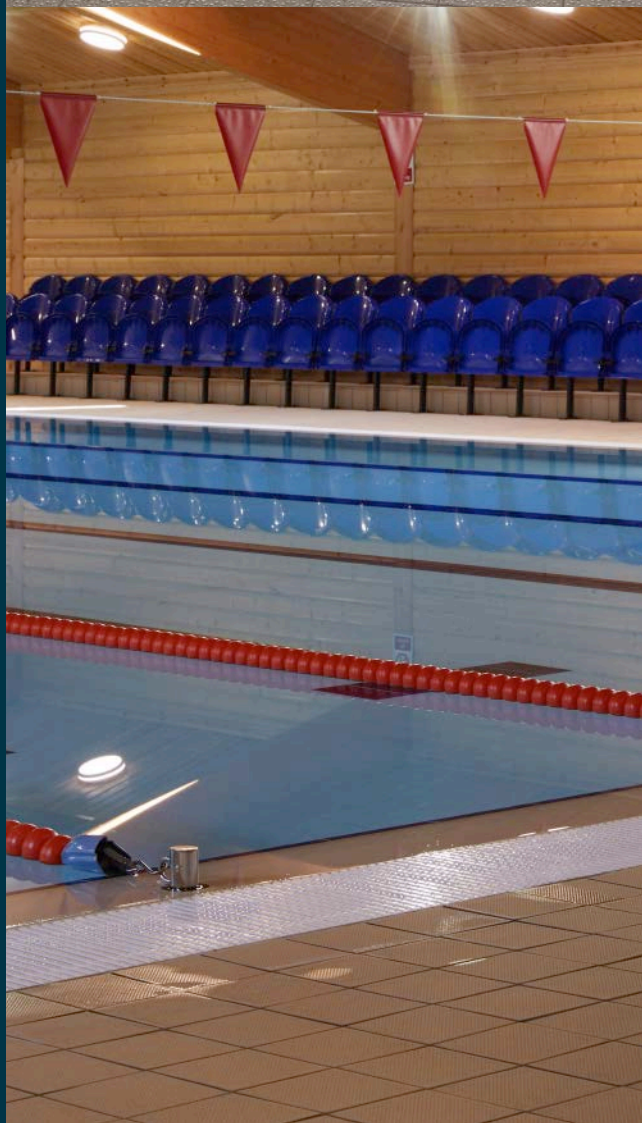



COMPENSATION CULTURE

Whether the UK has a 'compensation culture' or not is still up for debate, however even the most cursory online search for 'compensation for slips and trips' brings up numerous companies and organisations offering No Win No Fee claims for compensation against employers, transport providers, retailers and local councils. An annual survey into global litigation trends found that 16% of types of litigation were for personal injury in the UK in 2016.*

"The 12th annual litigation trends survey reveals an upward trend in virtually all of the metrics relating to litigation and the broader disputes area. Difficult market conditions ... are creating a more litigious environment."

2016 Litigation Trends
Annual Survey
Norton Rose Fulbright (Global law firm)

*2016 Litigation Trends Annual Survey, Norton Rose Fulbright



**DORSET
WOOLLISCROFT**
The Safest Choice in Floor Tiles

This image: PEBBLED AGGREGATE at Fleet Station (London Midland Trains)
Left: PINHEAD at Bethany School, Kent
Above Left: TETRA in a commercial kitchen environment

SAFETY FIRST

FIRE

'Buildings need to be designed to offer an acceptable level of fire safety and minimise the risks from heat and smoke. The primary objective is to reduce to within acceptable limits the potential for death or injury to the occupants of a building and others who may become involved, such as the fire and rescue service, as well as to protect contents and ensure that as much as possible of a building can continue to function after a fire and that it can be repaired.'

www.designingbuildings.co.uk

Technical porcelain tiles (such as Dorset Woolliscroft) installed in buildings and fire exit routes can make an important contribution toward fire safety.

EN14411 Classifies porcelain and ceramic wall and floor tiles with a rating of A1/A1_{FL}. The CEC (European Federation of Ceramic Manufacturers) has carried out experimental analysis of the fire performance of porcelain and ceramic floor and wall tiles.

The conclusions of this study were that **tiles are non-combustible and do not catch fire or give off any smoke**. These findings are critical when considering safety in the built environment.

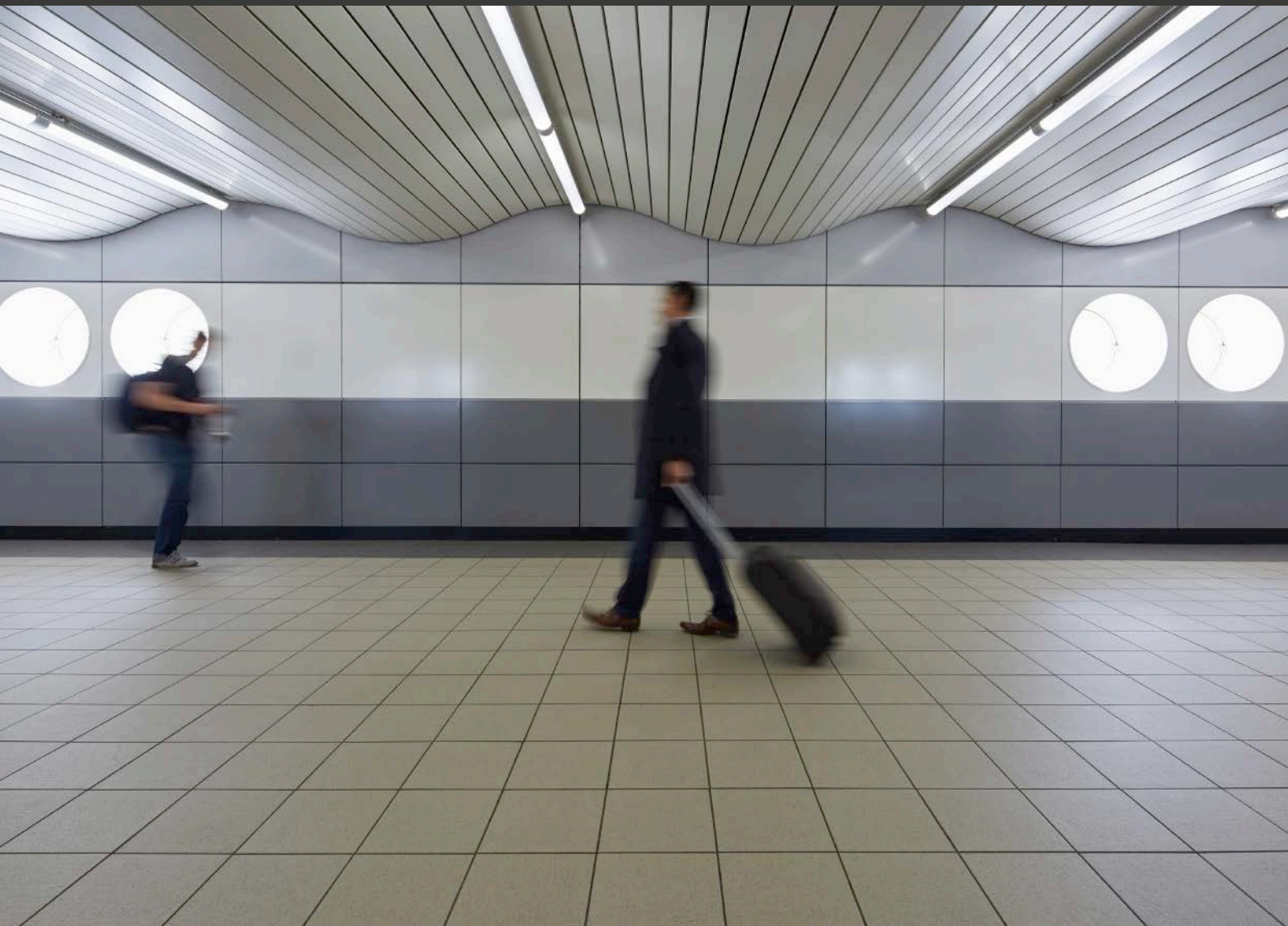

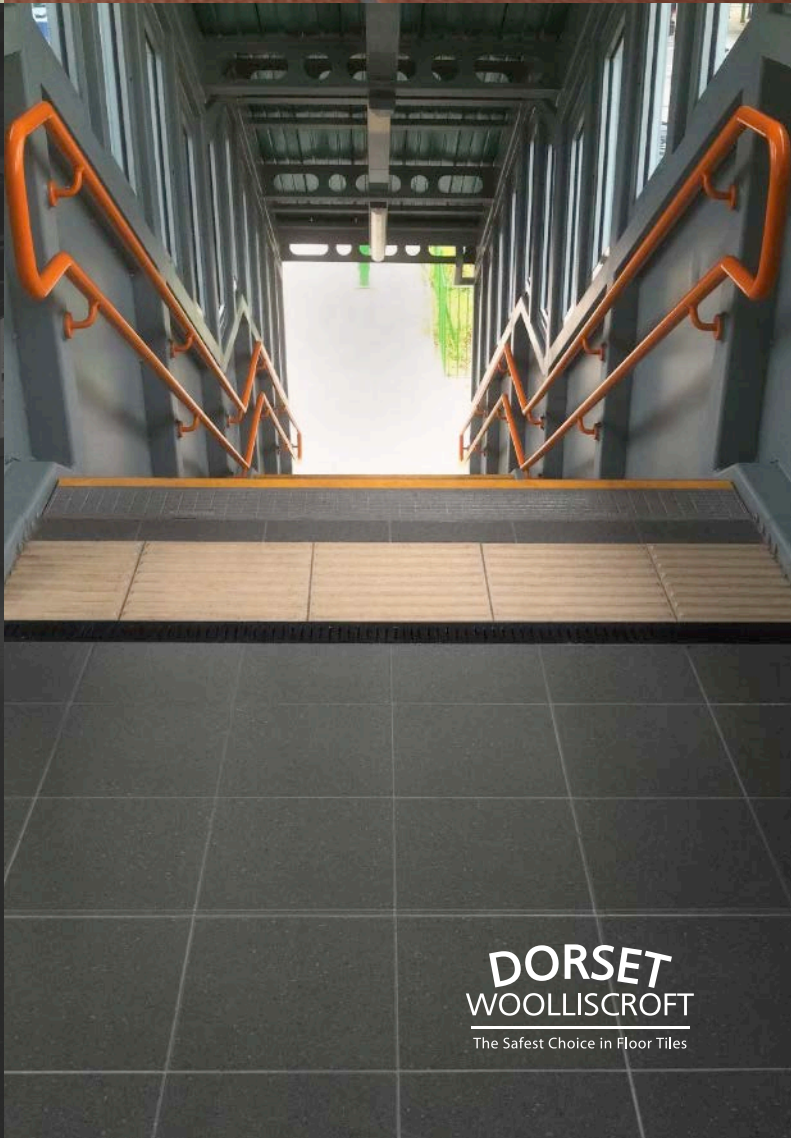
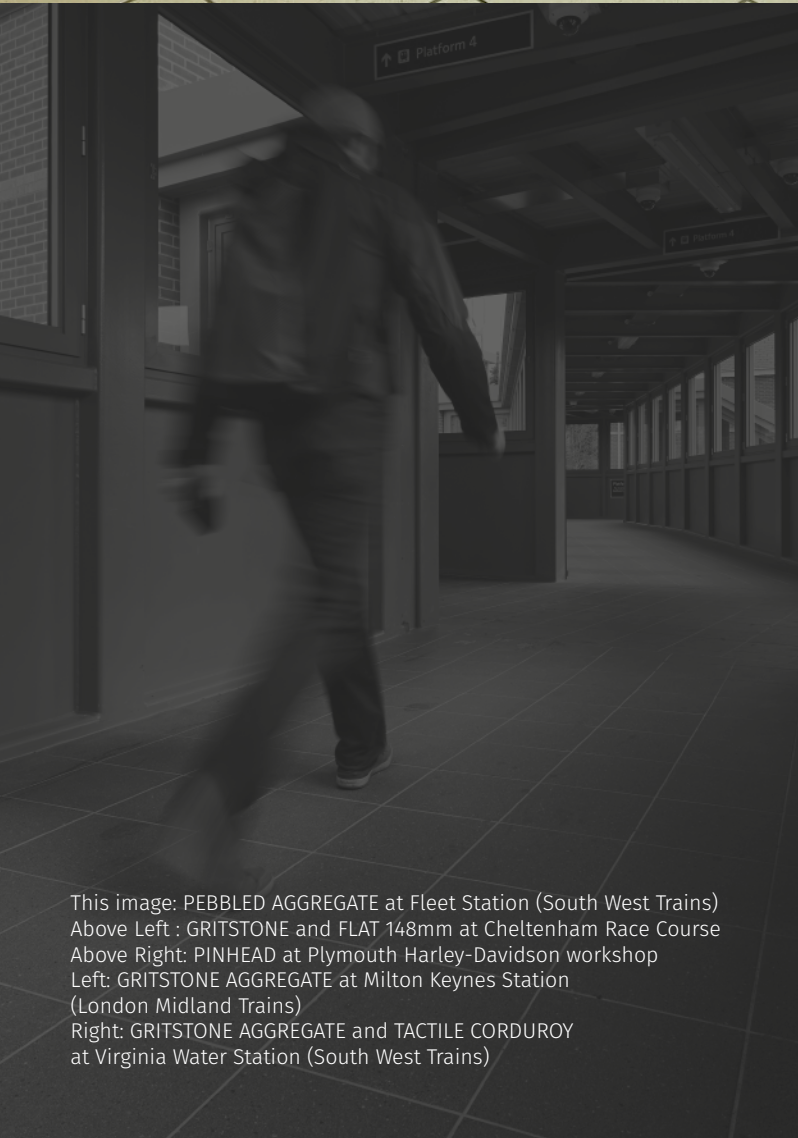
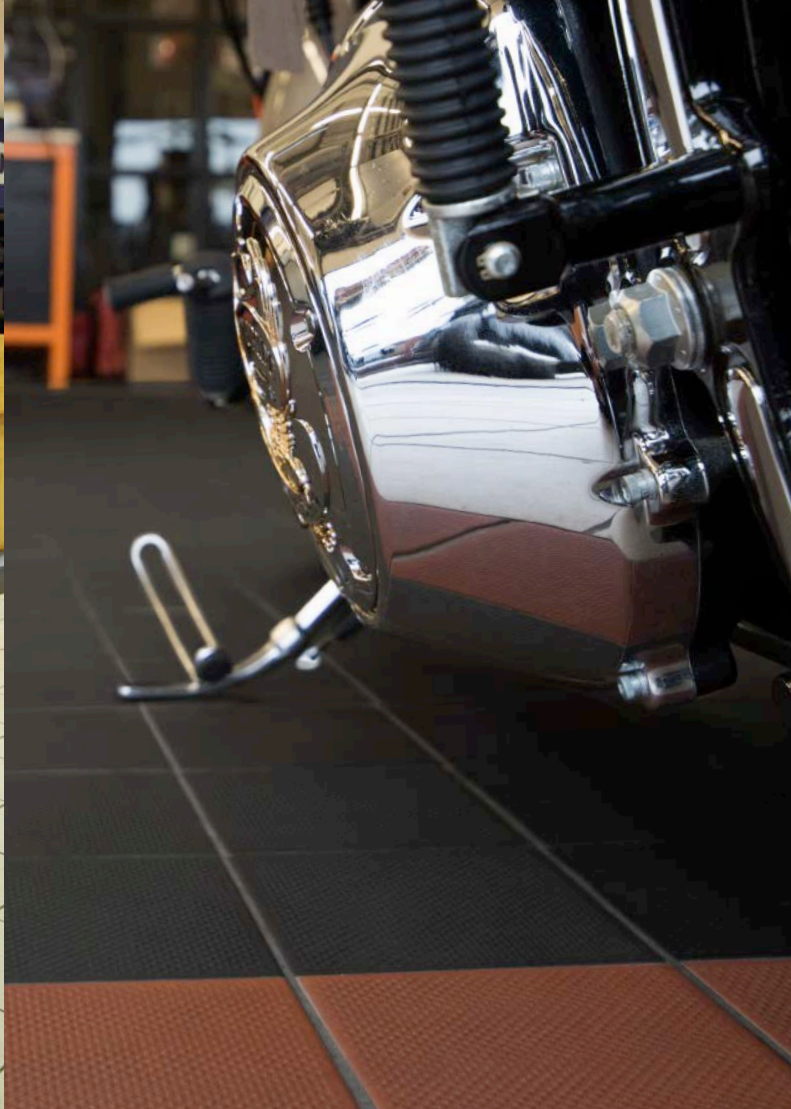

This image: PEBBLED AGGREGATE at Fleet Station (South West Trains)
 Above Left : GRITSTONE and FLAT 148mm at Cheltenham Race Course
 Above Right: PINHEAD at Plymouth Harley-Davidson workshop
 Left: GRITSTONE AGGREGATE at Milton Keynes Station
 (London Midland Trains)
 Right: GRITSTONE AGGREGATE and TACTILE CORDUROY
 at Virginia Water Station (South West Trains)

THE BIGGER PICTURE

SUSTAINING LONG TERM SLIP RESISTANCE

There are more stages in the life cycle of resistant flooring than being selected and specified. Correct installation and ongoing upkeep are key factors to ensuring the tile's original slip resistant properties are maintained.

Testing times

Products that have been specified for particular situations need to be shown to comply with their published characteristics. Before a building is handed over as complete and meeting all building regulations, any slip resistance floor tiles should have been tested (and shown to be tested with documentation) up to four times: independent test results as provided by manufacturer/provider; on delivery; after installation; at point of handover.

Keeping it clean and dry

People rarely slip on floors that are clean and dry. Flooring in an unsatisfactory condition, spillages and poor housekeeping can be responsible for many trip injuries.

It is the building owner's responsibility and duty of care to carry out regular slip resistance testing (recommended annually) and to ensure the correct cleaning regime is in place, which needs to be appropriate for the tile surface and its location – for example cleaning products for general mineral dirt and grime won't be suitable for greasy commercial kitchen situations or swimming pool surrounds. See page 53 for cleaning and maintenance information.

Building regulations recommend that floor surfaces in entrance lobbies in public buildings should help remove external contamination from shoes and wheelchairs to reduce the potential for slipping. Covered canopies and barrier matting, which is absorbent and large enough to ensure the foot is not wet underneath when it reaches the adjacent flooring, help to keep the floor surfaces as clean and dry as possible. This in conjunction with specifying appropriate slip resistant flooring will help ensure that many of the most common risk factors for slips and trips are addressed.

The considered environment

Unfortunately accidents do and will continue to happen. However, we all have a responsibility to ensure that we have considered, removed and addressed all possible risk factors, complied with regulations and can prove compliance.



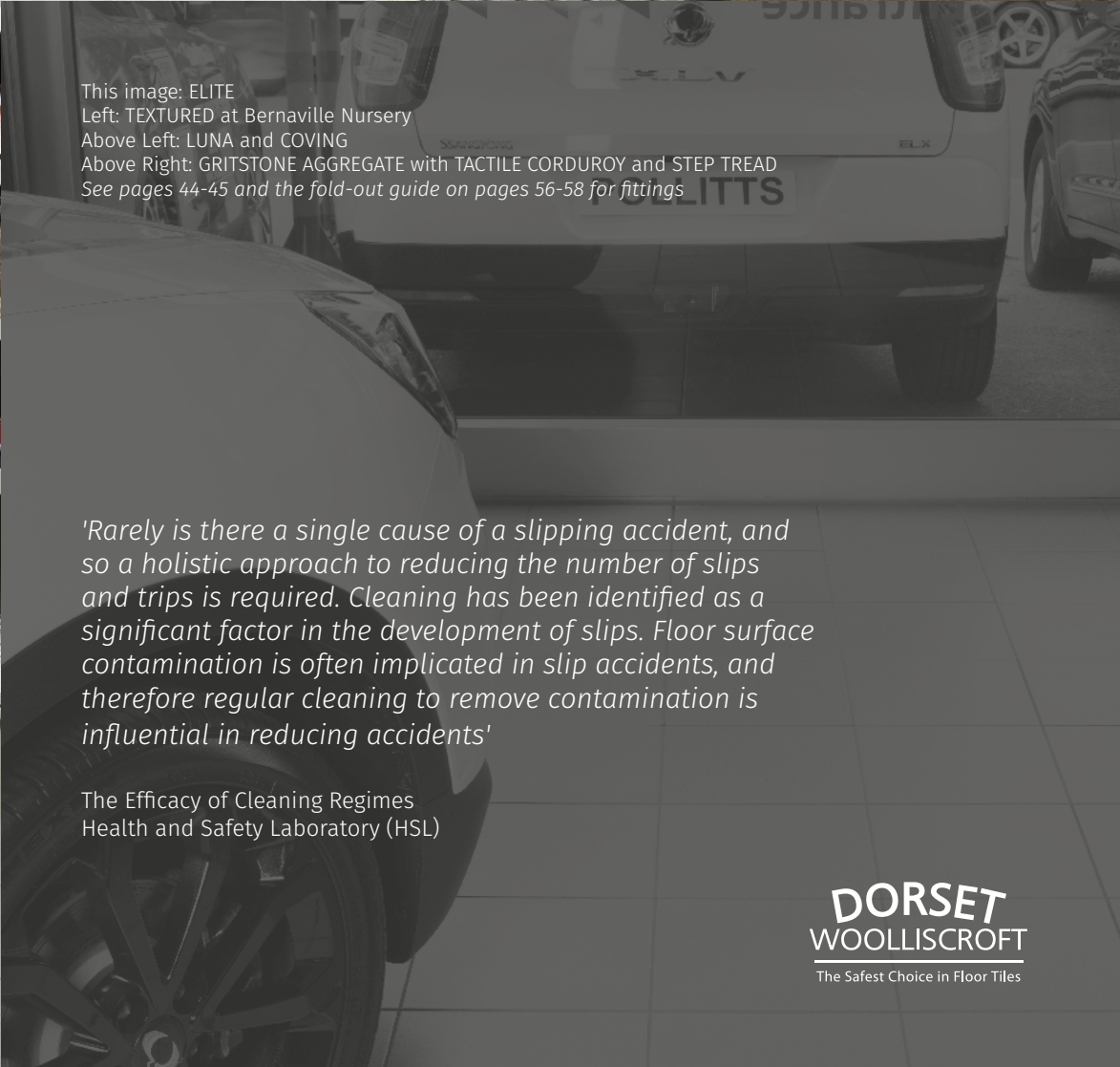

This image: ELITE
 Left: TEXTURED at Bernaville Nursery
 Above Left: LUNA and COVING
 Above Right: GRITSTONE AGGREGATE with TACTILE CORDUROY and STEP TREAD
 See pages 44-45 and the fold-out guide on pages 56-58 for fittings

'Rarely is there a single cause of a slipping accident, and so a holistic approach to reducing the number of slips and trips is required. Cleaning has been identified as a significant factor in the development of slips. Floor surface contamination is often implicated in slip accidents, and therefore regular cleaning to remove contamination is influential in reducing accidents'

The Efficacy of Cleaning Regimes
 Health and Safety Laboratory (HSL)



Coffee & DRINKS

HOT DRINKS



espresso	£2.90
americano	£3.20
macchiato	£3.50
cappuccino	£3.90

try our FRESH award-winning COFFEE

FLAT

DISPLACEMENT VOLUME	SHOD DRY (4S96 dry)	SHOD WET (4S96 wet)	BAREFOOT WET (TRRL 55 wet)	RAMP TEST
n/a	53	37	n/a	R10 A

smooth matt finish

148 x 148 x 9mm • 44pcs / 20kg per m²
 300 x 300 x 9mm • 11pcs / 20kg per m²

A versatile smooth surfaced tile in 2 sizes and 7 colours, which is easy to keep clean.

- ▶ Light catering areas with high traffic such as snack bars, cafés, pubs, bars and restaurants (front of house)
- ▶ Industrial and retail areas such as shops and workshops
- ▶ Residential settings like kitchens and hallways
- ▶ Flat tiles are fully vitrified and are suitable for external use, including floors (shod areas only) or on walls
- ▶ Attractive and practical for external cladding

ⓘ See pages 17, 19, 23, 25 and 26 for tiles more suitable for barefoot wet areas as they need higher specification slip resistant properties



STEEL GREY
 148 x 148 DW-FLSGR1515
 300 x 300 DW-FLSGR3030

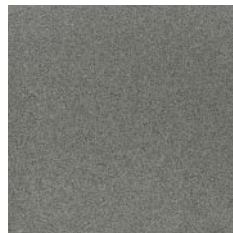

DARK GREY
 148 x 148 DW-FLDGR1515
 300 x 300 DW-FLDGR3030



QUARTZ
 148 x 148 DW-FLQUZ1515
 300 x 300 DW-FLQUZ3030



STONE
 148 x 148 DW-FLSTO1515

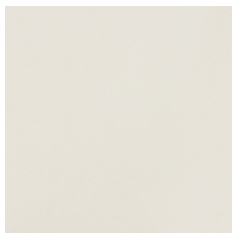

WHITE
 148 x 148 DW-FLWHT1515

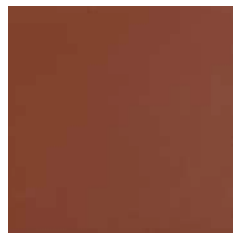

RED
 148 x 148 DW-FLRED1515



BLACK
 148 x 148 DW-FLBLK1515

Reaction to fire - EN14411 Annex ZA:
 Non-combustible
 Wall installation A1 / Floor installation A1_{FL}

FORMATS



148 x 148 x 9mm

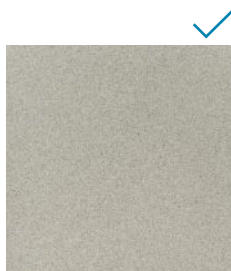

300 x 300 x 9mm



SURFACE DETAIL

WHITE, RED & BLACK are solid colours. STONE, QUARTZ, STEEL GREY & DARK GREY have a flecked effect.

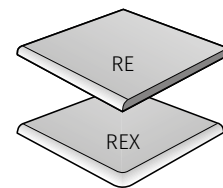

FITTINGS

Round-edge options and co-ordinating fittings available (see page 44)

Left: FLAT STEEL GREY, FLAT DARK GREY 300mm and custom skirting in FLAT DARK GREY (see page 55) shown with Original Style Artworks Brilliant White half tiles



Right: FLAT QUARTZ 148mm (Wall), FLAT BLACK RE and REX (Window Ledge) PEBBLED AGGREGATE SPECKLED DARK GREY (Floor)
Above : FLAT STEEL GREY and DARK GREY 300mm with custom skirting (see page 55) in DARK GREY and Original Style Artworks Brilliant White half tiles

FLAT





LUNA

Left : LUNA WHITE, POOL GRIP WHITE and STEP TREAD BLACK shown with Designworks Tiles Niebla Pool and Spa Mosaics
See pages 44-45 and the fold-out guide on pages 56-58 for fittings
Below: LUNA STEEL GREY 148mm with COVING and CORNER

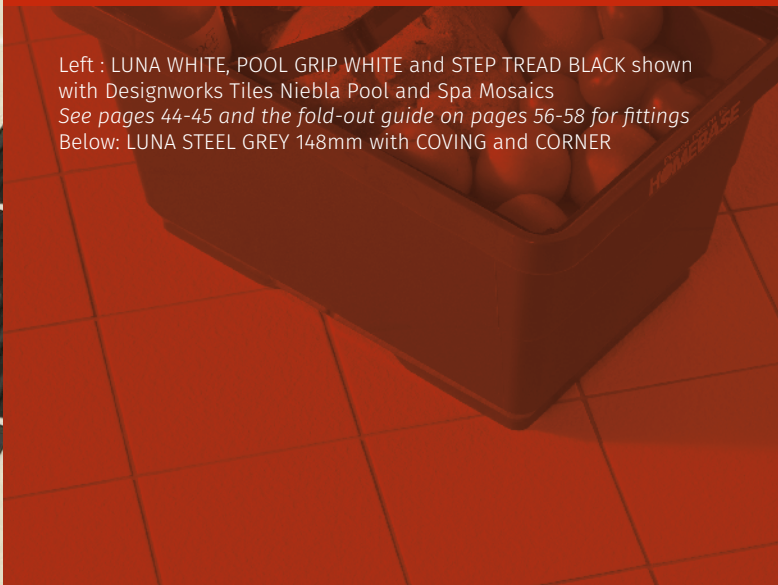



LUNA

DISPLACEMENT VOLUME	SHOD DRY (4S96 dry)	SHOD WET (4S96 wet)	BAREFOOT WET (TRRL 55 wet)	RAMP TEST
n/a	60	54	48	R12 C

stone-effect textured finish

148 x 148 x 9mm • 44pcs / 20kg per m²
 300 x 300 x 9mm • 11pcs / 20kg per m²

The softly textured structure of Luna has excellent slip resistant qualities. It is suitable for shod and barefoot applications in all sorts of dry and wet areas, inside and out. This hard wearing, heavy duty tile is available in 4 colours in 2 sizes, making it the go-to tile for any number of situations. Here are a few applications where Luna can be used with confidence:

- ▶ Heavy foot traffic public areas such as shops and retail units
- ▶ Commercial installations including areas with ramps or sloping areas
- ▶ Spas, sports clubs, leisure centres and swimming pools for pool surrounds, changing areas and shower floors
- ▶ Industrial areas such as workshops and studios
- ▶ Catering environments including food preparation areas

❗ See pages 19, 23, 25 and 27 for more tiles suitable for wet areas (shod and barefoot)



STEEL GREY
 148 x 148 DW-LUSGR1515
 300 x 300 DW-LUSGR3030



DARK GREY
 148 x 148 DW-LUDGR1515
 300 x 300 DW-LUDGR3030

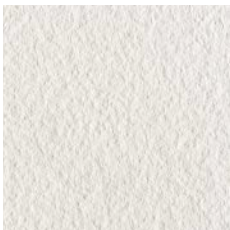

WHITE
 148 x 148 DW-LUWHT1515
 300 x 300 DW-LUWHT3030



QUARTZ
 148 x 148 DW-LUQUZ1515
 300 x 300 DW-LUQUZ3030

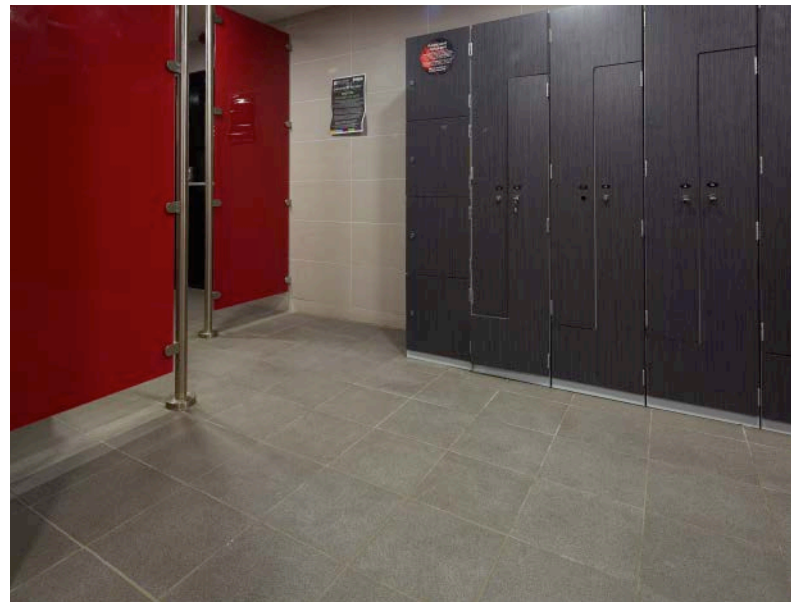

FORMATS

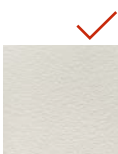

148 x 148 x 9mm

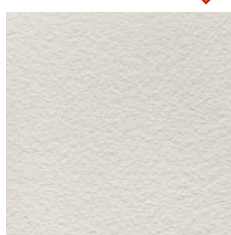

300 x 300 x 9mm



SURFACE DETAIL

Reaction to fire - EN14411 Annex ZA:
 Non-combustible
 Wall installation A1 / Floor installation A1_{FL}

Left: LUNA STEEL GREY 148mm with COVING STEEL GREY / Above: LUNA DARK GREY 300mm at Junction Sports Centre
 See pages 44-45 and the fold-out guide on pages 56-58 for fittings



PINHEAD

DISPLACEMENT VOLUME	SHOD DRY (4S96 dry)	SHOD WET (4S96 wet)	BAREFOOT WET (TRRL 55 wet)	RAMP TEST
V4	62	54	48	R11C

high volume pimpled finish

148 x 148 x 9mm • 44pcs / 20kg per m²

Another general purpose slip resistant tile suitable for wet and dry areas, shod and barefoot, inside and out. The pinhead profile has good volume displacement properties (V4) and this attractive profile is also comfortable for bare feet making it a great choice for spa/leisure environments. Other applications include:

- ▶ Most internal and external applications, wet and dry, included ramped areas
- ▶ Light industrial areas
- ▶ Showrooms, waiting and reception areas
- ▶ Hospitality establishments, both front of house and food preparation areas
- ▶ Commercial and retail
- ▶ Dry-wet spaces such as swimming pool changing rooms, showers
- ▶ Public toilets and washrooms

📌 See pages 17, 23, 25 and 27 for more tiles suitable for wet areas (shod and barefoot)



STEEL GREY
148 x 148 DW-PHSGR1515



DARK GREY
148 x 148 DW-PHDGR1515



QUARTZ
148 x 148 DW-PHQZ1515



STONE
148 x 148 DW-PHSTO1515



WHITE
148 x 148 DW-PHWHT1515

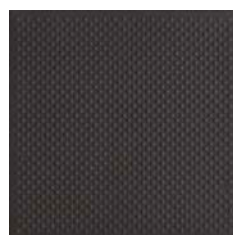

BLACK
148 x 148 DW-PHBLK1515



RED
148 x 148 DW-PHRED1515

FORMAT



148 x 148 x 9mm

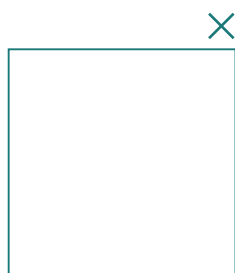

300 x 300 x 9mm



SURFACE DETAIL

Reaction to fire - EN14411 Annex ZA:
Non-combustible
Wall installation A1 / Floor installation A1_{FL}

Left: PINHEAD STONE (floor) with COVING STONE and FLAT WHITE 148mm (Wall)
See pages 44-45 and the fold-out guide on pages 56-58 for fittings



PINHEAD

Above: PINHEAD QUARTZ at Cheltenham Race Course
Right: PINHEAD WHITE

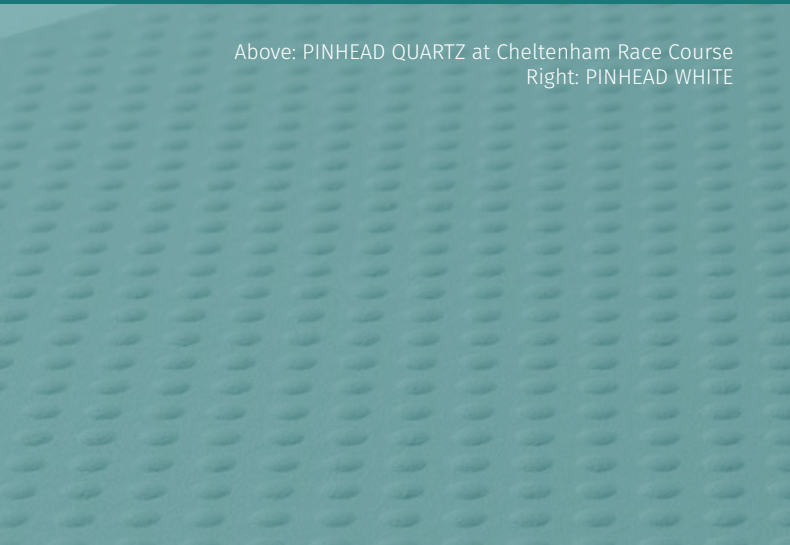



Left: MULTIDISC DARK GREY
Below : MULTIDISC QUARTZ



MULTIDISC





MULTIDISC

DISPLACEMENT VOLUME	SHOD DRY (4S96 dry)	SHOD WET (4S96 wet)	BAREFOOT WET (TRRL 55 wet)	RAMP TEST
V6	70	58	44	R12 C

softly contoured spot finish

148 x 148 x 9mm • 44pcs / 20kg per m²

As well as being good to look at, Multidisc's round raised surface structure is also comfortable underfoot even with bare feet. The pendulum tests to assess slip resistant in both wet and dry conditions show exceptional low levels of slip potential (70 dry/58 wet). Its V6 volume displacement results show its suitability for commercial kitchens and food preparation areas, and it is still easy to keep clean. Suitable for:

- ▶ High traffic areas in both dry and wet conditions, internal and external
- ▶ Barefoot wet areas like changing rooms, showers, toilets in leisure complexes and swimming pools
- ▶ Commercial hospitality settings like fast food units

❗ See pages 17, 19, 25 and 27 for more tiles suitable for wet areas (shod and barefoot)

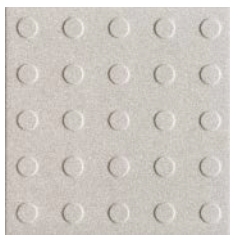

STEEL GREY
148 x 148 DW-MDSGR1515

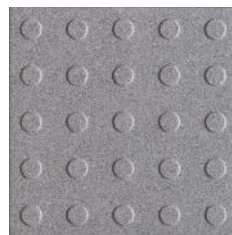

DARK GREY
148 x 148 DW-MDDGR1515



WHITE
148 x 148 DW-MDWHT1515



QUARTZ
148 x 148 DW-MDQUZ1515



FORMAT



148 x 148 x 9mm

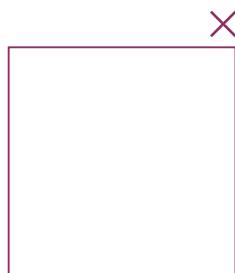

300 x 300 x 9mm



SURFACE DETAIL

Reaction to fire - EN14411 Annex ZA:
Non-combustible
Wall installation A1 / Floor installation A1_{FL}



TETRA

DISPLACEMENT VOLUME	SHOD DRY (4S96 dry)	SHOD WET (4S96 wet)	BAREFOOT WET (TRRL 55 wet)	RAMP TEST
V4	65	55	42	R11 C

polygon structured finish

148 x 148 x 9mm • 44pcs / 20kg per m²
 300 x 300 x 9mm • 11pcs / 20kg per m²

The pyramid shapes on the surface profile means that Tetra has excellent slip resistant qualities for all areas of bare foot and shod foot traffic. It has good volume displacement properties (V4) as the profile has been designed to pierce surface debris – make it a great choice for preparation areas where heavy soiling is likely. Also use it for:

- ▶ Changing rooms and shower areas in swimming pools and health spas
- ▶ Retail and light industrial unit
- ▶ Commercial kitchens and food preparation areas
- ▶ External walkways

📌 See pages 17, 19, 23 and 27 for more tiles suitable for wet areas (shod and barefoot)



STEEL GREY
 148 x 148 DW-TESGR1515
 300 x 300 DW-TESGR3030

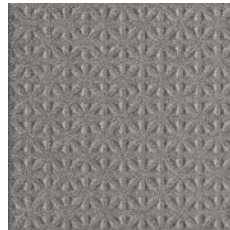

DARK GREY
 148 x 148 DW-TEDGR1515
 300 x 300 DW-TEDGR3030



QUARTZ
 148 x 148 DW-TEQUZ1515
 300 x 300 DW-TEQUZ3030



WHITE
 148 x 148 DW-TEWHT1515



FORMATS



148 x 148 x 9mm

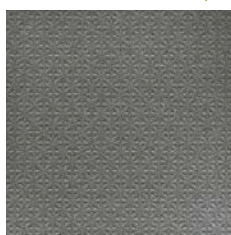

300 x 300 x 9mm



SURFACE DETAIL

Reaction to fire - EN14411 Annex ZA:
 Non-combustible
 Wall installation A1 / Floor installation A1_{FL}

Left and above: TETRA DARK GREY 148mm



Made in Devon

Grafted Vines
£2.95 each
3 for £7.00

Grafted Tomatoes & Peppers
£3.99

SHAKY BRIDGE
SHAKY BRIDGE
SHAKY BRIDGE

TEXTURED

DISPLACEMENT VOLUME	SHOD DRY (4S96 dry)	SHOD WET (4S96 wet)	BAREFOOT WET (TRRL 55 wet)	RAMP TEST
n/a	56	47	47	R11 B

lightly rippled finish

300 x 300 x 9mm • 11pcs / 20kg per m²

A multipurpose 300 x 300mm tile in 3 contemporary and co-ordinating colours that has good slip resistant qualities. Its subtle texture is easy to maintain and keep clean and ensures its suitability for the following locations and more:

- ▶ Retail – inside and outside shops, garden centres, on walkways and concourses
- ▶ Transport hubs – ticket halls, fast food outlets, public toilets, walkways and entrances
- ▶ Catering – front of house and food preparation areas
- ▶ Manufacturing – workshops, warehouses, locker rooms
- ▶ Leisure – reception areas, corridors, changing rooms, toilets and showers
- ▶ Network Rail approved

ⓘ See pages 17, 19, and 23 for more tiles suitable for wet areas (shod and barefoot)



STEEL GREY
300 x 300 DW-TXSGR3030

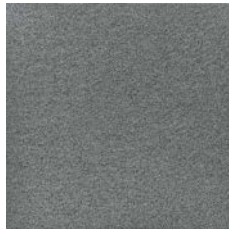

DARK GREY
300 x 300 DW-TXDGR3030



QUARTZ
300 x 300 DW-TXQUZ3030



FORMAT

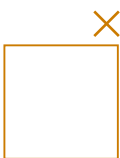

148 x 148 x 9mm

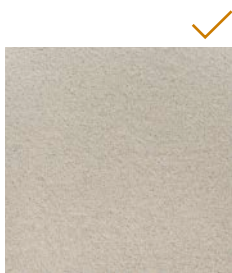

300 x 300 x 9mm



SURFACE DETAIL

Reaction to fire - EN14411 Annex ZA:
Non-combustible
Wall installation A1 / Floor installation A1_{FL}

Shower Floor



MULTIDISC see page 23

Shower Drainage



CHANNELS see page 45

Shower Wall



COVING see page 44

Locker / Changing Areas



PINHEAD see page 19

Food Preparation



TETRA see page 23

Loading Bay /
Wheel Traffic Areas



ELITE see page 39

Station Platform



GRITSTONE AGG. see page 31

Station Platform



TACTILE BLISTER see page 43

Station Ticket Hall



PEBBLED AGG. see page 35

WHICH TILE WHERE?

This diagram represents a typical modern retail and leisure complex which includes health, recreation, shopping and dining areas. Also represented are the associated service areas such as food preparation, toilet facilities, retail units, goods handling, parking and transportation zones.

For each area we have indicated which Dorset Woolliscroft product, in general, provides the optimum level of performance.

<p>Poolside Areas</p>  <p>LUNA see page 17</p>	<p>Pool Edge</p>  <p>POOL GRIP see page 44</p>
---	---

Main Concourse / Retail Units
Food Service Areas



FLAT see page 13

Toilets



TEXTURED see page 27

External Wall Cladding



FLAT see page 13

Steps / Access Ramp



PEBBLED AGG. see page 35

Step / Ramp Approaches



TACTILE CORDUROY see page 41

Step Edges



STEP TREAD see page 45

In addition to this guide please use the technical charts on pages 56-58 to help you choose the perfect tile for your needs.

GRITSTONE AGGREGATE

DISPLACEMENT VOLUME	SHOD DRY (4S96 dry)	SHOD WET (4S96 wet)	BAREFOOT WET (TRRL 55 wet)	RAMP TEST
n/a	58	50	n/a*	R11 (shod only)

heavy duty gritted finish

* not suitable for barefoot use

300 x 300 x 9mm • 11pcs / 24kg per m²

A hard wearing tile with aluminium oxide particles embedded throughout for sustainable slip resistance. Like Pebbled Aggregate (see page 35), it is a practical solution for:

- ▶ Areas requiring a heavy duty surface
- ▶ High traffic areas such as public transport locations
- ▶ Wheeled trolley traffic areas and access ramps
- ▶ Food preparation and manufacturing areas
- ▶ External areas requiring slip resistance in all types of weather conditions
- ▶ Network Rail approved



STEEL GREY
300 x 300 DW-GASGR3030



DARK GREY
300 x 300 DW-GADGR3030

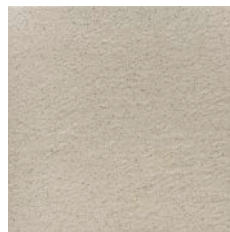

QUARTZ
300 x 300 DW-GAQUZ3030

FORMAT

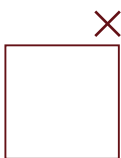

148 x 148 x 9mm



300 x 300 x 9mm



SURFACE DETAIL

Reaction to fire - EN14411 Annex ZA:
Non-combustible
Wall installation A1 / Floor installation A1_{FL}

Left: DARK GREY at Wokingham Station (South West Trains) / Above: QUARTZ

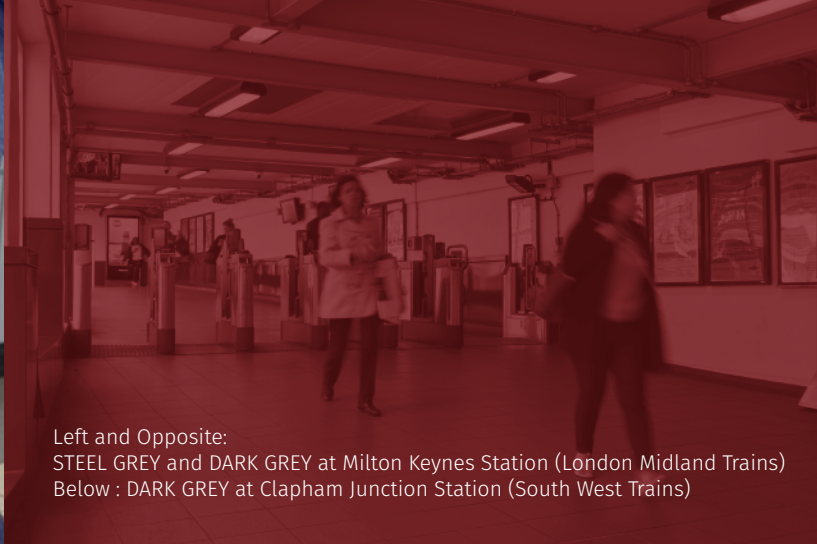

Left and Opposite:
STEEL GREY and DARK GREY at Milton Keynes Station (London Midland Trains)
Below : DARK GREY at Clapham Junction Station (South West Trains)

GRITSTONE AGGREGATE

'Keeping people safe on the railway is at the heart of everything we do. As the operator of the railway, we're responsible for keeping passengers and those who live or work near the railway safe. We take this responsibility very seriously' Network Rail







PEBBLED AGG | 34

PEBBLED AGGREGATE

DISPLACEMENT VOLUME	SHOD DRY (4S96 dry)	SHOD WET (4S96 wet)	BAREFOOT WET (TRRL 55 wet)	RAMP TEST
n/a	60	48	n/a*	R11 (shod only)

heavy duty speckled finish

* not suitable for barefoot use

300 x 300 x 11mm • 11pcs / 24kg per m²

This stylish and super hard wearing tile has aggregate running throughout the whole body. With a thickness of 11mm as well, it means Pebbled Aggregate will deliver on performance, have excellent longevity and anti-slip properties wherever it is installed. With Network Rail approval Pebbled Aggregate is recommended for these transport environments and other areas:

- ▶ High traffic public areas
- ▶ Station concourses, platforms, stairs and footbridges
- ▶ Ramped areas
- ▶ Ticket halls, entrances
- ▶ Toilets
- ▶ Food preparation and serving areas
- ▶ Retail units
- ▶ Pubs, bars, restaurants and other food service areas
- ▶ Network Rail approved



SPECKLED STEEL GREY
300 x 300 DW-PASSG3030

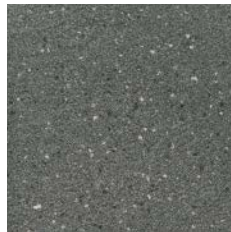

SPECKLED DARK GREY
300 x 300 DW-PASDG3030

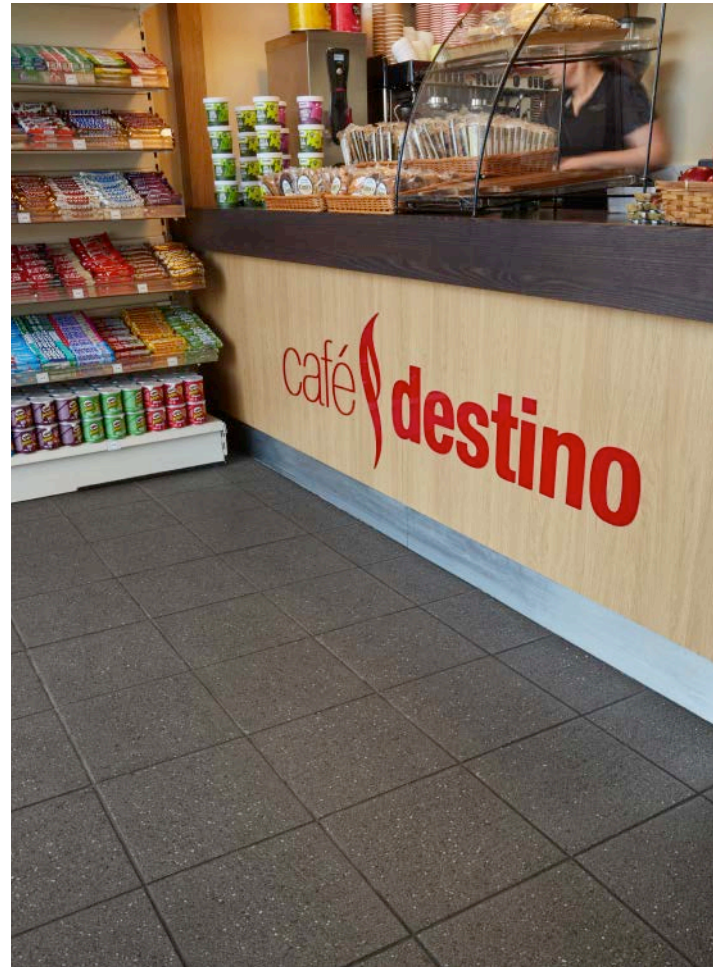

Reaction to fire - EN14411 Annex ZA:
Non-combustible
Wall installation A1 / Floor installation A1_{FL}

FORMAT

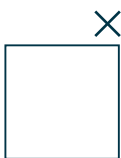

148 x 148 x 11mm

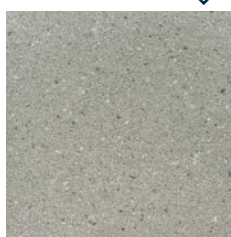

300 x 300 x 11mm



SURFACE DETAIL



Left: SPECKLED STEEL GREY and SPECKLED DARK GREY with STEP EDGE and TACTILE CORDUROY (see page 41)
Above: SPECKLED DARK GREY in a retail area at Fleet Railway Station
See pages 44-45 and the fold-out guide on pages 56-58 for fittings

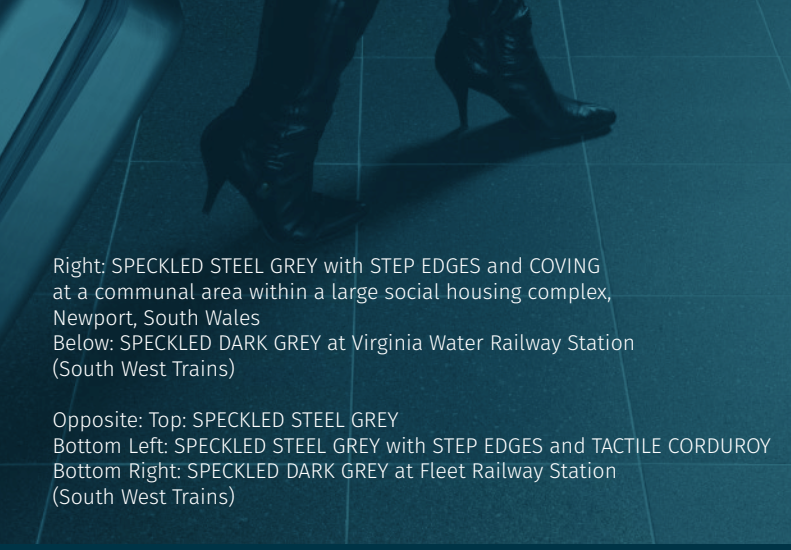

Right: SPECKLED STEEL GREY with STEP EDGES and COVING
at a communal area within a large social housing complex,
Newport, South Wales
Below: SPECKLED DARK GREY at Virginia Water Railway Station
(South West Trains)

Opposite: Top: SPECKLED STEEL GREY
Bottom Left: SPECKLED STEEL GREY with STEP EDGES and TACTILE CORDUROY
Bottom Right: SPECKLED DARK GREY at Fleet Railway Station
(South West Trains)

PEBBLED AGGREGATE

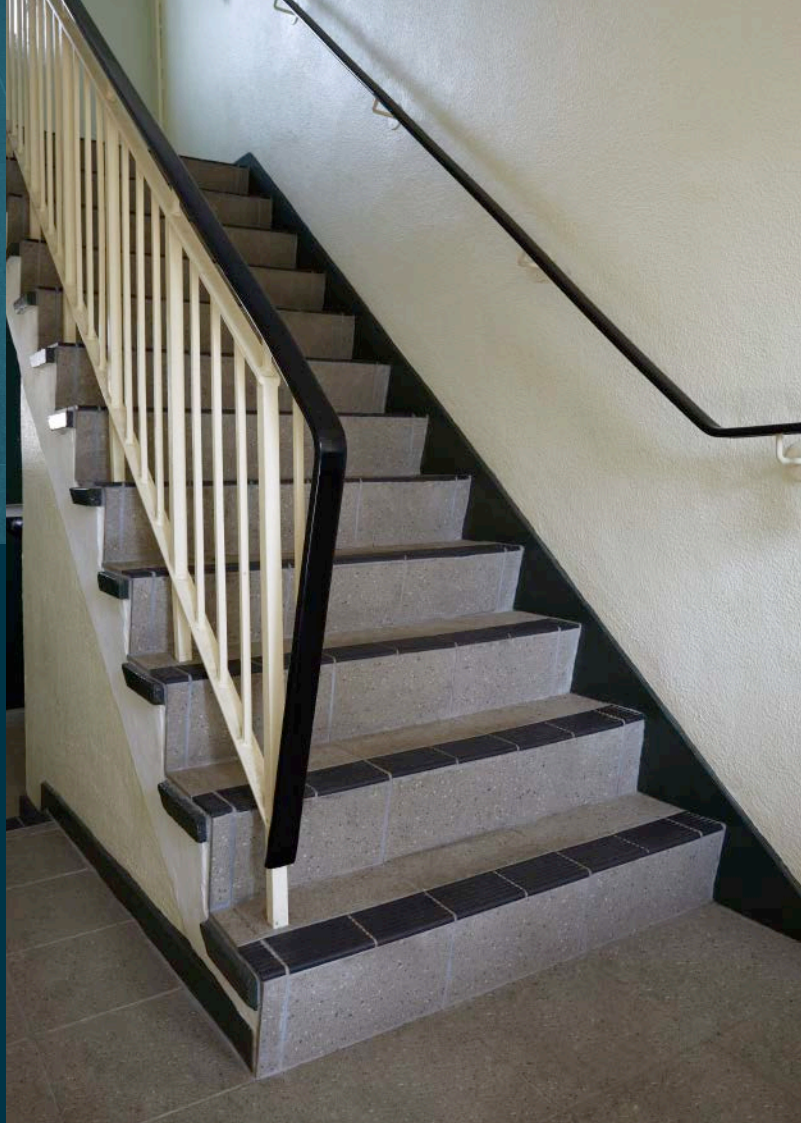

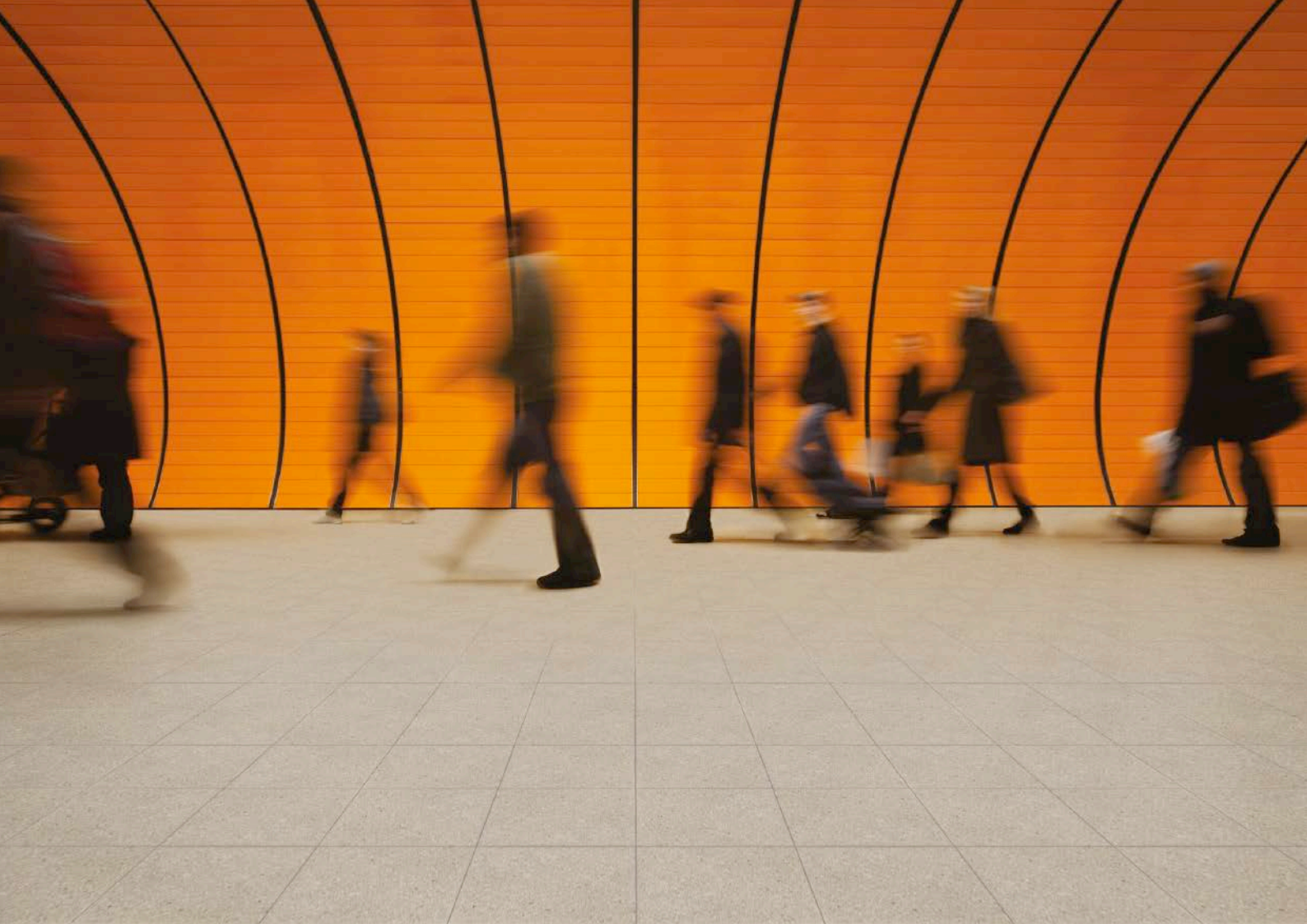

'The surface materials used for a ramp should be chosen to be as easy to maintain and as slip-resistant as possible, especially in wet weather or where spillage occurs'

*Design Standards for Accessible Railway Stations
Code of Practice November 2011
www.gov.uk*





NO SMOKING
Please do not smoke in this area
Smoking is prohibited in this area

TIVOLI ILOVIT

XEV

SSANGYONG

POLLITTS

XLX

SSANGYONG

ELITE

DISPLACEMENT VOLUME	SHOD DRY (4S96 dry)	SHOD WET (4S96 wet)	BAREFOOT WET (TRRL 55 wet)	RAMP TEST
n/a	56	35	n/a*	R10 (shod only)

extra heavy duty matt finish

* not suitable for barefoot use

300 x 300 x 12mm • 11pcs / 26kg per m²

At 12mm this is the thickest, strongest tile from Dorset Woolliscroft. It will withstand substantial weights, as the thicker the tile the greater the load distribution. It provides a hard and solid slip resistant surface for many different and challenging environments, from retail to transport, and more:

- ▶ Exceptional strength to withstand impact and provide a solid stable surface
- ▶ Excellent surface hardness and chemical resistance
- ▶ Stain resistant and easy to maintain and clean
- ▶ Cushion edged for narrow joints to withstand heavy point of loading and wheeled trolley traffic
- ▶ Recommended for food and beverage industry, restaurants, pubs, bars and other food service areas (front of house)
- ▶ Suitable for the automotive industry in both showrooms and workshops
- ▶ Public transport environments such as ticket halls, internal stairs and toilets

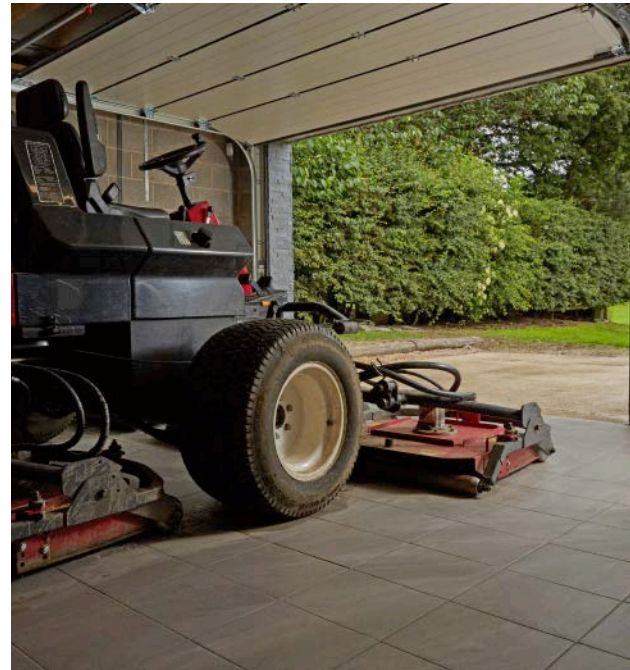

LIGHT GREY
300 x 300 DW-ELLGR3030



CHARCOAL
300 x 300 DW-ELCHC3030

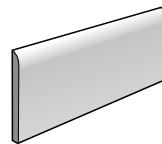

SKIRTING
300 x 100
CHARCOAL DW-ELCH3010
LIGHT GREY DW-ELLGR3010

FORMAT

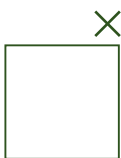

148 x 148 x 12mm

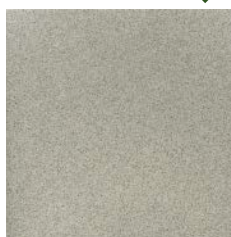

300 x 300 x 12mm

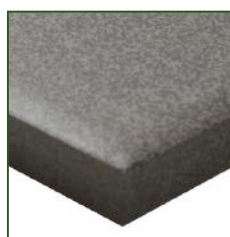

SURFACE DETAIL

Reaction to fire - EN14411 Annex ZA:
Non-combustible
Wall installation A1 / Floor installation A1_{FL}

Left and Above: LIGHT GREY in use in heavy commercial settings



TACTILE | 40

See guide on pages 56-58 for SATRA Dynamic Coefficient of Friction Test Results

DISPLACEMENT VOLUME	SHOD DRY (4S96 dry)	SHOD WET (4S96 wet)	BAREFOOT WET (TRRL 55 wet)	RAMP TEST
n/a	62	57	n/a	n/a

TACTILE CORDUROY

high-profile tactile finish

400 x 400 x 12.5mm • 6.2pcs / 27.9kg per m²

Like Tactile Blister (see page 43), Tactile Corduroy contains porcelain aggregate throughout the tile body, for hard wearing and sustainable qualities. The Corduroy profile is designed to warn visually impaired people of the presence of specific hazards and implies 'proceed with caution'. The two shades are contrasting colours which meet current building regulations for LRV contrasting variance. Features include:

- ▶ Thickness of 12.5mm for very heavy traffic areas
- ▶ Meets the requirements of the Joint Mobility Unit of the RNIB, DETR and the CAE
- ▶ Exceptional performance and safety standards
- ▶ 'Blister' option also available (see page 43)
- ▶ Network Rail approved
- ▶ No colour fading in UV light

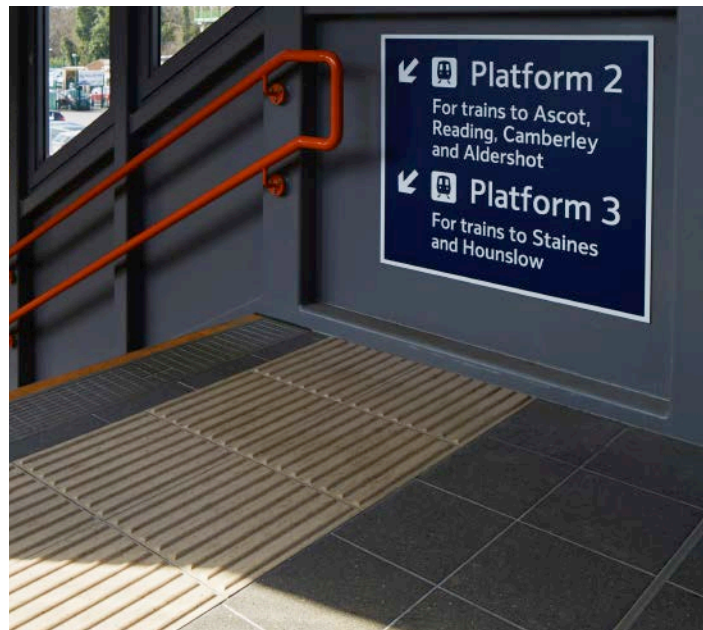

ANTHRACITE CORDUROY
400 x 400 DW-TCANT4040



SAND CORDUROY
400 x 400 DW-TCSND4040

Reaction to fire - EN14411 Annex ZA:
Non-combustible
Floor installation A1_{FL}

Tested to
London Underground Ltd
TMI44:1999 Modified Standard

"When moving around the pedestrian environment, visually impaired people will actively seek and make use of tactile information underfoot. It is therefore important that textures warning of potential hazards ... are rigorous enough to be detectable by most people but without constituting a trip hazard or causing extreme discomfort."

Guidance on the use of tactile paving surfaces
Department of Transport

Left: ANTHRACITE with GRITSTONE STEEL GREY and STEP EDGE BLACK (see pages 44,45 and 58 for fittings)
Above: SAND with PEBBLED AGGREGATE DARK GREY (see page 35) at Virginia Water Station (South West Trains)

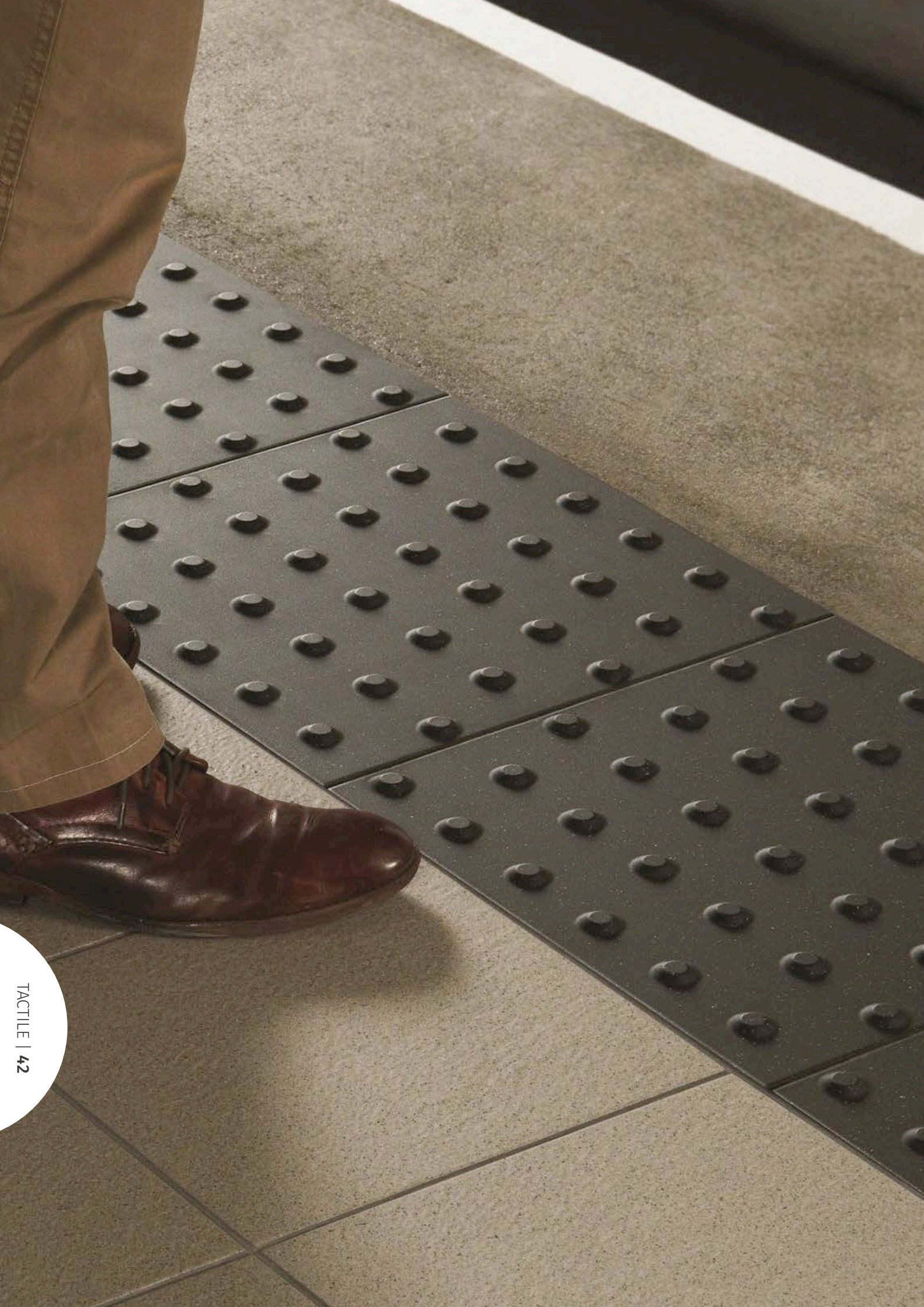

DISPLACEMENT VOLUME	SHOD DRY (4S96 dry)	SHOD WET (4S96 wet)	BAREFOOT WET (TRRL 55 wet)	RAMP TEST
n/a	77	66	n/a	n/a

high-profile tactile finish

TACTILE BLISTER

400 x 400 x 12.5mm • 6.2pcs / 27.9kg per m²

Like Tactile Corduroy (see page 41) this hard wearing Tactile contains porcelain aggregate throughout. The Blister profile is designed to warn the visually impaired of the edge of all off-street platforms and pavements near crossings. It is also used for heavy rail platforms.

- ▶ Thickness of 12.5mm means it is very strong and rigid for very heavy traffic areas
- ▶ Meets the requirements of the Joint Mobility Unit of the RNIB, DETR and the CAE
- ▶ Profile conforms to British and European standards
- ▶ Exceptional performance and safety standards
- ▶ 'Corduroy' option also available (see page 41)
- ▶ Network Rail approved
- ▶ No colour fading in UV light



ANTHRACITE BLISTER
400 x 400 DW-TBANT4040



SAND BLISTER
400 x 400 DW-TBSND4040

Tested to
London Underground Ltd
TM144:1999 Modified Standard

Reaction to fire - EN14411 Annex ZA:
Non-combustible
Floor installation A1_{FL}

Left and above: ANTHRACITE BLISTER with GRITSTONE QUARTZ

FITTINGS

Created to complement the Dorset Woolliscroft range. Fittings are key to achieving the perfect finish and getting optimum levels of performance from the installation.

ROUND EDGE TILES



REX (Round Edge External)
148 x 148 x 9mm



RE (Round Edge)
148 x 148 x 9mm

Use RE vertically as a skirting piece

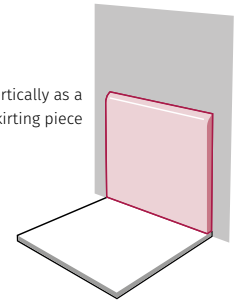

- ▶ RE Provides safe, ergonomic edges to shelves, window ledges and recesses
- ▶ REX provides smooth finish on surface corners
- ▶ RE can be used vertically as a skirting tile or as a finishing piece on any installation
- ▶ Available in 7 colours

COVING



COVING
148 x 109 x 9mm



EXT. ANGLE
109 x 30 x 9mm



INT. ANGLE
109 x 30 x 9mm

Flush mount for a smooth wall to floor transition

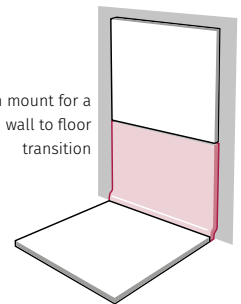

Surface mount

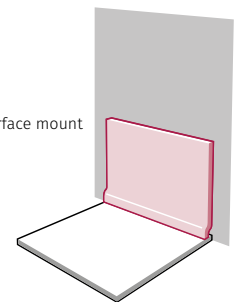

- ▶ Provides a smart, fully integrated finish
- ▶ Reduces 'dirt traps' in corners and at wall and floor transitions
- ▶ Hygienic and easy to clean
- ▶ Protects walls from footwear scuffs and potential damage from cleaning equipment
- ▶ Can be surface mounted over floor tiles or flush mounted with wall and floor tiles
- ▶ Available in 7 colours

POOL GRIP 148 x 109 x 9mm

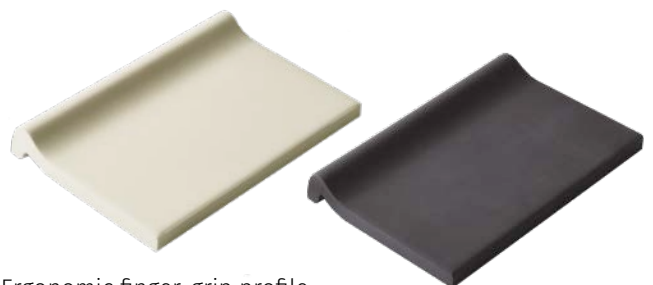

- ▶ Ergonomic finger-grip profile
- ▶ Available in BLACK and WHITE for maximum visual contrast

STEP TREAD



STEP TREAD
148 x 100 x 12mm

STEP TREAD CORNER
100 x 100 x 12mm

- ▶ 12mm thick for extra durability
- ▶ Grooved profile for grip
- ▶ Bullnosed edge for comfort and safety
- ▶ Provides visual warning of surface edges
- ▶ Suitable for use as a pool grip
- ▶ Available in WHITE, BLACK, DARK GREY and QUARTZ – use in contrast to floor tiles for high visibility

CHANNELS



STRAIGHT
148 x 148 x 12mm



CORNER
148 x 148 x 12mm

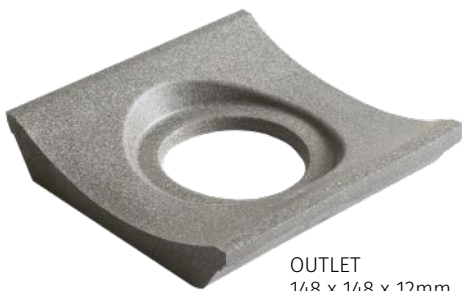

OUTLET
148 x 148 x 12mm
(see page 57 for detailed dimensions)



STOP
148 x 148 x 12mm

- ▶ Ergonomic 'foot friendly' form factor
- ▶ Effective drainage
- ▶ Available in DARK GREY, BLACK and QUARTZ – to blend or contrast with the main floor tile

See the fold-out guide on page 56-58
for specifications and product codes

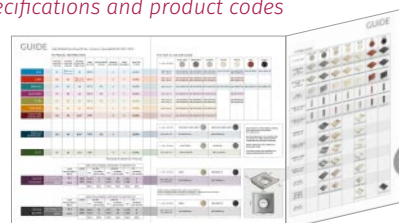
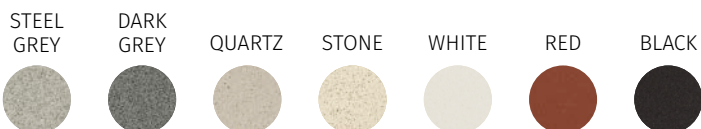

FITTINGS

Right: STEP TREADS

Below Left: REX and RE used as window sill

Below Right: RE used as a skirting

Opposite:

Top: COVING with INTERNAL and EXTERNAL ANGLES

Bottom Left: COVING with EXTERNAL ANGLES

Bottom Right: REX and RE

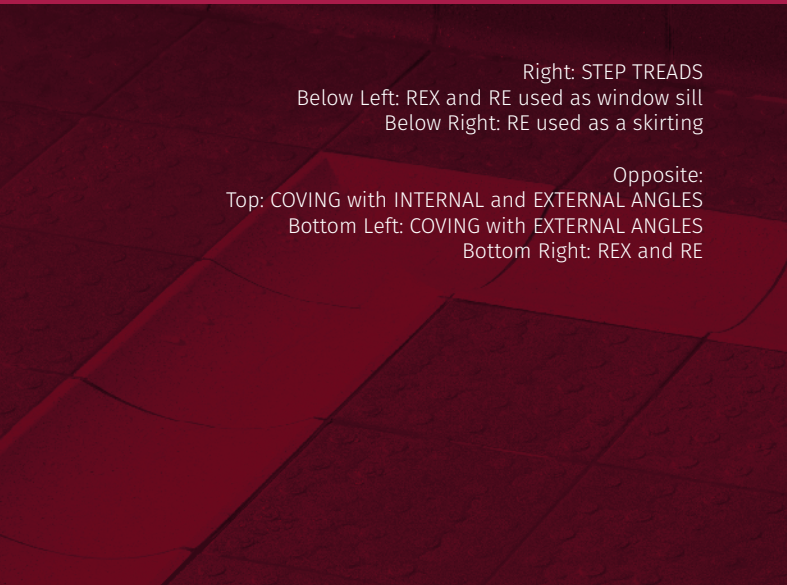

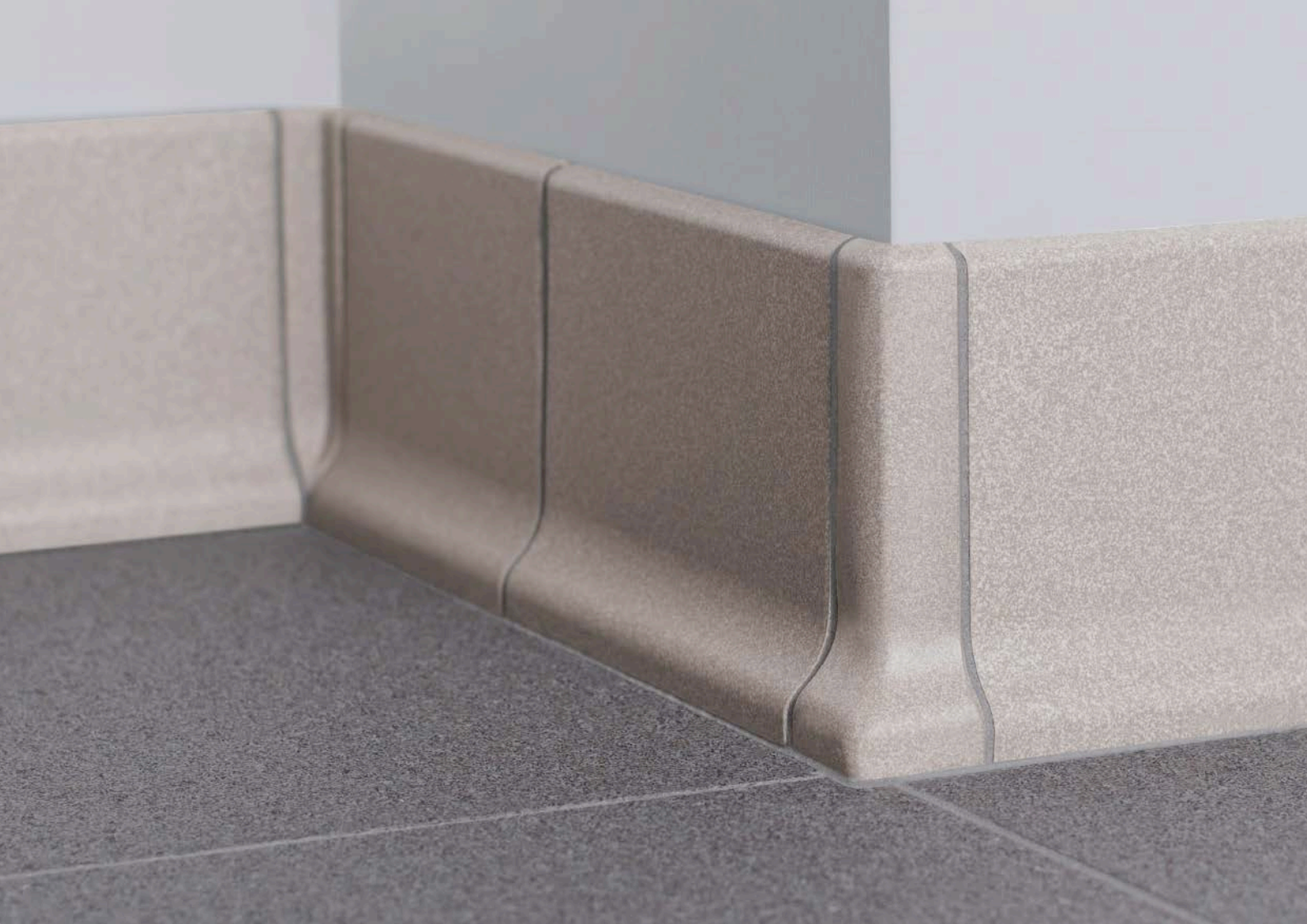

IMPORTANT INFORMATION

There is a duty of care upon all flooring designers, manufacturers, distributors, installers, contractors, and on the architects who specify flooring, to ensure that flooring surfaces are fit for purpose and do not pose any safety risks. The Equality Act imposes obligations on those concerned to offer accessible design solutions that meet the needs of everyone. This means that building designers and specifiers must consider the implications of the Equality Act and their ability to provide buildings that do not discriminate against disabled people (physical or mental impairments). To complement our slip resistant safety floor tile range, we also offer two 400 x 400 x 12.5mm tactile surfaces in 'Blister' and 'Corduroy' profiles, which conform to British and European standards and meet the requirements of the Joint Mobility Unit of the RNIB, DETR and the CAE.

When it comes to specifying a floor covering, Dorset Woolliscroft fully vitrified floor tiles are your safest choice for many different situations, both internal and external use. They all comply with, and in most cases exceed, recommended requirements and regulations after rigorous internal and independent testing.

Please read through the following information carefully. It sets out the current situation (at the time of printing this brochure) regarding current regulations, testing methods, specifications of Dorset Woolliscroft floor tiles, fixing, cleaning and maintenance information, and our limits of liability.

Please check the suitability of the floor tiles and fixings before specifying, ordering and installation. If you are uncertain, please ask your Dorset Woolliscroft supplier or contact our Customer Services Department on 01392 473030 for further information and assistance.

SLIP RESISTANCE

OUR TILES

Our Dorset Woolliscroft products are tested for slip resistance and other properties using a range of methods (see pages 49-52), and the results are included with the technical specification for each product. Please visit www.dorsetwoolliscroft.com for further information or the relevant product pages in this brochure. Our tiles have also been independently tested by Lucideon, the global expert in materials testing, analysis and consultancy. For more information please visit www.lucideon.com.

RESPONSIBILITY FOR PREVENTING SLIPS AND TRIPS

According to the Health and Safety Executive (HSE), in 2015/16 an estimated 621,000 workers sustained a non-fatal injury at work. Of these injuries 200,000 led to over 3 days absence from work, of which 152,000 led to over 7 days absence. Slipping and tripping accounted for 19% of these self-reported non-fatal injuries (non-fatal injuries to employees are substantially under-reported by employers, with current levels of reporting estimated at around a half). Source: hse.gov.uk

Currently there are a number of different standards to deal with the issue of slip resistance for floor surfaces in the UK. However the HSE outlines the responsibilities for preventing slips and trips at workplaces and public areas for flooring manufacturers, architects and designers, employers, workers and footwear manufacturers. With slips and trips being such a common health risk in most buildings, architects, specifiers and clients need to specify floors which are suitably slip resistant for their intended use not only for immediate usage but also for the longer term.

ASSESSING AND TESTING SLIP RESISTANCE

The assessment of slip resistance: The HSE approach

The law requires that floors must not be slippery so they put people's safety at risk (The Workplace (Health, Safety and Welfare) Regulations 1992).

The slipperiness of flooring materials can be accurately assessed by using commercially available, portable scientific test instruments.

Workplace health, safety and welfare. Workplace (Health, Safety and Welfare) Regulations 1992. Approved Code of Practice L24 HSE Books 1992 ISBN 07176 0413 6

The HSE has published comprehensive guidance of how and why slips and trips occur and how to prevent them. For further information, please visit www.hse.gov.uk.

We recommend that specifiers seek expert and current guidance as the research into reproducible and representative tests to measure the slip resistance of flooring materials is ongoing.

We have set out the main slip resistant measurements below to help you to choose the Dorset Woolliscroft tiles that most closely match the requirements of your installation.

TESTING METHODS

SLIP RESISTANCE

PENDULUM TEST BS7976-2 4S96 SHOD DRY/WET



This test is designed to simulate the action of a slipping foot and uses a weighted swinging arm which contacts the surface of the tile with a standard rubber slider that represents the rubber sole of a shoe in both dry and wet conditions. The slip resistance is the upswing measured from a scale on the instrument. The greater the upswing, the lower the slip resistance and the greater the slip potential.

Accepted limits for flooring using this technique shod dry/wet are:

SLIP POTENTIAL	SLIP RESISTANCE VALUE USING 4S96
High	0 to 24
Moderate	25 to 35
Low	36+

*All Dorset Woolliscroft tiles exceed the value of 36 in both wet and dry conditions.

PENDULUM TEST BS7976 PART 2 TRRL 55 BAREFOOT WET (TRANSPORT & ROAD RESEARCH LABORATORY)

As above, to determine the wet co-efficient of friction using a TRRL 55 rubber slider to represent barefoot in wet conditions.

Accepted limits for flooring using this technique barefoot wet are:

SLIP POTENTIAL	SLIP RESISTANCE VALUE TRRL 55 WET
High	19 and below
Moderate	20 to 39
Low	40 to 74

The testing is conducted in-house.

Please visit www.dorsetwoolliscroft.com for all test results

SHOE SHOD RAMP TEST DIN51130

The above tests are supplemented by the German ramp test method carried out by an external accredited laboratory.

- For testing slip resistance of a surface to shoe shod traffic tested on a ramp in the presence of a surface lubricant
- Most useful for assessing profiled tiles, or tiles to be used in areas where there is a high risk of contamination
- NB: the lowest classification is R9, and as this is not a good specification for slip resistance, it should be supported by a pendulum value. The range for R9 has recently been changed from a 3° - 10° to 6° - 10° because of problems with misinterpretation of the R9 category.

R VALUE	DEGREES
R9	6° - 10°
R10	10° - 19°
R11	19° - 27°
R12	27° - 35°
R13	36° +

*All Dorset Woolliscroft flat tiles are rated R10, all structured tiles are rated at least R11. For the full list please see pages 56-58

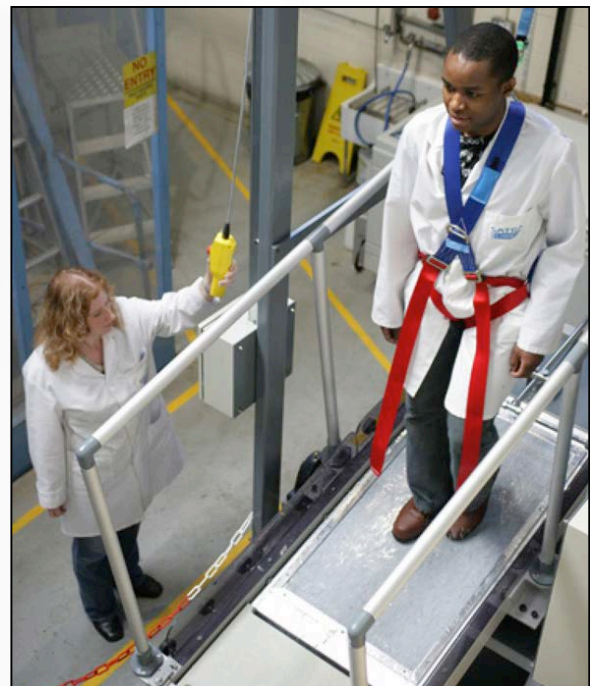

Slip readings - please note:

Values issued by Dorset Woolliscroft for slip resistance relate to the test results as supplied from Lucideon or from in-house testing. These values can change during the lifetime of a tile as a result of the following factors: Surface wear / Poor cleaning regimes / Sealants or wax coatings, correctly or incorrectly applied / Chemical exposures which may acid etch the surface / Body fats build up especially when placed in barefoot areas

If in any doubt always retest the surface on a regular basis.

TESTING METHODS

BAREFOOT RAMP TEST DIN 51097

- For testing the slip resistance of floor tiles under wet and barefoot conditions
- The tiles are fixed on a ramp which is coated with a standard lubricant. A tester walks on them with the ramp set at a succession of increasing angles until the tester slips, and the angle at which the slip occurs is recorded.
- A, B or C classifications indicate slip resistance levels. We would normally recommend that tiles for use in wet barefoot areas achieve classification B or C, depending on the incline of the floor.

CAT.	LOWER LIMIT	UPPER LIMIT	AREA
A	12°	17°	<ul style="list-style-type: none"> • Barefoot hallways (mainly dry) • Individual and group changing rooms with lockers • Pool floor in the non swimmer areas, where the water level exceeds 80cm
B	18°	23°	<ul style="list-style-type: none"> • Barefoot hallways, if not classified in A • Showers • Area surrounding the disinfectant sprayers • Pool surrounds • Pool floor in the non swimmer areas where the water level is less than 80cm in parts • Pool floor in the non swimmer areas in the tide effect pool • Lift slab areas • Paddling pools • Steps leading in to the water • Steps, of maximum 1m width with hand rails, leading into the water • Steps outside the pool area
C	>23°		<ul style="list-style-type: none"> • Steps leading into the water, if not classified in B • Foot paths • Inclined pool borders

*The Dorset Woolliscroft tiles which are suitable for wet barefoot areas are all C value. For the full list please see pages 56-58?.

DISPLACEMENT VOLUME VALUE (V)

- The displacement volume value for a floor is the measure of the space between the foot and the floor surface
- Higher values relate to a greater volume of debris that can be held by the texture without compromising the slip resistance of the tile
- Values less than V4 are not recorded

*There are a number of Dorset Woolliscroft tiles which are suitable for this type of location rated both V4 and V6 DVV. See pages 56-58.

V VALUE	VOLUME OF DEBRIS
V4	4cm ³ / dm ²
V6	6cm ³ / dm ²
V8	8cm ³ / dm ²

SURFACE ROUGHNESS MEASUREMENT (Rz)



For measuring surface micro-roughness stated as an average roughness figure in microns, RzDIN, which may be useful to assess slip risk

The valley and peak depths on the surface of a tile have a significant effect on both slip resistance and on ease of cleaning. In-house testing for surface roughness (Rz) supplements the slip test information and allows for better decision making on the suitability of the tile in particular installation environments. All Dorset Woolliscroft products are monitored for this important property.

SATRA TM144

DYNAMIC COEFFICIENT OF FRICTION TEST

- To assess the potential of slipping when walking on flooring material in footwear
- It tests the conditions of slip in different stages of the walking gait (heel strike, lift-off or shoe flat to the floor) in different inclines
- It determines the dynamic coefficient of friction (cof) between footwear outsoles and flooring surfaces under conditions simulating those experienced at the most critical parts of the typical walking step
- The value must not fall below 0.40 for both dry and wet conditions for more than 20mm traverse, taking into account the representative cycle from the centre of a 100mm trace after the first 20mm of movement in all directions under test

Please visit www.dorsetwoolliscroft.com for all test results

Slip readings - please note:

Values issued by Dorset Woolliscroft for slip resistance relate to the test results as supplied from Lucideon or from in-house testing. These values can change during the lifetime of a tile as a result of the following factors: Surface wear / Poor cleaning regimes / Sealants or wax coatings, correctly or incorrectly applied / Chemical exposures which may acid etch the surface / Body fats build up especially when placed in barefoot areas

If in any doubt always retest the surface on a regular basis.

TESTING METHODS

ACCESSIBLE DESIGN BS8300

The Equality Act 2010 imposes obligations on those concerned with the provision of services to the public in the private, public and voluntary sectors. Responding to these duties means that building designers and specifiers are required to anticipate and overcome restrictions that may prevent people with disabilities making full use of premises and surroundings.

Design solutions need to meet the needs of everyone, including those with visual impairments, simultaneously providing an attractive environment for all users. Contrasting colour schemes on critical surfaces, for example contrasting colours on step edges, help some people with visual impairments to have a heightened awareness of physical features.

LIGHT REFLECTANCE VALUE

Coloured surfaces such as tiles and fittings can be measured for their Light Reflectance Value (LRV), where a score is given on a scale of 0 to 100. Dark, matt surfaces absorb a lot of light, for example, a matt black tile typically has a LRV of 6. Light, glossy surfaces reflect most of the light, so a pure white gloss tile typically has a LRV of 85.

LIGHT REFLECTANCE VALUE (LRV) BS8493 TEST

All Dorset Woolliscroft tiles are measured in house for their Light Reflectance Value (LRV). Building regulations recommend that tiles with a 30 point LRV difference or more are selected for adjacent surfaces. BS 8300 specifies the design of buildings and their approaches to meet the needs of disabled people including LRV aspects for partially sighted people.



Please refer to the following for more information:

- BSI Code of Practice 'BS 8300:2009+A1:2010 Design of buildings and their approaches to meet the needs of disabled people'
- Building Regulations Approved Document M Access to and Use of Buildings and BS8300:2001 Amendment 1
- The Equality Act 2010 Code of Practice

HYGIENE AND SLIP RESISTANCE REQUIREMENTS IN MANUFACTURING AND FOOD PREPARATION AREAS

Current hygiene legislation, together with Health and Safety Requirements and the Construction Design and Management (CDM) Regulations, place a requirement upon the specifier, building owner and facilities manager to eliminate all foreseeable risks, by design, by layout, and by specification of materials. Many factors need to be considered when deciding upon the best surfaces for installation. Hygiene (cleanability) and slip resistance are important factors in any working environment, but they should receive special attention when being specified for food preparation areas. Please visit www.tiles.org.uk to download Technical Advice Note 7 for details regarding specifications and installation advice, and www.legislation.gov.uk for more details and the latest regulations.

Independent Research Regarding Cleanability Test results indicate that fully vitrified products are able to discourage the ingress of bacteria into the surface of the tile and facilitate the greatest ease of cleaning. Research carried out at Manchester Metropolitan University concluded that there was no significant difference in ease of decontamination between Dorset Woolliscroft fully vitrified tiles and stainless steel.

STAIN RESISTANCE

Determination of Resistance to Stains - EN 10545-14
Testing for resistance to stains is done by subjecting the tiles to various substances and then attempting to remove them using a range of cleaning regimes. The substances used are pastes, chemicals/oxidising agents and films. The Classifications are 1-5, where 1 indicates that the stain could not be removed using standard cleaning procedures and 5 indicates that the stain could be easily removed.



The Paste, Chemical/Oxidising and Film Stain test results for all Dorset Woolliscroft tiles is 5. See chart on page 56 for results.

OTHER TESTS

WATER ABSORPTION BS EN ISO 10545-3

All Dorset Woolliscroft products are measured and tested in our in-house laboratory and verified to be a fully vitrified porcelain tile with a water absorption value of < 0.5% in conformance with BS EN14411 Annex G.

MODULUS OF RUPTURE & BREAKING STRENGTH BS EN ISO 10545-4

Dorset Woolliscroft tiles exhibit high strength as verified by in-house testing results of > 1300 N. All strengths conform to BS EN 14411 Annex G.

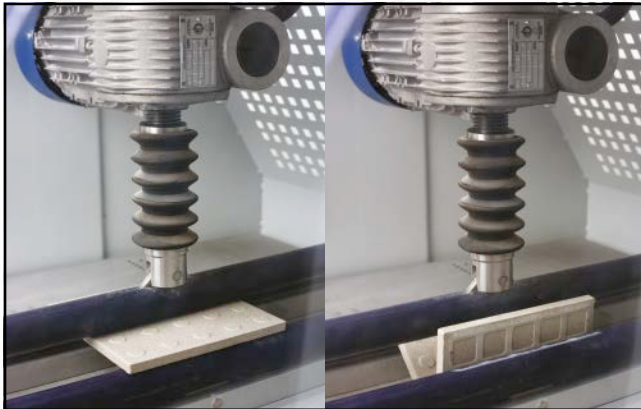

DEEP ABRASION TEST BS EN ISO 10545-6

The degree to which the surface of a floor tile will withstand abrasion is tested under given conditions by measuring loss of volume using a rotating disc and abrasive material. The results are measured as mm^3 . Hard wearing tiles must measure lower than 175mm^3 .

Testing confirms that all Dorset Woolliscroft products have a deep abrasion value for wear rating of < 175mm^3 conforming to BS EN14411 Annex G. This demonstrates they are extremely hard wearing and suitable for a whole variety of demanding environments.

This test is conducted in-house.



FIXING

Movement joints

For interior or exterior floor tile installations, movement joints should be located:

- over existing structural movement joints
- around the perimeter of the floor and where tiling abuts columns, curbs, steps and plant fixed to the base
- in large floor areas tiling should be divided into bays not exceeding 8-10m intervals. On suspended floors the bay size should be reduced and additional joints provided over supporting walls and beams

All floor tile joints should extend throughout the depth of the tile, bed and screed and should be 6-10mm in width.

They should be designed to avoid being subjected to the effect of wheeled traffic and where this is not possible metal reinforced joints should be specified.

Grouts & Adhesives

Highly pigmented grout may stain the tiles. Always test before installation.

We recommend SYSTEM ARDEX Premium Performance Screeds, Renders and Grouts to ensure a first quality installation.



CLEANING & MAINTENANCE

It is the responsibility of the owner to provide for routine inspection, appropriate maintenance, and to assure compatibility of all cleaning methods/products with grout and mortar manufacturers.

Appropriate maintenance requirements are determined by the site environment and the specific use of the installation.

All damaging contaminants must be removed from grout joints sufficiently and regularly to avoid permanent damage from exposure to food, biological waste, industrial chemicals and aggressive cleaning solutions. Consult manufacturers for recommended procedures.

Follow the cleaning procedures outlined below to ensure that all Dorset Woolliscroft floors are maintained to a high standard of cleanliness, slip resistance, hygiene and appearance.

Newly Laid Floors

There may be residual cement on the tile surface of newly laid floors. All traces of this must be removed by applying a mildly acidic decementing solution, which must be rinsed off thoroughly. Clean regularly as specified below.

Regular Cleaning

Regular cleaning with warm water (or hot water for oil and grease) and a neutral or mildly alkaline (pH to 8) detergent will remove all but the most stubborn dirt.

Mix the detergent as recommended by the manufacturer. The water/detergent mixture must be left on the floor for enough time (5-15 minutes) to allow it to penetrate and emulsify the dirt. Rinse thoroughly with clean water to remove all traces of the detergent mixture.

Large areas of plain or textured surface tiles are best cleaned with rotary, cylindrical or reversing mechanical scrubbing machines as follows:

1. Use slow to medium speed rotation. If the machine has a suction drying facility, use it first with the suction facility switched OFF. This permits the water detergent mixture used in the scrubbing process to remain on the floor to penetrate the dirt layer.
2. Leave for at least 5-15 minutes to elapse, then repeat the scrubbing operation with clean water only and with the suction drying facility switched ON. It is the rinsing process which removes the dirt.
3. Spillages of oil, fat or any material likely to stain or cause a slipping hazard should be removed immediately by using detergent and hot water, followed by a cold water rinse.
4. Use warning signs or physically exclude people from wet cleaning areas until they are completely dry.

Longer Term Maintenance

Clean the floor periodically using a rotary, cylindrical or reversing scrubbing machine with the addition of an abrasive powder or fine Silica Sand. These products scour the tiles, remove impacted dirt, and generally refresh the floor without damaging their surface. Remove the residue with clean water and rinse before it can dry out. If high velocity water jets are used for removal of stubborn dirt this will not damage the tiles, but may erode the joints if used regularly. If oil or grease is present, use the jet with warm or hot water and with a pH neutral detergent.

Please note that marks made during installation and with constant use may be more obvious on pale colours. Therefore even Dorset Woolliscroft fully vitrified tiles will require a certain amount of extra cleaning in areas prone to heavy soiling.

NB. These cleaning and maintenance instructions are Dorset Woolliscroft's recommendations and not necessarily exhaustive. The recommendations of manufacturers of cleaning equipment and materials should always be followed.

GENERAL

ENVIRONMENT AND SUSTAINABILITY

Our products are designed and manufactured with environmental issues in mind. We regularly evaluate our operations to improve in areas of energy and efficiency, reduction of emissions, ecological conservation and use of materials, and we are committed to continue to find new and innovative ways to achieve further improvements in our environmental performance.

Our waste management policy ensures that waste is minimised.

LIFE CYCLE COST AND SUSTAINABILITY

Life cycle costing is becoming increasingly important as manufacturers, architects and designers are challenged to provide and specify total cost-effective materials and solutions. Life cycle costing calculates the cost of a product over its whole lifespan, including owning, operating, maintaining, repairing, recycling and disposing. Dorset Woolliscroft fully vitrified floor tiles are Class A (A = lower overall environmental impact) and many studies support the view that porcelain tiling is the most economical flooring solution over a lifespan of 50 years.

DORSET WOOLLISCROFT SPECIFICATIONS

For detailed individual specifications of all tiles and fittings mentioned in this brochure, please visit www.dorsetwoolliscroft.com.

All Dorset Woolliscroft tiles and fittings are manufactured to conform to BSEN 14411.

SHADING

Some very slight shade variation may occur between different sized tiles of the same colour. Before fixing tiles it is important to lay them out in good light to ensure that any shade difference is evenly distributed.

PHOTOGRAPHY

Owing to variations in studio lighting and printing inks, the tile colours shown in this brochure may differ slightly from those of the actual tiles. It is always advisable to request a sample.

LIMITS OF LIABILITY

Dorset Woolliscroft accepts no liability for the faulty installation of its products. In the case of any claim relating to the tiles themselves, Dorset Woolliscroft's liability, to the extent permitted by law, is limited to either the replacement of the product or a refund of the cost of the product, and does not extend to cover any consequential loss. Claims must be reported within seven working days from receipt of the tiles. Tiles must be inspected prior to installation and claims cannot be considered after the tiles have been installed.

Please be advised that installation constitutes acceptance of the quality, colour, size, texture and shade of the tiles. Dorset Woolliscroft warrants that its tiles conform to their description and are fit for their purpose. Dorset Woolliscroft makes no other express or implied warranty as to fitness or suitability of the products for particular installations. We extend no guarantees, express or implied, as to wear resistance or maintenance procedures. It is imperative to follow grout and adhesive manufacturers' instructions regarding their suitability with our products. If in doubt please consult the grout/adhesive stockist from whom you purchased the products. Dorset Woolliscroft makes no representations as to the fitness for purpose of third party adhesives and grouts.

ACKNOWLEDGEMENTS

We gratefully acknowledge the assistance of the following companies and organisations with the photographic locations, settings and props.

Alvin Key Clamps
Bethany School Kent
Bernaville Nurseries Exeter
Chalk and Bess
C.S.G. Pollitt Ltd Exeter
Darts Farm Exeter
Harley-Davison Plymouth
London Midland
Milk Leisure
Next
Nisbets Catering
Nkuku
Pattersons Catering and Cleaning Supplies
Rugby Store
Southern Rail
South West Trains
The Junction Sports Centre Broadstone (YMCA Bournemouth)

www.alvinkeyclamp.co.uk
www.bethanyschool.org.uk
www.bernaville.co.uk
en-gb.facebook.com/chalkandbess
www.pollitts.co.uk
www.dartsfarm.co.uk
www.plymouthharley-davidson.co.uk
www.londonmidland.com
www.milkleisure.co.uk
www.next.co.uk
www.nisbets.co.uk
www.nkuku.com
www.pattersons.co.uk
www.rugbystore.co.uk
www.southernrailway.com
www.southwesttrains.co.uk
www.thejunctionbroadstone.co.uk

Skirting and bullnosing profiles can all be shaped in-house

There's no need to compromise on finishing pieces such as bullnose edging and skirting's, as these can be ordered at the same time and from the same tiles as the rest of your order. We engineer these pieces at our in-house facilities to your specific installation requirements.

Right: FLAT STEEL GREY 300mm, FLAT DARK GREY 300mm and custom skirting in FLAT DARK GREY STEP EDGES with Original Style Artworks half tile in Brilliant White

Below: In house custom shaping



TECHNICAL INFORMATION







	PTV SLIP SHOD DRY 4S96 dry	PTV SLIP SHOD WET 4S96 wet	PTV SLIP B'FOOT WET TRRL 55 wet	RAMP SLIP TEST	DISPLACEMENT VOLUME	CHEMICAL RESISTANCE	STAIN RESISTANCE	REACTION TO FIRE
FLAT	53	37	n/a*	R10 A	-	4	5	A1/A1 _{FL}
LUNA	60	54	48	R12 C	-	4	5	A1/A1 _{FL}
PINHEAD	62	54	48	R11 C	V4	4	5	A1/A1 _{FL}
MULTIDISC	70	58	44	R12 C	V6	4	5	A1/A1 _{FL}
TETRA	65	55	42	R11 C	V4	4	5	A1/A1 _{FL}
TEXTURED	56	47	47	R11 B	-	4	5	A1/A1 _{FL}
GRITSTONE AGGREGATE	58	50	n/a*	R11 [†]	-	4	5	A1/A1 _{FL}
PEBBLED AGGREGATE	60	48	n/a*	R11 [†]	-	4	-	A1/A1 _{FL}
ELITE	56	35	n/a*	R10 [†]	-	4	5	A1/A1 _{FL}

*Not suitable for barefoot use † Shod only



SATRA TM144 DYNAMIC COEFFICIENT OF FRICTION TEST							
CONDITION	ALONG		ACROSS		45°		
	CoF	DISTANCE CoF<0.4mm	CoF	DISTANCE CoF<0.4mm	CoF	DISTANCE CoF<0.4mm	
TACTILE CORDUROY	DRY	0.49	5	0.64	15	0.61	0
	WET	0.44	5	0.53	17.5	0.60	5
		PASS	PASS	PASS	PASS	PASS	PASS

SATRA TM144 DYNAMIC COEFFICIENT OF FRICTION TEST							
CONDITION	ALONG		ACROSS		45°		
	CoF	DISTANCE CoF<0.4mm	CoF	DISTANCE CoF<0.4mm	CoF	DISTANCE CoF<0.4mm	
TACTILE BLISTER	DRY	0.80	10	0.77	10	0.59	5
	WET	0.70	5	0.64	10	0.54	0
		PASS	PASS	PASS	PASS	PASS	PASS

TILE SIZE & COLOUR GUIDE

L x W x D (mm)	STEEL GREY  LRV 35	DARK GREY  LRV 16	QUARTZ  LRV 37	STONE  LRV 46	WHITE  LRV 52	RED  LRV 12	BLACK  LRV 9
148 x 148 x 9 300 x 300 x 9	DW-FLSGR1515 DW-FLSGR3030	DW-FLDGR1515 DW-FLDGR3030	DW-FLQUZ1515 DW-FLQUZ3030	DW-FLSTO1515 -	DW-FLWHT1515 -	DW-FLRED1515 -	DW-FLBLK1515 -
148 x 148 x 9 300 x 300 x 9	DW-LUSGR1515 DW-LUSGR3030	DW-LUDGR1515 DW-LUDGR3030	DW-LUQUZ1515 DW-LUQUZ3030	-	DW-LUWHT1515 DW-LUWHT3030	-	-
148 x 148 x 9	DW-PHSGR1515	DW-PHDGR1515	DW-PHQUZ1515	DW-PHSTO1515	DW-PHWHT1515	DW-PHRED1515	DW-PHBLK1515
148 x 148 x 9	DW-MDSGR1515	DW-MDDGR1515	DW-MDQUZ1515	-	DW-MDWHT1515	-	-
148 x 148 x 9 300 x 300 x 9	DW-TESGR1515 DW-TESGR3030	DW-TEDGR1515 DW-TEDGR3030	DW-TEQUZ1515 DW-TEQUZ3030	-	DW-TEWHT1515	-	-
300 x 300 x 9	DW-TXSGR3030	DW-TXDGR3030	DW-TXQUZ3030	-	-	-	-
300 x 300 x 9	DW-GASGR3030	DW-GADGR3030	DW-GAQUZ3030	-	-	-	-

L x W x D (mm)	SPECKLED STEEL GREY LRV 29 	SPECKLED DARK GREY LRV 14 
300 x 300 x 11	DW-PASSG3030	DW-PASDG3030



L x W x D (mm)	LIGHT GREY LRV 31 	CHARCOAL LRV 19 
300 x 300 x 12	DW-ELLGR3030	DW-ELCHC3030

All products are fully vitrified, making them frost proof and suitable for external use

Nominal dimensions are stated, which are subject to slight variation within internationally accepted standards

Where applicable, tiles conform to BS EN 14411 2016

Full test results are available at www.dorsetwoolliscroft.com

L x W x D (mm)	SAND LRV 46 	ANTHRACITE LRV 8 
400 x 400 x 12.5 (exc. protrusions)	DW-TCSND4040	DW-TCANT4040

Tactile Corduroy and Blister tiles meet the requirements of London Underground E6464 A2 Engineering Standard – Rolling Stock Floor Coverings. Section 8.4 (SATRA TM144) Slip Resistance of Profiled Floors.

L x W x D (mm)	SAND LRV 46 	ANTHRACITE LRV 8 
400 x 400 x 12.5 (exc. protrusions)	DW-TBSND4040	DW-TBANT4040

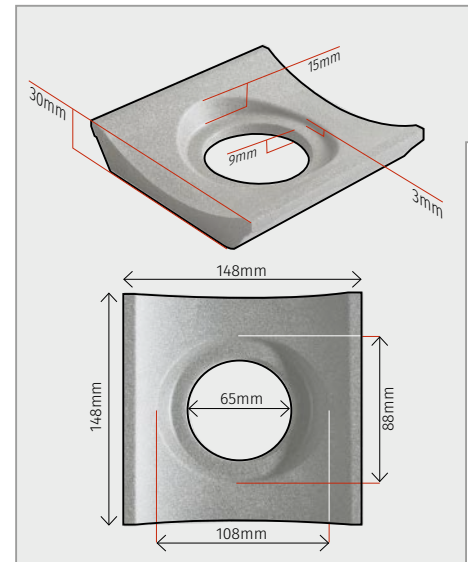



PRODUCT GUIDE

fold out for the complete range

**DORSET
WOOLLISCROFT**

The Safest Choice in Floor Tiles

A LONG HISTORY OF TILE MAKING

















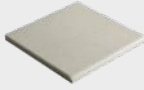
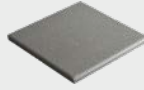





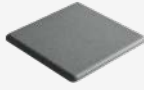



































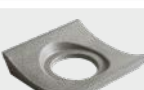

Poole in Dorset was the starting place of Carter & Co, a tile making company established in 1873. The company took over Poole Pottery in the 1920s, later becoming part of Pilkington's Tiles in 1964. In another part of the country, George Woolliscroft & Son were making tiles from around 1884 at Etruria and Hanley in Staffordshire, a location closely associated with Josiah Wedgwood. They produced a wide range of tiles, including tile blanks for other tile decorating companies.

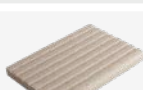
They concentrated on floor tiles from 1910, supplying tiles for many locations including the London Underground.

In 2000 Pilkington's Tiles took the company over and the floor tile range became Dorset Woolliscroft, bringing together two names which symbolised high quality, hard wearing porcelain tiling. Then in 2010 the Dorset Woolliscroft brand was acquired by Original Style – giving it a new lease of life to ensure its continuation and success for many more decades.

GUIDE

FITTINGS GUIDE

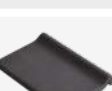
L x W x D (mm)	STEEL GREY  LRV 35	DARK GREY  LRV 16	QUARTZ  LRV 37	STONE  LRV 46	WHITE  LRV 52	RED  LRV 12	BLACK  LRV 9
ROUND EDGE (RE) 148 x 148 x 9	 DW-RESGR1515	 DW-REDGR1515	 DW-REQUZ1515	 DW-RESTO1515	 DW-REWHT1515	 DW-RERED1515	 DW-REBLK1515
ROUND EDGE EXT. (REX) 148 x 148 x 9	 DW-RXSGR1515	 DW-RXDGR1515	 DW-RXQUZ1515	 DW-RXSTO1515	 DW-RXWHT1515	 DW-RXRED1515	 DW-RXBLK1515
COVING 148 x 109 x 9	 DW-CVSGR1511	 DW-CVDGR1511	 DW-CVQUZ1511	 DW-CVSTO1511	 DW-CVWHT1511	 DW-CVRED1511	 DW-CVBLK1511
COVING EXT. ANGLE 109 x 30 x 9	 DW-CESGR1103	 DW-CEDGR1103	 DW-CEQUZ1103	 DW-CESTO1103	 DW-CEWHT1103	 DW-CERED1103	 DW-CEBLK1103
COVING INT. ANGLE 109 x 30 x 9	 DW-CISGR1103	 DW-CIDGR1103	 DW-CIQUZ1103	 DW-CISTO1103	 DW-CIWHT1103	 DW-CIRED1103	 DW-CIBLK1103
CHANNEL STOP 148 x 148 x 12		 DW-CSDGR1515	 DW-CSQUZ1515		 DW-CSWHT1515		
CHANNEL STRAIGHT 148 x 148 x 12		 DW-CADGR1515	 DW-CAQUZ1515		 DW-CAWHT1515		
CHANNEL CORNER 148 x 148 x 12		 DW-CRDGR1515	 DW-CRQUZ1515		 DW-CRWHT1515		
CHANNEL OUTLET 148 x 148 x 12		 DW-CTDGR1515	 DW-CTQUZ1515		 DW-CTWHT1515		
STEP TREAD 148 x 100 x 12		 DW-STDGR1510	 DW-STQUZ1510		 DW-STWHT1510		 DW-STBLK1510
STEP TREAD CORNER 100 x 100 x 12		 DW-SADGR1010	 DW-SAQUZ1010		 DW-SAWHT1010		 DW-SABLK1510
POOL GRIP 148 x 109 x 12					 DW-PGWHT1510		 DW-PGBLK1510

DORSET WOOLLISCROFT

The Safest Choice in Floor Tiles

Dorset Woolliscroft and Designworks Tiles are part of the Original Style group

designworks:tiles

ARCHITECTS / SPECIFIERS /
DESIGN PROFESSIONALS contact:

01392 473030 / info@dorsetwoolliscroft.com

ORIGINALSTYLE

OTHER ENQUIRIES contact:

UK: 01392 473006 / EXPORT: +44 (0)1392 473001

Fax: +44 (0)1392 473003

www.dorsetwoolliscroft.com

The Dorset Woolliscroft logo is a registered trade mark of Original Style Ltd. Registered in England number 3018117.
Registered Office: Falcon Road, Sowton Industrial Estate, Exeter EX2 7LF. Part of the Original Style Group
©Copyright Original Style 2017

DWBROCH3 01/18