

**TURBO
RACING**

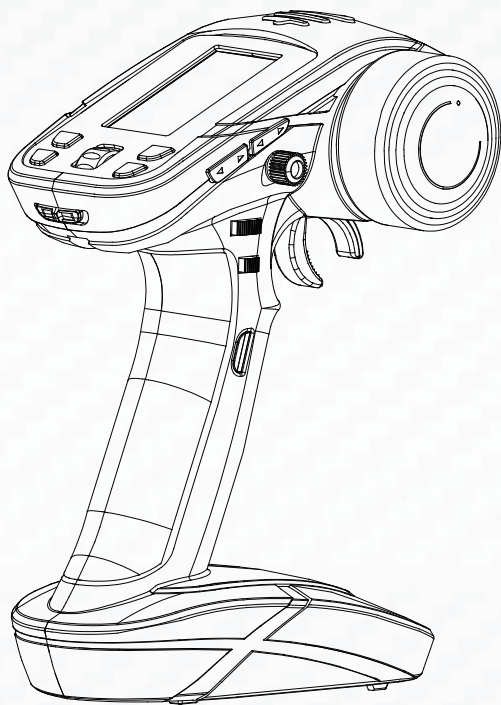

TB - TX2
LCD
TRANSMITTER KIT

2.4 GHZ FHSS DIGITAL PROPORTIONAL RADIO CONTROL SYSTEM

Introduction

Thank you for purchasing our product, an ideal radio system for beginners or experienced users.

In order to ensure your safety, and the safety of others, read this manual carefully before using this product. If you encounter any problem during use, refer to this manual first. If the problems persists, contact your local dealer or visit our service and support website: www.blqhobby.com

Copyright ©2018 NewStone Technology co.,ltd



This safety warning must be strictly implemented. As company policy shall not be liable for any loss caused by failure to comply with the safety warning. Should you ignore the operating and safety instructions, the warranty will be void.

This product is not a toy, its operation must be learned step by step. And only suitable for people who over 14 years. Please do not let children operate the model, and be careful when have children on site when operating models.

SAFETY

Pay close attention to the following symbols and their meanings. Failure to follow these warnings could cause damage, injury or death.

	Danger	• Not following these instructions may lead to serious injuries or death.
	Warning	• Not following these instructions may lead to major injuries.
	Attention	• Not following these instructions may lead to major injuries.

SAFETY GUIDE



PROHIBITED



MANDATORY



- Do not use the product at night or in bad weather like rain or thunderstorm. It can cause erratic operation or loss of control.
- Do not use the product when visibility is limited.
- Do not use the product on rain or snow days. Any exposure to moisture (water or snow) may cause erratic operation or loss of control.
- Interference may cause loss of control. To ensure the safety of you and others, do not operate in the following places:
 - Near any site where other radio control activity may occur
 - Near power lines or communication broadcasting antennas
 - Near people or roads
 - On any body of water when passenger boats are present
- Do not use this product when you are tired, uncomfortable, or under the influence of alcohol or drugs. Doing so may cause serious injury to yourself or others.
- The 2.4GHz radio band is limited to line of sight. Always keep your model in sight as a large object can block the RF signal and lead to loss of control.
- Never grip the transmitter antenna during operation. It significantly degrades signal quality and strength and may cause loss of control.
- Do not touch any part of the model that may generate heat during operation, or immediately after use. The engine, motor or speed control, may be very hot and can cause serious burns.



- Misuse of this product may lead to serious injury or death. To ensure the safety of you and your equipment, read this manual and follow the instructions.
- Make sure the product is properly installed in your model. Failure to do so may result in serious injury.
- Make sure to disconnect the receiver battery before turning off the transmitter. Failure to do so may lead to unintended operation and cause an accident.
- Ensure that all motors operate in the correct direction. If not, adjust the direction first.
- Make sure the model flies within a certain distance. Otherwise, it would cause loss of control.

TRANSMITTER OVERVIEW

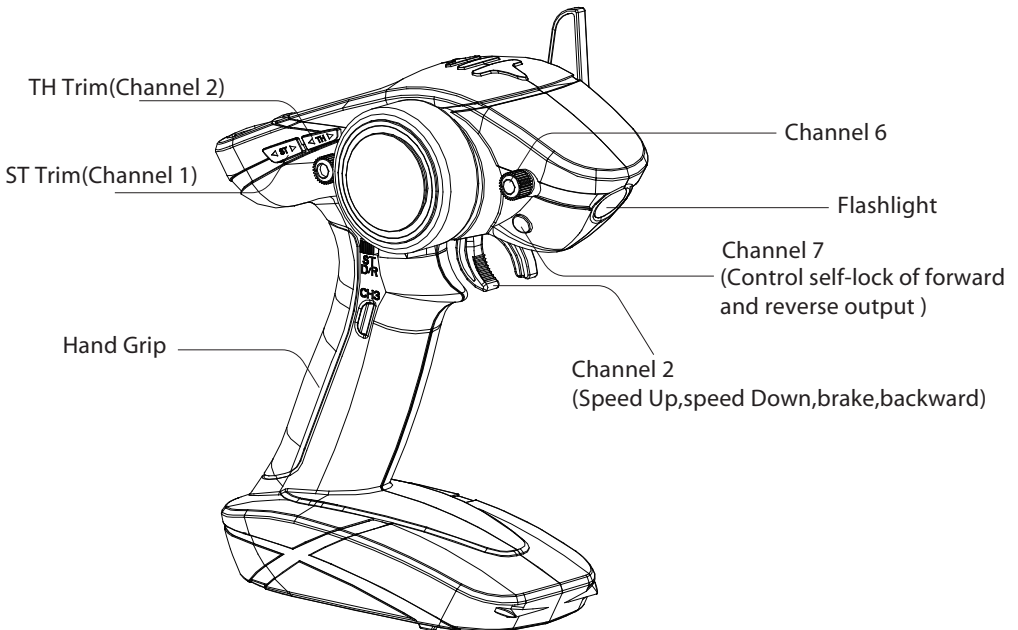
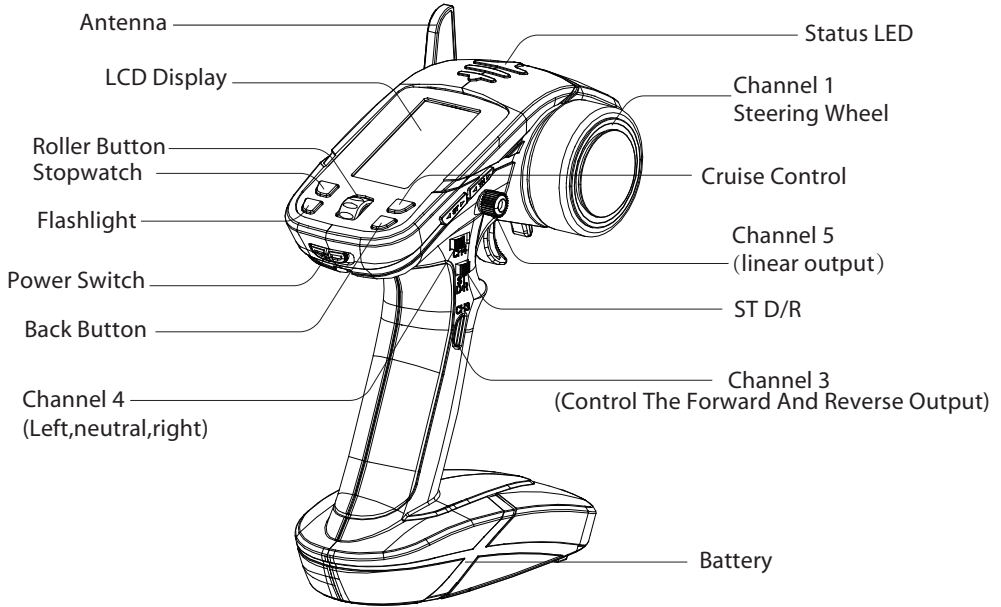

• For more information please refer to (Function Settings)

TRANSMITTER BATTERY INSTALLATION

Before operation, install the battery and connect the system as instructed below.

	Danger	Only use specified batteries (X4 AA batteries).
	Danger	Do not open, disassemble, or attempt to repair the battery.
	Danger	Do not crush/puncture the battery, or short the external contacts.
	Danger	Do not expose to excessive heat or liquids.
	Danger	Do not drop the battery or expose to strong shocks or vibrations.
	Dange	Always store the battery in a cool,dry place.
	Danger	Do not use the battery if damaged.

INSTALL THE TRANSMITTER BATTERIES

Insert new batteries if the LED display flashes or the buzzer sounds.

1. Remove the transmitter battery cover.
2. Insert new AA Mignon batteries / rechargeable batteries. Pay attention to the correct polarity.

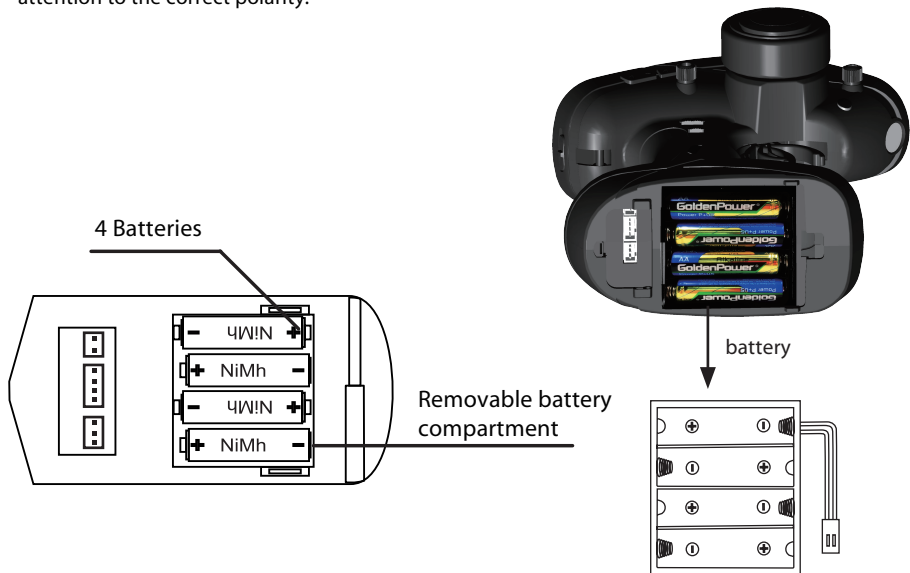

RECEIVER OVERVIEW

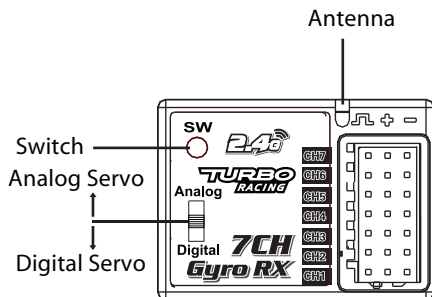

Connectors

1. Steering servo (CH1)
2. Throttle servo (CH2)
3. CH3 servo (CH3)
4. CH4 servo (CH4)
5. CH4 servo (CH5)
6. CH4 servo (CH6)
7. CH4 servo (CH7)

RECEIVER CONNECTION

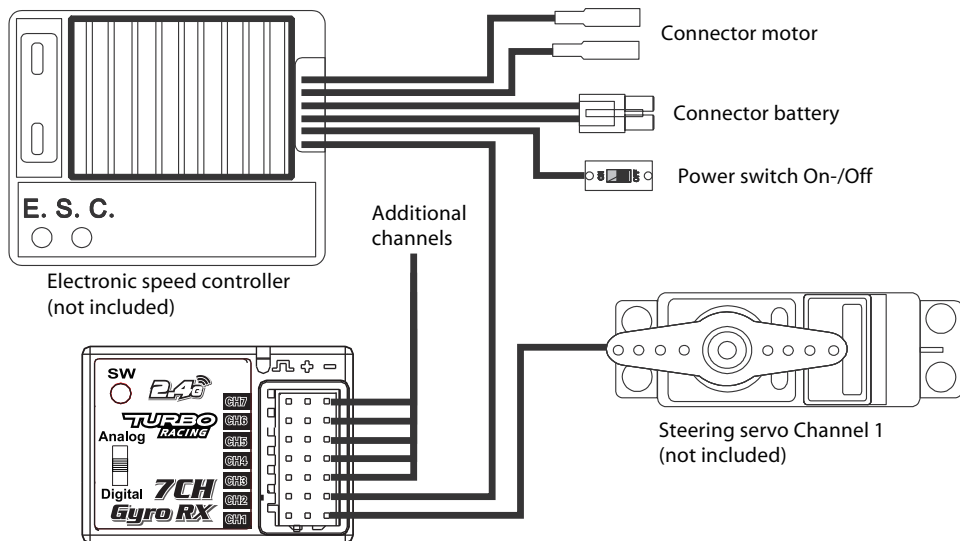

Receiver make sure to connect in correct direction.

ATTENTION
Make sure that male and female connectors have the correct polarity!

STATUS INDICATOR

The status indicator is used to indicate the power and working status of the receiver.

1. Off: The power is not connected.
2. Lit in red: The receiver is on and working.
3. Flashing slowly: The bound transmitter is off signal is lost.

CONNECTORS

Used to connect to the model and servos.

ANTENNA USE

Do not point the antenna directly at the model.



Note

Never grip the transmitter antenna during operation. It significantly degrades the RF signal quality and strength and may cause loss of control.



Caution

For best signal quality, ensure that receiver is mounted away from motors or metal parts.

Do not pull the receiver antenna into a knot or tie it to the other wire.

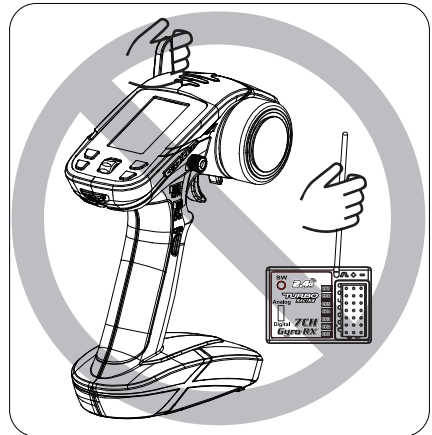
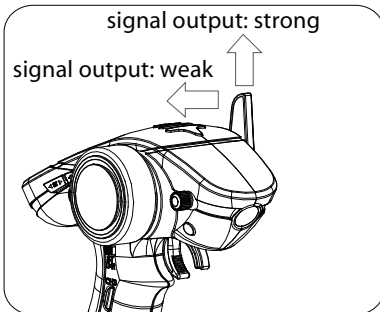

CONNECTING THE RECEIVER AND SERVOS

Connect the receiver and the servos as indicated below:

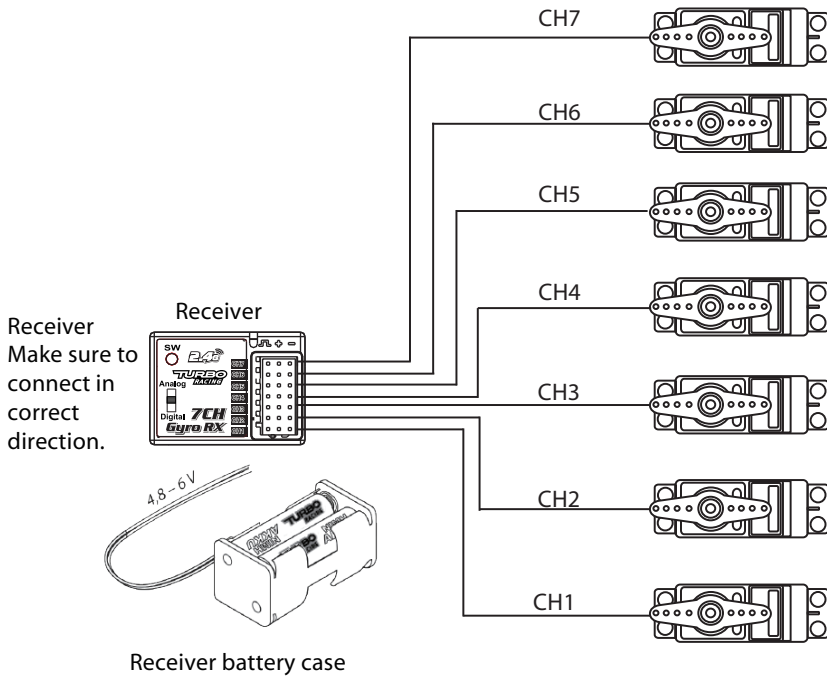

ATTENTION

Make sure that male and female connectors have the correct polarity!
When connecting servo leads to the receiver always ensure that the yellow lead/wire is facing inwards (towards the crystal).

OPERATION INSTRUCTIONS

After setting up, follow the instructions below to operate the system.

POWER ON

Follow the steps below to turn on the transmitter:

1. Make sure that:
 - The battery is fully charged and installed correctly.
 - The receiver is installed correctly and powered down.
2. Move the power switch to the(On) position.
3. Connect the power supply to the receiver.

<p>Note</p>	Make sure that the throttle is at its lowest position and the switches are set to their up position.
	Operate with caution in order to avoid damage or injury.

BINDING THE TRANSMITTER AND RECEIVER

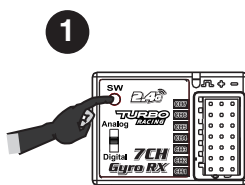

1. Turn on the receiver power. Press the SW switch. The receiver's LED should start flashing.

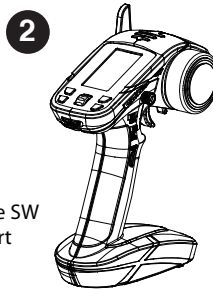

2. Turn on the transmitter.

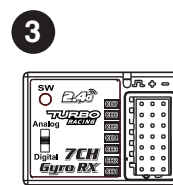

3. When the LED on the receiver becomes solid, the binding process is completed.

Attention

Keep the transmitter and receiver not over 40 cm apart when setting and binding.

During the binding process no other transmitter should be operated in the vicinity at the same time!

PRE-USE CHECK

Before operating, perform the following steps to check the system:

1. Check to make sure that all servos and motors are working as expected.
2. Check operating distance: one person hold the transmitter, and another one moves the model away from the transmitter. Check the model and mark the distance from where the model starts to lose control.
 - The range in the specifications was tested without interference from the ground and as a result the range may vary under different conditions.

<p>Danger</p>	Stop operation if any abnormal activity is observed.
<p>Danger</p>	Make sure the model does not go out of range.
<p>Attention</p>	Sources of interference may affect signal quality.

TRANSMITTER HANDLING

A. STEERING WHEEL

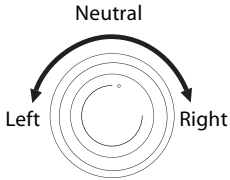

B. THROTTLE TRIGGER

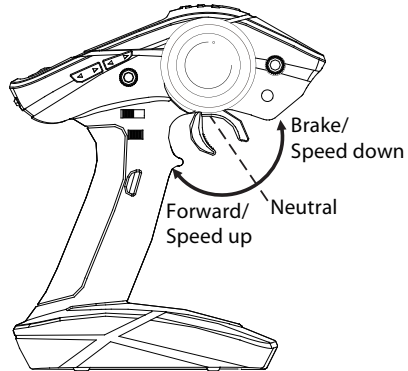

Important!!!

Should there continue to be no connection between the transmitter and the receiver, a "binding" procedure has to be conducted as well.

To do this, please keep in mind the previous point "Connection of the transmitter and receiver".

OPERATING PROCEDURE

Many publications say that the setup sequence for the transmitter and receiver don't play a role anymore with 2.4 GHz sets. However, we recommend sticking to the sequence typical for previous sets.

- Before operation: Connect the drive battery to the control unit. First turn on the transmitter, then the receiver.
- After operation: Disconnect the battery from the control unit. Turn the receiver off, and then the transmitter.
- Before and after operating the transmitter, make sure that trim is in the desired place and that all checks have been made.

	<p>Danger</p> <p>Make sure to disconnect the receiver power before turning off the transmitter. Failure to do so may lead to damage or serious injury.</p>
--	---

SYSTEM INTERFACE

The main interface mainly displays information related to the model, such as transmitter voltage, function status and so on.

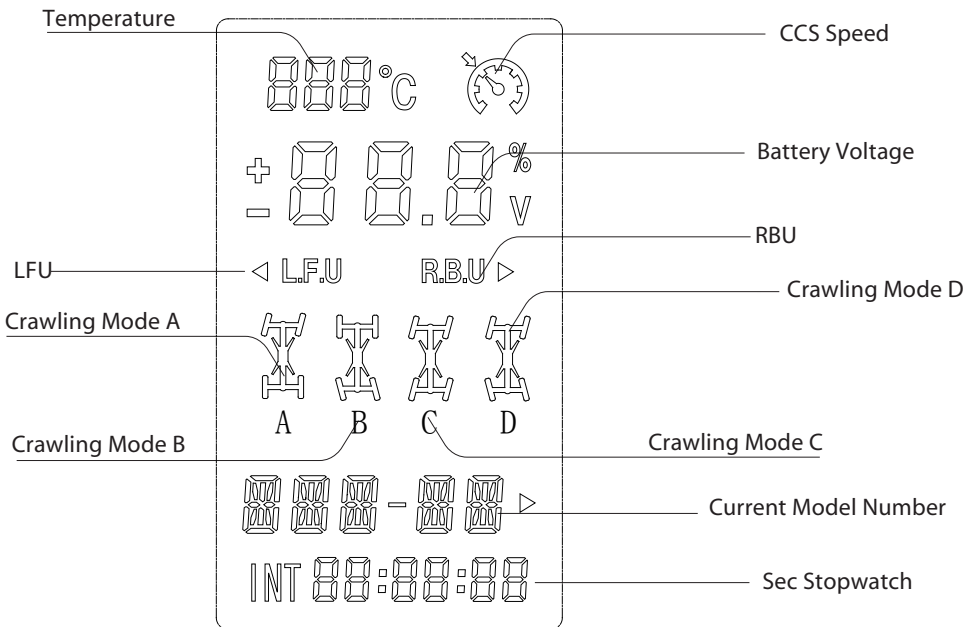

1. MOD (MODEL SELECTION)

- This transmitter can store 15 sets of models (01-15) to adapt different model products to quickly invoke saved Settings.

Feature Set:

- Under the boot menu, enter the selection menu by pressing the wheel.
 - a. Press the wheel key again to enter number 01, and then rotate the required model number through the wheel.
 - b. After setting, press BACK button to return to the main page and save.

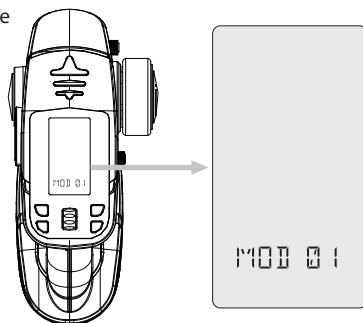

2. NAM (MODEL NAME)

- This function is to number the name of the machine type stored by the transmitter (use 3 characters). To facilitate memory and invoking, the below characters can be used:
0 1 2 3 4 5 6 7 8 9 A B C D E F G H I J K L M N O P Q R S T U V W X Y Z

Feature Set:

- Under the boot menu, enter the selection menu by pressing the scroll wheel.
 - a. Rotate the wheel to (NAM) menu, press the wheel to enter the menu operation.
 - b. At this moment, the first character of the model name flashes, and scroll wheel selects the required number or letter.
 - c. Press the wheel to select the next character. Repeat steps 2-3 to select the required number or letter.
 - d. After setting, press BACK button to return to the main page and save.

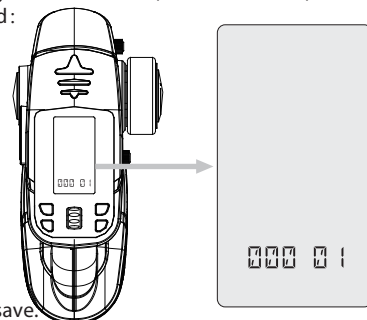

3. TRIM (FINE TUNING)

- This function is used to adjust the middle position of the throttle.CH3. CH4.

Feature Set:

- If it is found that the handwheel or trigger is in the middle position, but the driving direction of the model is somewhat offset, you can use the fine-tuning shortcut key to correct the problem.
- This function can only adjust 4 channels, they are the direction, throttle, CH3. CH4 channels, The adjustment range of RBU.LFU are 0-100 each.
- The external TRIM key of the transmitter can be adjusted quickly. More details please refer to (Transmitter overview).
- Under the boot menu, enter the selection menu by pressing the scroll wheel:
 - a. Rotate the wheel to the (TRIM) menu and press the wheel to enter the menu operation.
 - b. You can see the ST/TH 3CH 4CH menu, then press the wheel to enter, and rotate the wheel key + - to the required value.
 - c. After setting, press BACK button to return to the main page and save.

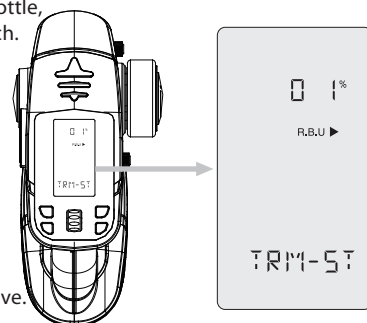

4. D/R (DUAL RATE)

• DR function is used for adjust the maximum value at both ends of the channel, and to reduce or enlarge at the same rate. Default 100% maximum.

Feature Set:

- This function is used for adjust the ratio of direction or throttle channel, and the adjustment range is between 0 and 100%.
 - Under the boot menu, enter the selection menu by pressing the scroll wheel:
- Rotate the wheel to (DR) menu, press the wheel to enter the menu operation; Select ST or TH, and set the value required.
 - After setting, press BACK button to return to the main page to save There's a DR shortcut key for quick adjustment.

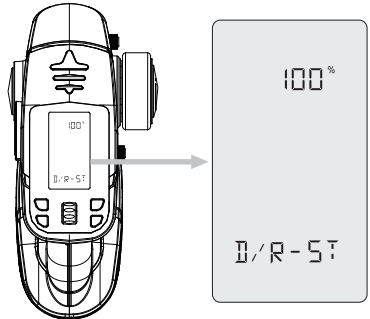

5. EPA (SETTING (SERVO TRAVEL LIMITER))

• This function is used for set the maximum servo travel limiter of each channel and adjust the maximum servo travel limiter according to the model structure.

Feature Set:

- This function can adjust the maximum servo travel limiter of 6 channels, and the desired value can be set between between 0 and 120%.
 - Under the boot menu, enter the selection menu by pressing the scroll wheel:
- Turn the wheel to the (EPA) menu and press the wheel to enter the menu operation.
 - Select the channel which need to be adjusted.
 - Select the wheel (LFU or RBU) . At this point, the percentage is 100% (the default value of the system), and then set the required value by rotating the wheel key.
 - After setting, press BACK button to return to the main page and save.

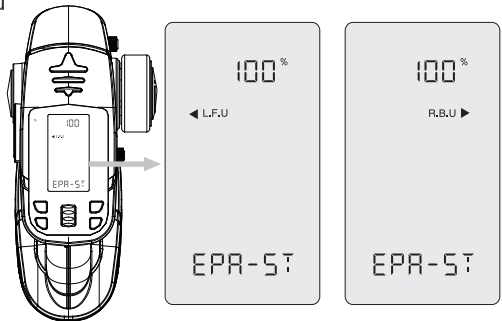

6. EXP (CURVE)

• The function of EXP is used for adjust the curve linearity of the output of the rocker channel. When the value is 0, 0%, the curve is linear, and it can be set to positive value or negative value. The positive value will reduce the sensitivity near the median and increase the sensitivity at both ends, while the negative value will increase the sensitivity near the median and decrease the sensitivity at both ends.

Feature Set:

- This function can adjust the direction and the curve of the throttle channel, the adjustment range is between -100% and 100%.
 - Under the boot menu, enter the selection menu by pressing the scroll wheel.
- Rotate the wheel key to (EXP) menu, press the wheel to enter the menu operation.
 - Select the channel which need to be adjusted.
 - Operating the channel corresponding to the rotating wheel to plus or minus a percentage, set the required value.
 - After setting, press BACK button to return to the main page and save.

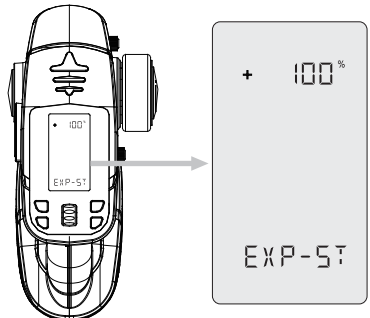

7. REV (REVERSE DIRECTION)

• This function is used for correct the control direction of servo or motor.

Feature Set:

- This function can set the forward and reverse of 6 channels.
- Under the boot menu, enter the selection menu by pressing the scroll wheel.
- a. Rotate the wheel to (REV) menu, press the wheel to enter the menu operation.
- b. Select the channel which need to be adjusted.
- c. Press the wheel to enter, and select REV or NOR through the wheel.
- d. After setting, press BACK button to return to the main page and save.

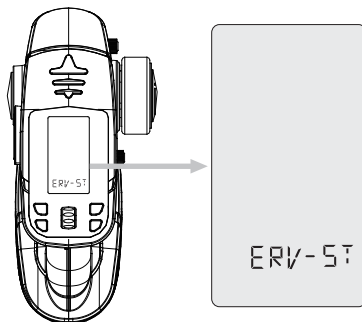

8. ABS (ANTI-BLOCKING SYSTEM)

• This function is used for setting anti-blocking to the throttle output channel (inching braking) , to adapting different kinds of racing track and the operation habits of different people, to achieve the best braking effect and the control effect of cornering, without the occurrence of tail swing and insufficient turns.

Feature Set:

- This function only can adjust the throttle channel.
- a. Rotate the wheel to the (ABS) menu, press the wheel to enter the menu operation.
- b. Press the wheel to enter, and select ON or OFF by rotating the wheel.
- c. After setting, press BACK button to return to the main page and save.

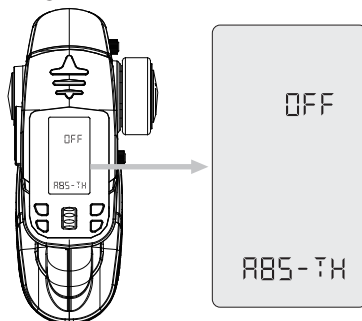

9. CRAWL (CLIMBING MODE)

- This function is used for setting mixed control of direction wheels, suitable for climbing vehicles which both front and rear wheels can be set with steering. The default is OFF.
- There are four modes of climbing car mode A, B, C and D. In climbing car mode, CH3 will be assigned to the rear wheel steering, which can not be in dependent controlled by the buttons.

Feature Set:

- a. Control front wheel steering.
 - b. Control rear wheel steering.
 - c. Control the front and rear wheels in the same direction.
 - d. Control front wheel forward, rear wheel with reverse output.
1. Press the scroll key to enter the(CRAWL) menu operation.
 2. Press the wheel to enter, and select the required function by rotating the wheel.
 3. After setting, press BACK button to return to the main page and save.

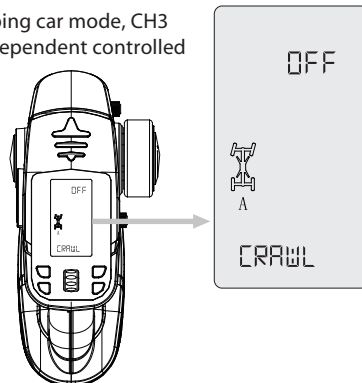

10. SVC (SMART VEHICLE CONTROL)

Note: the smart vehicle control function is only applicable to transmitter and tb-rx200 receiver as a set.

- The smart vehicle control function can use for the gyroscope of the receiver to control the direction of the vehicle intelligently, which can guarantee the vehicle to run normally in the expected direction even in the case of road bumps or sharp turns.
- Under the smart vehicle control menu, you can make some Settings.
- SVC.ON(turn on smart vehicle control) (Factory default is OFF)

Feature Set:

- Rotate the wheel key to the (SVC) menu, press the wheel key to enter the menu operation.
- The default is (L 00) 0-15. The larger the number is, the larger the adjustment range is. And rotating the wheel to select required function.
- After setting, press BACK button to return to the main page and save.

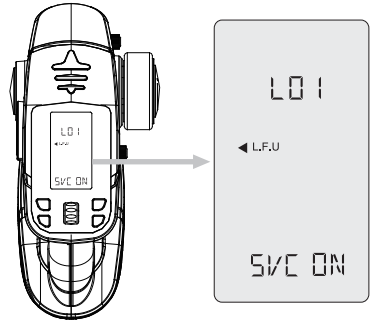

11. F/S (FAIL-SAFE)

- This function is applied to move the servo arm to the preset position to protect the model and person safety when the receiver cannot receive the transmitter signal normally.
- This function is used for adjust the direction, throttle channels.

Feature Set:

- Turn the wheel to (F/S) menu and press the wheel to enter the menu operation.
- Press the wheel and enter the channel which need to be set. When setting ST, rotate the handwheel to the position to be set; when setting the throttle, pull the trigger down to the position to be set. After that, the receiver LED lamp will flash rapidly with 2S and indicates successful setting.
- After setting, press BACK button to return to the main page and save.

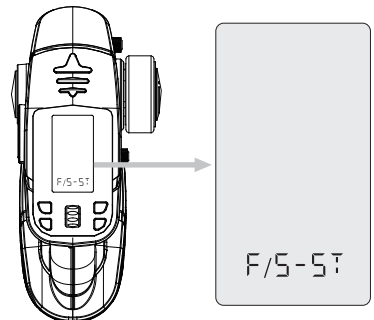

12. RST (RESTORE FACTORY SETTING)

• Before use this function, it should be cleaning up previous setting, one key to restore factory setting shortcut key, there are two modes to restore factory setting.

1. RST-M only restore the current model.
2. RST-R Restore all Settings.

Feature Set:

- a. Turn the wheel to the (RST) menu and press the wheel to enter the menu operation
- b. Entering through wheel, RST-M or RST-R, press the wheel to confirm, the buzzer will be buzzing for 2S when RST-M is set, and the throttle LED signal lamp will flash quickly, indicating the setting is successful. When the RST-R is set, the buzzer will be buzzing for 5S, and the throttle LED signal lamp will flash rapidly, indicating the setting is successful.

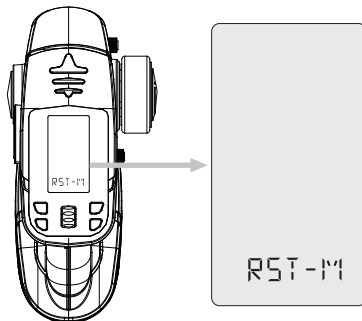

13. T/V (VOLTAGE MODE)

- This function is used for measuring LIPO battery voltage.
- This function only supports 2S or 3S LIPO batteries.

functional operation:

- a. Rotate the wheel to the (T/V) menu, enter the menu operation.
- b. Press the wheel to enter, and plug in the corresponding LIPO battery. 2 and 3 cells have different slots, which will show the current total battery number, total voltage. And can view the single battery voltage by rotate the wheel.

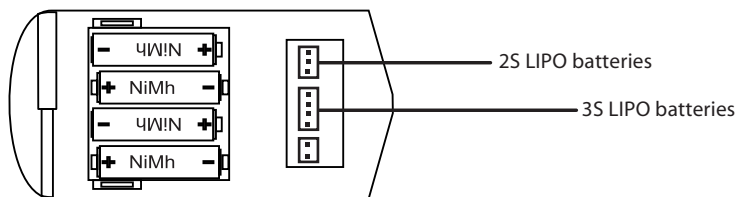
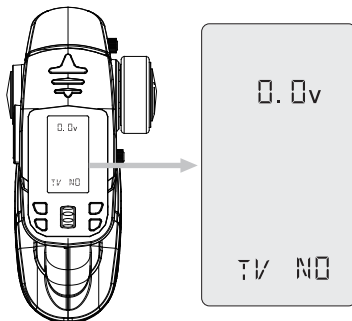

14.T/T (TEMPERATURE MODE)

- This function is used for measure the temperature of external equipment.

functional operation :

- Turn the wheel to the (T/T) menu, enter the menu operation.
- It can measure temperature when the temperature probe touched external equipment.

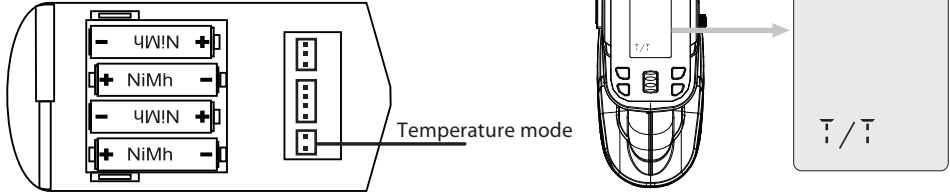

SEC (STOPWATCH FUNCTION)

- The stopwatch function is mainly used for record the time.

functional operation :

- Press the shortcut key SEC, start counting, press again for pause, press again to continue, long press 15 for clearance.

CCS (CRUISE CONTROL SYSTEM)

- The abbreviation of CRUISE CONTROL SYSTEM is CCS, also known as the CRUISE CONTROL device, speed CONTROL SYSTEM, automatic driving SYSTEM, etc. The function is to set the speed according to the player's requirement and maintain the speed automatically without pulling the trigger, so that the vehicle can drive at a fixed speed.

Function entry :

- Pull down the forward throttle to the position which needed to be set, the corresponding scale value will be displayed on the screen, and the adjustable atmosphere (000-120) can be set by pressing the CCS shortcut key, and then the CCS will be showed on the screen, indicating that the setting is successful.

Exit operation:

- Press CCS to exit
- Pull back the trigger to exit

LED (FLASHLIGHT)

- Flashlight mode, mainly use for looking accessories when fixing model car while at night time or under poor light conditions.
- The LED button is OFF,ON, which means press one time to turn on and press again to turn off

THROTTLE SIGNAL LAMP MODE

- The signal lamp including three super bright blue LEDs.
- The screen lights up while startup, LED signal lamp blinking then turn off. The throttle signal indicator is off without operation. When the user pulls the trigger, the LED signal lamp will be light up with equivalent number according to the amplitude of the user's pulling the trigger.

SPECIFICATION**Transmitter (TB-TX2)**

Suitable model	vehicle / boat
Channel number	7CH
Frequency range	2405-2478GHz
Waveband width	1MHz
Waveband number	74
Transmit Power	<20dBm
Modulation Mode	GFSK
Channel delay	< 20ms/10ms
Low-voltage alarming	When voltage lower to 4.4v of AA battery; or lower to 7.2v of two Lipo batteries
Antenna length	200mm
Display	NTN, LED
Ground distance	120m
Working current	50MA
Channel data	Neutral: 1500us, Range: 800-2200us
Dimention	170.5x197.4x101.5mm
Weight	300g
Certificate	CE FCC ROHS

Receiver (TB-RX200)

Channel number	7CH
Frequency range	2405-2478GHz
Waveband number	78
Receiver sensitivity	-92dBm
Gyroscope sensitivity	0-15
Modulation Mode	GFSK
Input power	4.0-8.4V DC
Weight	15g
Dimention	36x26x14mm
Certificate	CE FCC ROHS



NEW STONE TECHNOLOGY CO.,LTD
www.blqhobby.com