



KEEP SAFE ▶

INSTRUCTION MANUAL

ISS

INTERNATIONAL
SPACE STATION

3/3

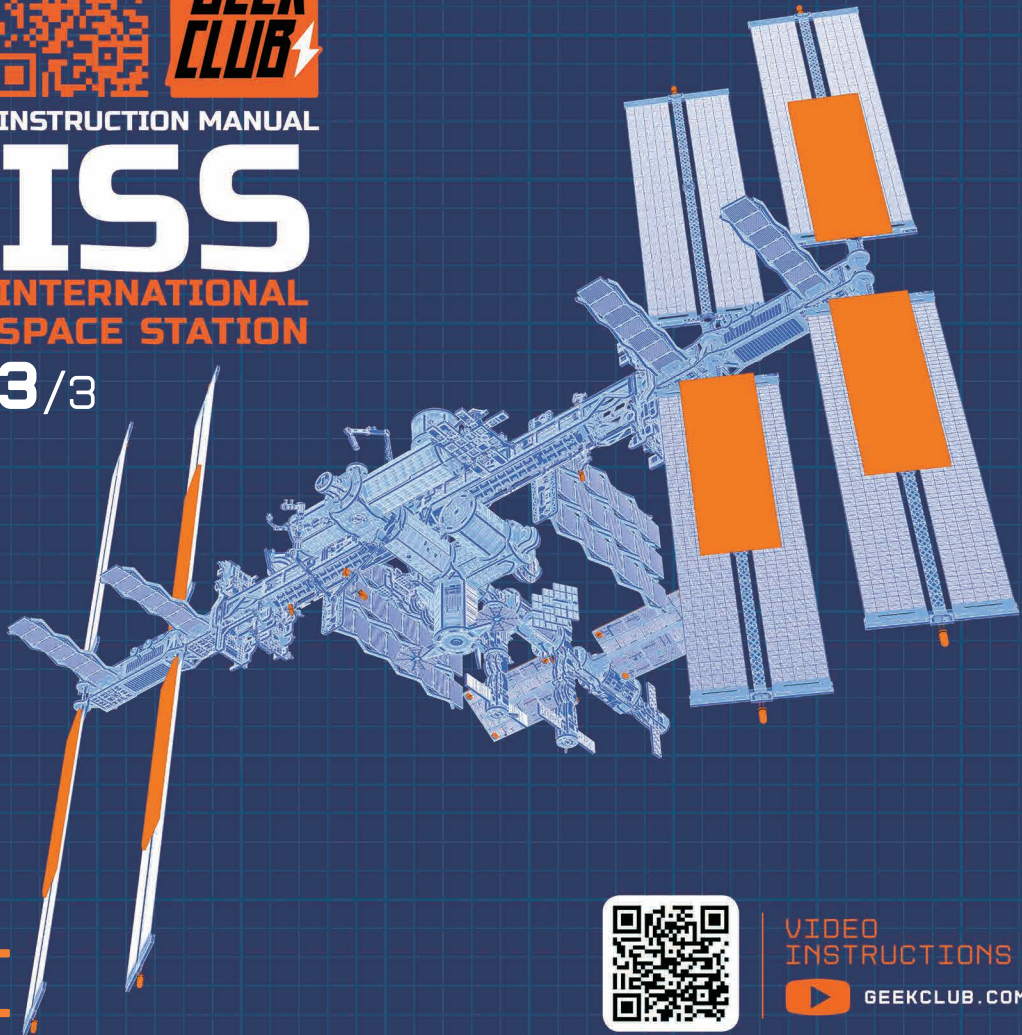

READ BEFORE FLIGHT



VIDEO
INSTRUCTIONS



GEEKCLUB.COM



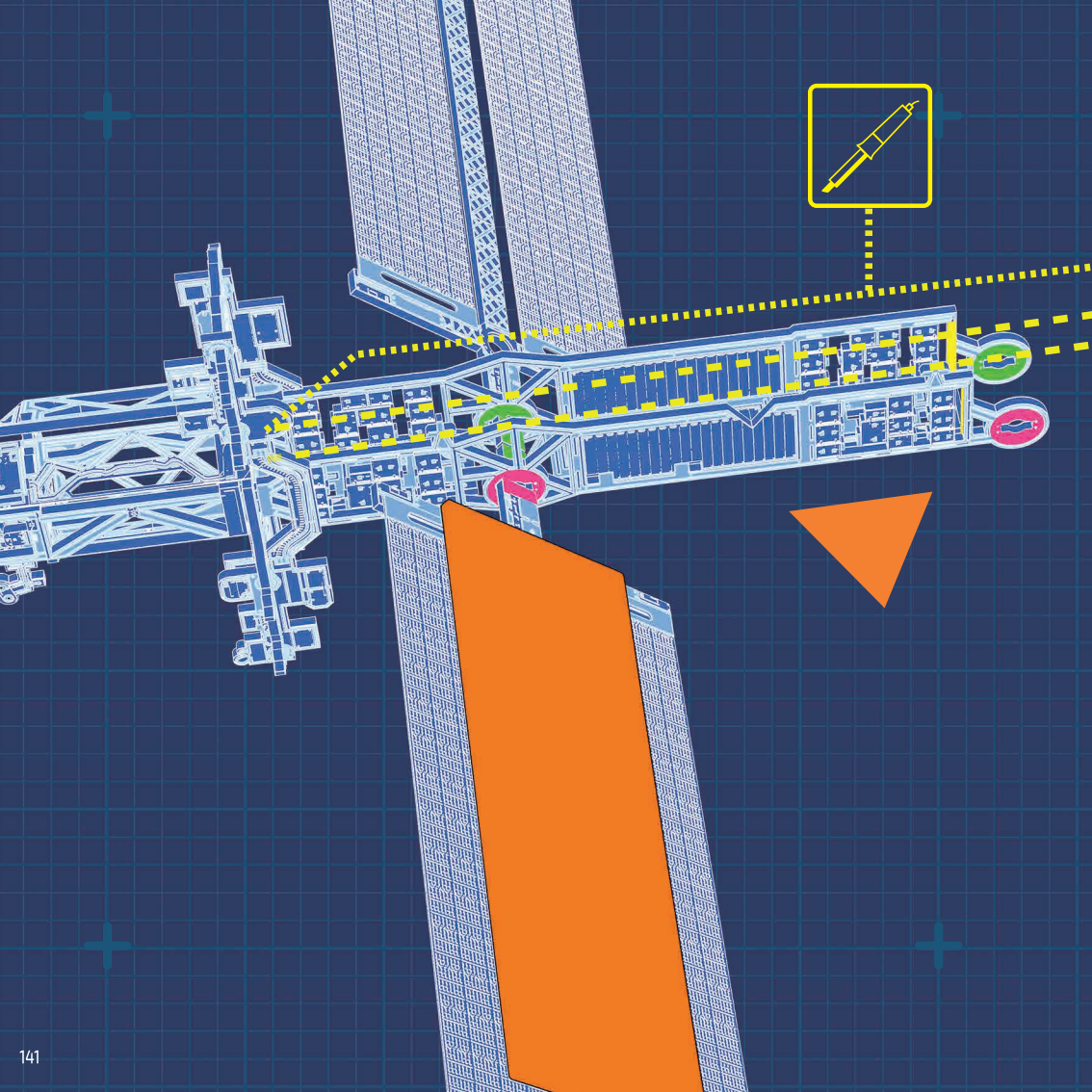

MORE INFO NEXT PAGE

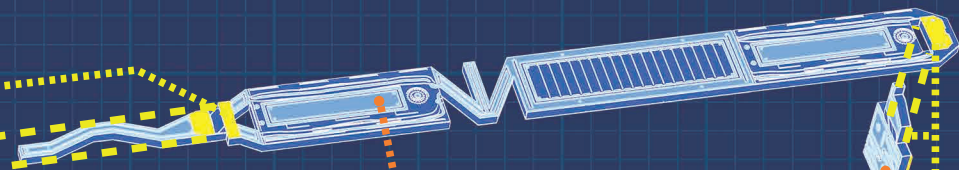

B1.7

B1.5

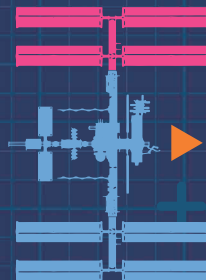

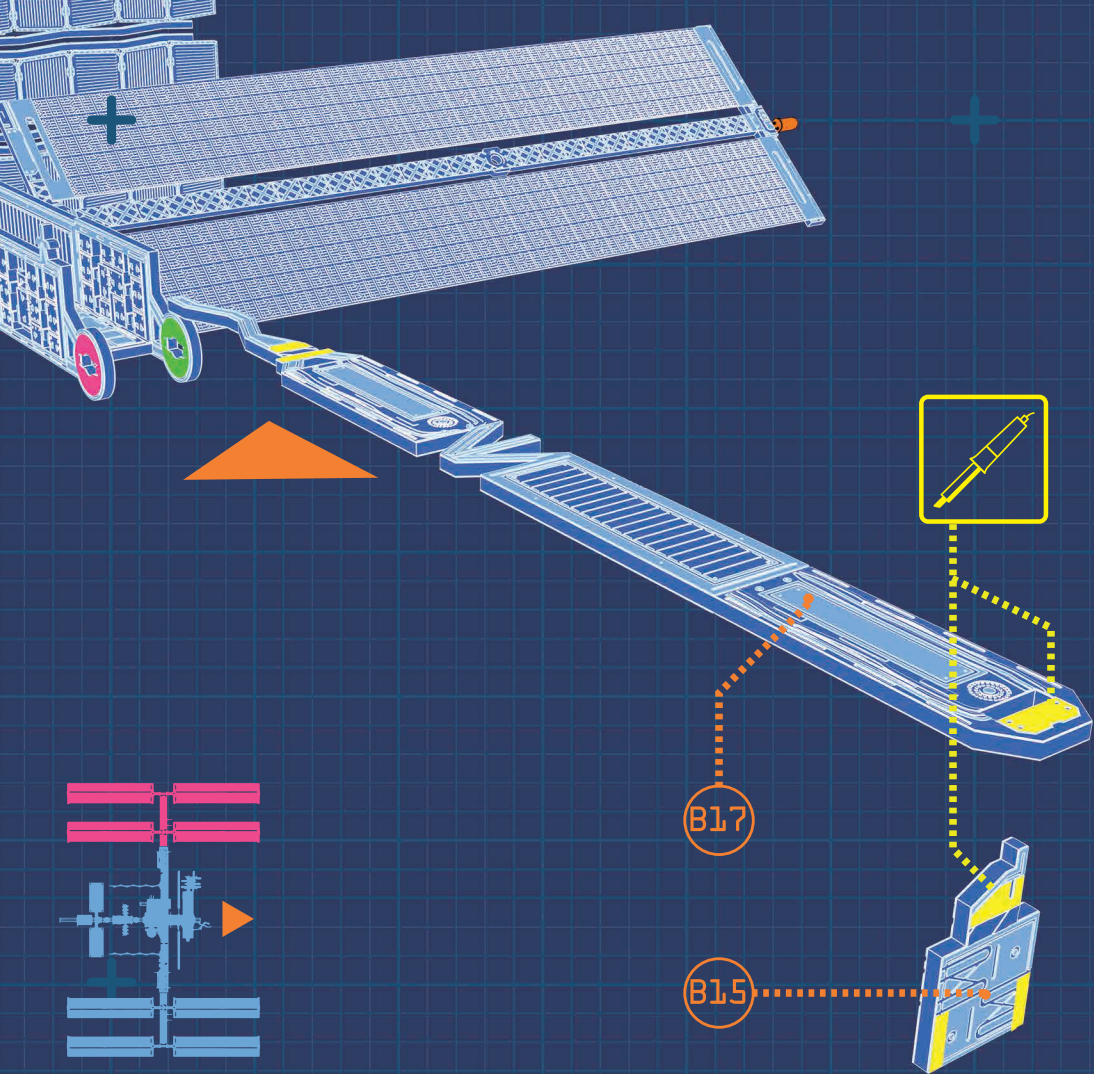

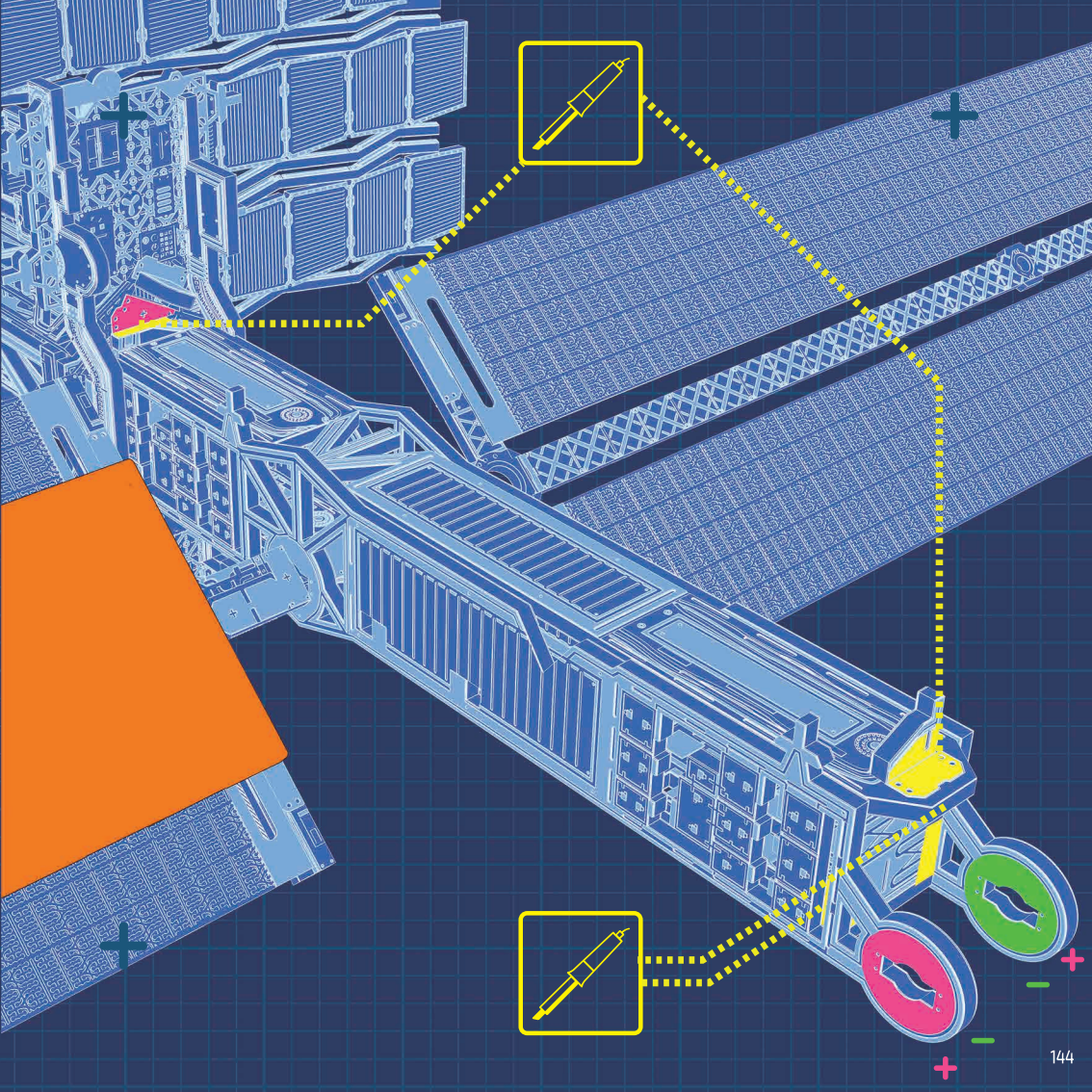

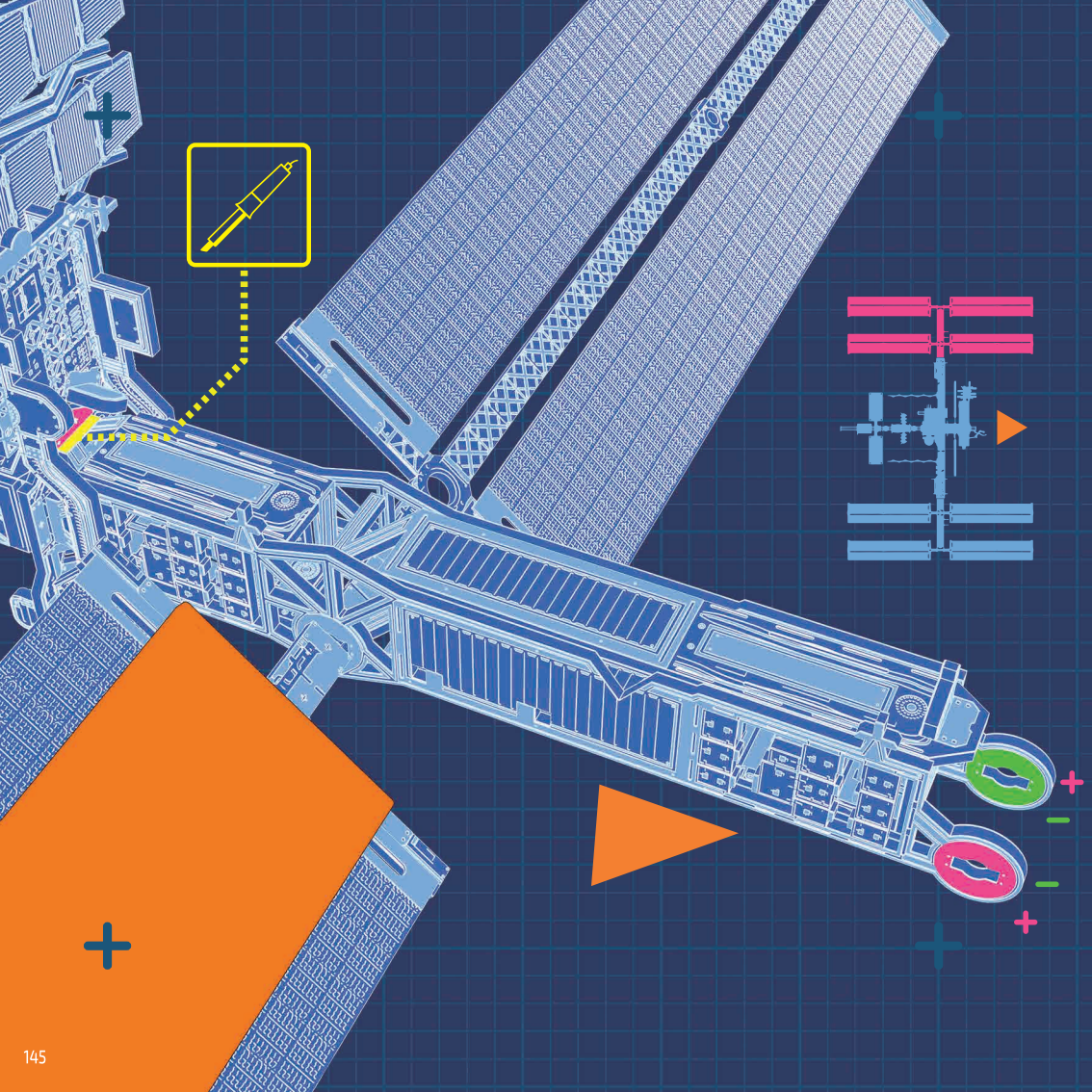

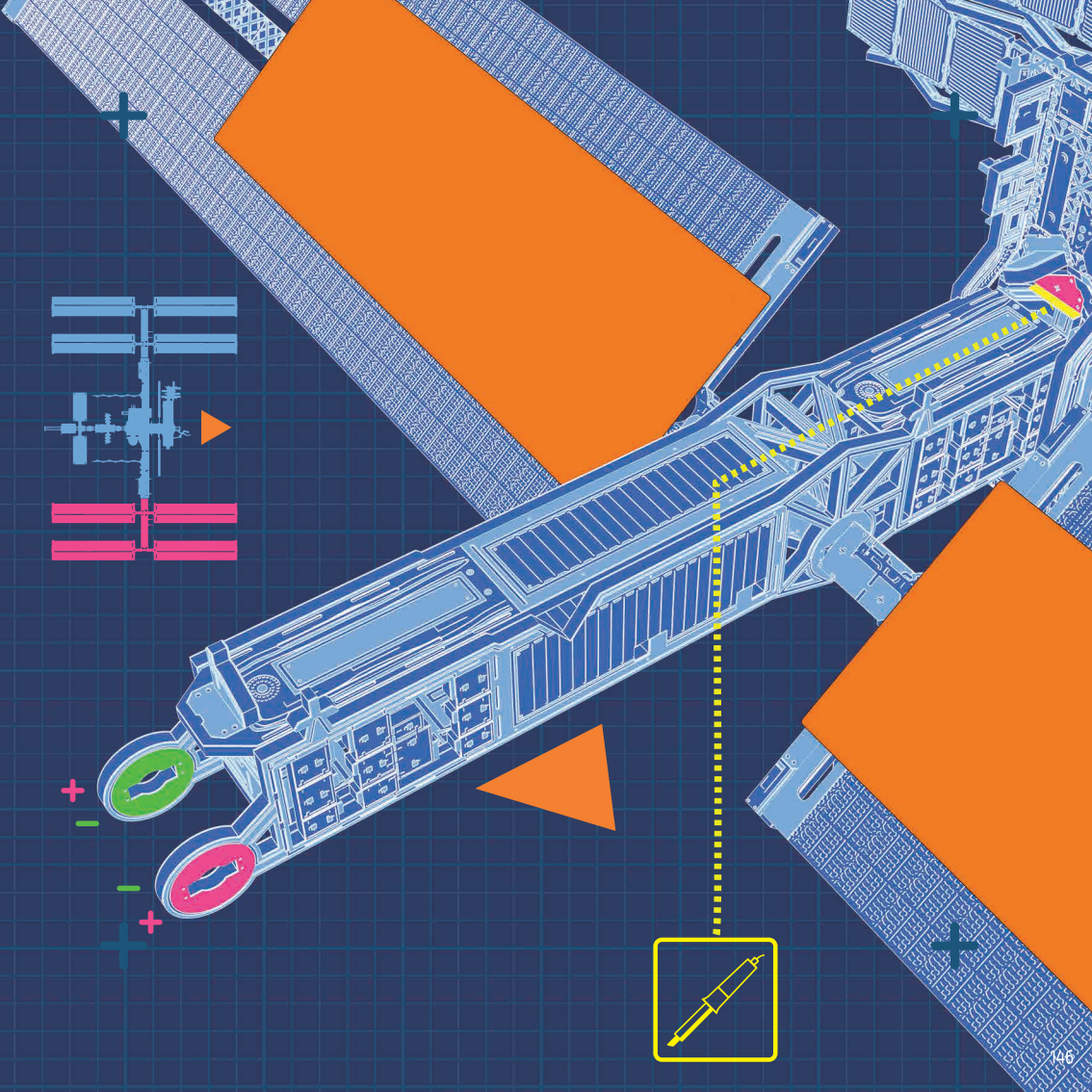

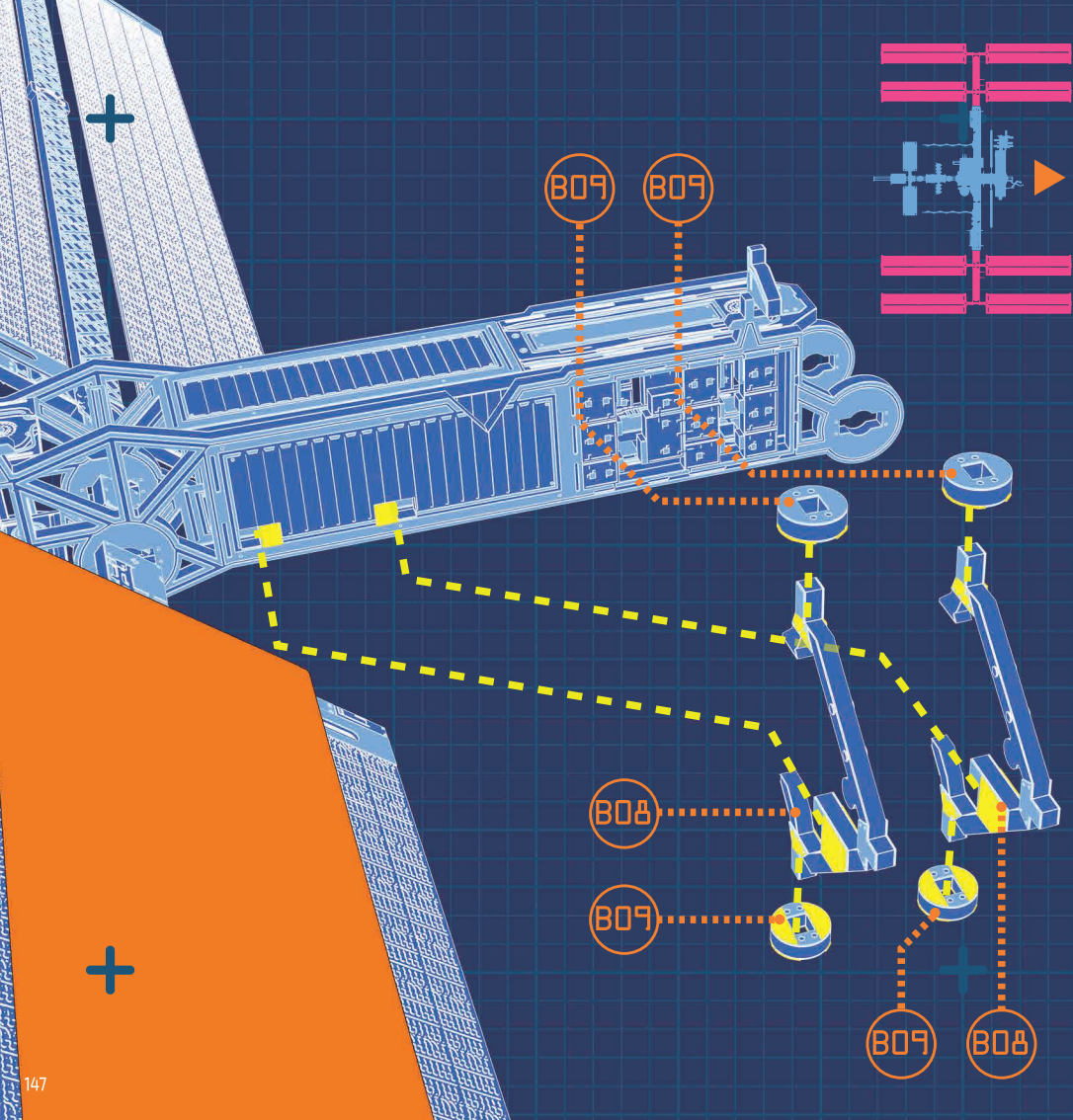

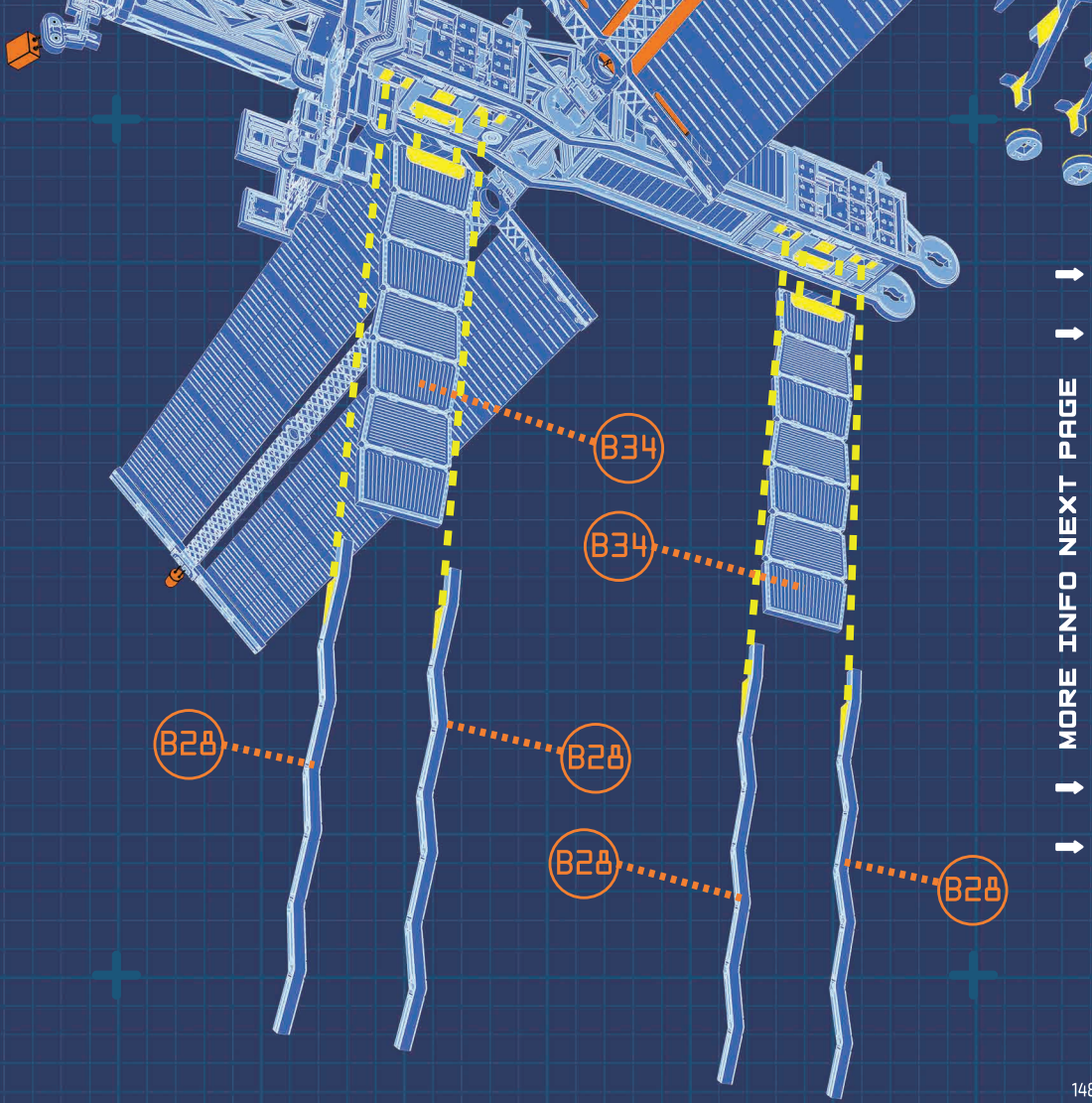

↑ MORE INFO NEXT PAGE ↑

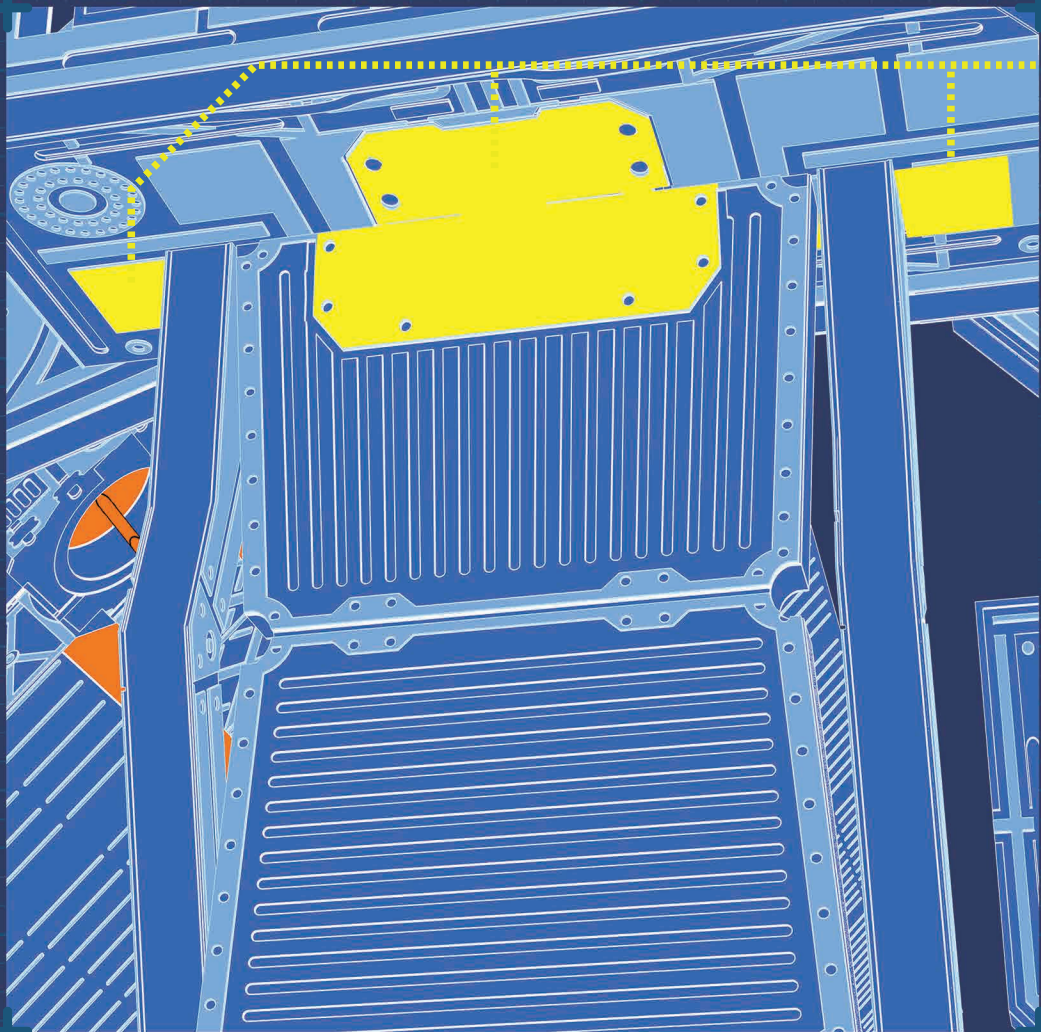



MORE INFO NEXT PAGE

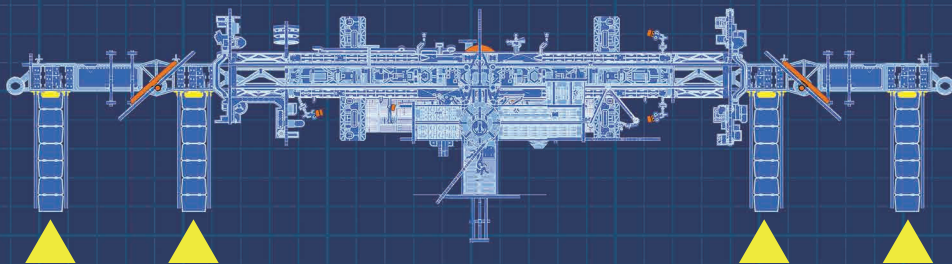

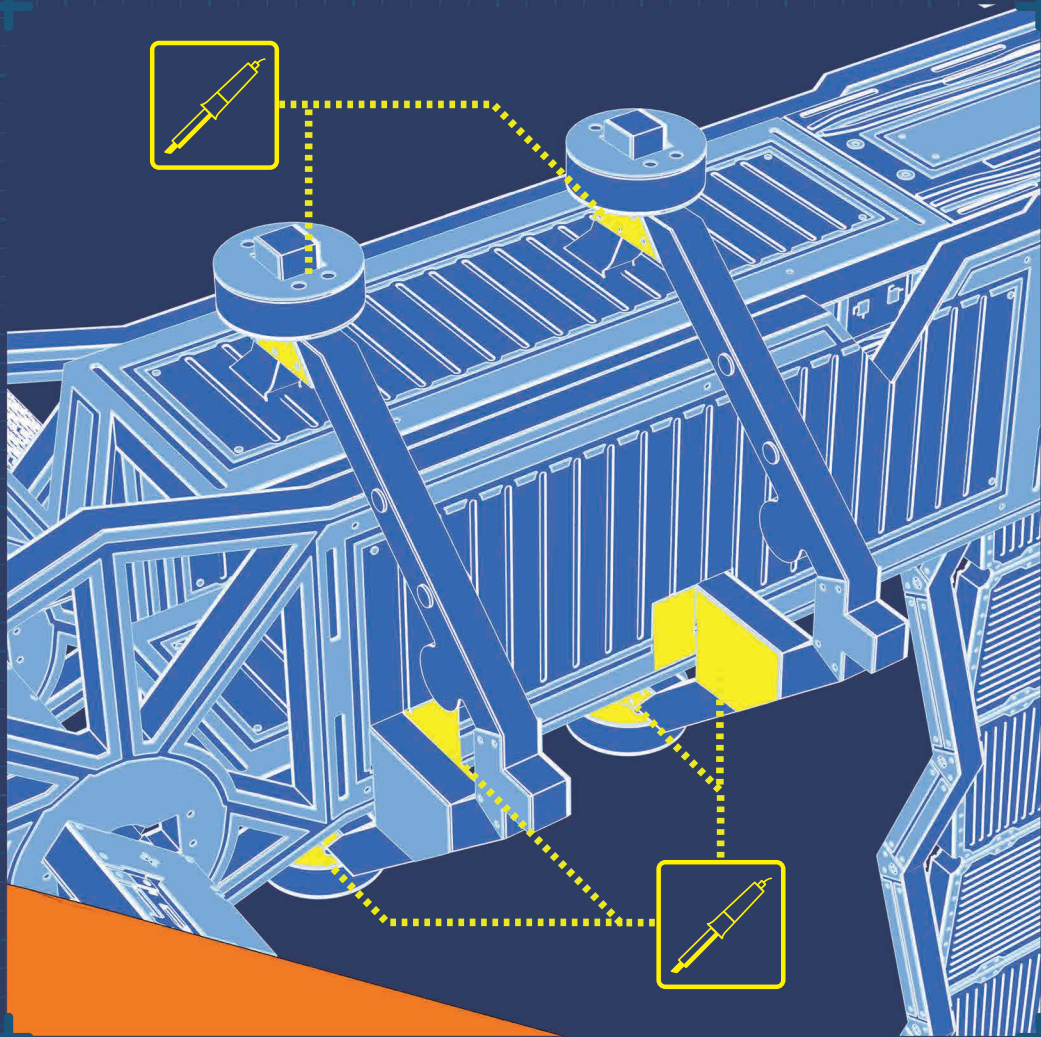

MORE INFO NEXT PAGE

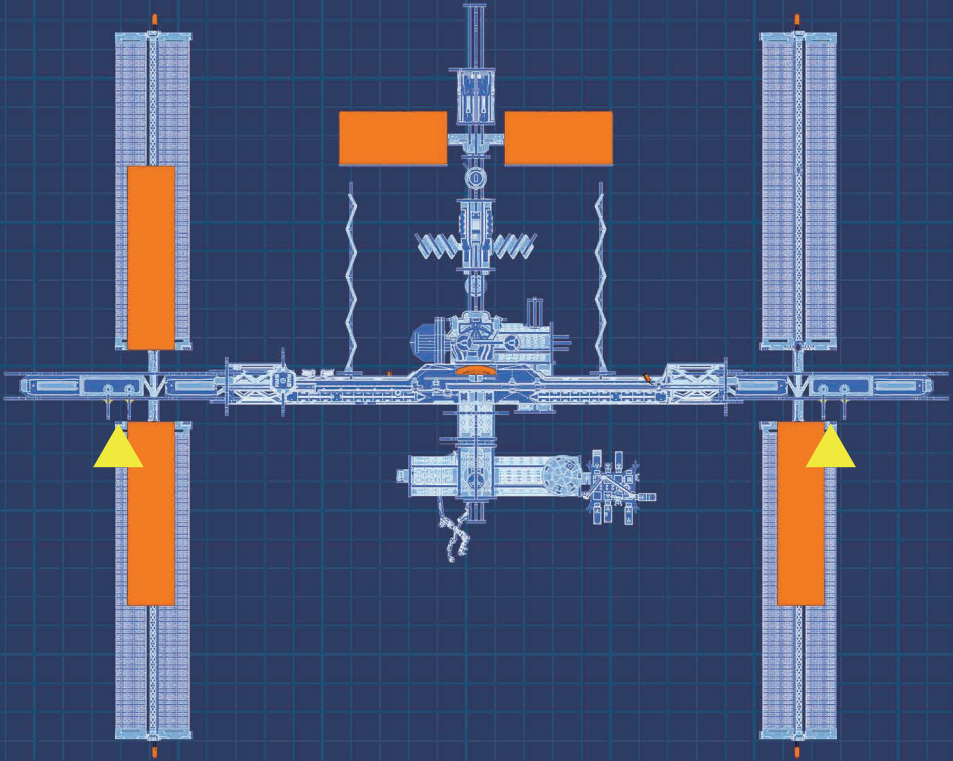

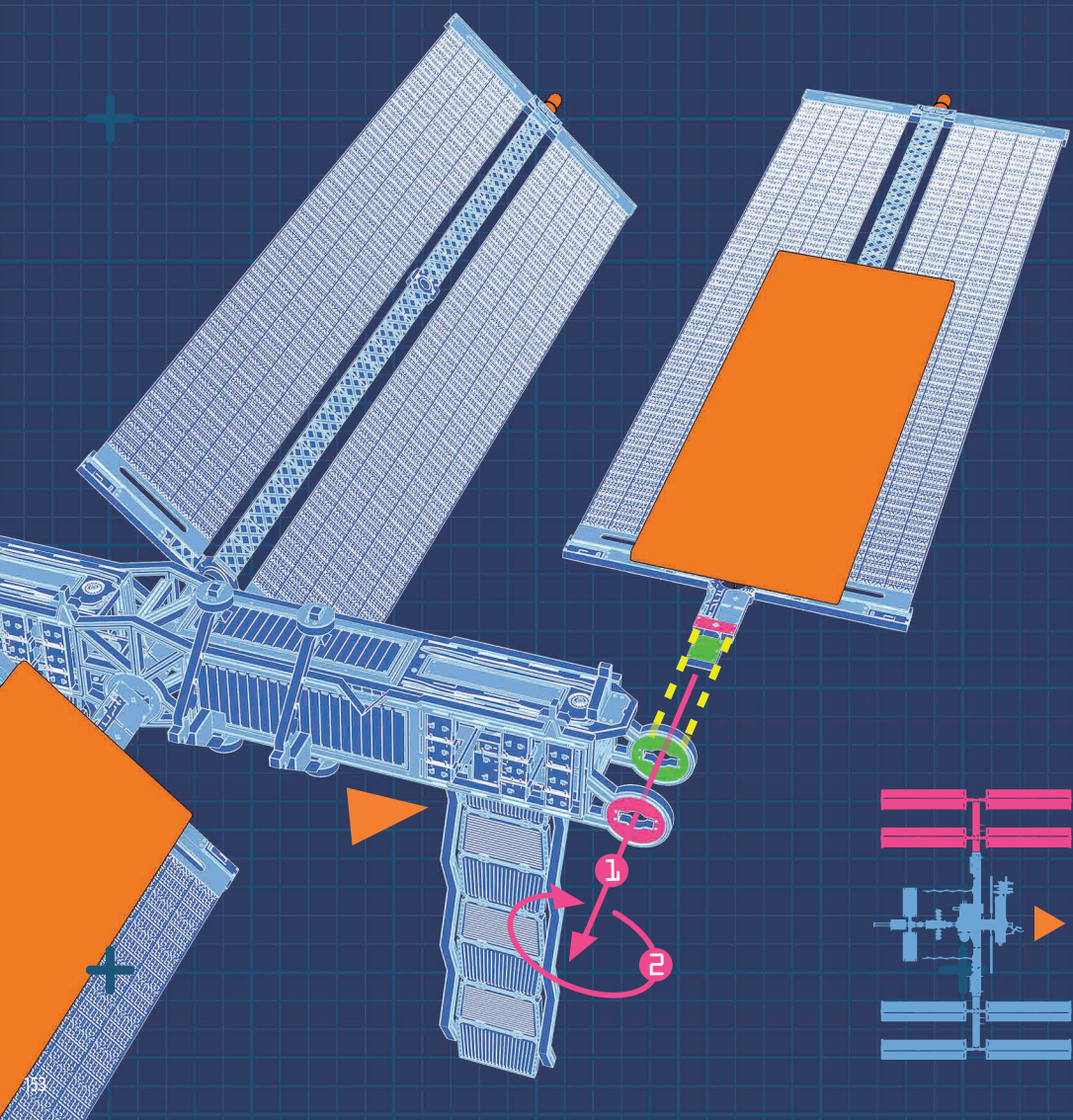

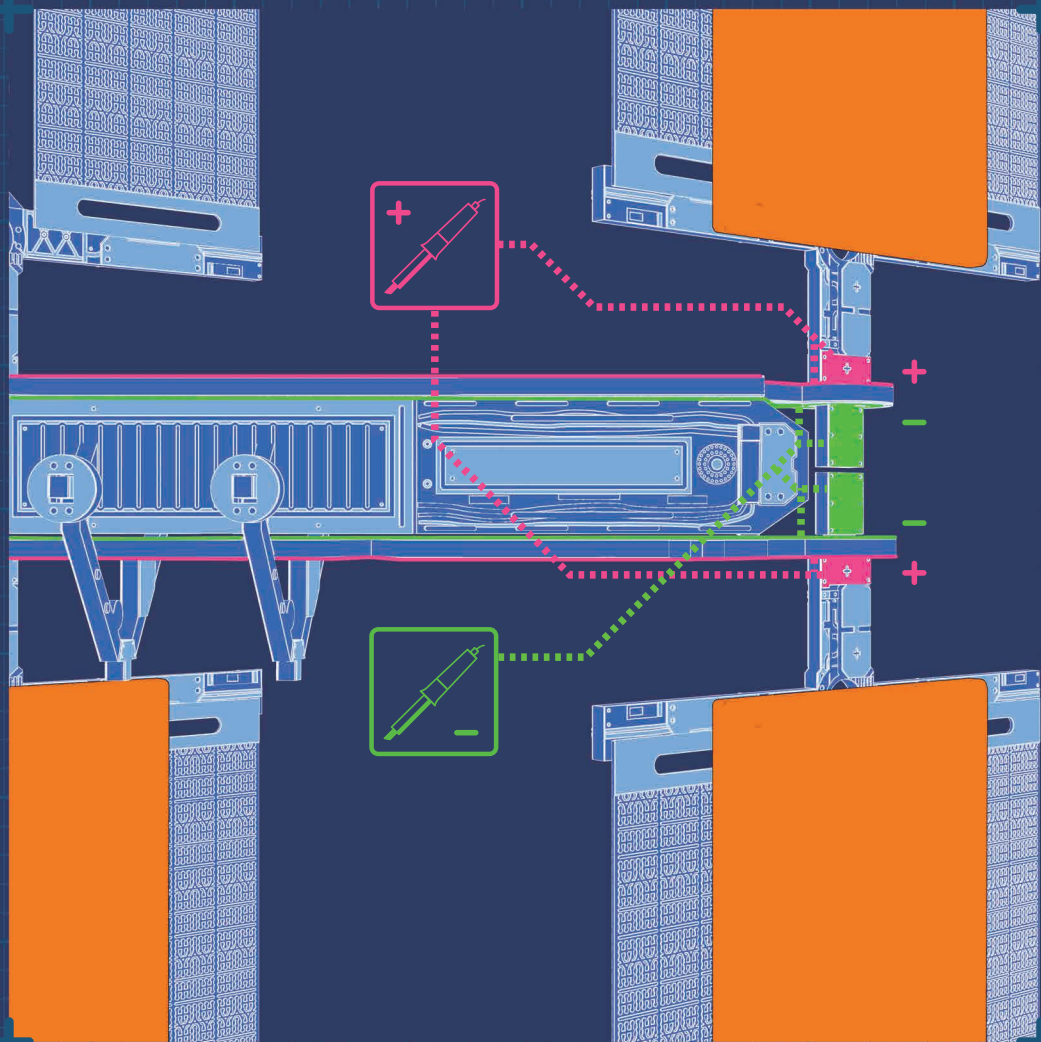

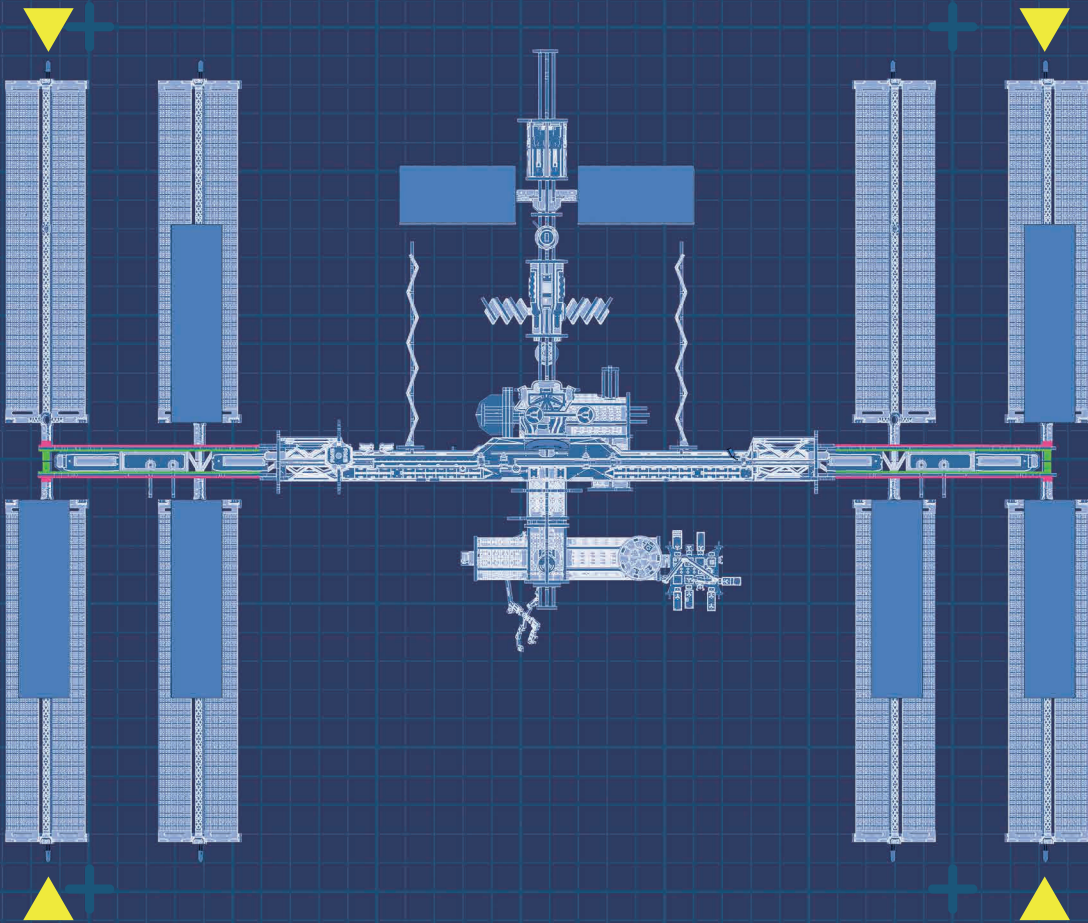

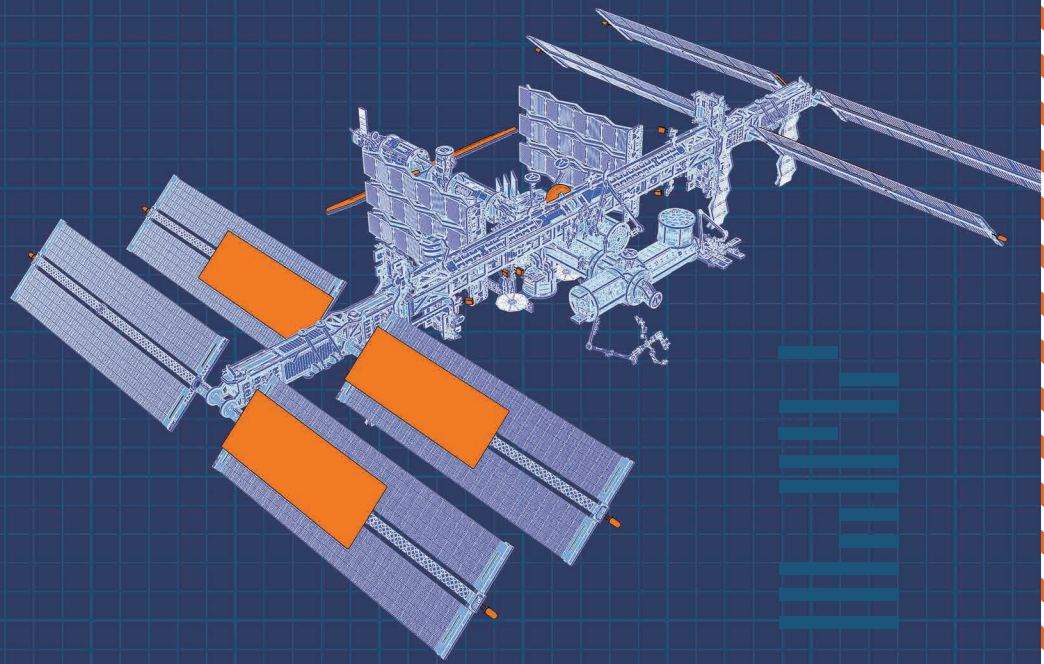

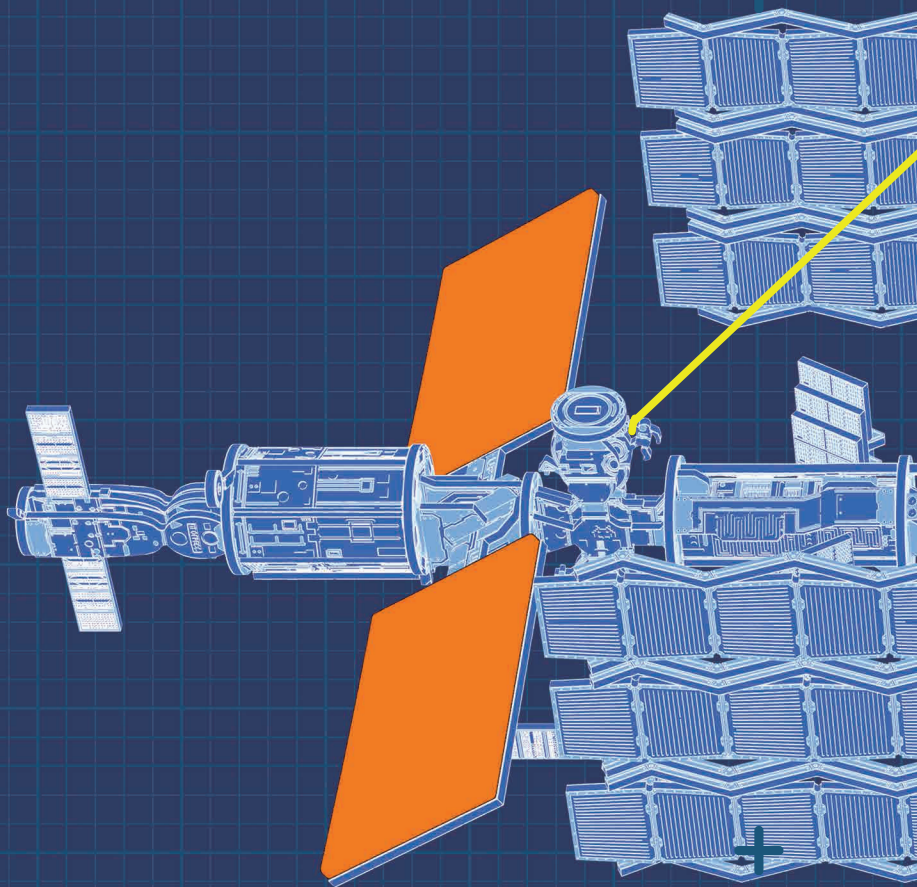

NYLON WIRE

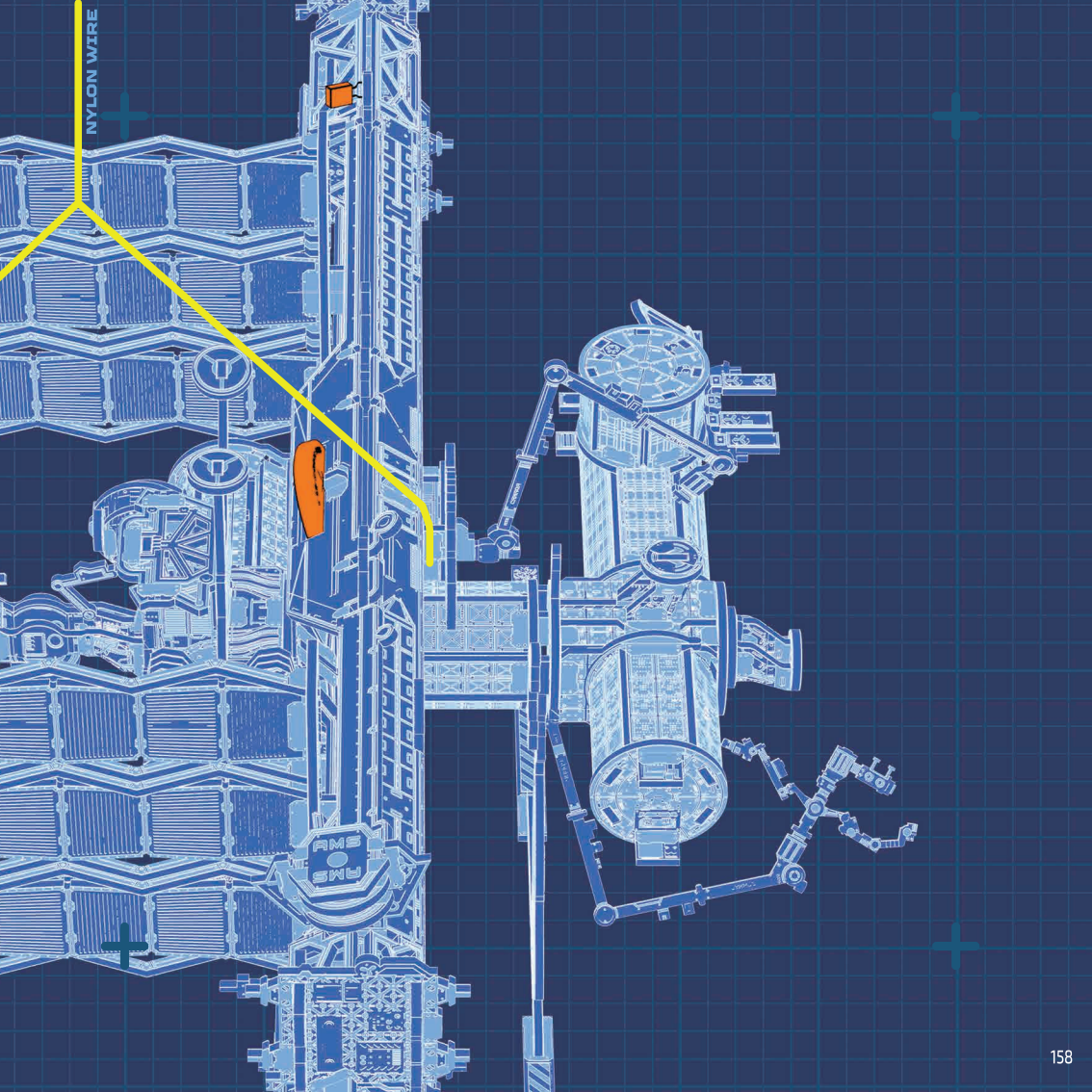

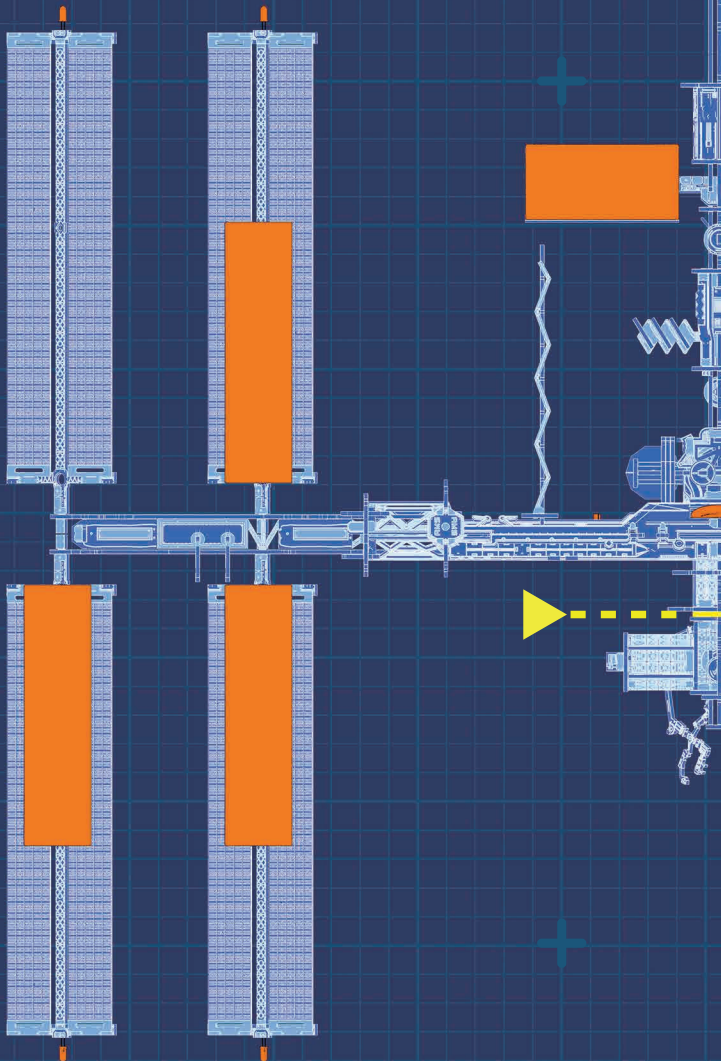

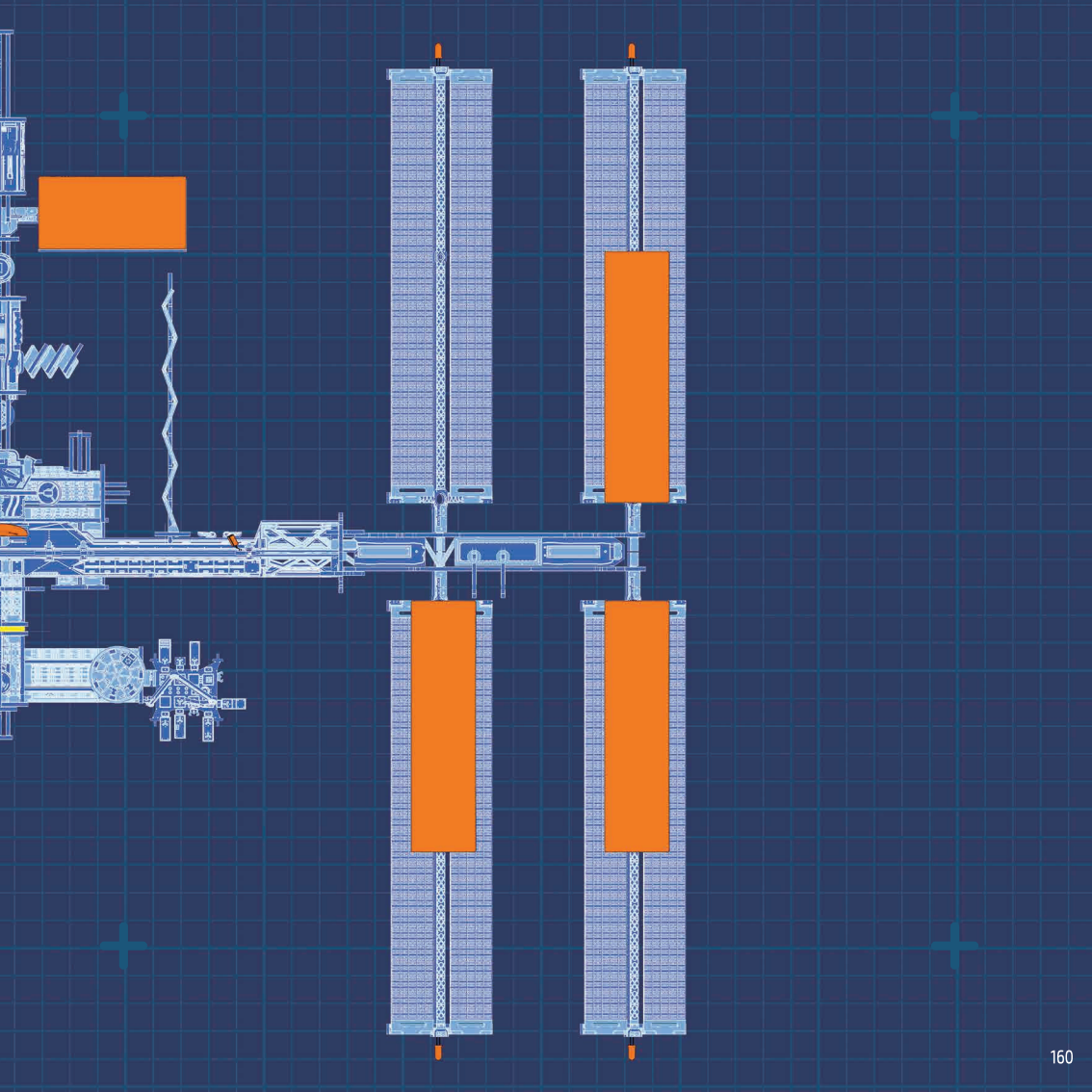

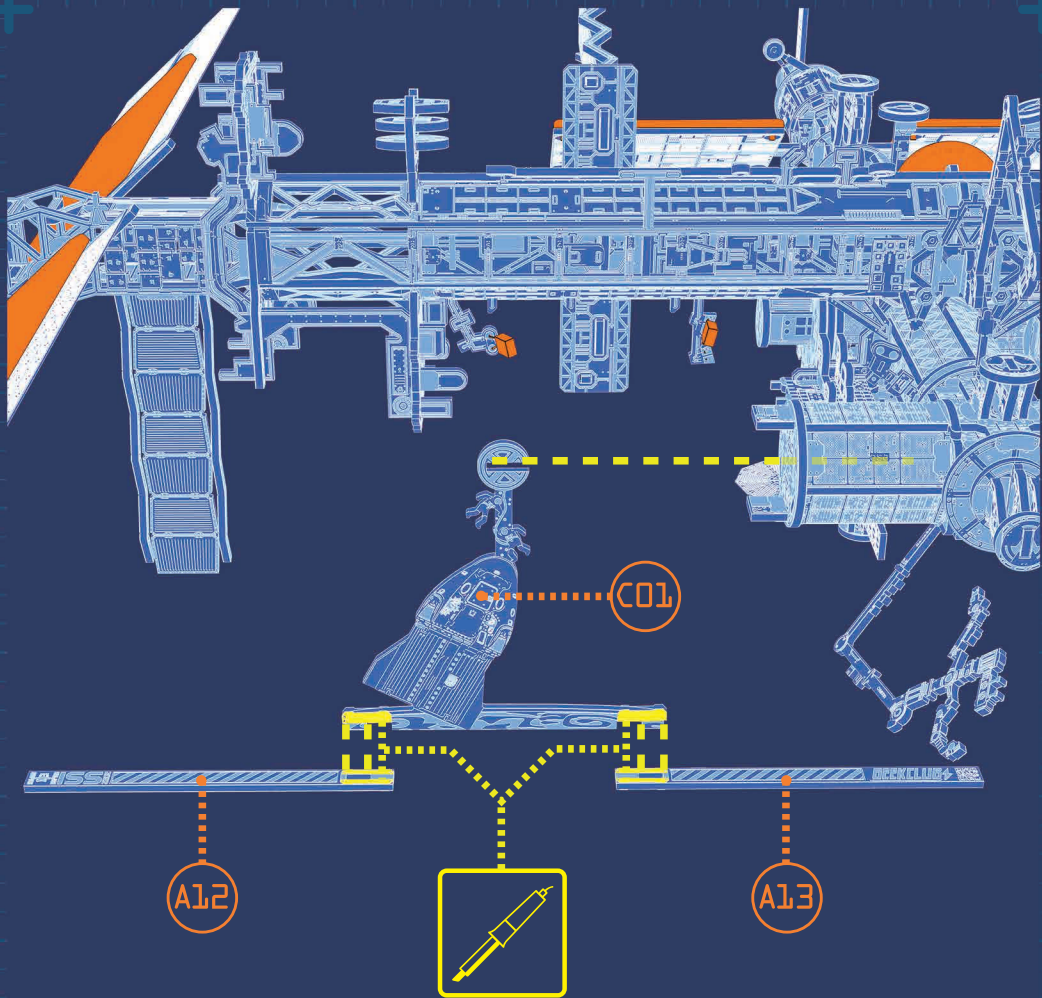

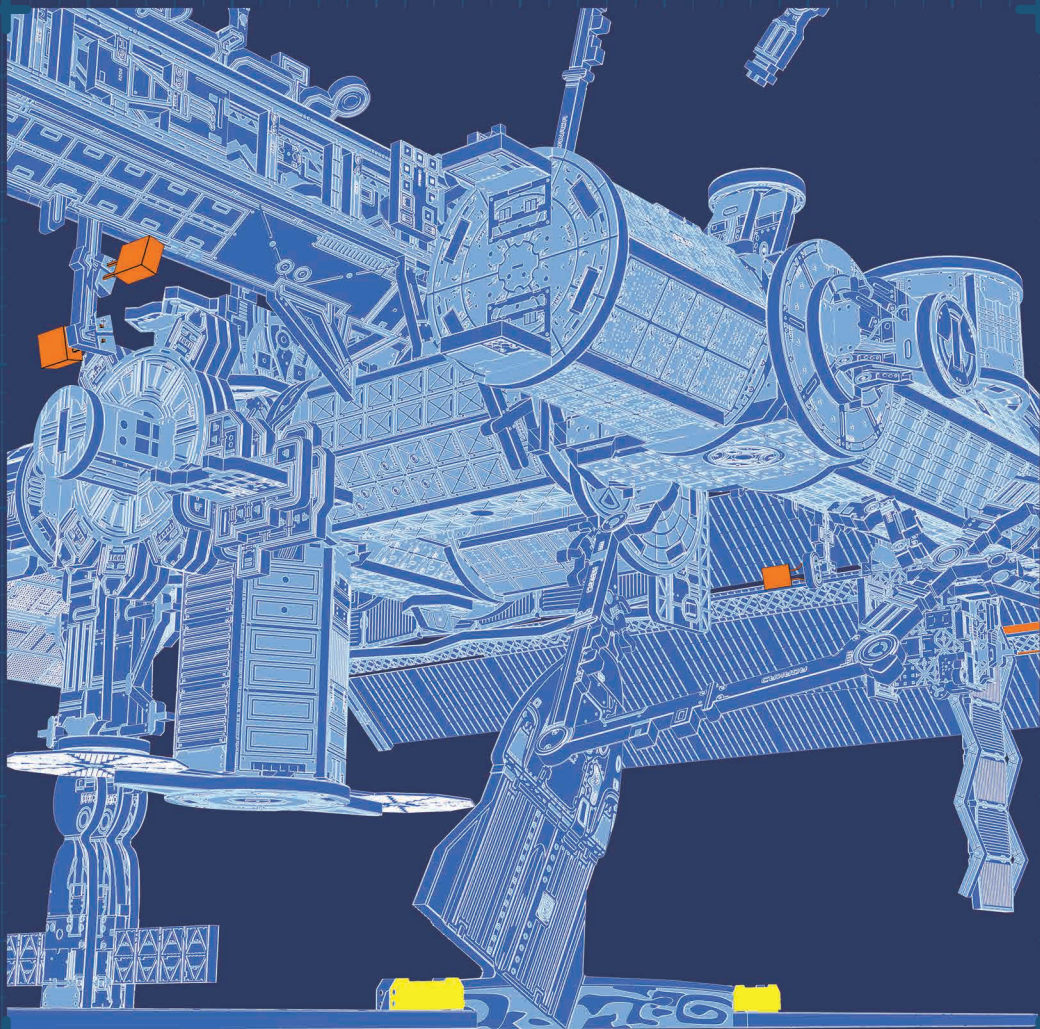

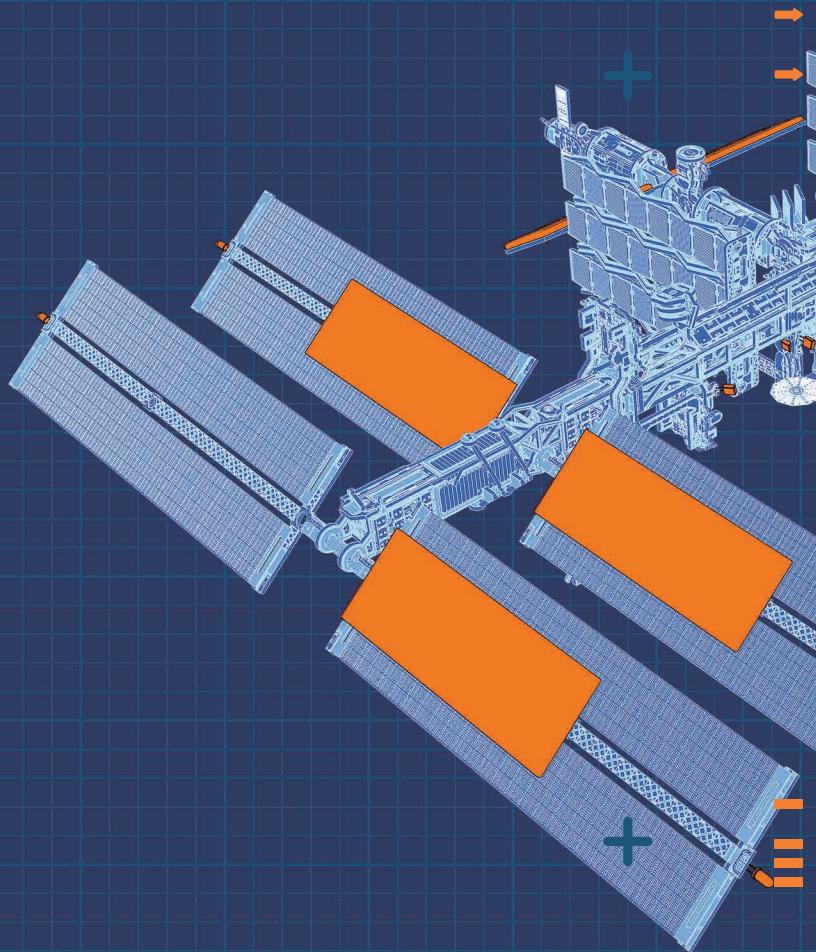

▶ KEEP SAFE

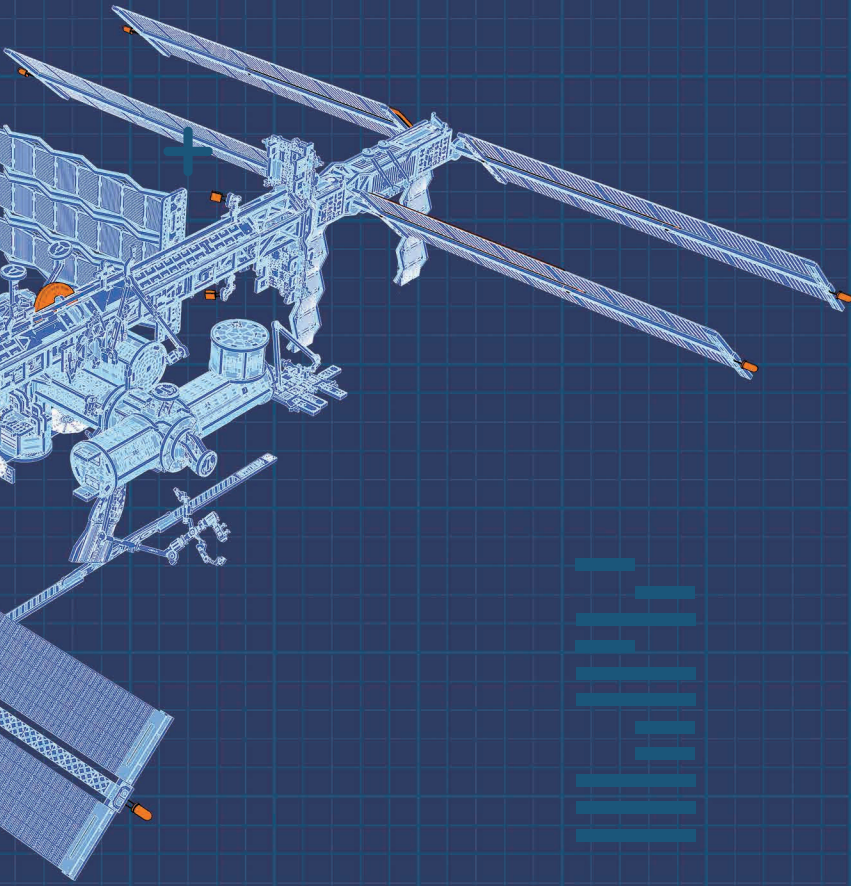

▶ KEEP SAFE

LIFT OFF

LIFT OFF

KEEP SAFE

WORLD

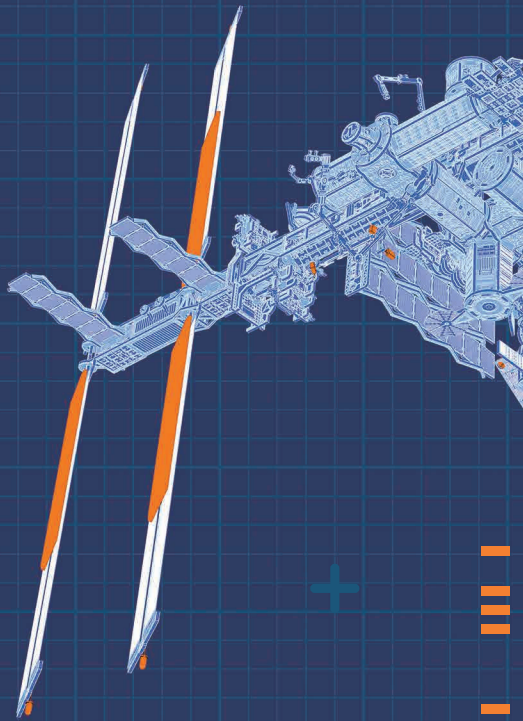

KEEP SAFE

KEEP SAFE ▶

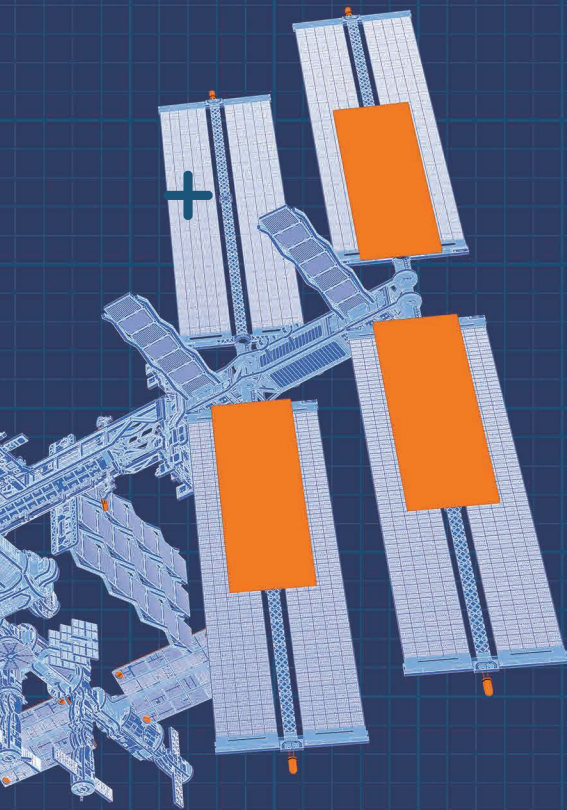

LIFT OFF

KEEP SAFE ▶

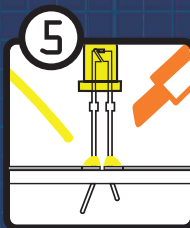
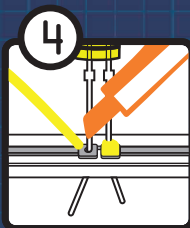
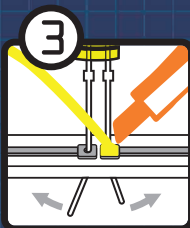
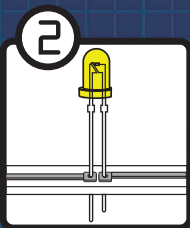
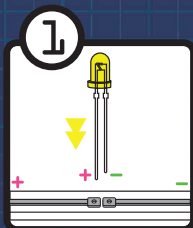
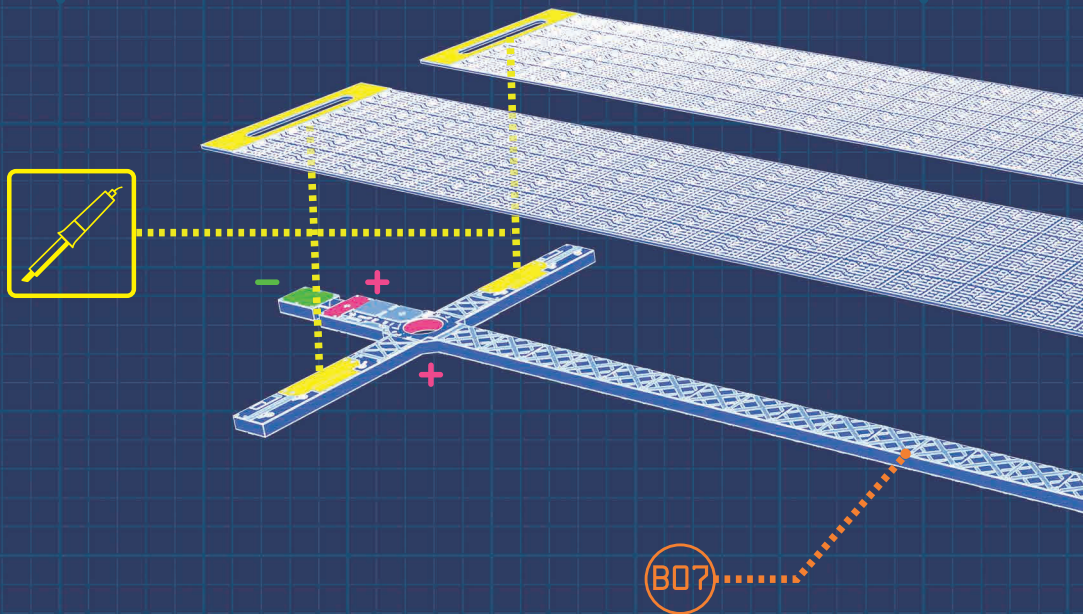

X8

B01

B01



x8

LED TH 3mm
Through-Hole

RED BLINKING

SCHEMATIC
IMAGE



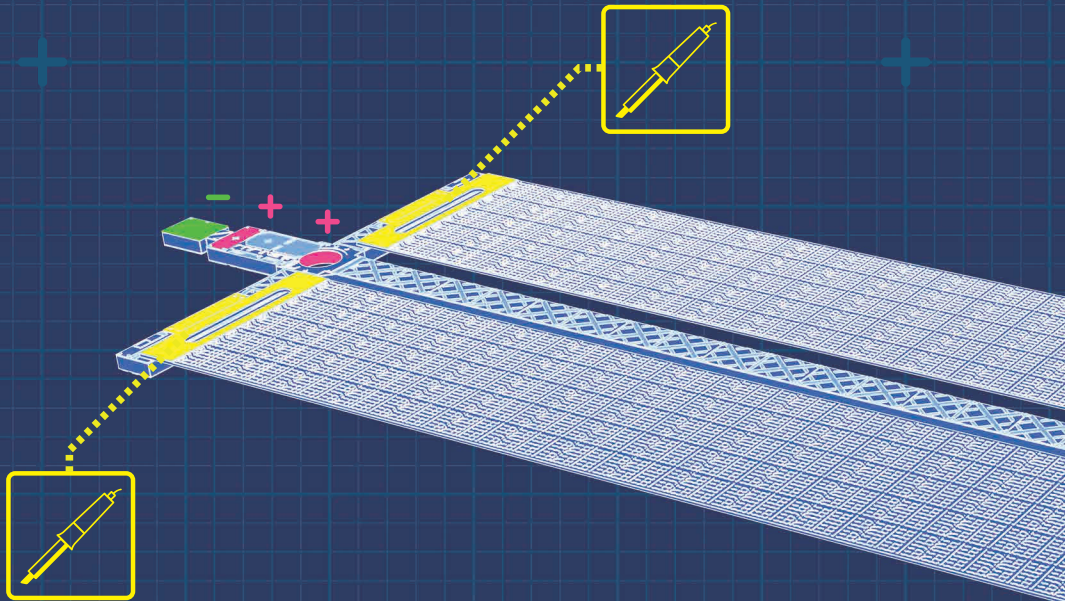

MORE INFO NEXT PAGE



X8

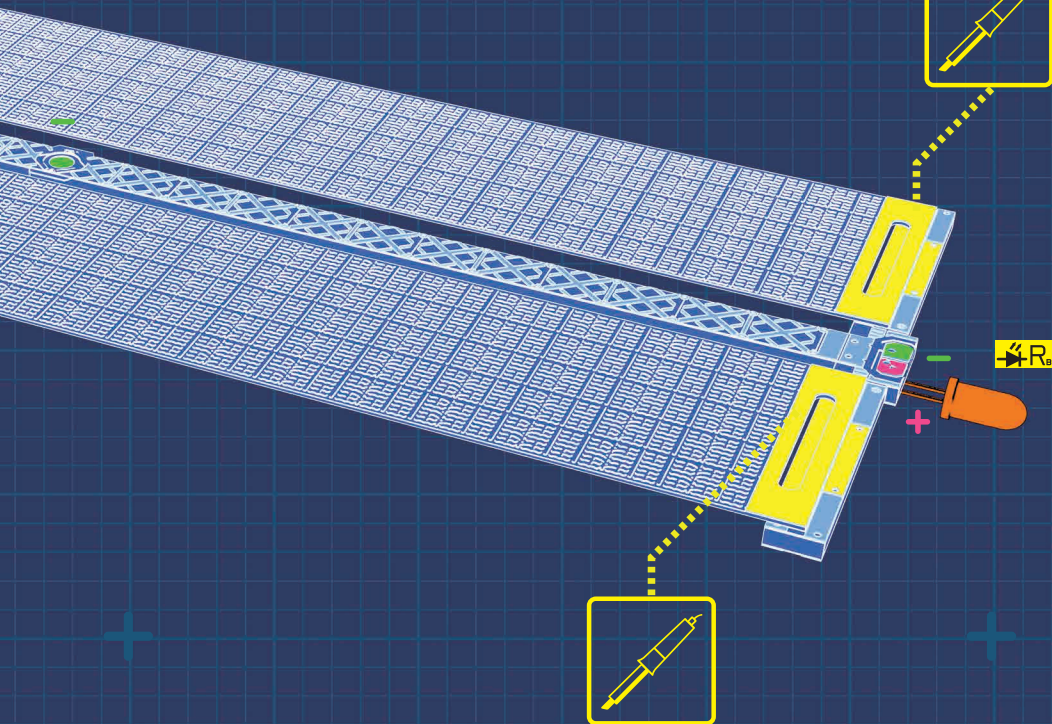



X6

OPTIONAL

B01

B01

B07

OPTIONAL

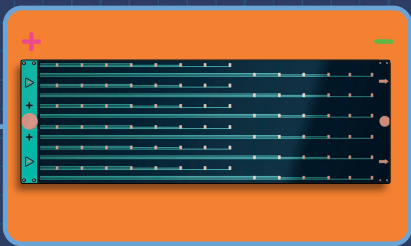
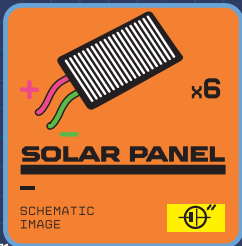

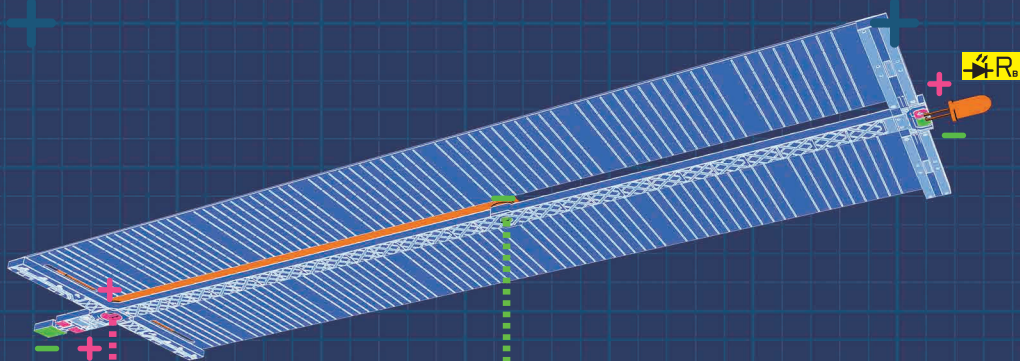

X6

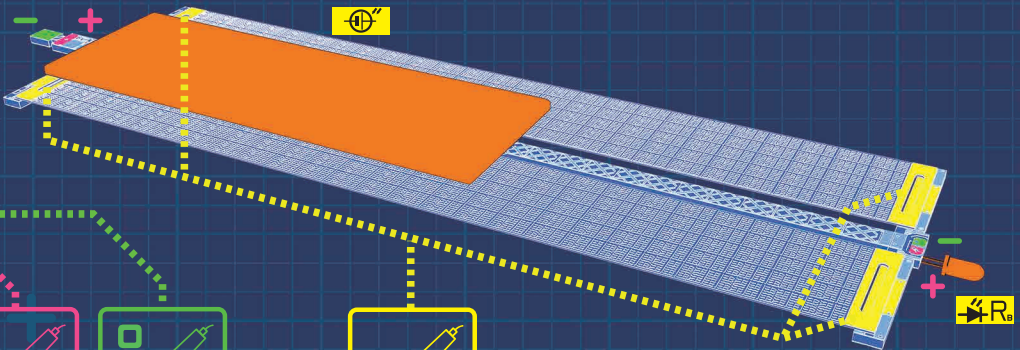

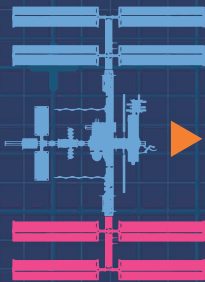

B20

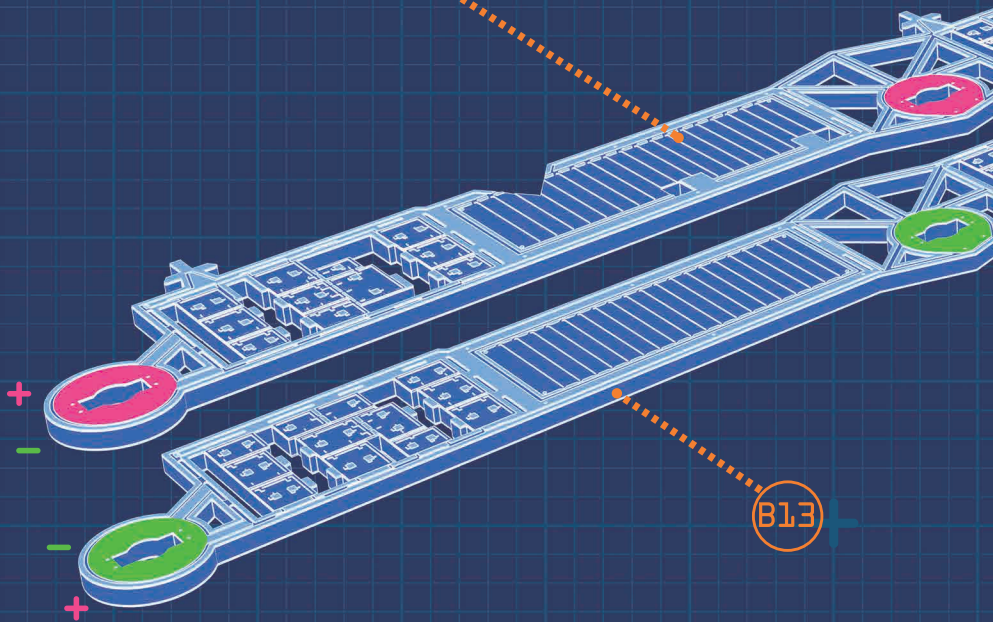

B13

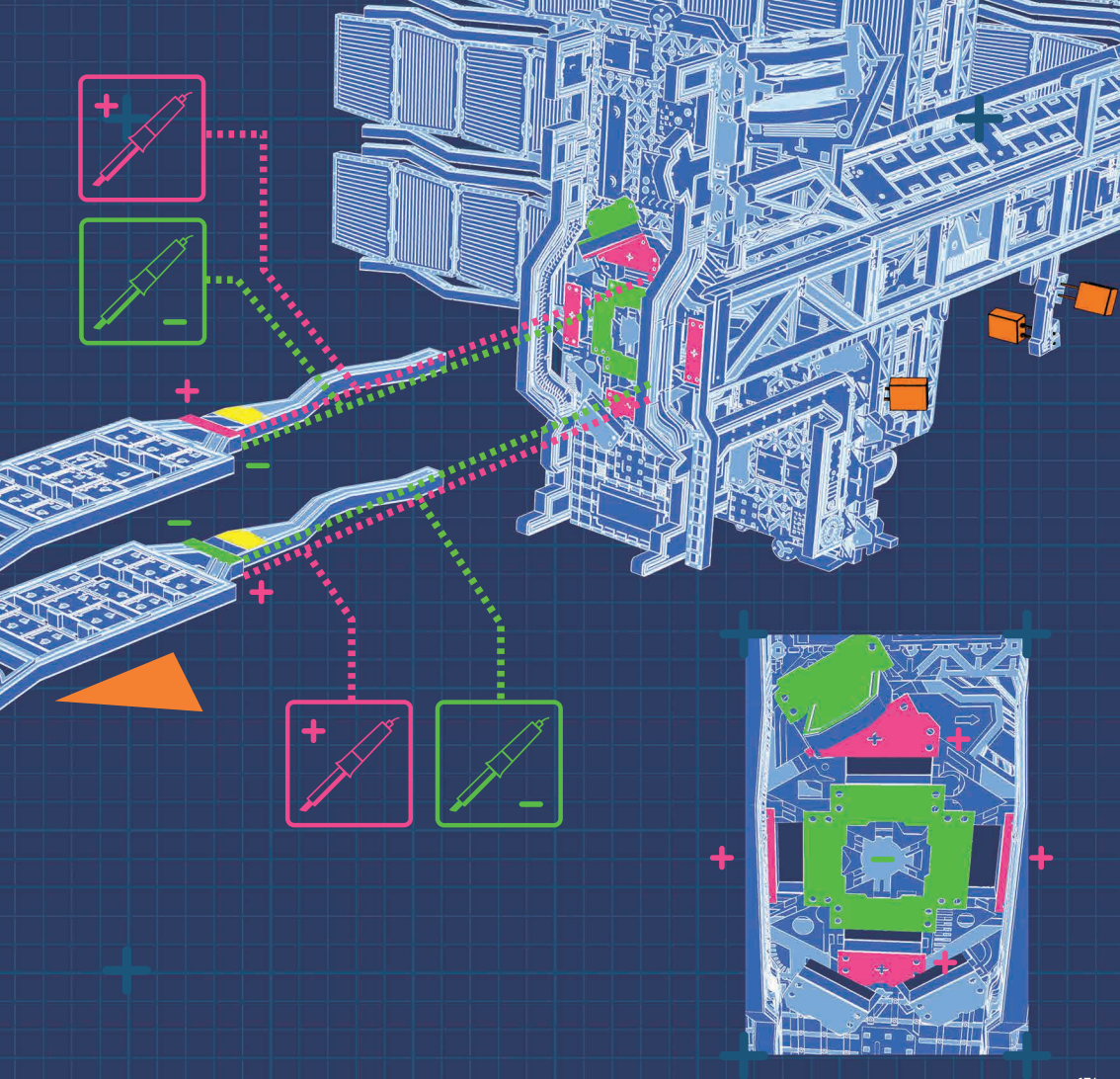

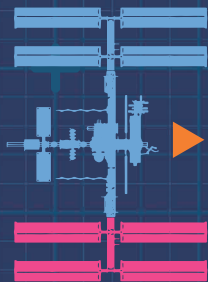

B16

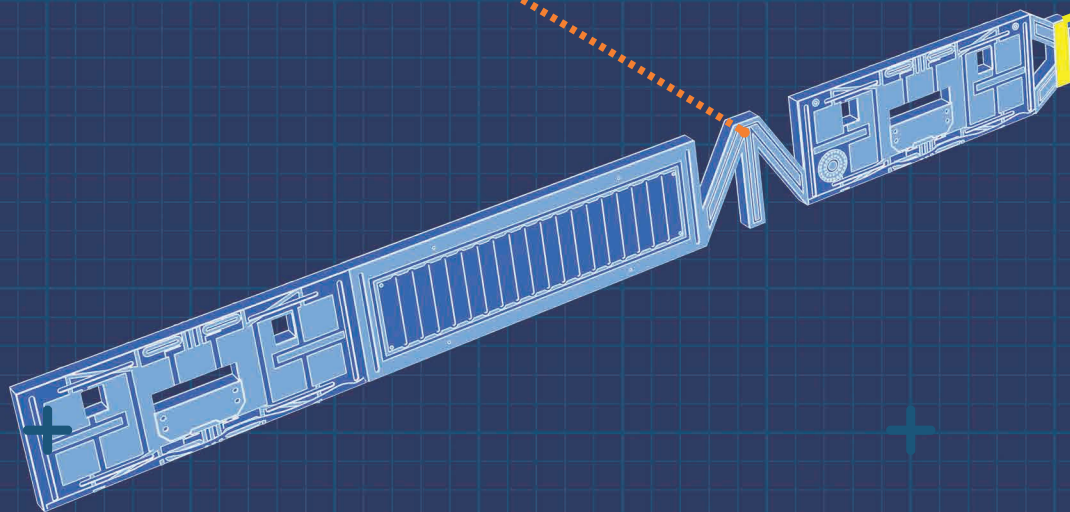

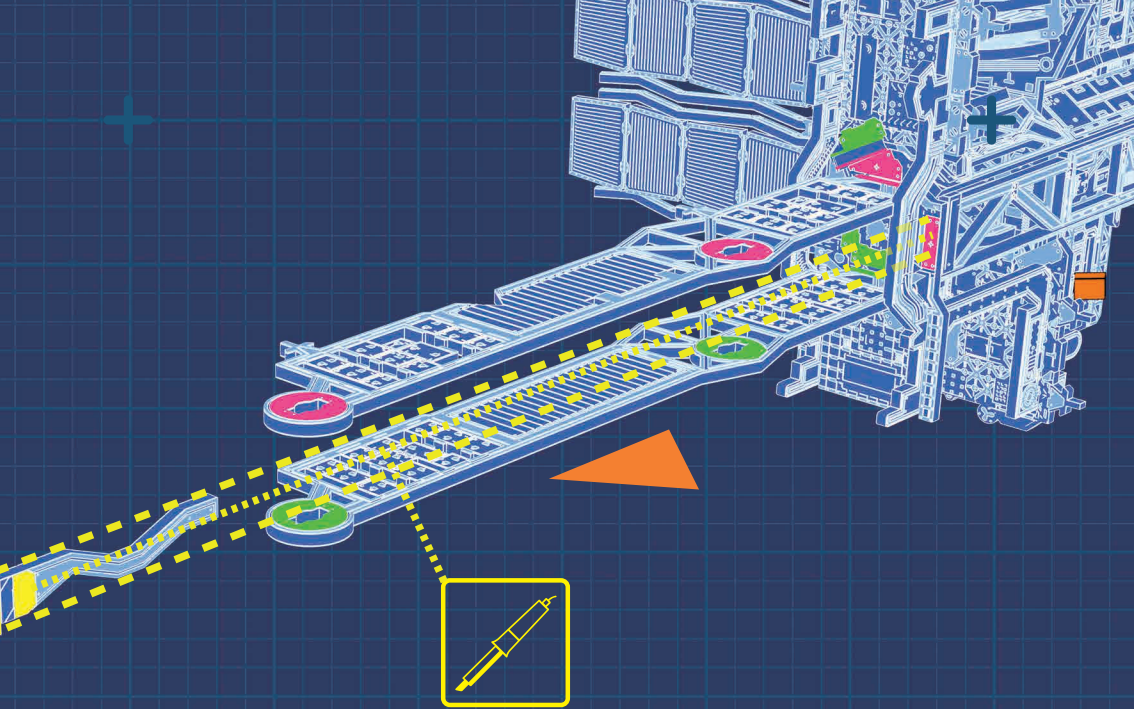

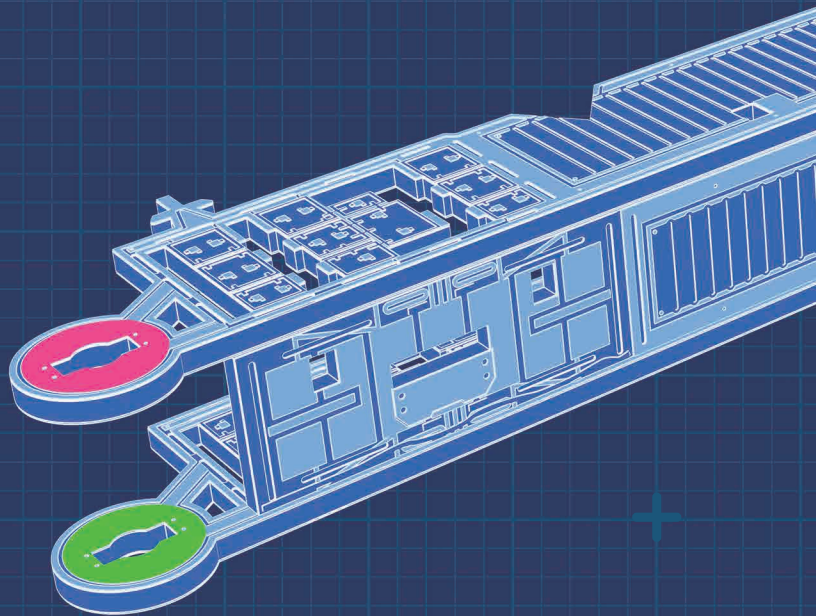

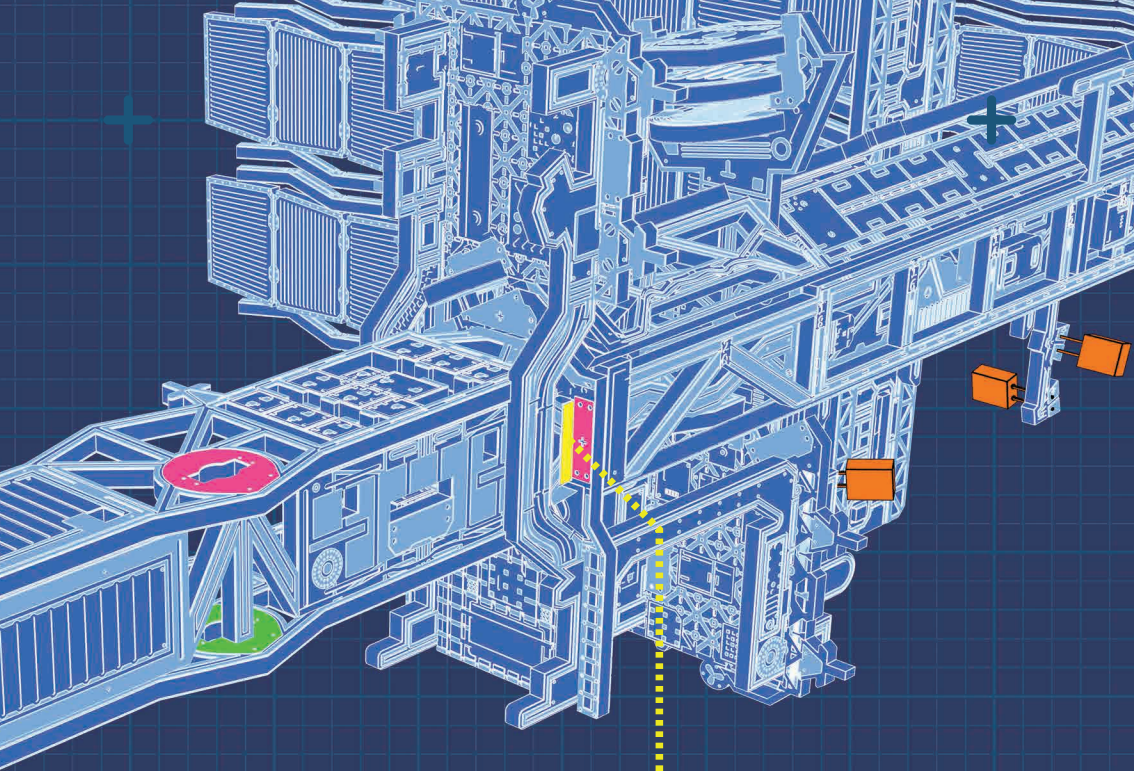

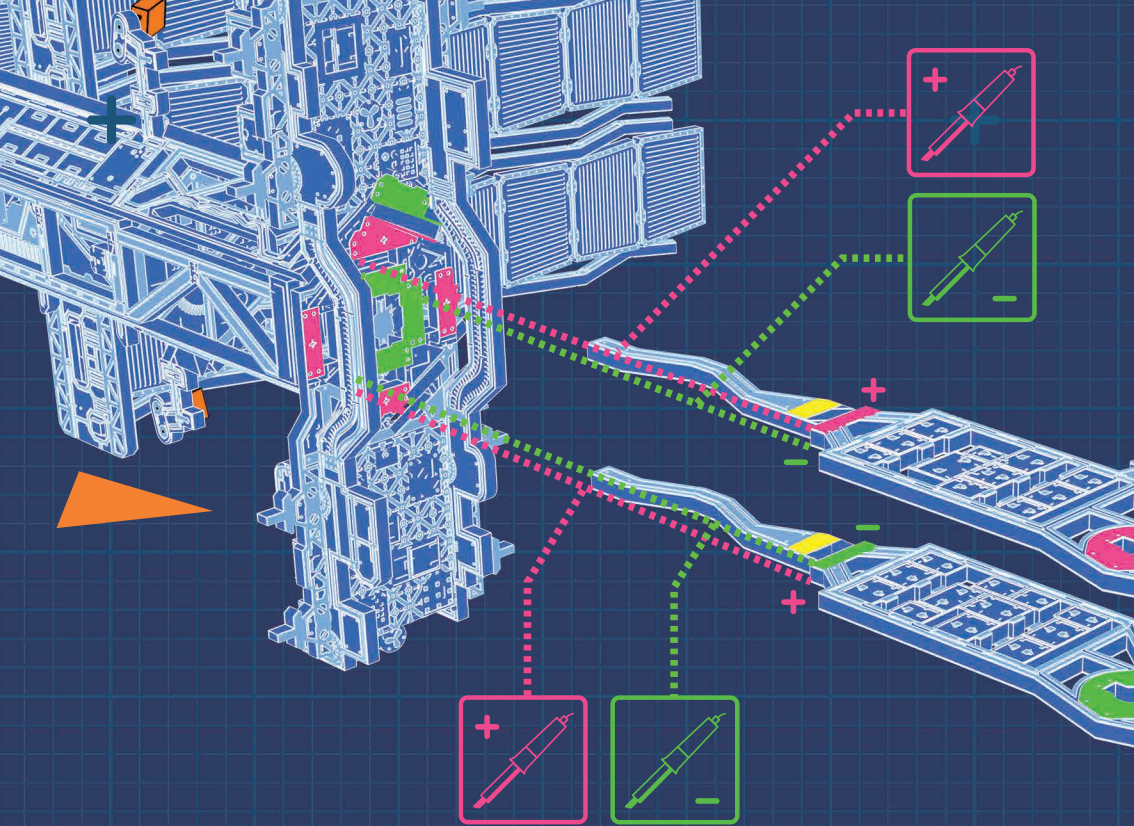

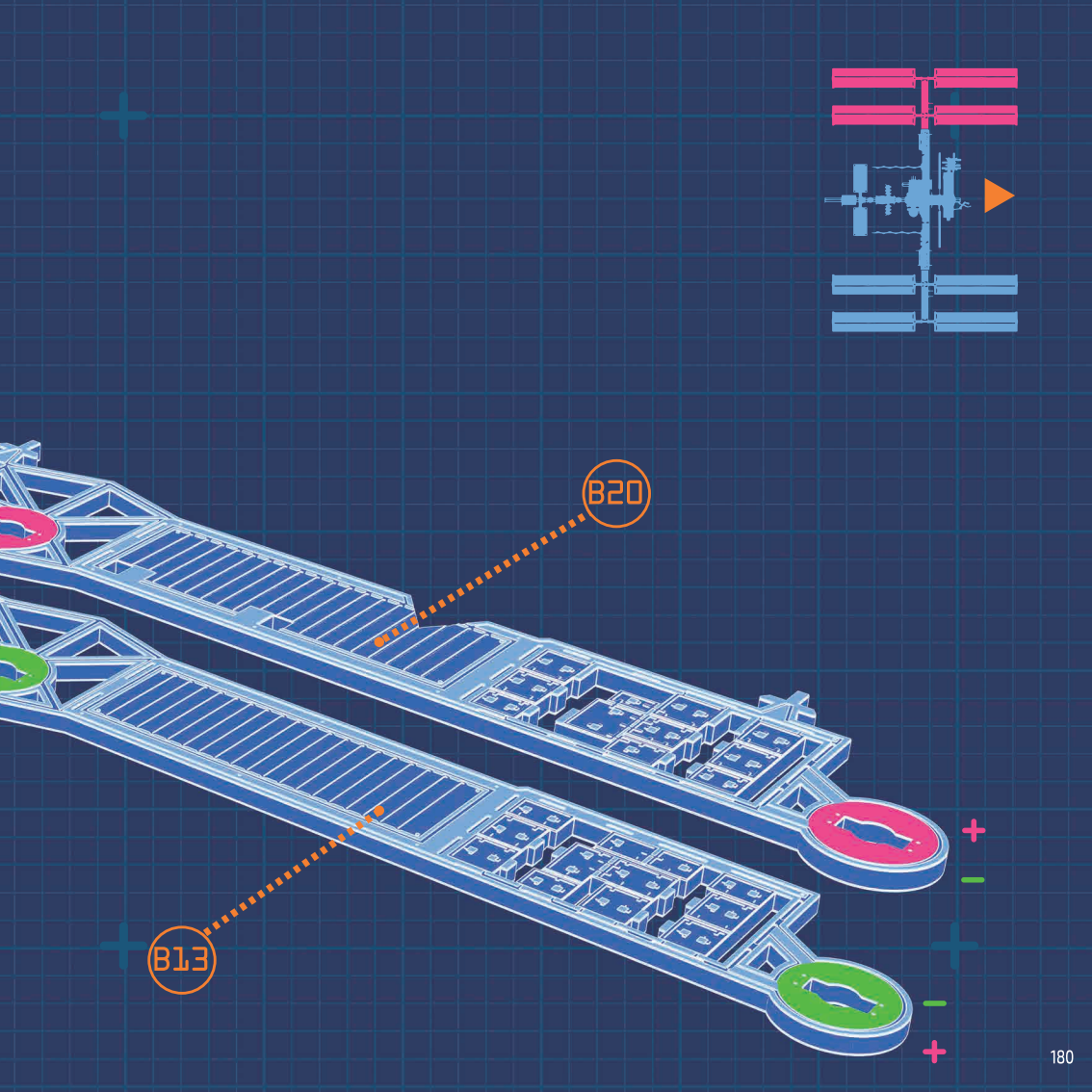

B20

B13

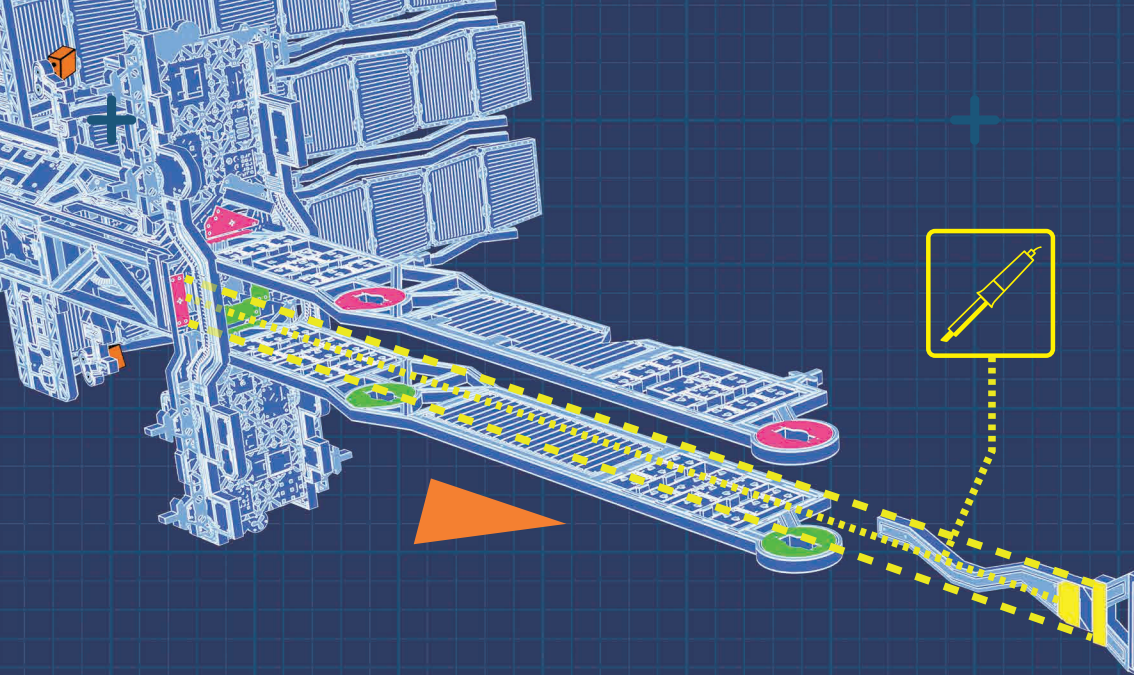

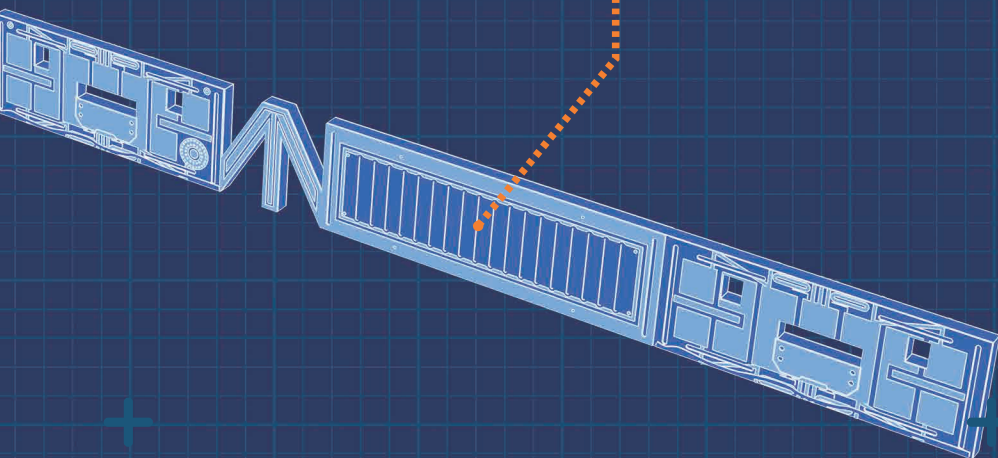

B16

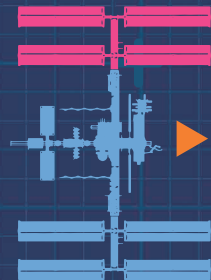

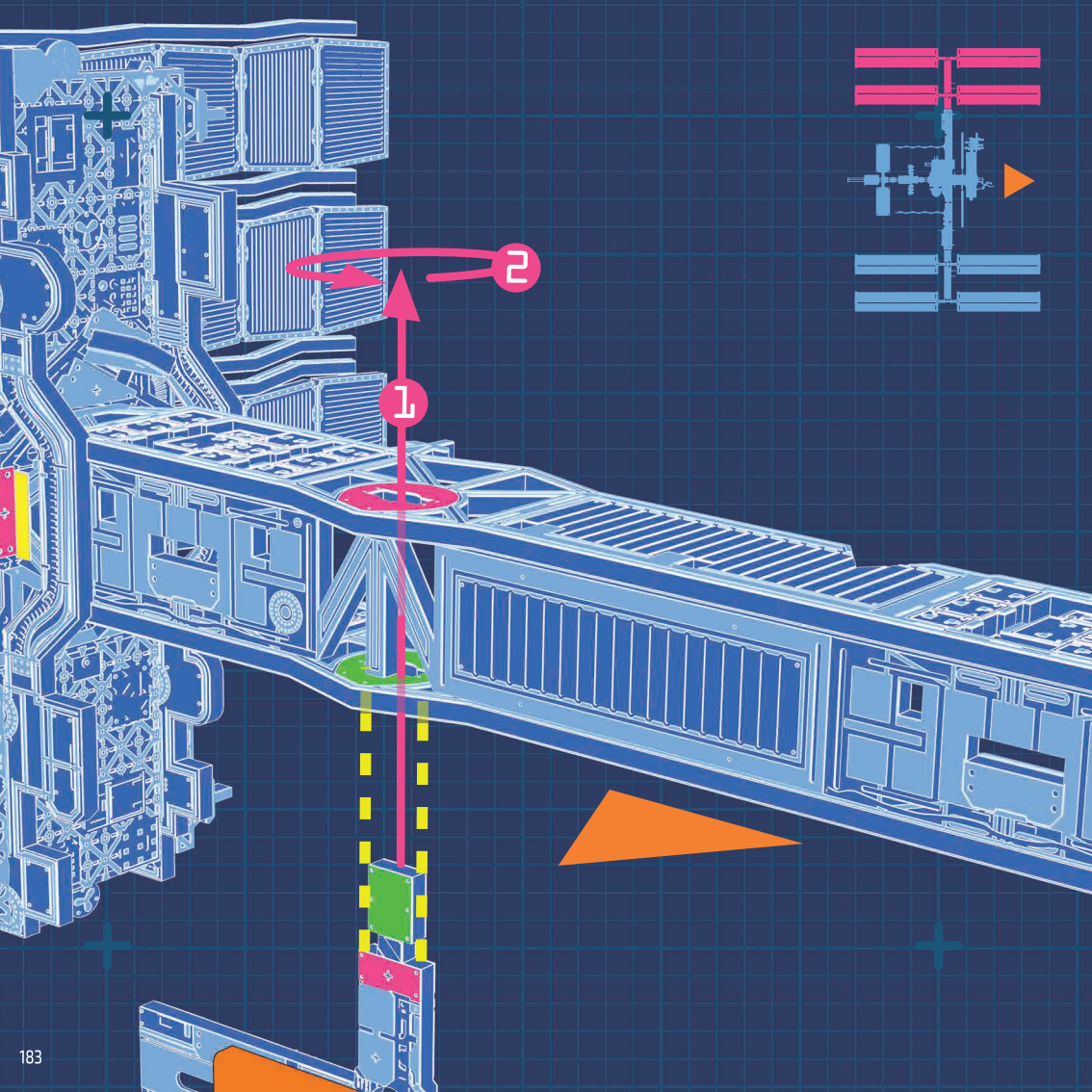

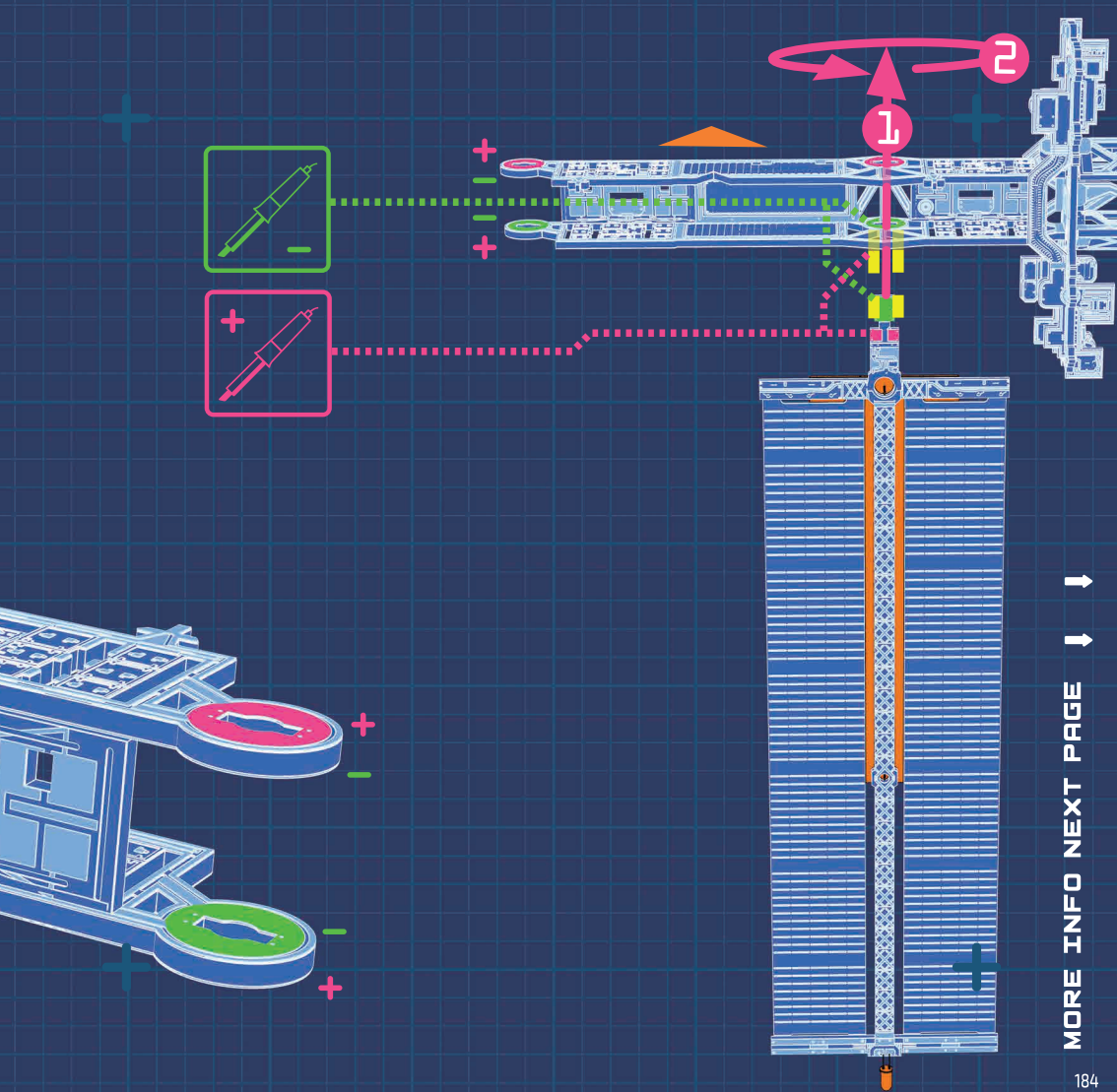

↑
↓
MORE INFO NEXT PAGE

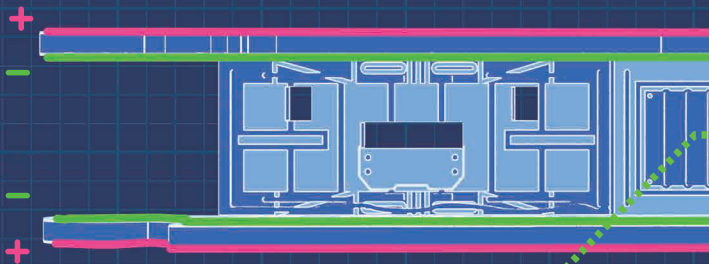
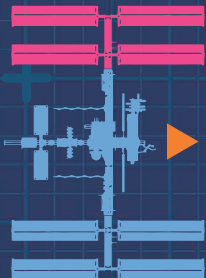

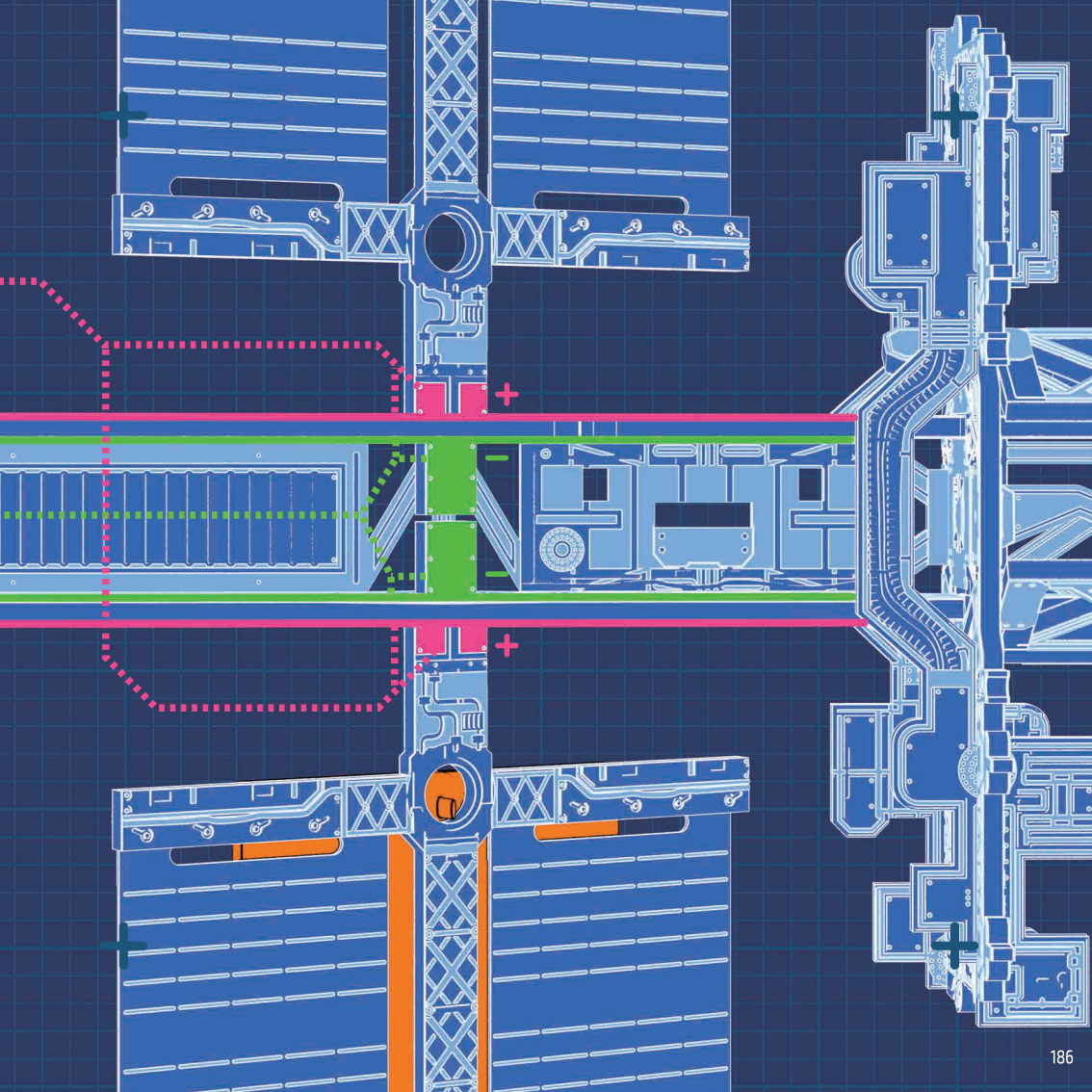

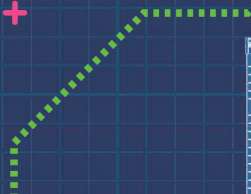

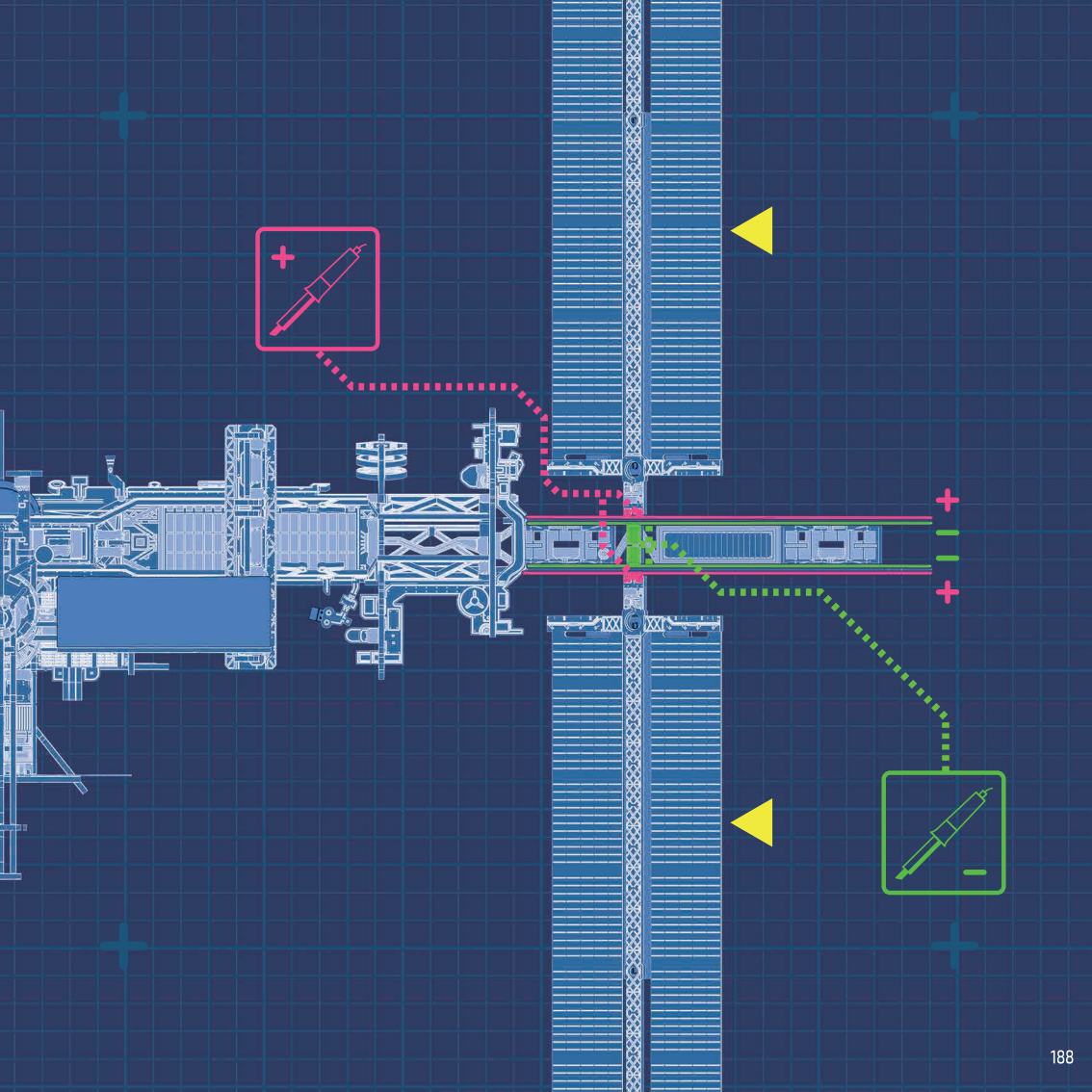

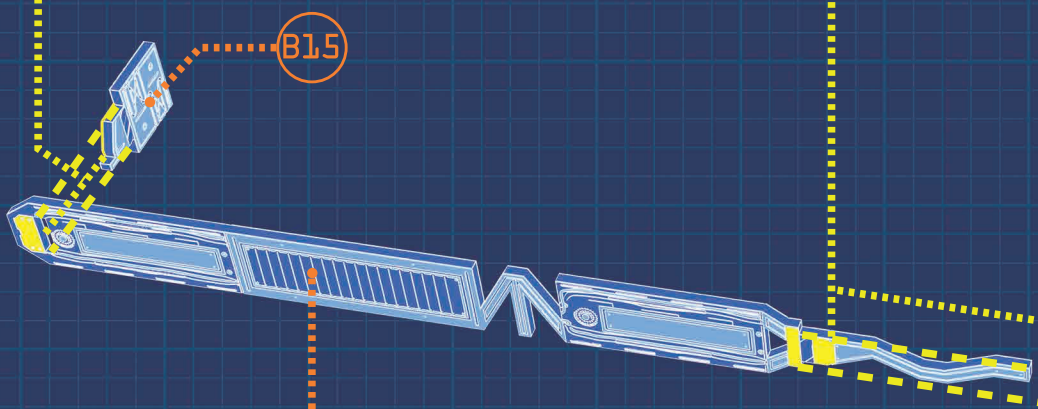

B1.5

B1.7

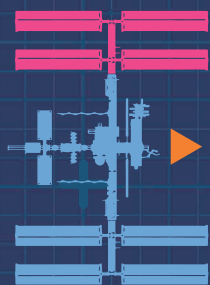

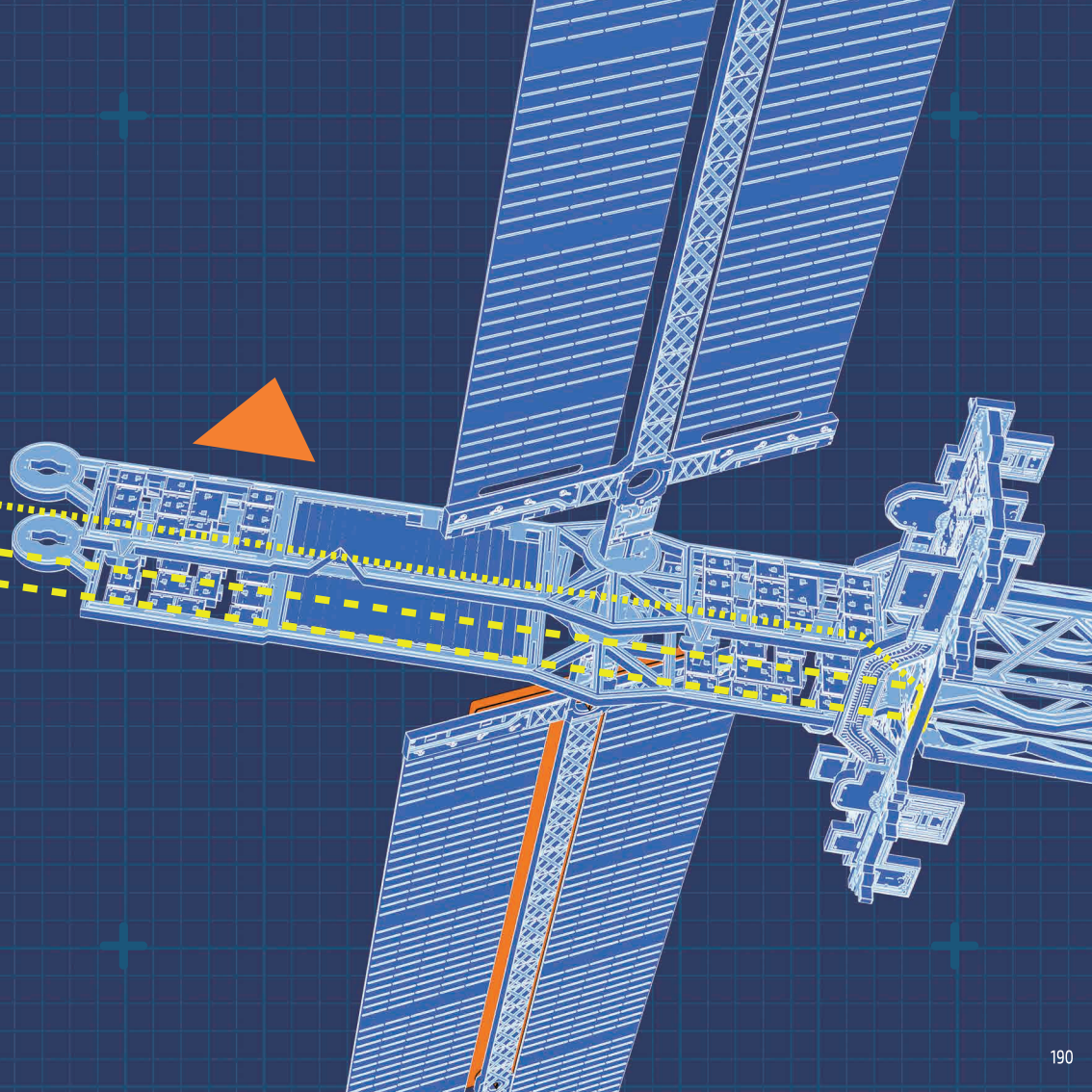

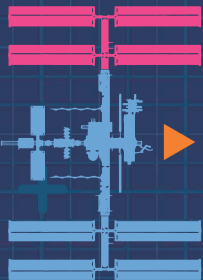
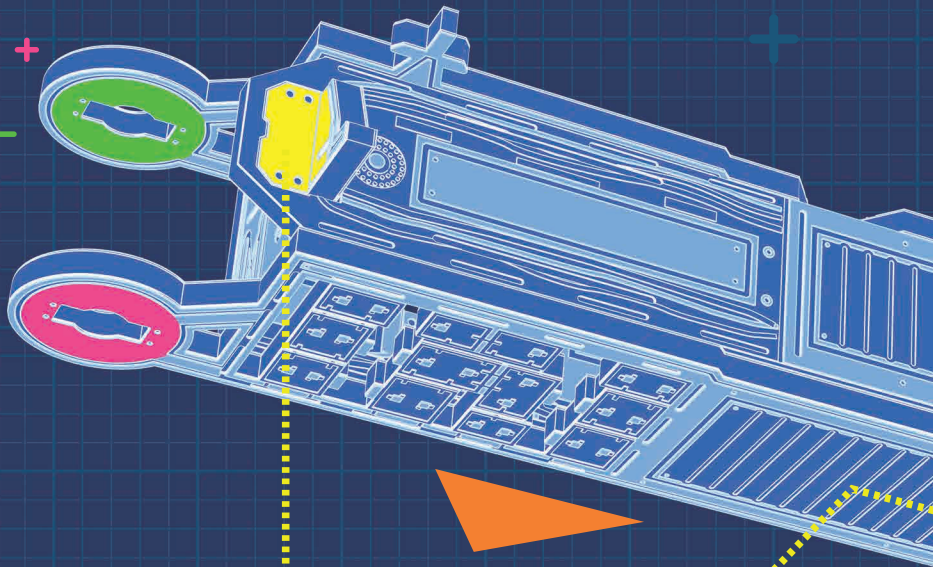

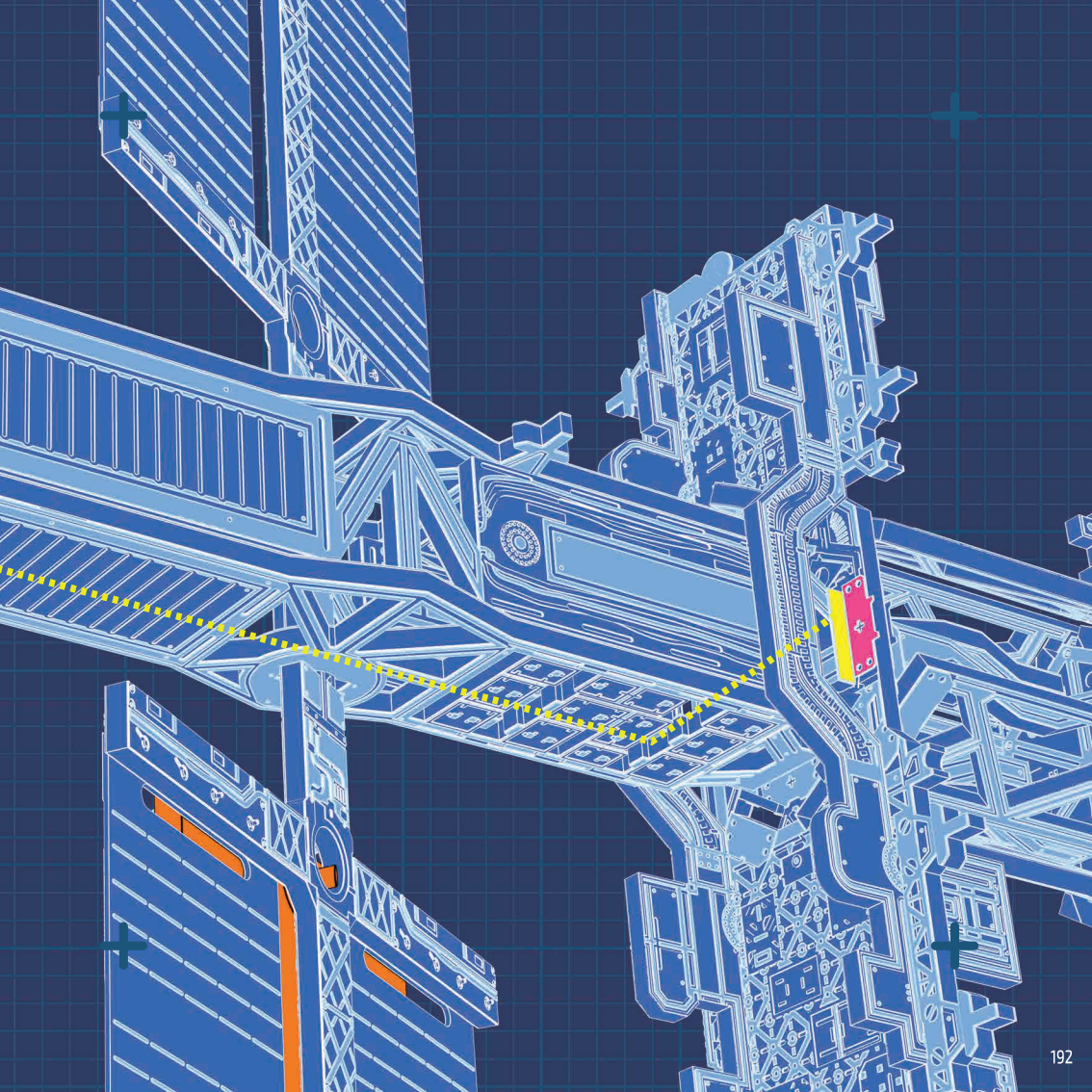

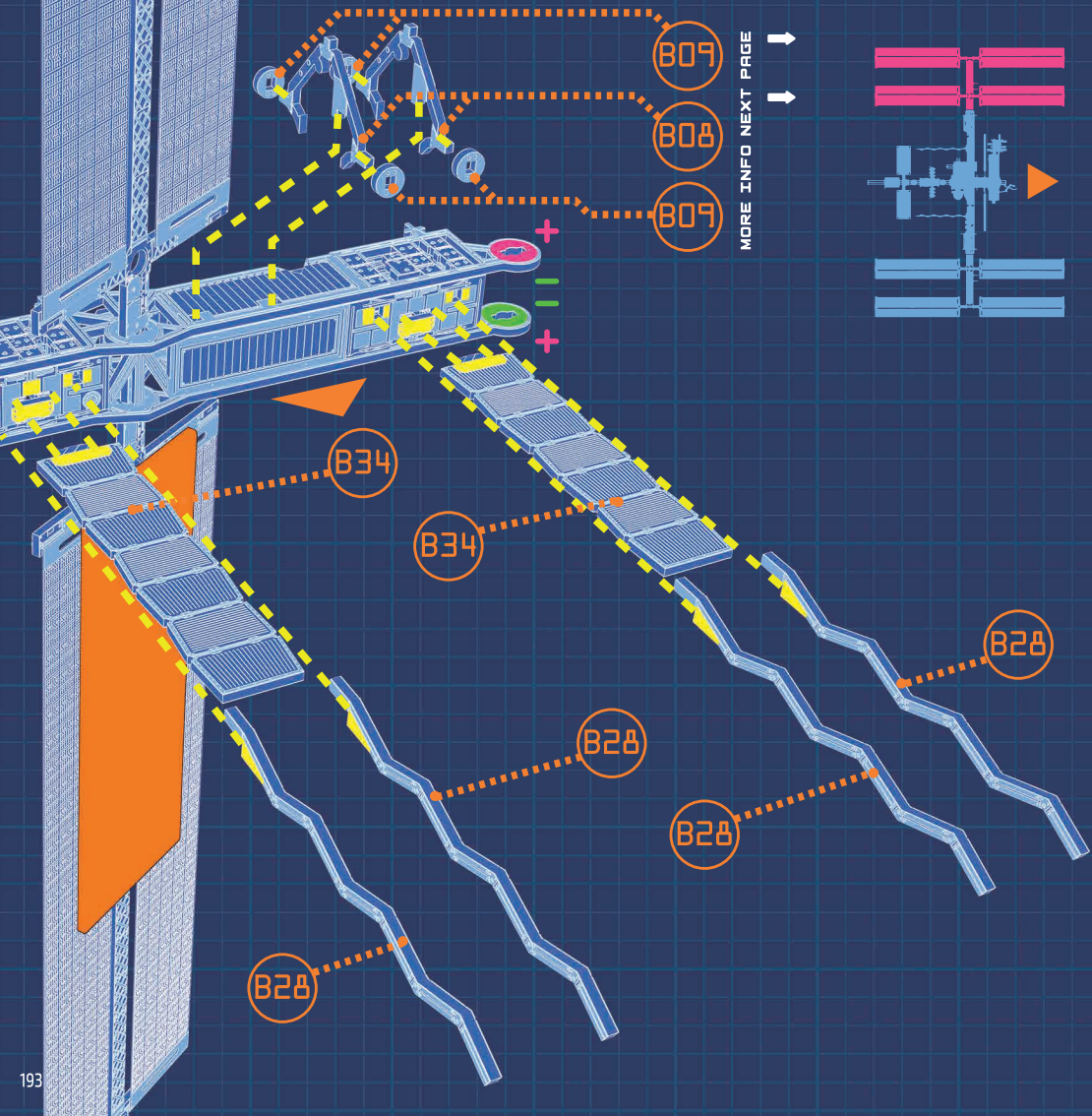

MORE INFO NEXT PAGE

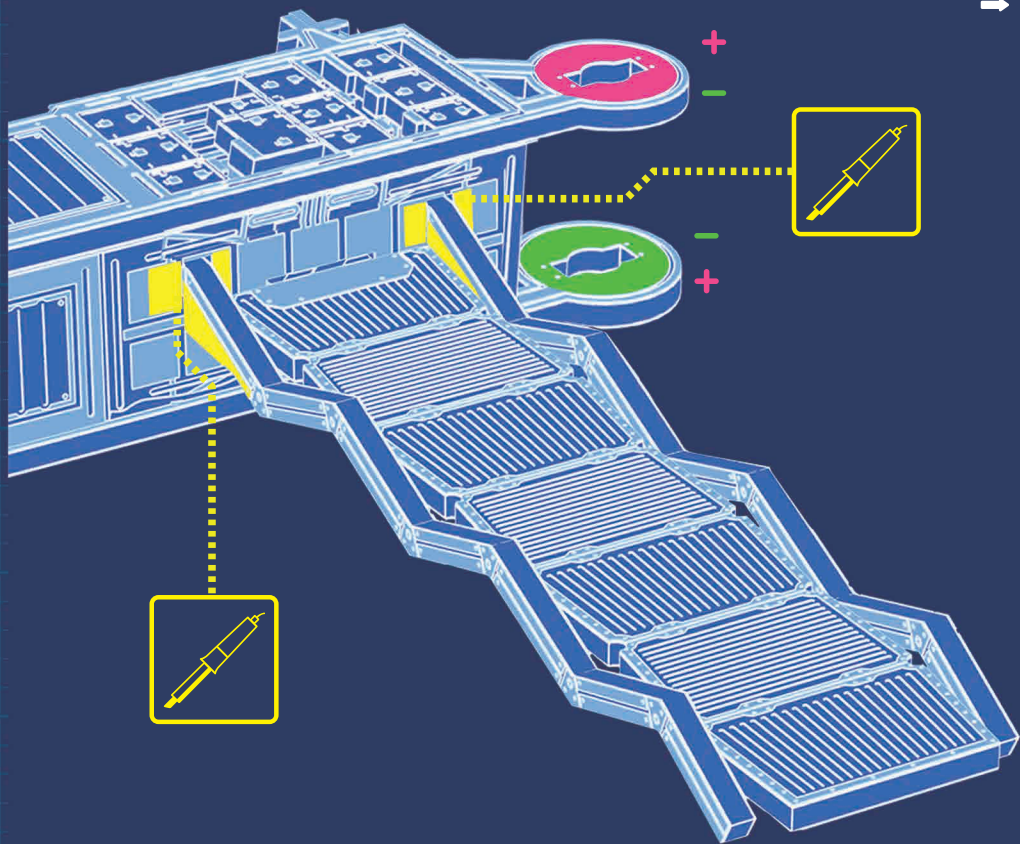

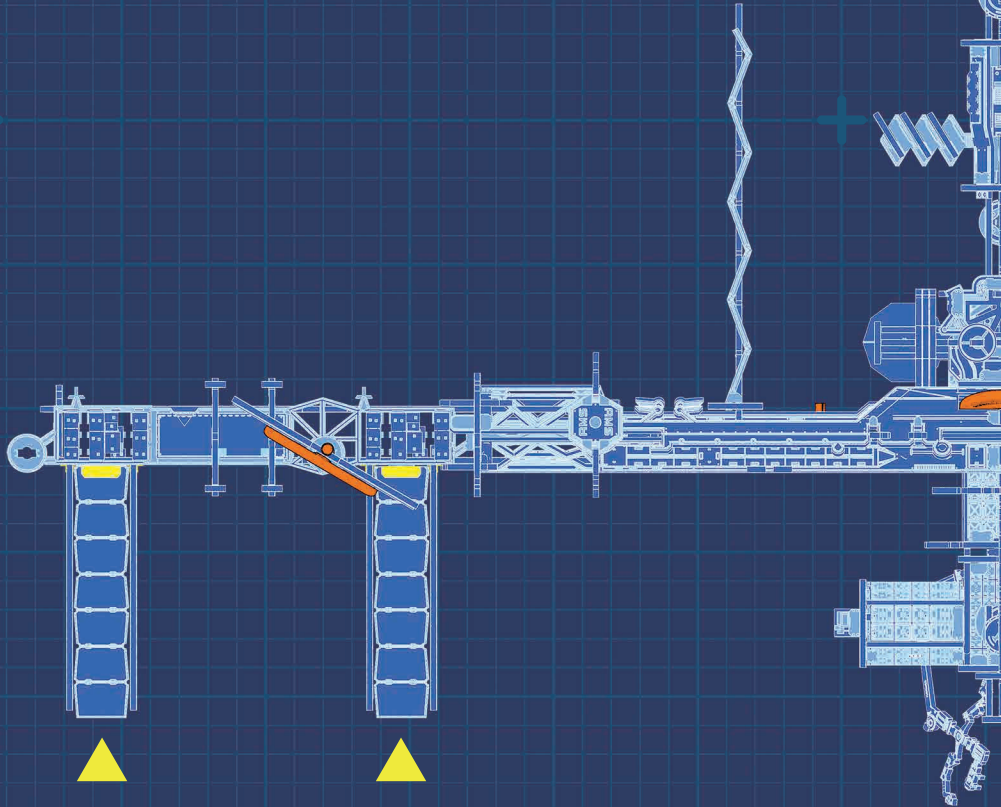

MORE INFO NEXT PAGE

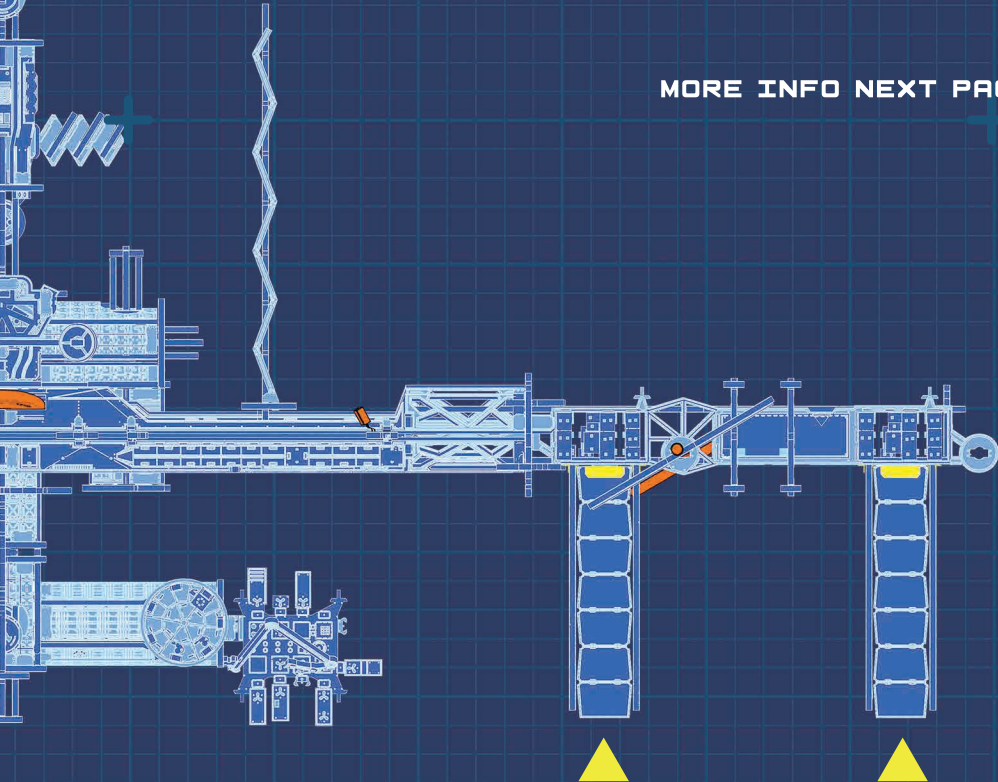

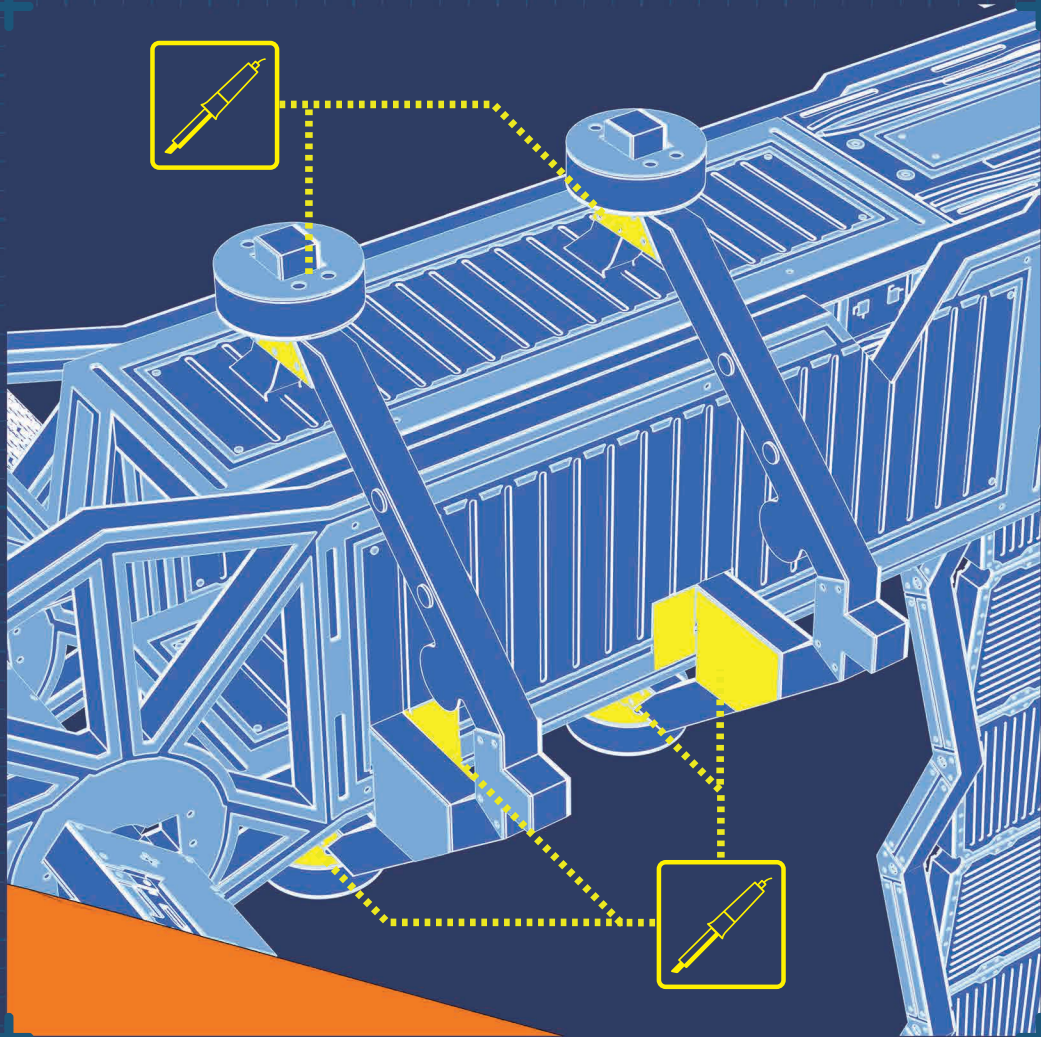

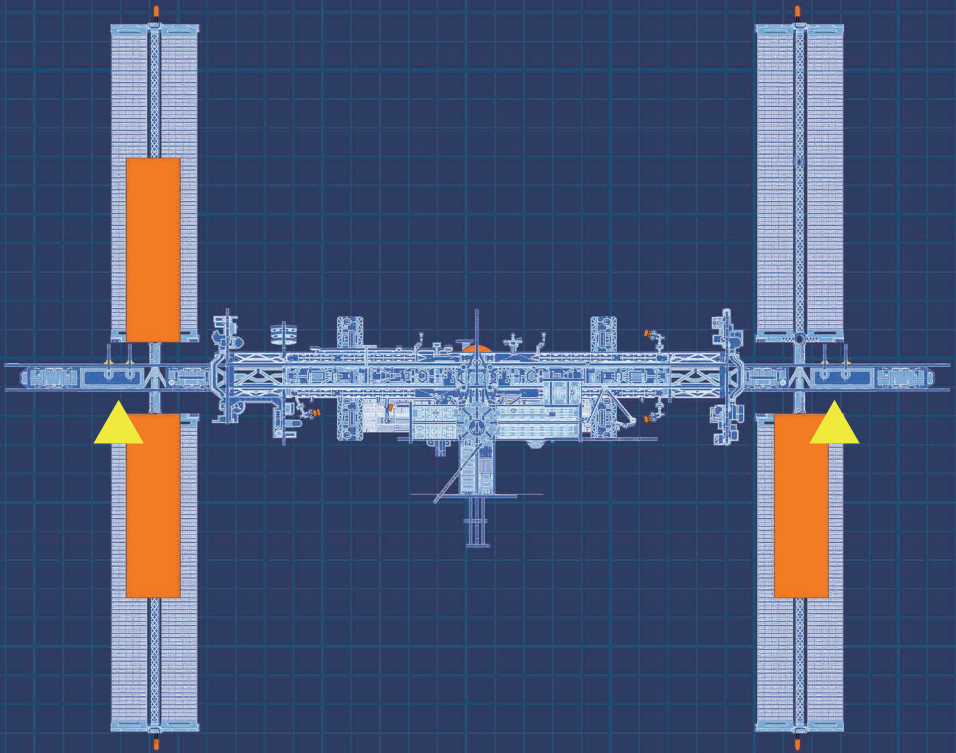

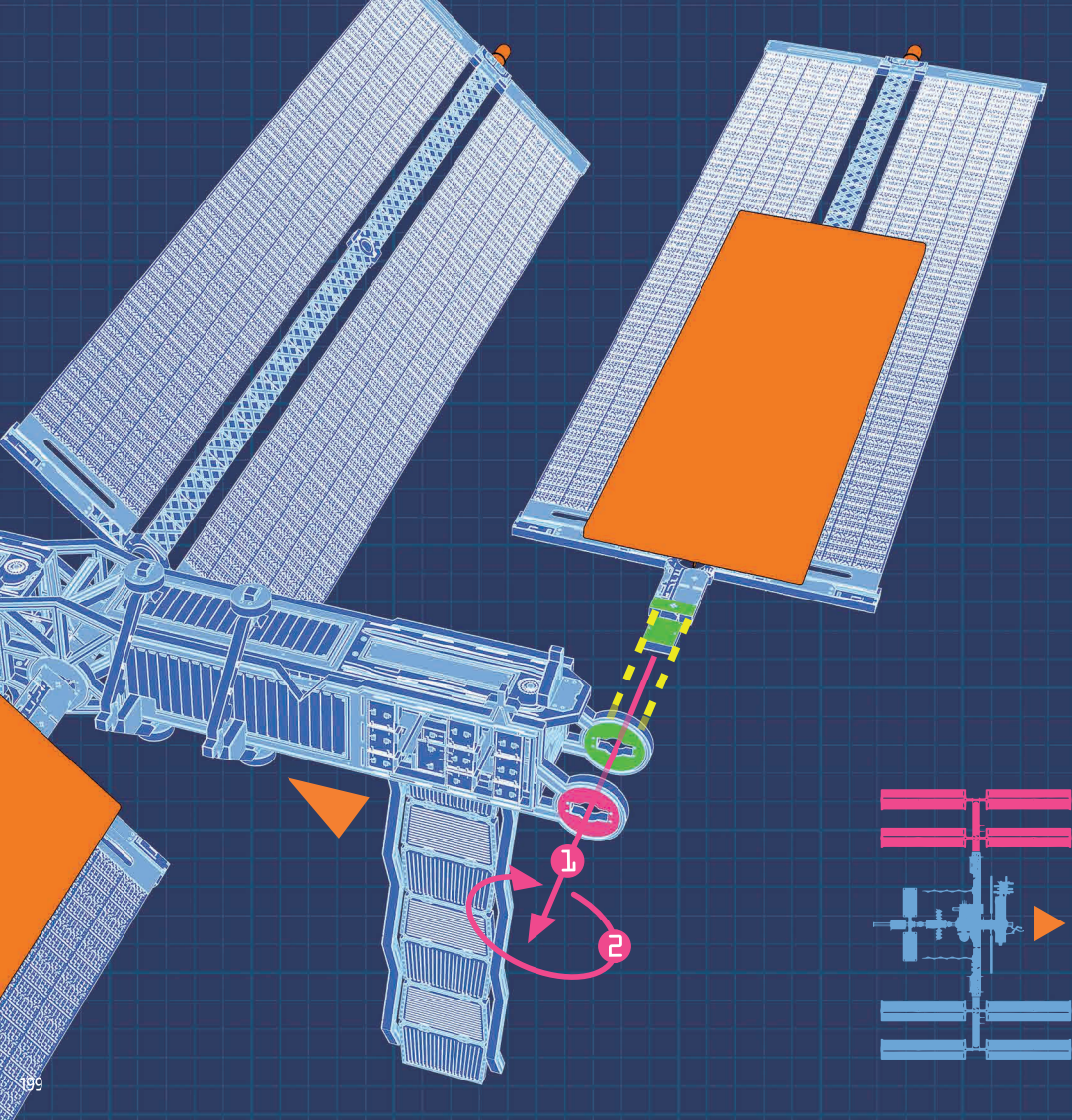

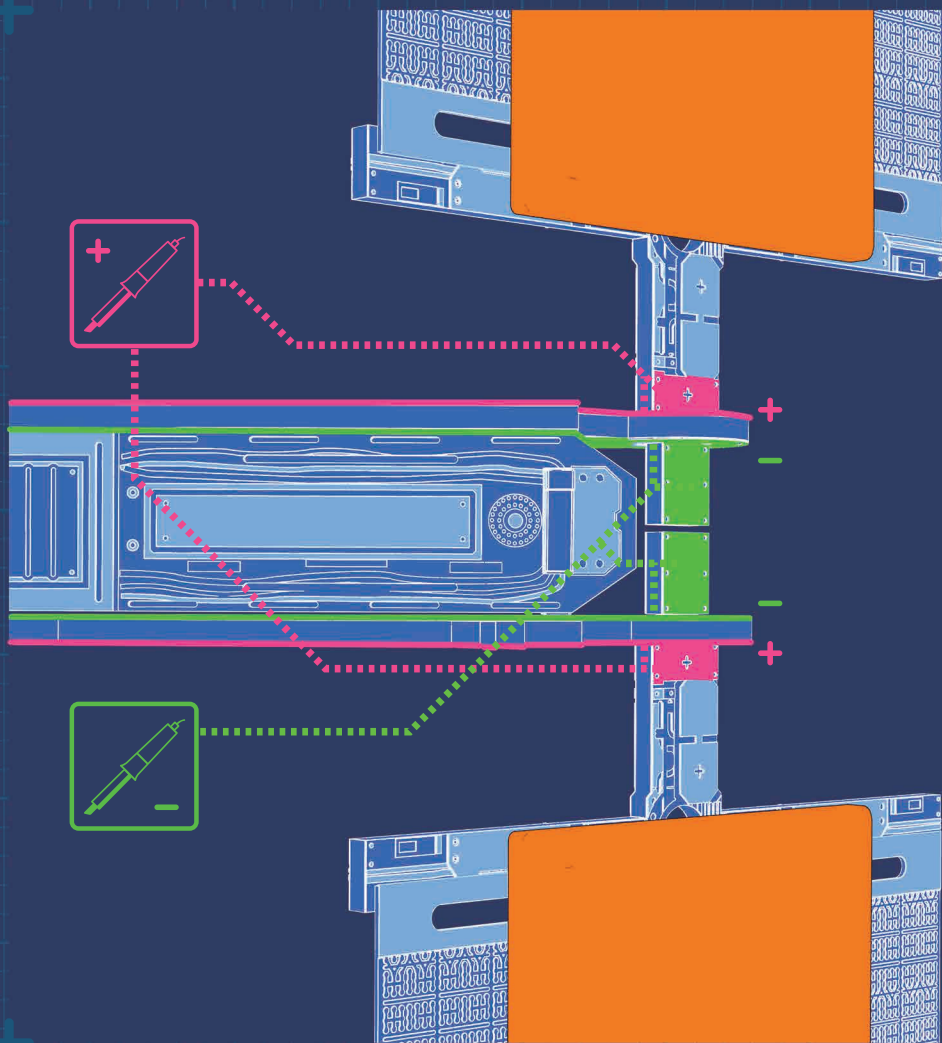

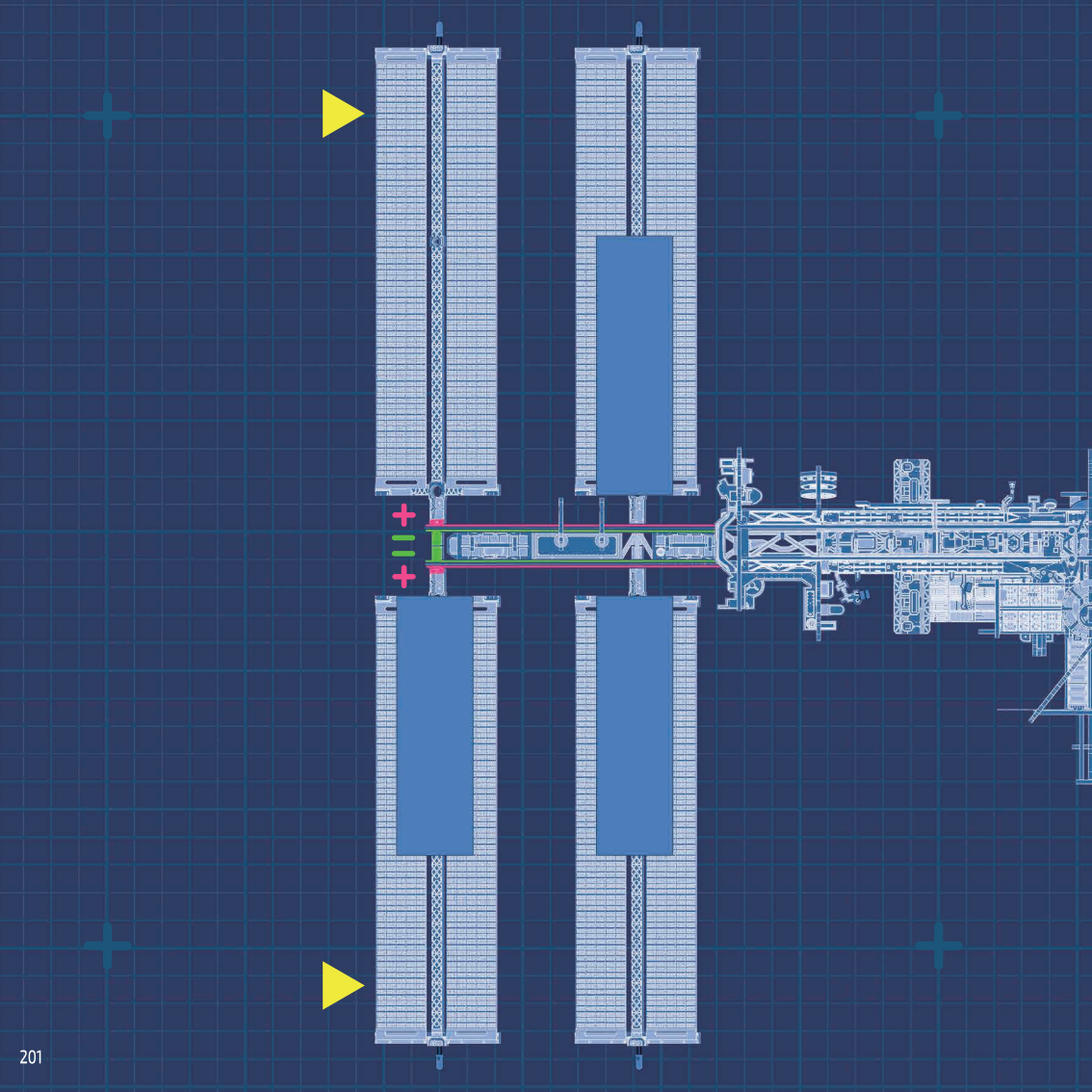

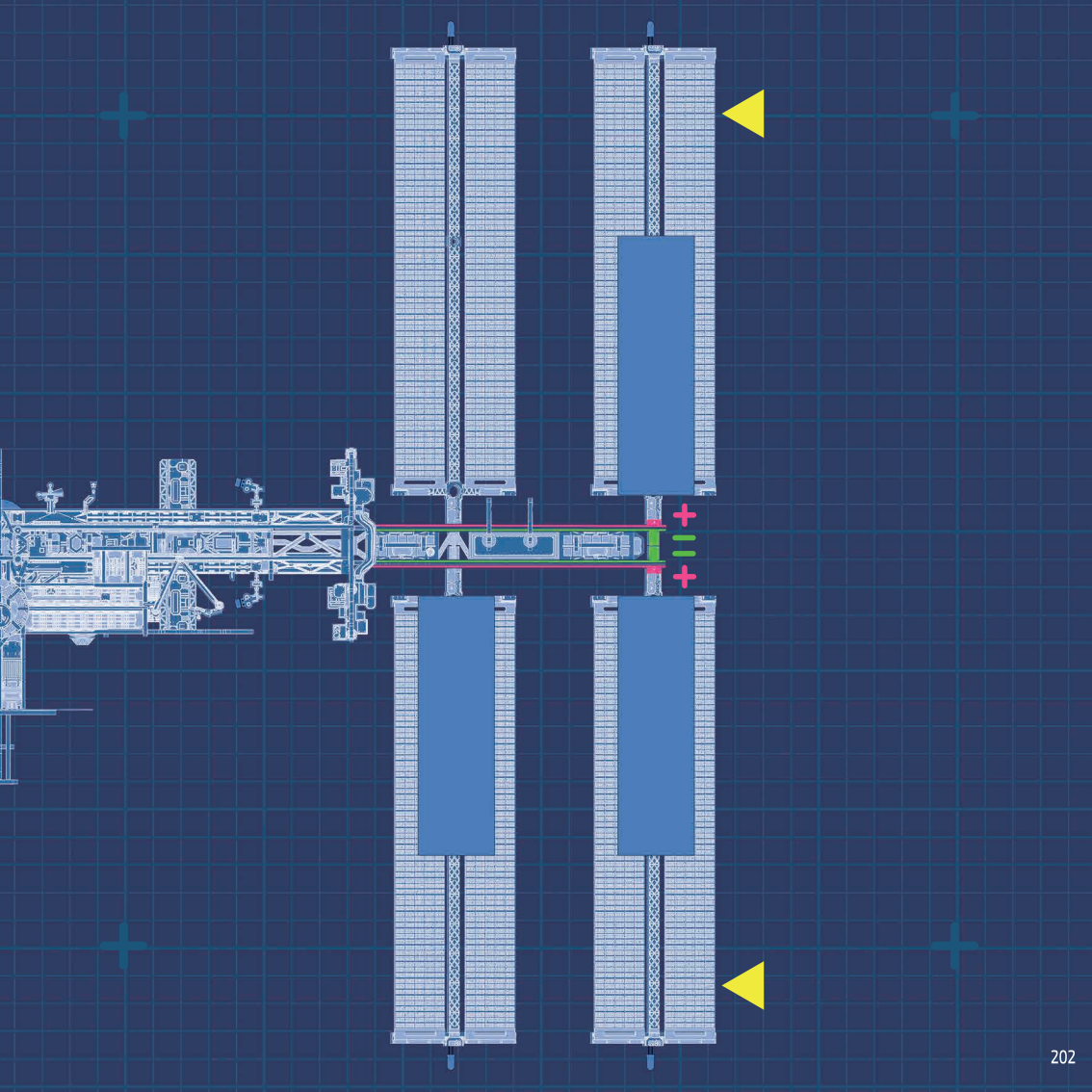

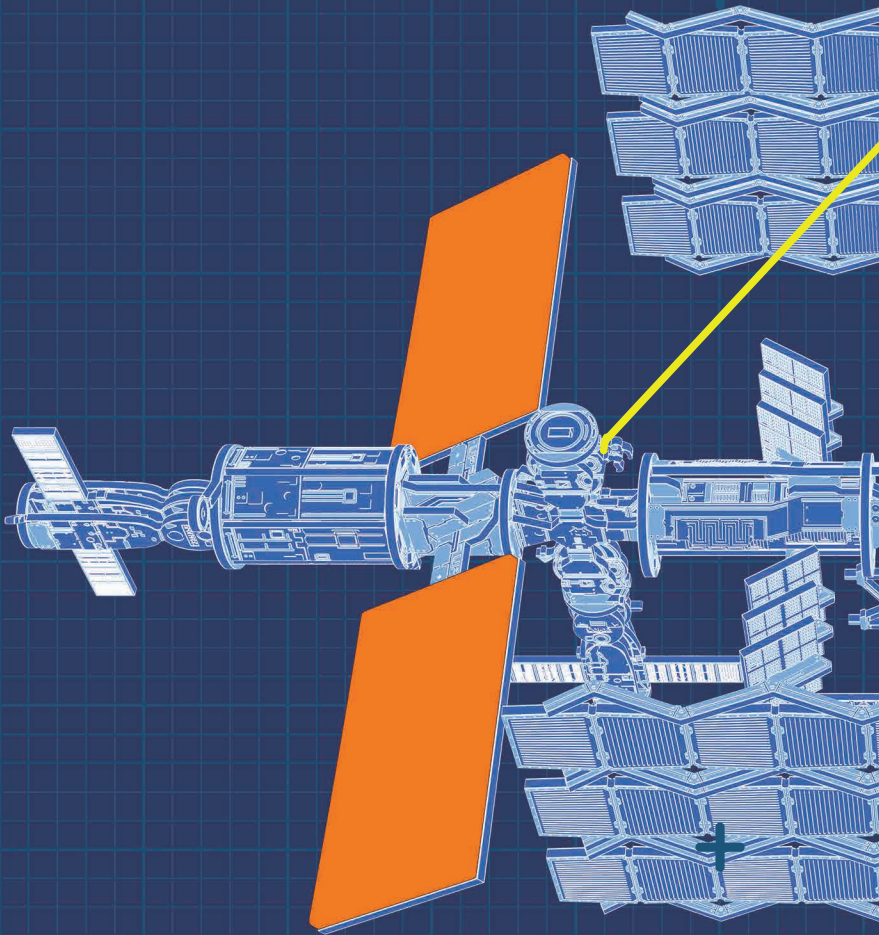

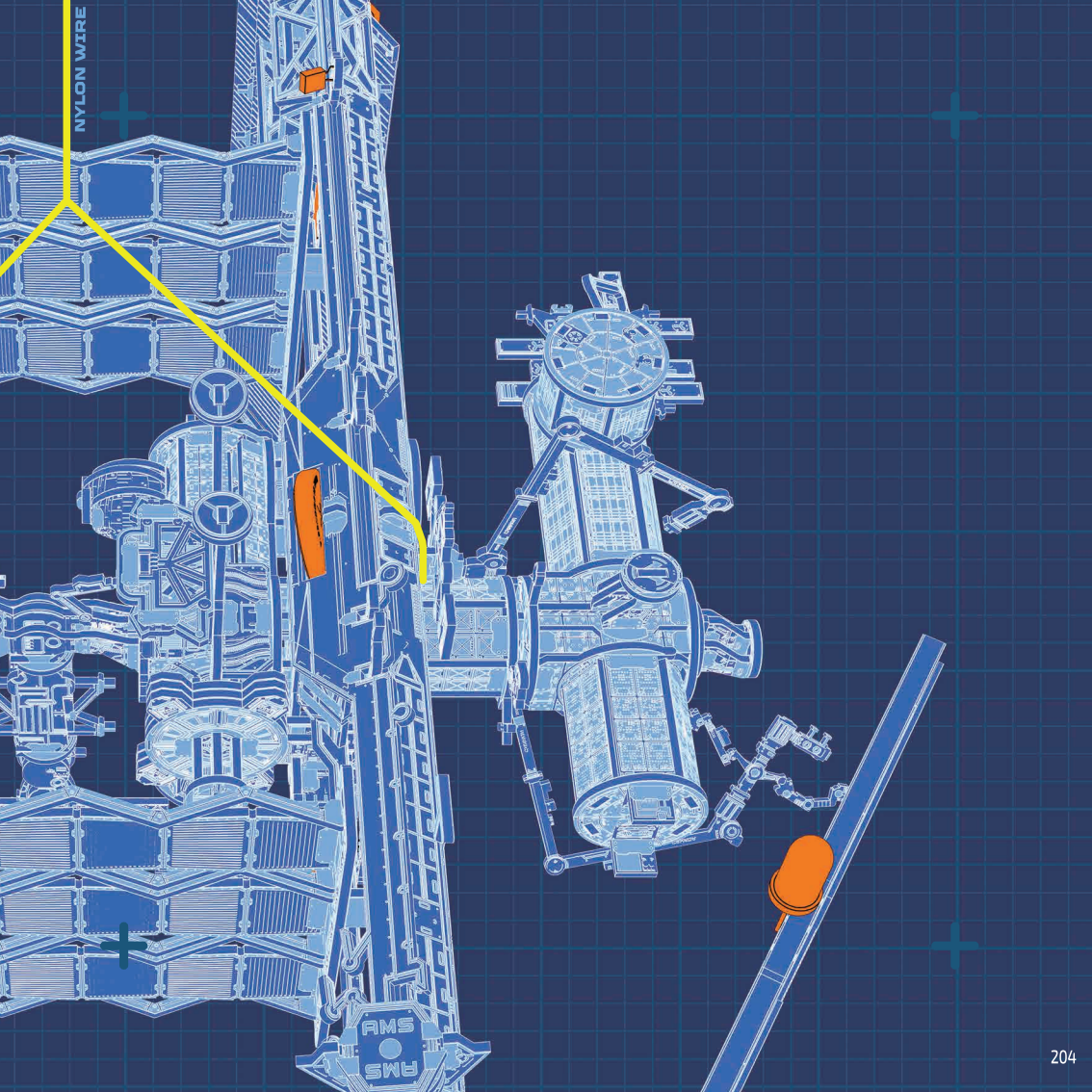

NYLON WIRE

AMS
AMS

LIFT OFF

KEEP SAFE

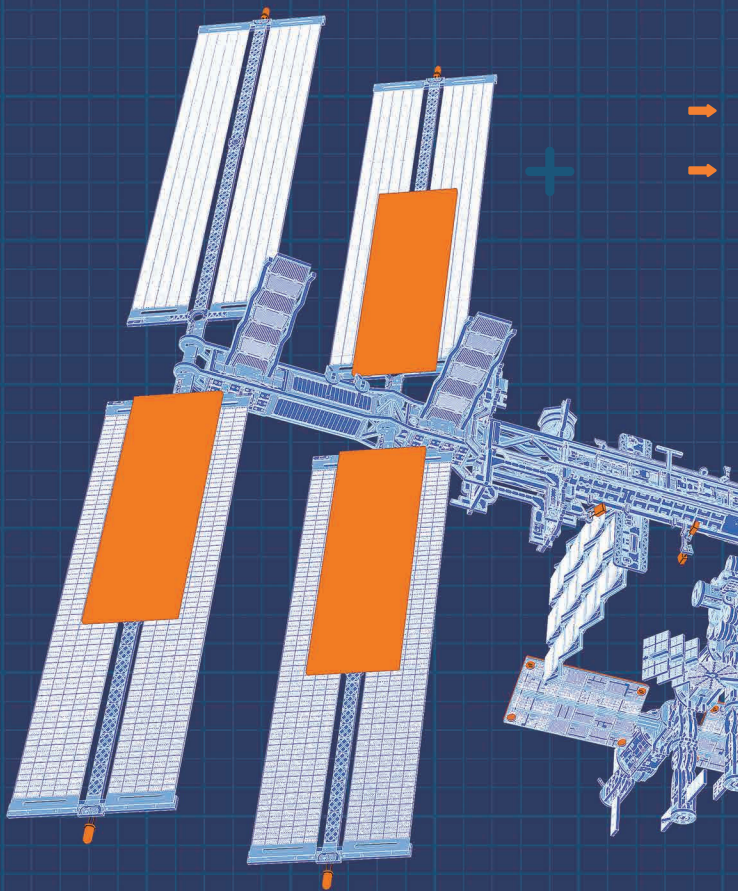

▶ KEEP SAFE

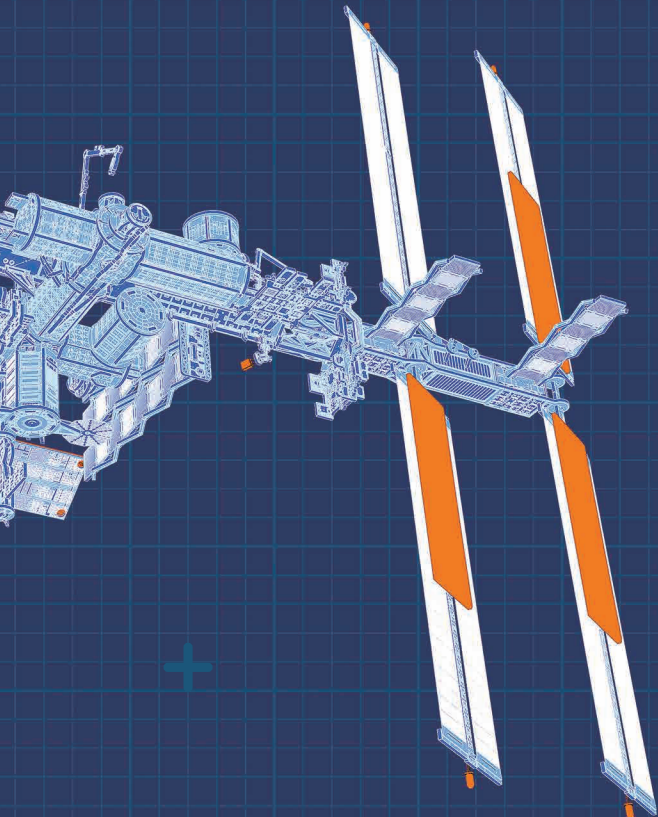

▶ KEEP SAFE



LIFT OFF

KEEP SAFE



READ BEFORE FLIGHT



f/@ WE.ARE.GEEKCLUB

MORE FUN STUFF ON OUR WEBSITE !!!
A QUESTION ? SOME COMMENTS ?

WWW.GEEKCLUB.COM

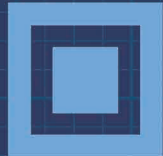

KEEP SAFE