

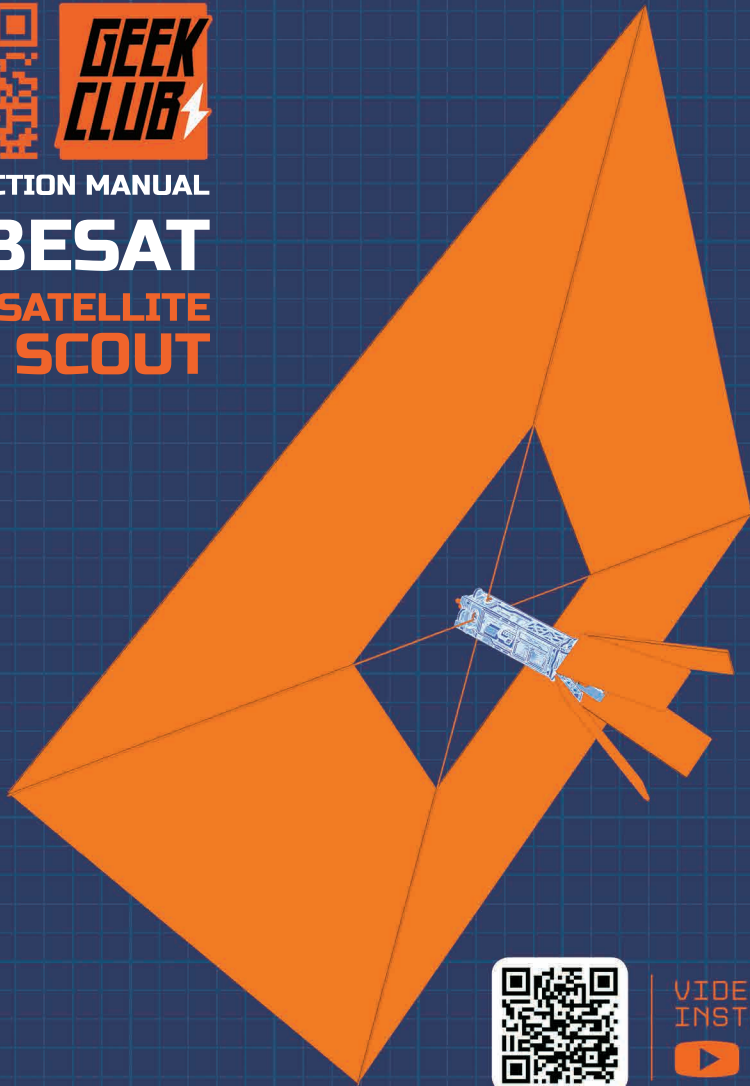

INSTRUCTION MANUAL

CUBESAT

CUBE SATELLITE
NEA SCOUT



KEEP SAFE ▶

READ BEFORE FLIGHT



VIDEO
INSTRUCTIONS



GEEKCLUB.COM



SMALL COMPONENTS



CLIPPING ELEMENTS

RoHS

CERTIFIED



ADULT SUPERVISION



CHOKING HAZARD



LEAD FREE



THIS MIGHT HELP



FUN PCB



USING GLASSES WHEN SOLDERING

**ASSEMBLE AND SOLDER THIS KIT
IN A WELL-VENTILATED AREA**

READ BEFORE FLIGHT



TOOLS YOU NEED

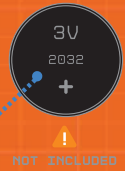

SOLDERING IRON

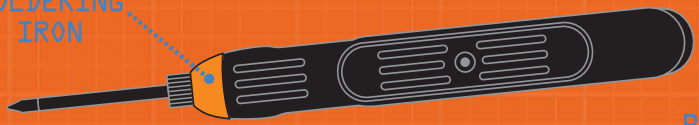

BATTERY

TWEEZERS

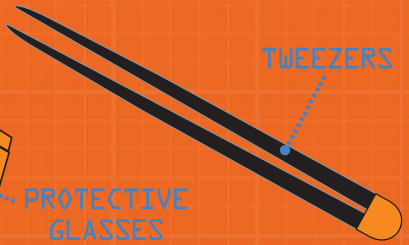

PROTECTIVE GLASSES

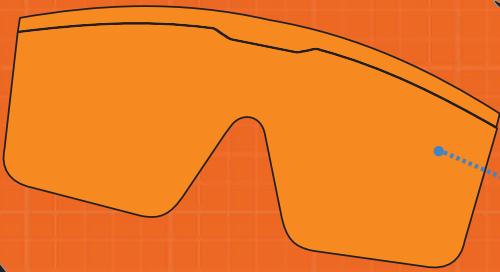

PLIERS

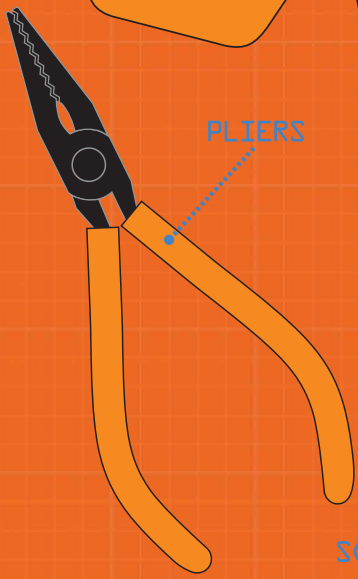

CUTTER

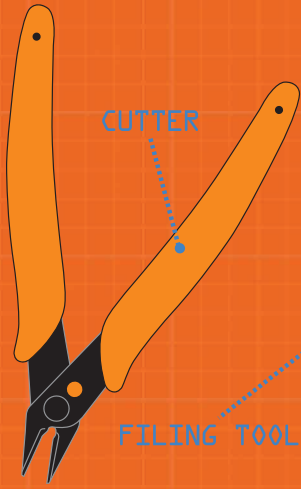

SOLDER WIRE

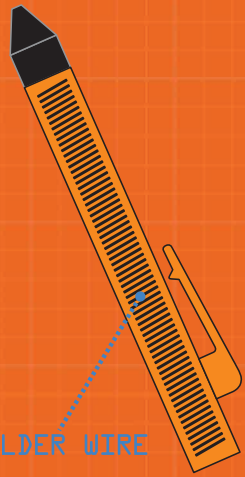

FILING TOOL



READ BEFORE FLIGHT

KEEP SAFE

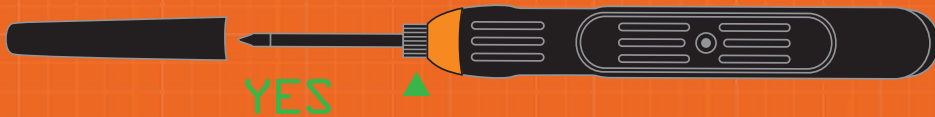
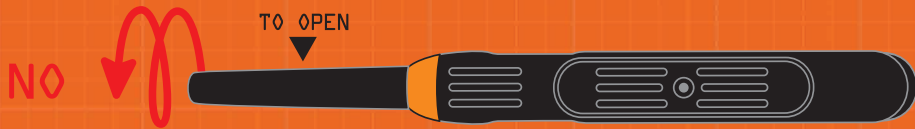

KEEP SAFE

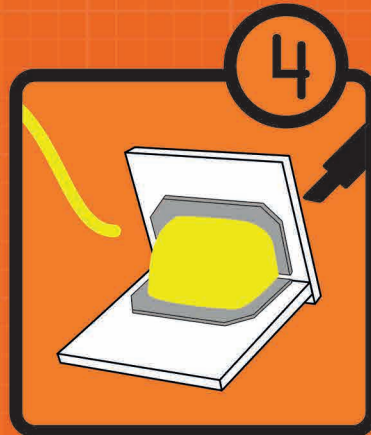
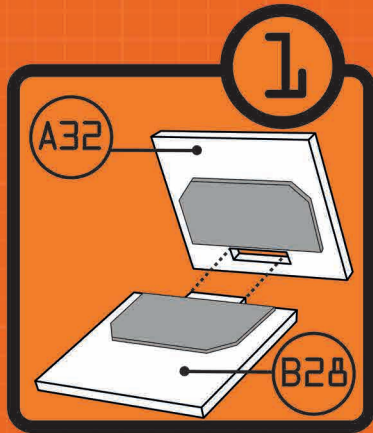

NOTE:

FOR BEST QUALITY JOINTS, HEAT BOTH METAL PARTS WITH THE SOLDERING IRON IN QUICK SUCCESSION. ADD SOLDER BETWEEN THE METAL PARTS, DO NOT USE SOLDER ON THE ENTIRE PAD.

HOW TO READ THE INSTRUCTIONS_

READ BEFORE FLIGHT

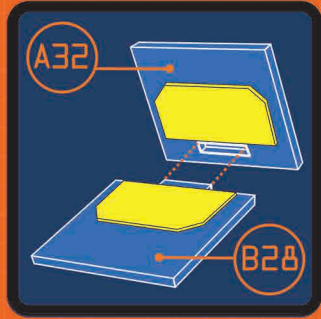

YELLOW PADS



SOLDER YELLOW ELEMENTS TOGETHER

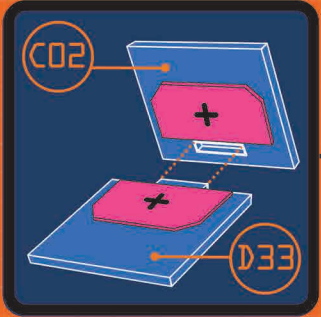

PINK PADS



SOLDER PINK ELEMENTS MARKED WITH + TOGETHER



OPTIONAL SOLDERING YOU CAN SOLDER THE LED PINS FOR EXTRA GRIP



SOLDER + WITH + AND - WITH -

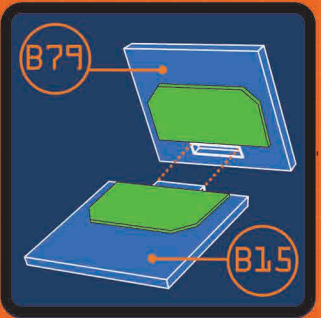

GREEN PADS



SOLDER PINK ELEMENTS MARKED WITH - TOGETHER



OPTIONAL SOLDERING YOU CAN SOLDER THE LED PINS FOR EXTRA GRIP

KEEP SAFE ▶

EACH PART IS MARKED WITH A LETTER AND NUMBER

THIS CODE INDICATES THE PART'S LOCATION

THE LETTER CORRESPONDS TO THE BOARD. THE NUMBER SHOWS ITS LOCATION ON SAID BOARD

A32

B28

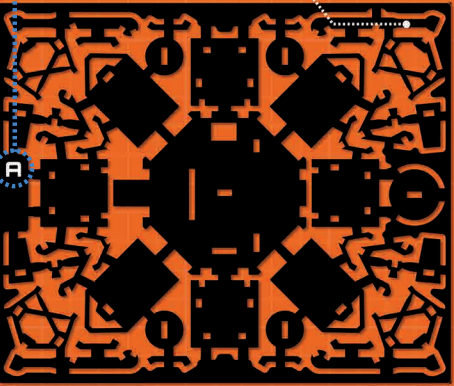

BOARD A



BOARD B

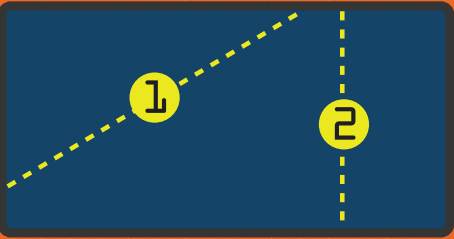

PROCEED STEP BY STEP FOLLOWING AN ASCENDING ORDER

1 ▶ 2 ▶ 3 ▶ ...

READ BEFORE FLIGHT

KEEP SAFE ▶

KEEP SAFE



CUBESAT CUBE SATELLITE NEA SCOUT



KEEP SAFE

READ BEFORE FLIGHT

▶ KEEP SAFE

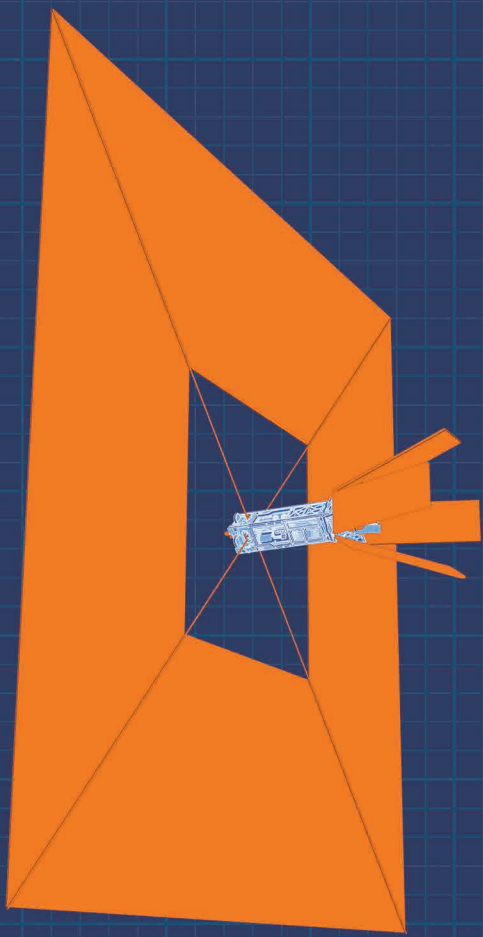

▶ KEEP SAFE



**MORE TIPS AND DETAILS
IN OUR ONLINE
INSTRUCTION VIDEO**



WWW.GEEKCLUB.COM



COMPONENTS AND OTHER ELEMENTS_

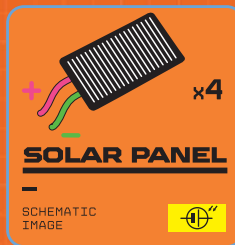
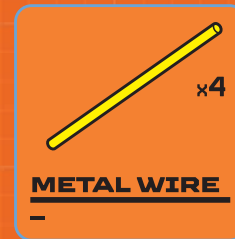
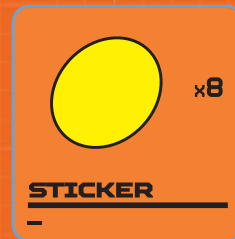
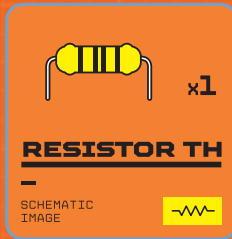

NOTE:

1. DON'T WORRY IF YOU LOSE A FEW LEDS, WE'VE GOT YOU COVERED - THERE ARE EXTRA DIODES IN THE KIT
2. MAKE SURE TO FOLLOW THE POLARITY + (PINK) AND - (GREEN) WHEN INSTALLING COMPONENTS. OTHERWISE, YOUR MODEL WILL NOT WORK.

FRONT

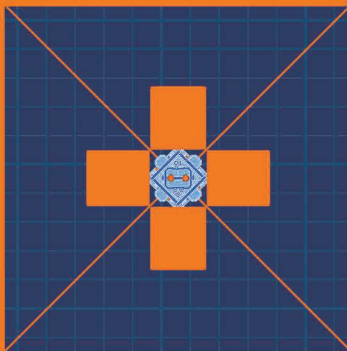

READ BEFORE FLIGHT

KEEP SAFE ▶

RIGHT

17.7"
450 MM

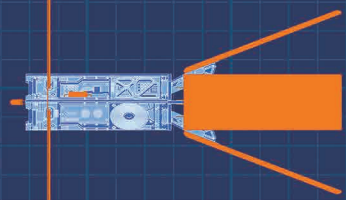

6.1"
155 MM

KEEP SAFE ▶

READ BEFORE FLIGHT

KEEP SAFE ◀

BACK

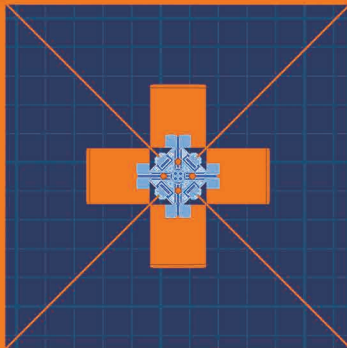

READ BEFORE FLIGHT

KEEP SAFE ◀

▶ KEEP SAFE

LEFT

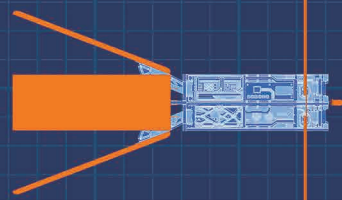

17.7"
450 MM

6.1"
155 MM

▶ KEEP SAFE

READ BEFORE FLIGHT

KEEP SAFE

TOP

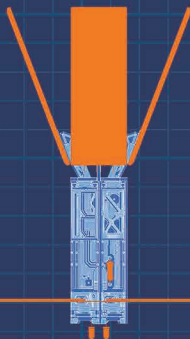

17.7"
450 MM



READ BEFORE FLIGHT

KEEP SAFE

BOTTOM

7.1"
180 MM

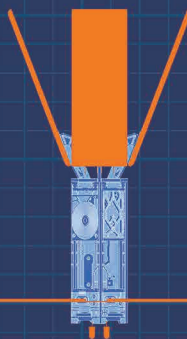

17.7"
450 MM

READ BEFORE FLIGHT

A07

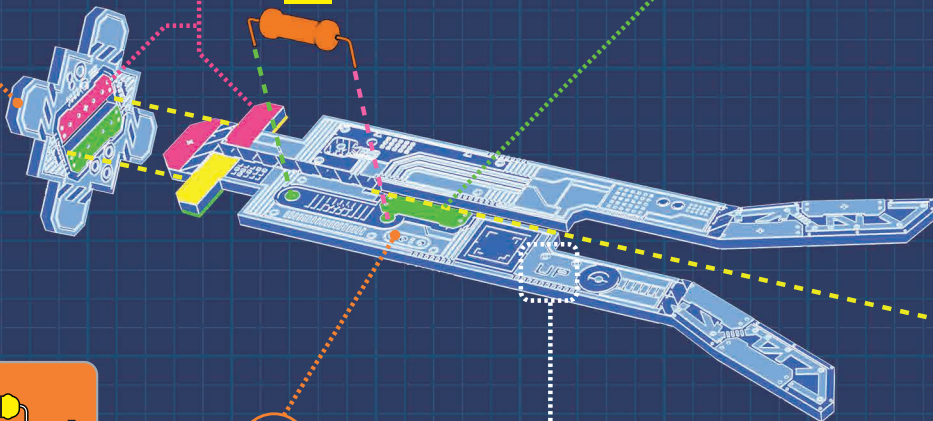

A02

UP

x1

RESISTOR TH

—

SCHEMATIC IMAGE

1

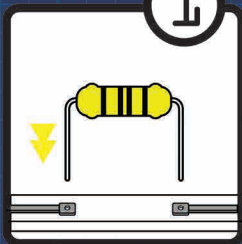

2

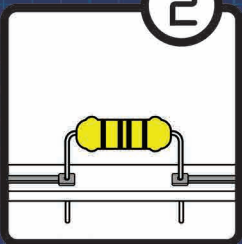

3

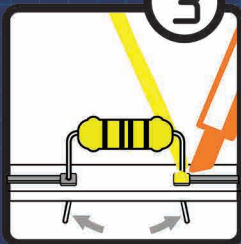

4

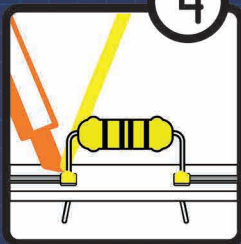



UP

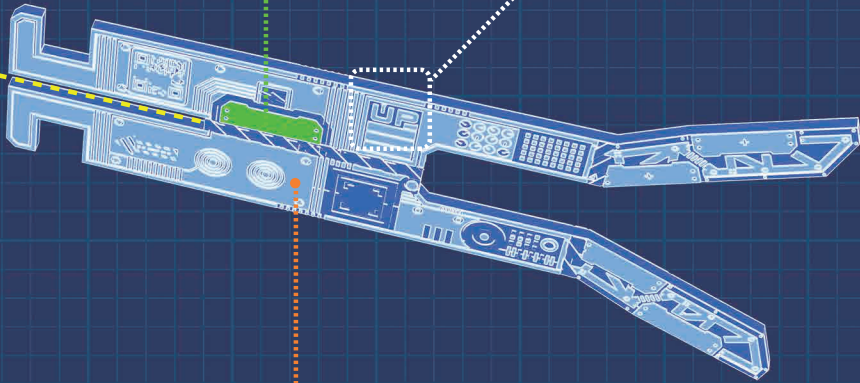

A03

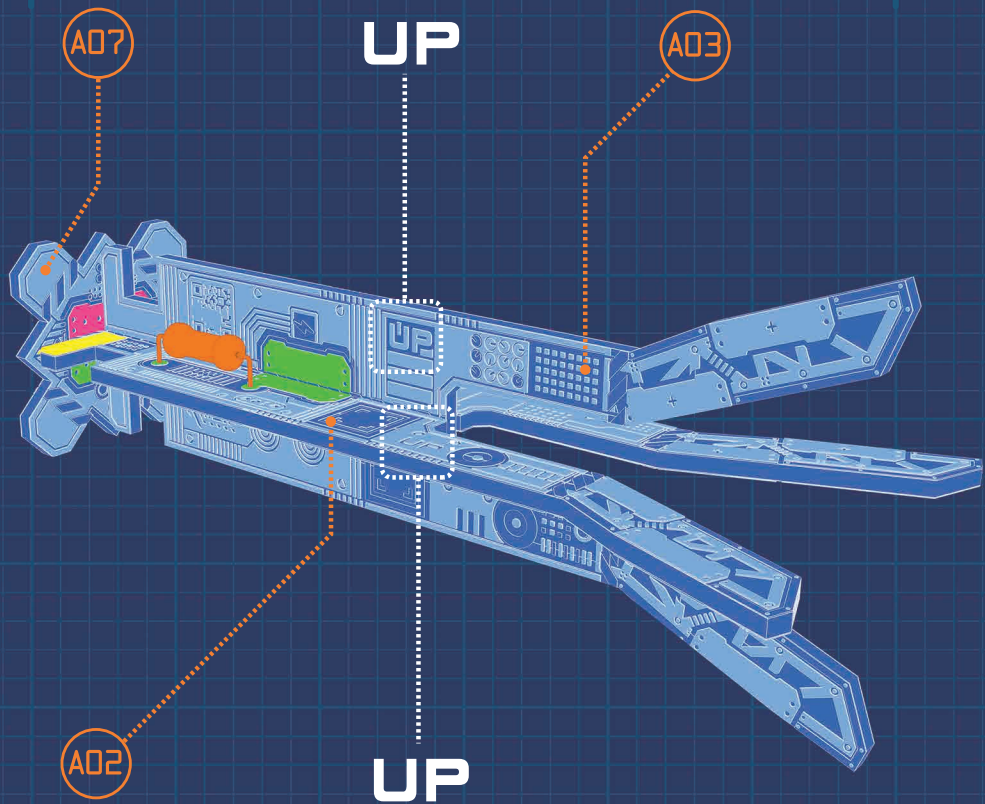

A07



A03

UP

A02



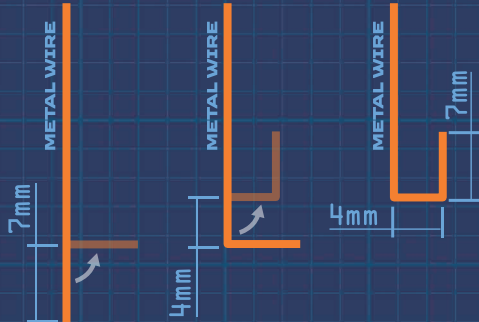
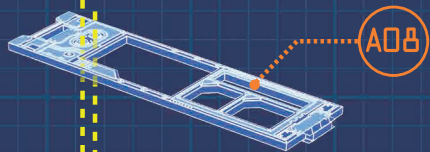

A08

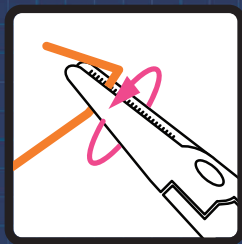
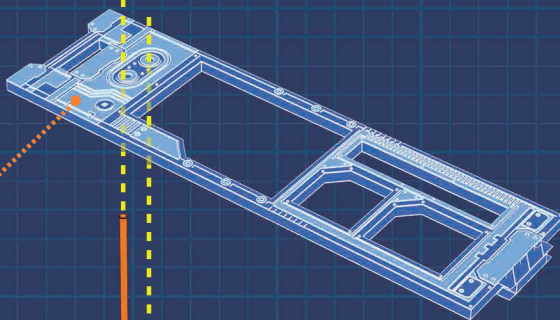

METAL WIRE

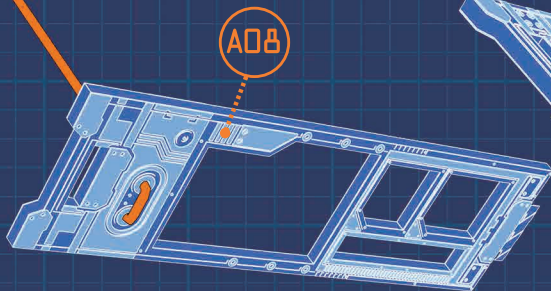

METAL WIRE

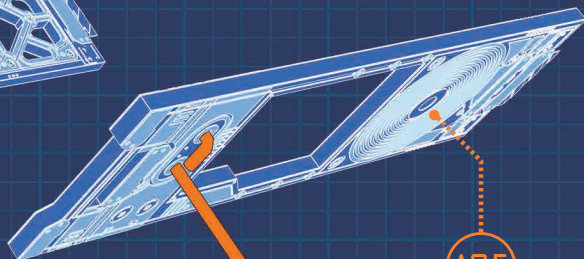
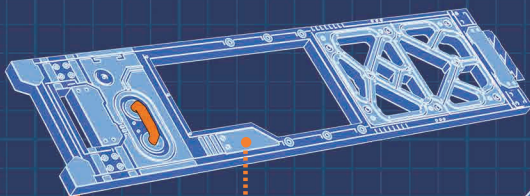
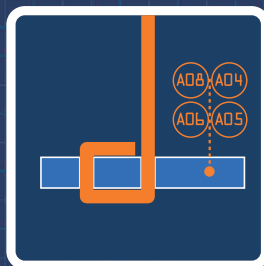
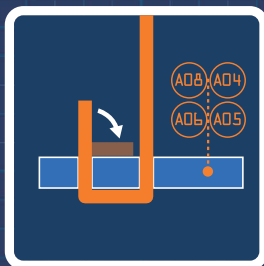
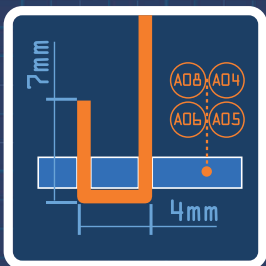
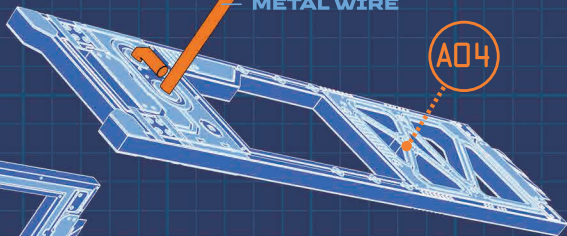

METAL WIRE

METAL WIRE

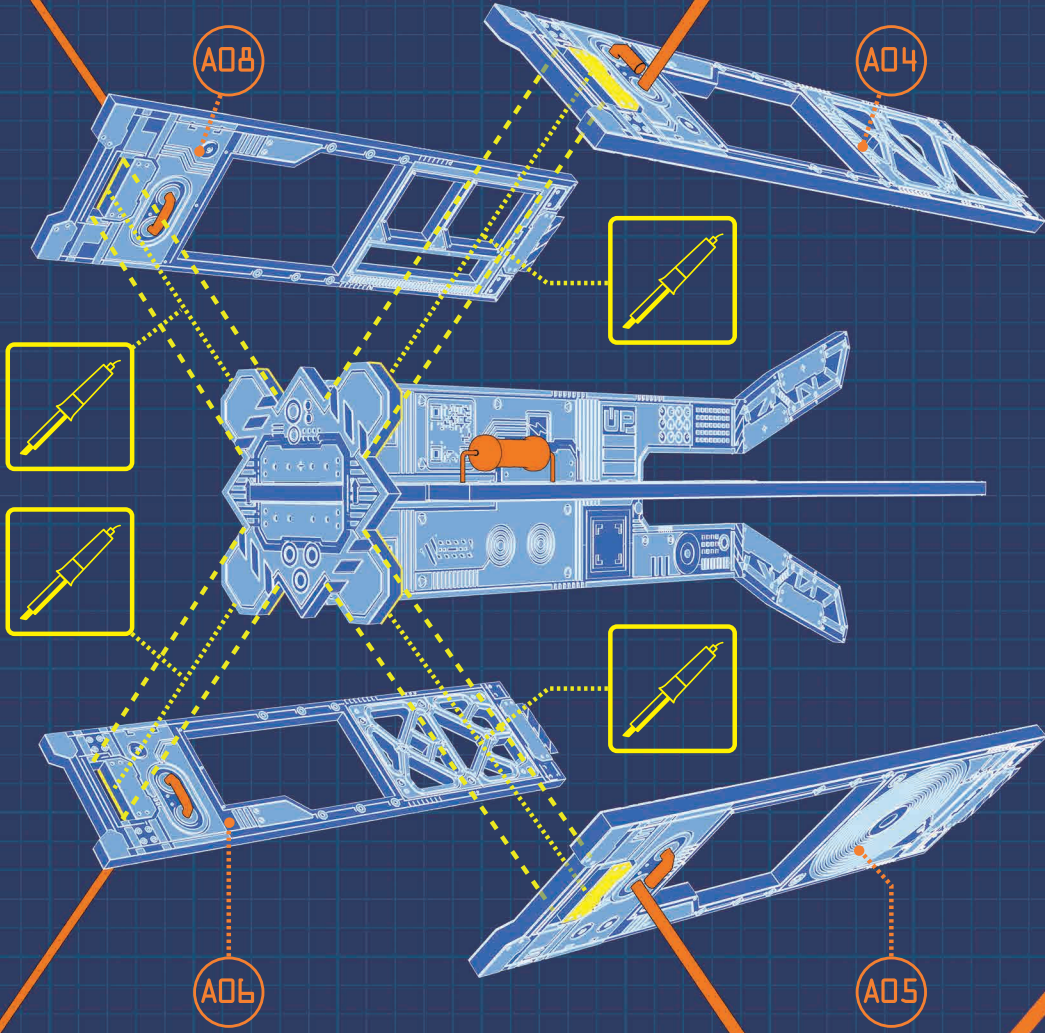

A03

A04

A06

A05

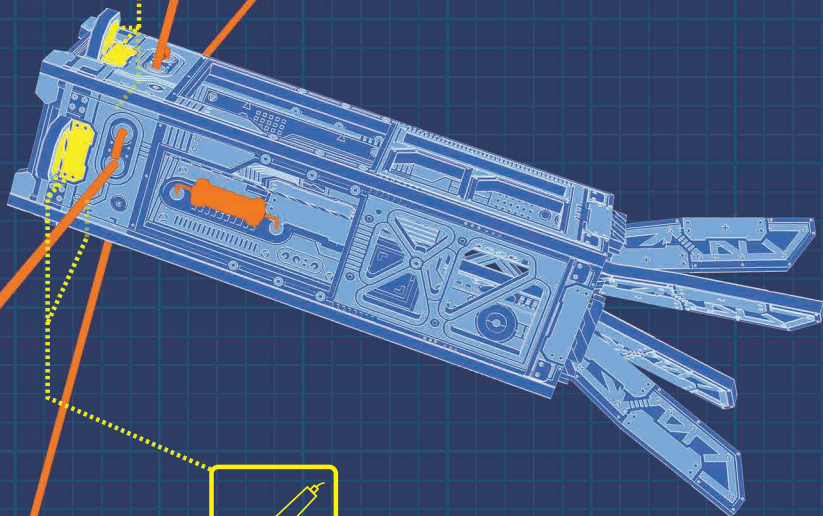

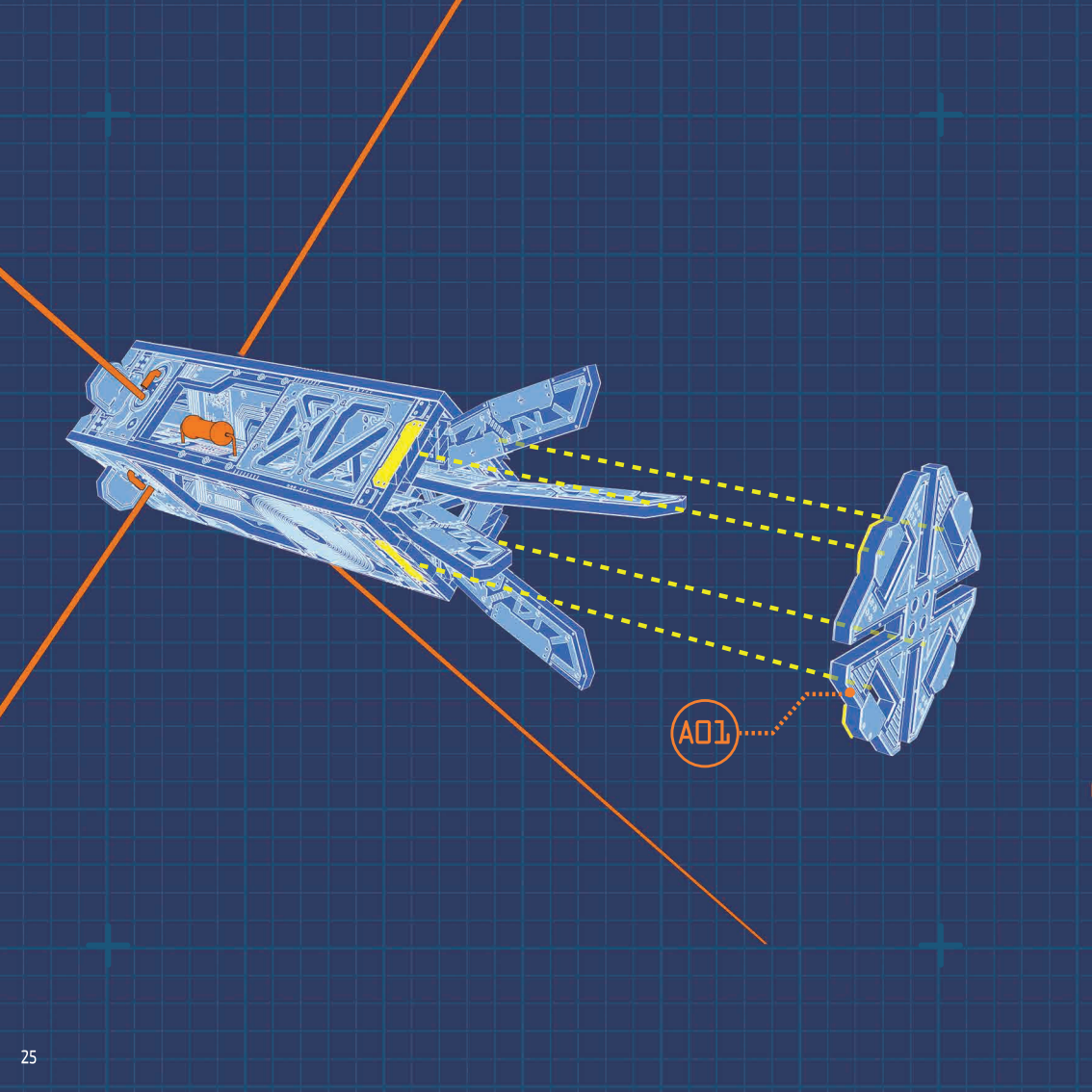

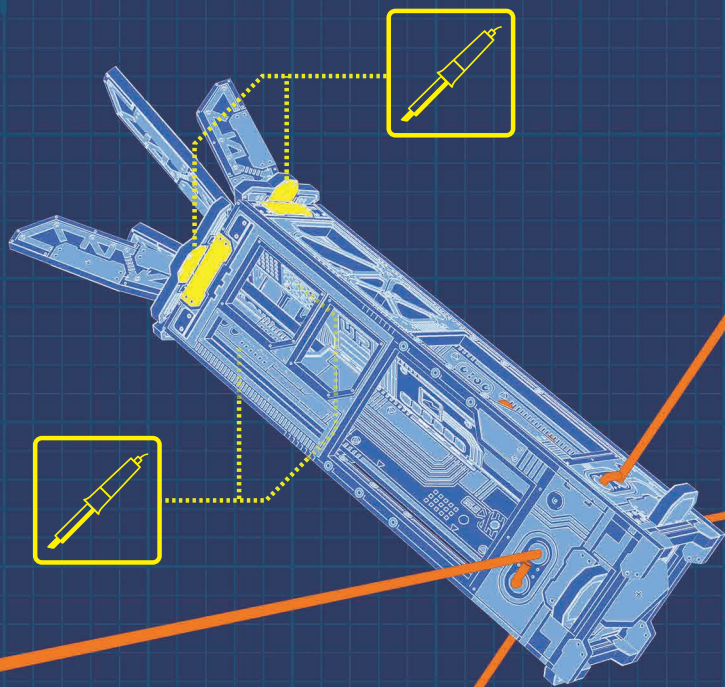

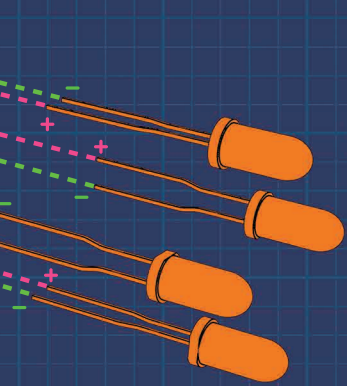
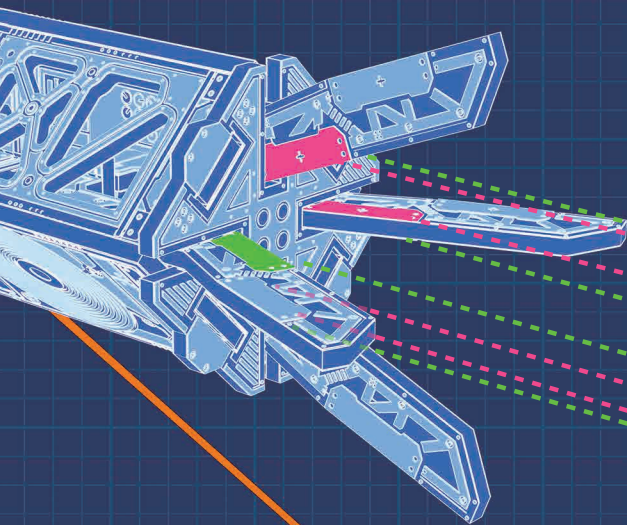

x4

LED TH 3mm
Through-Hole

PURPLE

SCHEMATIC
IMAGE



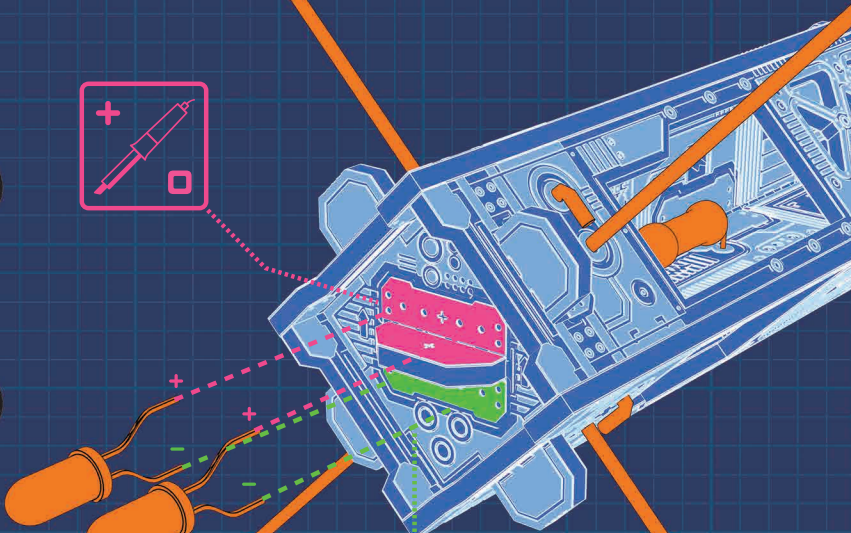
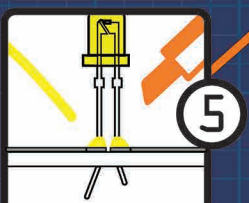
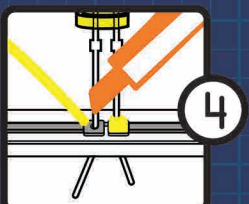
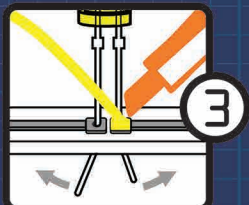
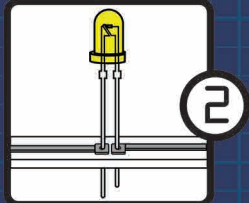
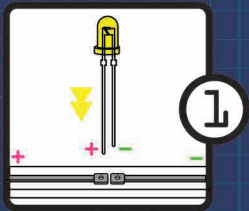

 x4

SOLAR PANEL

—

SCHEMATIC IMAGE 

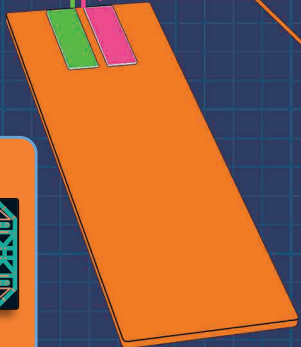
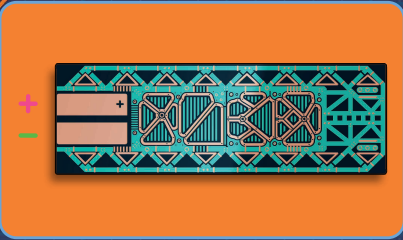
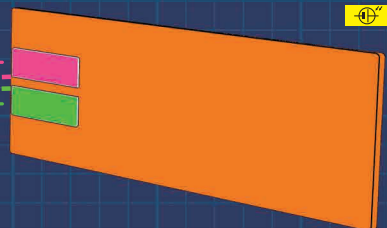
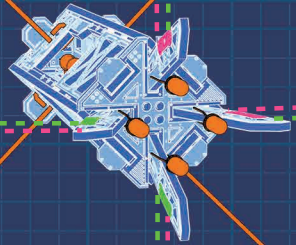
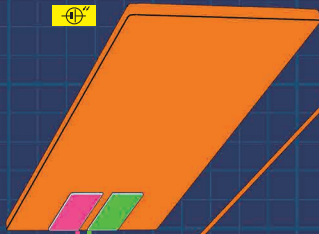

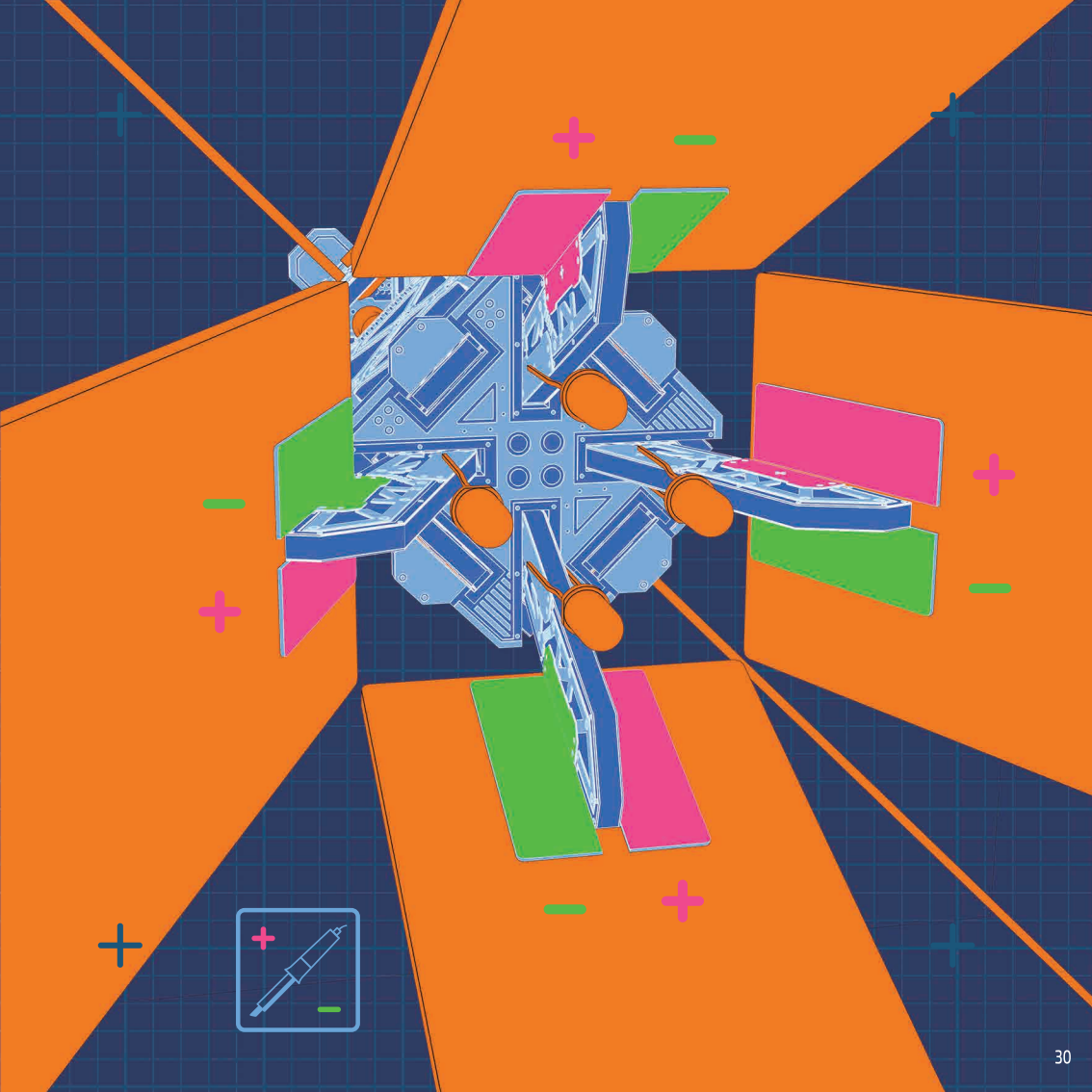

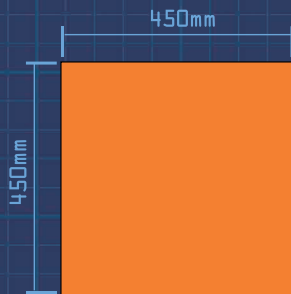

①

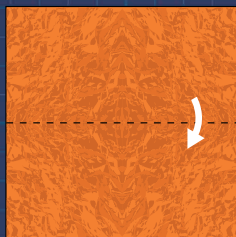
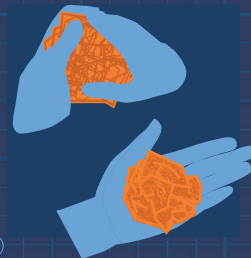

③

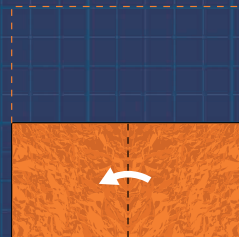

④

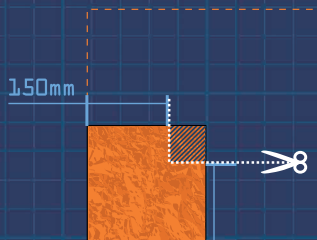

⑤

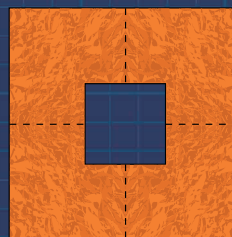

⑥

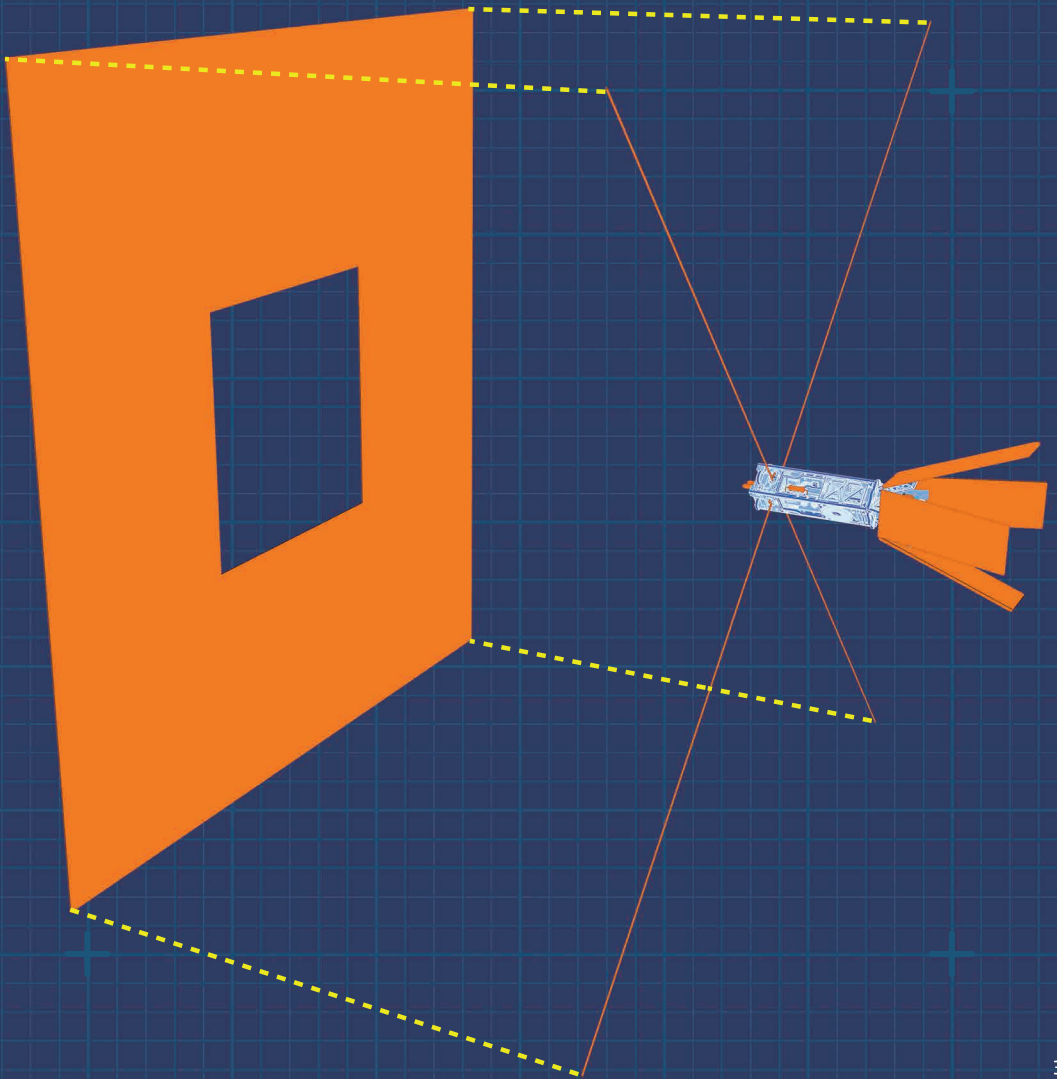

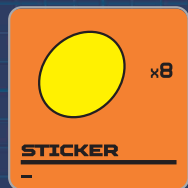
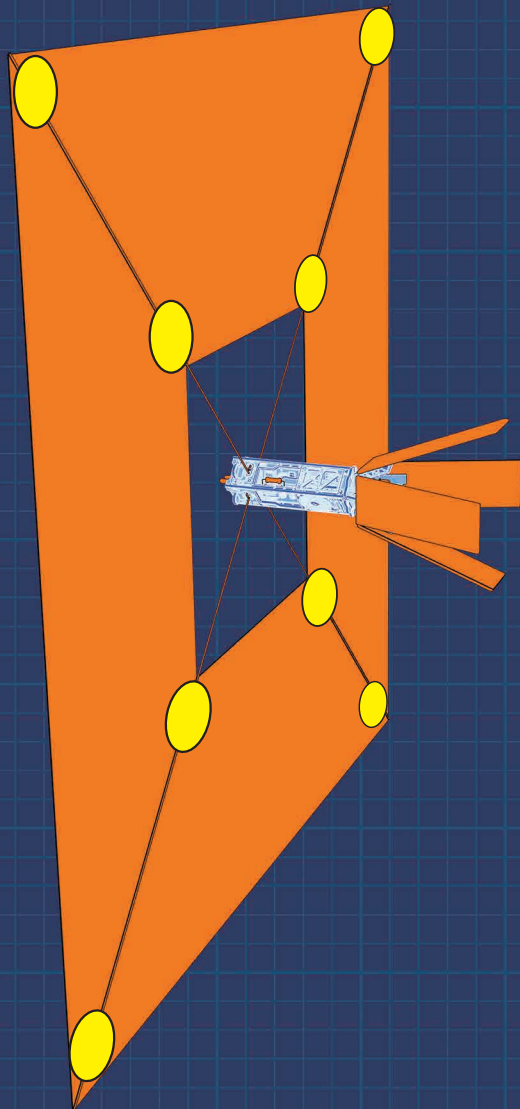

▶ KEEP SAFE

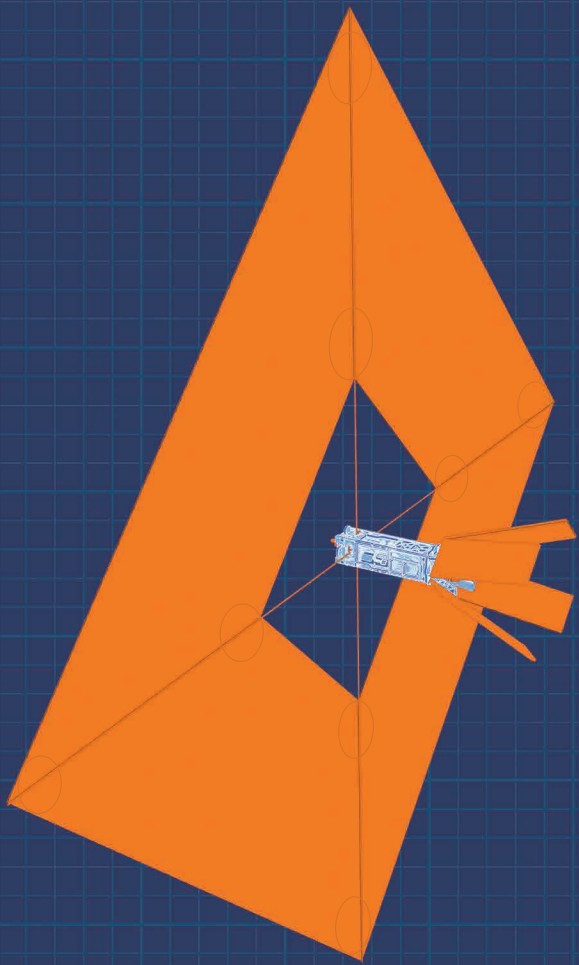

▶ KEEP SAFE

LIFT OFF

NYLON WIRE

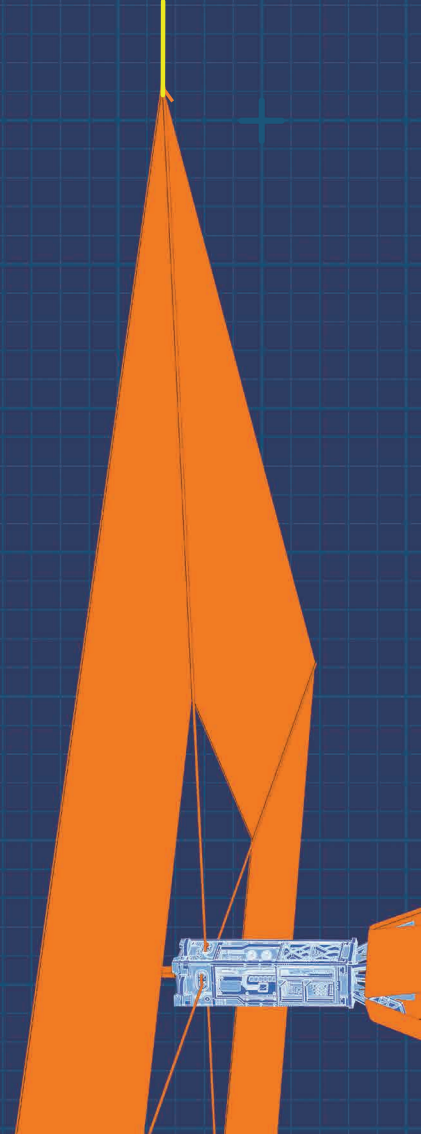
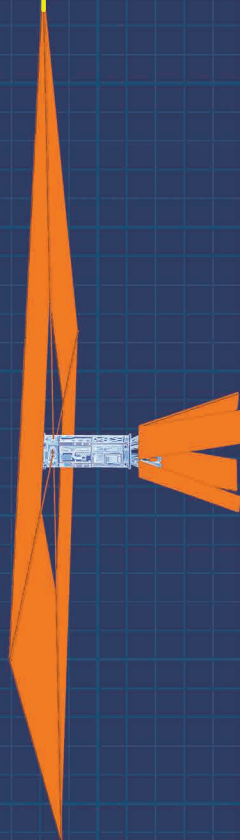



NYLON WIRE

1



2



3



METAL WIRE



NOTES

Lined area for notes with horizontal dotted lines.



Handwriting practice area with 18 horizontal dotted lines.

GEEKCLUB.COM

KEEP SAFE ◀



READ BEFORE FLIGHT

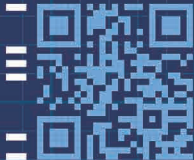

f/📷 WE.ARE.GEEKCLUB

MORE FUN STUFF ON OUR WEBSITE !!!
A QUESTION ? SOME COMMENTS ?

WWW.GEEKCLUB.COM

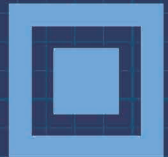

KEEP SAFE ◀