

TAG[®]



Fleet Catalogue

September 2022

TAG Towbars are designed, manufactured and tested to comply with ADR62/01 standards. Towbars are rated to the vehicle's maximum towing capacity. Failure to monitor load limits and tow ball weights can lead to serious instability of towing vehicle and caravan.

TAG Towbars are proudly manufactured in Queensland, Australia. Copyright TAG Towbar 2022. All Rights Reserved. BRINK is a registered trade mark of Brink Towing Systems B.V. Netherlands. All Rights Reserved.

tagtowbars.com.au

Ford Ranger (09/2011 - 05/2022)

Heavy Duty Towbar Options (Class 4 50mm Square Hitch Receiver)



Styleside Ute

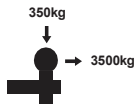

T7F704

- 3-Piece Design
- Factory Mounting Points for ease of fitment
- Durable Powder Coated Finish
- Class 4, 50mm x 50mm Hitch Receiver
- TAG Limited Lifetime Warranty
- Includes Tow Ball Mount, Tow Ball, Pin & Clip and D-Shackles

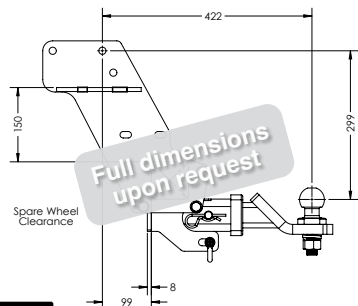

Cab Chassis

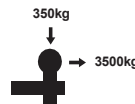

T7F705

- 3-Piece Design
- Factory Mounting Points for ease of fitment
- Durable Powder Coated Finish
- Class 4, 50mm x 50mm Hitch Receiver
- TAG Limited Lifetime Warranty
- Includes Tow Ball Mount, Tow Ball, Pin & Clip and D-Shackles

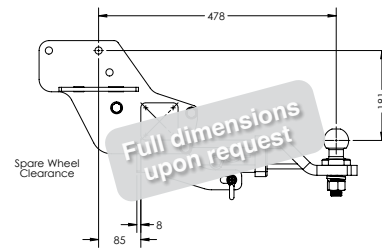

Extended Tray

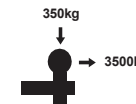

T7F706

- 3-Piece Design (Suits Extended Tray or Canopy)
- Class 4, 50mm x 50mm Hitch Receiver
- Durable Powder Coated Finish
- TAG Limited Lifetime Warranty
- Includes Tow Ball Mount, Tow Ball, Pin & Clip and D-Shackles

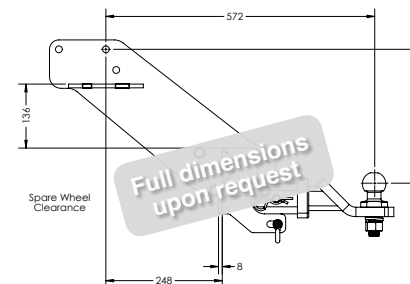

4x4 Recovery Cab Chassis

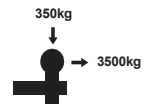

TXR804

- 89mm x 89mm Extreme Duty Reinforced Crossbar
- Two WLL 4500kg Load-Rated Recovery Points
- Maximum clearance for departure angles.
- Textured Extreme Duty Powder Coated Finish
- Dual top-mounted Trailer & Andersen Plug Mounts
- TAG Limited Lifetime Warranty
- Includes Zinc Tow Ball & Extreme Duty Drop Hitch, Pin & Clip and D-Shackles

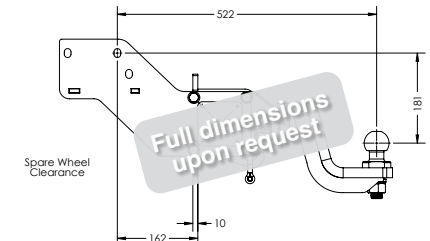

Ford Ranger Next-Gen (06/2022 - on)

Heavy Duty Towbar Options (Class 4 50mm Square Hitch Receiver)



Style Side Ute

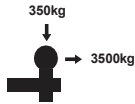

T7F838

- 3-Piece Design
- Factory Mounting Points for ease of fitment
- Durable Powder Coated Finish
- Class 4, 50mm x 50mm Hitch Receiver
- TAG Limited Lifetime Warranty
- Includes Tow Ball Mount, Tow Ball, Pin & Clip and D-Shackles

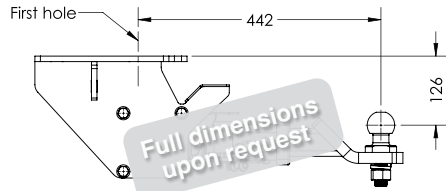

Full dimensions upon request



Cab Chassis

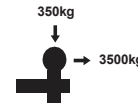

T7F841

- 3-Piece Design
- Factory Mounting Points for ease of fitment
- Durable Powder Coated Finish
- Class 4, 50mm x 50mm Hitch Receiver
- TAG Limited Lifetime Warranty
- Includes Tow Ball Mount, Tow Ball, Pin & Clip and D-Shackles

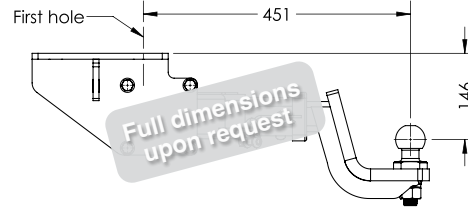

Full dimensions upon request



Extended Tray

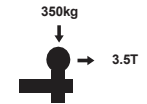

T7F840

- 3-Piece Design (Suits Extended Tray or Canopy)
- Class 4, 50mm x 50mm Hitch Receiver
- Durable Powder Coated Finish
- TAG Limited Lifetime Warranty
- Includes Tow Ball Mount, Tow Ball, Pin & Clip and D-Shackles

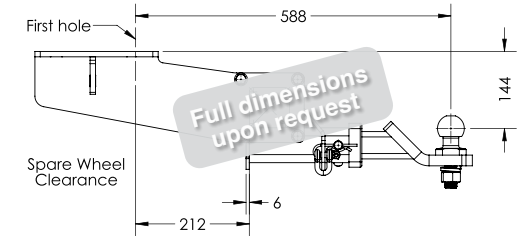

Full dimensions upon request



Ford Ranger Next-Gen (06/2022 - on)

4x4 Recovery Towbar Options



4x4 Recovery Cab Chassis

TXR836

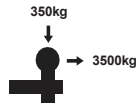

- 89mm x 89mm Extreme Duty Reinforced Crossbar
- Two WLL 4500kg Load-Rated Recovery Points
- Maximum clearance for departure angles.
- Textured Extreme Duty Powder Coated Finish
- Dual top-mounted Trailer & Andersen Plug Mounts
- TAG Limited Lifetime Warranty
- Includes Zinc Tow Ball & Extreme Duty Drop Hitch, Pin & Clip and D-Shackles

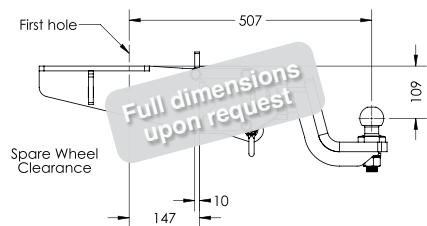

4x4 Recovery Cab Chassis

TXR843

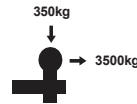

- 89mm x 89mm Extreme Duty Reinforced Crossbar
- Two WLL 4500kg Load-Rated Recovery Points
- Maximum clearance for departure angles.
- Textured Extreme Duty Powder Coated Finish
- Dual top-mounted Trailer & Andersen Plug Mounts
- TAG Limited Lifetime Warranty
- Includes Zinc Tow Ball & Extreme Duty Drop Hitch, Pin & Clip and D-Shackles

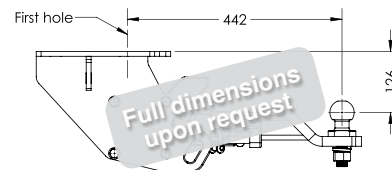

Volkswagen Amarok (09/2011 - on)

Heavy Duty Towbar Options (Class 4 50mm Square Hitch Receiver)



Styleside Ute

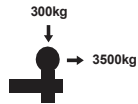

T7P673

- 3-Piece Design
- Factory Mounting Points for ease of fitment
- Durable Powder Coated Finish
- Class 4, 50mm x 50mm Hitch Receiver
- TAG Limited Lifetime Warranty
- Includes Zinc Tow Ball & Extreme Duty Drop Hitch, Pin & Clip and D-Shackles



4x4 Recovery Cab Chassis

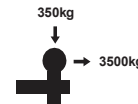

TXR807

- 89mm x 89mm Extreme Duty Reinforced Crossbar
- Two WLL 4500kg Load-Rated Recovery Points
- Maximum clearance for departure angles.
- Textured Extreme Duty Powder Coated Finish
- Dual top-mounted Trailer & Andersen Plug Mounts
- TAG Limited Lifetime Warranty
- Includes Zinc Tow Ball & Extreme Duty Drop Hitch, Pin & Clip and D-Shackles

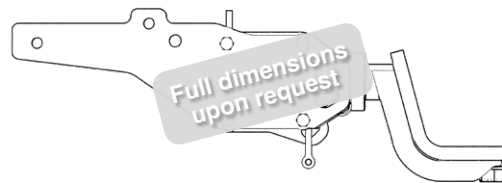

Isuzu D-MAX (07/2020 - on)

Heavy Duty Towbar Options (Class 4 50mm Square Hitch Receiver)



Styleside Ute/Cab Chassis

T7H765

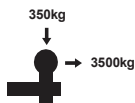

- 3-Piece Design
- Factory Mounting Points for ease of fitment
- Durable Powder Coated Finish
- Class 4, 50mm x 50mm Hitch Receiver
- TAG Limited Lifetime Warranty
- Includes Tow Ball Mount, Tow Ball, Pin & Clip and D-Shackles

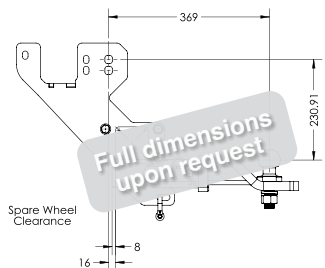

Extended Tray

T7H770

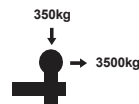

- 3-Piece Design (Suits Extended Tray or Canopy)
- Class 4, 50mm x 50mm Hitch Receiver
- Durable Powder Coated Finish
- TAG Limited Lifetime Warranty
- Includes Tow Ball Mount, Tow Ball, Pin & Clip and D-Shackles

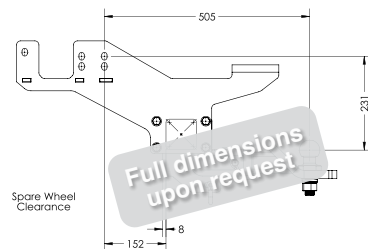

4x4 Recovery Cab Chassis

TXR800

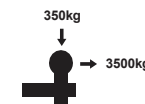

- 89mm x 89mm Extreme Duty Reinforced Crossbar
- Two WLL 4500kg Load-Rated Recovery Points
- Maximum clearance for departure angles.
- Textured Extreme Duty Powder Coated Finish
- Dual top-mounted Trailer & Andersen Plug Mounts
- TAG Limited Lifetime Warranty
- Includes Zinc Tow Ball & Extreme Duty Drop Hitch, Pin & Clip and D-Shackles

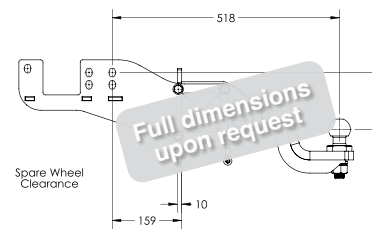

4x4 Recovery Styleside

TXR822

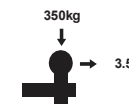

- Two WLL 4500kg Load-Rated Recovery Points
- Maximum clearance for departure angles.
- Textured Extreme Duty Powder Coated Finish
- TAG Limited Lifetime Warranty
- Includes Zinc Tow Ball & Extreme Duty Drop Hitch, Pin & Clip and D-Shackles

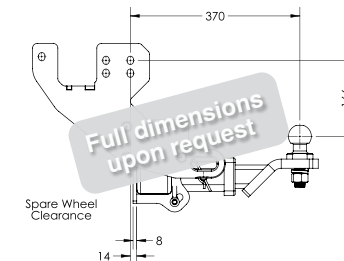

Mazda BT-50 (08/2020 - on)

Heavy Duty Towbar Options (Class 4 50mm Square Hitch Receiver)



Styleside Ute/Cab Chassis

T7H765

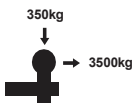

- 3-Piece Design
- Factory Mounting Points for ease of fitment
- Durable Powder Coated Finish
- Class 4, 50mm x 50mm Hitch Receiver
- TAG Limited Lifetime Warranty
- Includes Tow Ball Mount, Tow Ball, Pin & Clip and D-Shackles

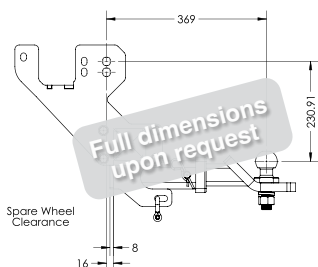

Extended Tray

T7H770

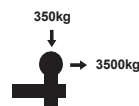

- 3-Piece Design (Suits Extended Tray or Canopy)
- Class 4, 50mm x 50mm Hitch Receiver
- Durable Powder Coated Finish
- TAG Limited Lifetime Warranty
- Includes Tow Ball Mount, Tow Ball, Pin & Clip and D-Shackles

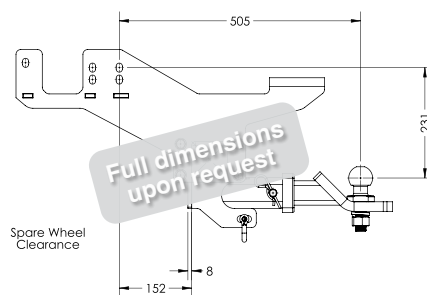

4x4 Recovery Cab Chassis

TXR800

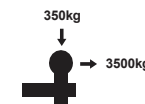

- 89mm x 89mm Extreme Duty Reinforced Crossbar
- Two WLL 4500kg Load-Rated Recovery Points
- Maximum clearance for departure angles.
- Textured Extreme Duty Powder Coated Finish
- Dual top-mounted Trailer & Andersen Plug Mounts
- TAG Limited Lifetime Warranty
- Includes Zinc Tow Ball & Extreme Duty Drop Hitch, Pin & Clip and D-Shackles

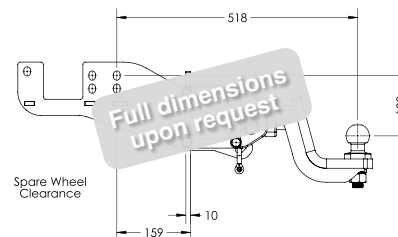

4x4 Recovery Styleside

TXR822

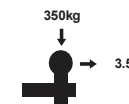

- 89mm x 89mm Extreme Duty Reinforced Crossbar
- Two WLL 4500kg Load-Rated Recovery Points
- Maximum clearance for departure angles.
- Textured Extreme Duty Powder Coated Finish
- Dual top-mounted Trailer & Andersen Plug Mounts
- TAG Limited Lifetime Warranty
- Includes Zinc Tow Ball & Extreme Duty Drop Hitch, Pin & Clip and D-Shackles

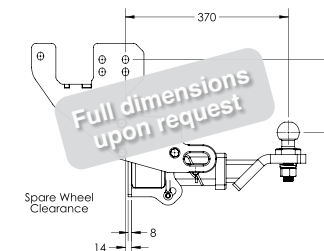

Isuzu MU-X (06/21 - on)

Heavy Duty Towbar Options (Class 4 50mm Square Hitch Receiver)



MU-X

T7H808

- 3-Piece Design
- Factory Mounting Points for ease of fitment
- Durable Powder Coated Finish
- Class 4, 50mm x 50mm Hitch Receiver
- TAG Limited Lifetime Warranty
- Includes Tow Ball Mount, Tow Ball, Pin & Clip and D-Shackles

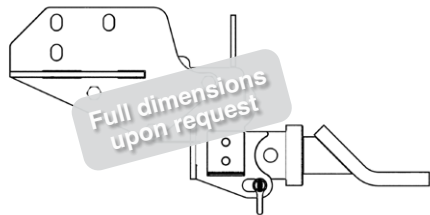
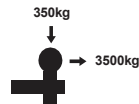

TAG HD

4x4 Recovery Cab Chassis

TXR832

- 89mm x 89mm Extreme Duty Reinforced Crossbar
- Two WLL 4500kg Load-Rated Recovery Points
- Maximum clearance for departure angles.
- Textured Extreme Duty Powder Coated Finish
- Dual Trailer & Andersen Plug Mounts
- TAG Limited Lifetime Warranty
- Includes Zinc Tow Ball & Extreme Duty Drop Hitch, Pin & Clip and D-Shackles

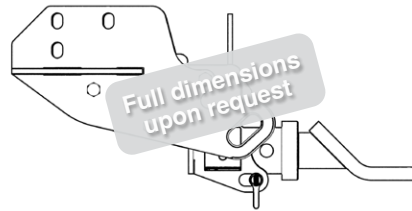
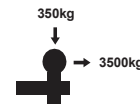

TAG XR

Toyota Hilux (2015 - on)

Heavy Duty Towbar Options (Class 4 50mm Square Hitch Receiver)



Styleside Ute/Cab Chassis No Bumper

T7T701

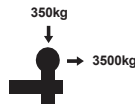

- 3-Piece Design
- Factory Mounting Points for ease of fitment
- Durable Powder Coated Finish
- Class 4, 50mm x 50mm Hitch Receiver
- TAG Limited Lifetime Warranty
- Includes Tow Ball Mount, Tow Ball, Pin & Clip and D-Shackles

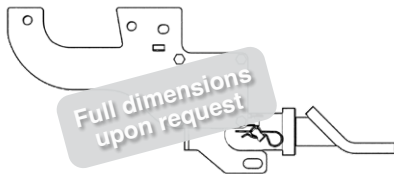

Extended Tray

T7T703

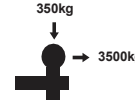

- 3-Piece Design (Suits Extended Tray or Canopy)
- Class 4, 50mm x 50mm Hitch Receiver
- Durable Powder Coated Finish
- TAG Limited Lifetime Warranty
- Includes Tow Ball Mount, Tow Ball, Pin & Clip and D-Shackles

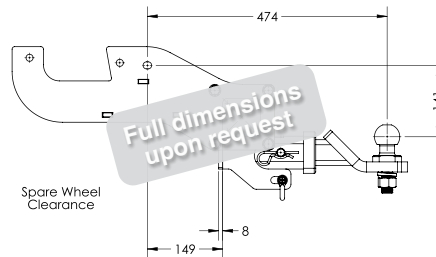

Styleside Ute

T7T715

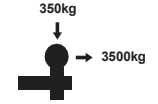

- 3-Piece Design
- Factory Mounting Points for ease of fitment
- Durable Powder Coated Finish
- Class 4, 50mm x 50mm Hitch Receiver
- TAG Limited Lifetime Warranty
- Includes Tow Ball Mount, Tow Ball, Pin & Clip and D-Shackles

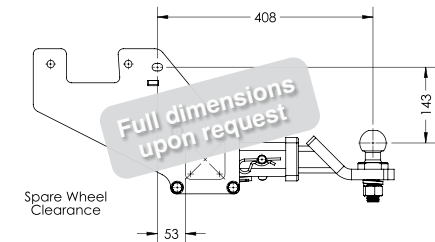

Toyota Hilux (2015 - on)

4x4 Recovery Towbar Options



4x4 Recovery Cab Chassis

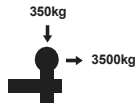

TXR783

- 89mm x 89mm Extreme Duty Reinforced Crossbar
- Two WLL 4500kg Load-Rated Recovery Points
- Maximum clearance for departure angles.
- Textured Extreme Duty Powder Coated Finish
- Dual top-mounted Trailer & Andersen Plug Mounts
- TAG Limited Lifetime Warranty
- Includes Tow Ball Mount, Tow Ball, Pin & Clip and D-Shackles

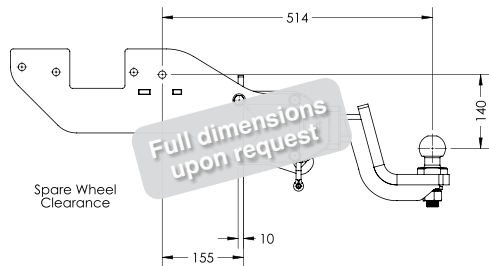

4x4 Recovery Styleside

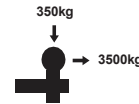

TXR819

- 89mm x 89mm Extreme Duty Reinforced Crossbar
- Two WLL 4500kg Load-Rated Recovery Points
- Maximum clearance for departure angles.
- Textured Extreme Duty Powder Coated Finish
- Dual Trailer & Andersen Plug Mounts
- TAG Limited Lifetime Warranty
- Includes Tow Ball Mount, Tow Ball, Pin & Clip and D-Shackles

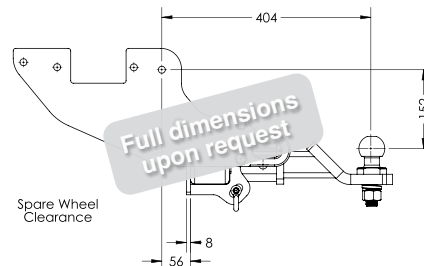

Mitsubishi Triton (05/2015 - on)

Heavy Duty Towbar Options (Class 4 50mm Square Hitch Receiver)



Styleside Ute

T7C707

- Suits Models WITH Rear Bumper/Step
- 3-Piece Design
- Factory Mounting Points for ease of fitment
- Durable Powder Coated Finish
- Class 4, 50mm x 50mm Hitch Receiver
- TAG Limited Lifetime Warranty
- Includes Tow Ball Mount, Tow Ball, Pin & Clip and D-Shackles

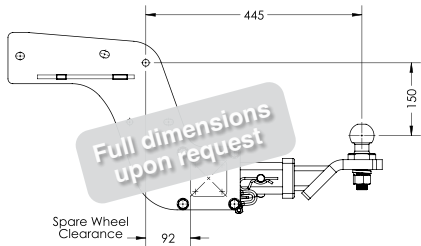
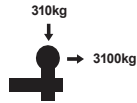

Styleside Ute / Cab Chassis No Bumper

T7C708

- Suits Models with Trayback and Styleside WITHOUT Rear Bumper/Step
- 3-Piece Design (Suits Extended Tray or Canopy)
- Class 4, 50mm x 50mm Hitch Receiver
- Durable Powder Coated Finish
- TAG Limited Lifetime Warranty
- Includes Tow Ball Mount, Tow Ball, Pin & Clip and D-Shackles

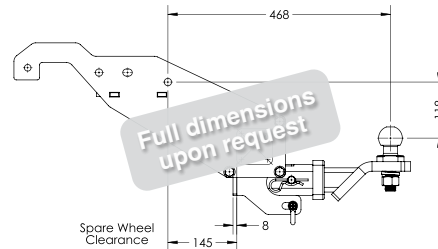
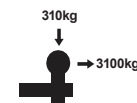

4x4 Recovery Cab Chassis

TXR805

- 89mm x 89mm Extreme Duty Reinforced Crossbar
- Two WLL 4500kg Load-Rated Recovery Points
- Maximum clearance for departure angles.
- Textured Extreme Duty Powder Coated Finish
- Dual top-mounted Trailer & Andersen Plug Mounts
- TAG Limited Lifetime Warranty
- Includes Zinc Tow Ball & Extreme Duty Drop Hitch, Pin & Clip and D-Shackles

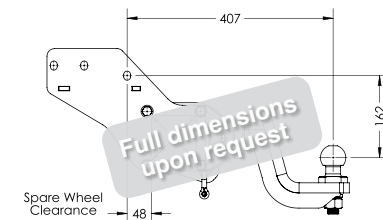
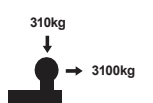

Nissan Navara (11/2015 - on)

Heavy Duty Towbar Options (Class 4 50mm Square Hitch Receiver)



Styleside Ute/Cab Chassis

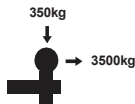

T7D788

- 3-Piece Design
- Factory Mounting Points for ease of fitment
- Durable Powder Coated Finish
- Class 4, 50mm x 50mm Hitch Receiver
- TAG Limited Lifetime Warranty
- Includes Tow Ball Mount, Tow Ball, Pin & Clip and D-Shackles

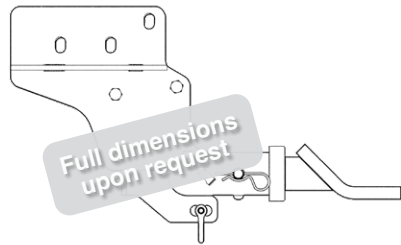

4x4 Recovery Cab Chassis

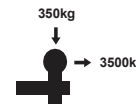

TXR806

- 89mm x 89mm Extreme Duty Reinforced Crossbar
- Two WLL 4500kg Load-Rated Recovery Points
- Maximum clearance for departure angles.
- Textured Extreme Duty Powder Coated Finish
- Dual top-mounted Trailer & Andersen Plug Mounts
- TAG Limited Lifetime Warranty
- Includes Zinc Tow Ball & Extreme Duty Drop Hitch, Pin & Clip and D-Shackles

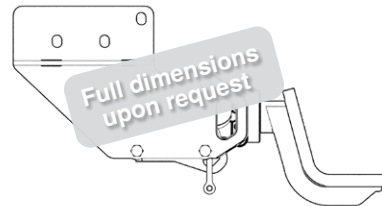

Toyota Landcruiser 79 Series (08/2012 - on)

Heavy Duty Towbar Options (Class 4 50mm Square Hitch Receiver)



Styleside Ute/Cab Chassis

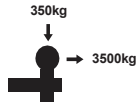

T7T699

- 3-Piece Design
- Factory Mounting Points for ease of fitment
- Durable Powder Coated Finish
- Class 4, 50mm x 50mm Hitch Receiver
- TAG Limited Lifetime Warranty
- Includes Tow Ball Mount, Tow Ball, Pin & Clip and D-Shackles

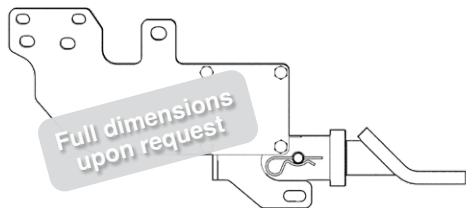

TAG HD



4x4 Recovery Cab Chassis

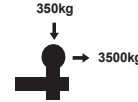

TXR793

- 89mm x 89mm Extreme Duty Reinforced Crossbar
- Two WLL 4500kg Load-Rated Recovery Points
- Maximum clearance for departure angles.
- Textured Extreme Duty Powder Coated Finish
- Dual top-mounted Trailer & Andersen Plug Mounts
- TAG Limited Lifetime Warranty
- Includes Zinc Tow Ball & Extreme Duty Drop Hitch, Pin & Clip and D-Shackles

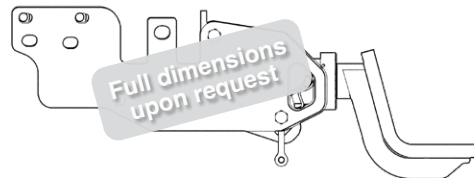

TAG XR



Mine Spec with Pintle Cab Chassis

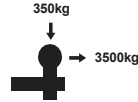

TMR812

- 89mm x 89mm Extreme Duty Reinforced Crossbar
- Two WLL 4500kg Load-Rated Recovery Points
- Maximum clearance for departure angles.
- Textured Extreme Duty Powder Coated Finish
- Dual top-mounted Trailer & Andersen Plug Mounts
- TAG Limited Lifetime Warranty
- Includes Zinc Tow Ball & Pintle, Pin & Clip and D-Shackles

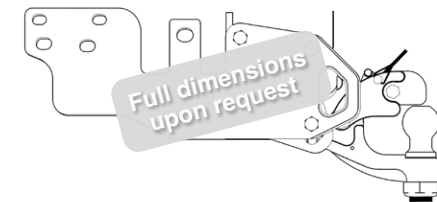

TAG MR

Toyota Prado & RAV4

Heavy Duty Towbar Options (Class 4 50mm Square Hitch Receiver)



150 Series (11/2009 - on) Spare Wheel Underneath

T7T728

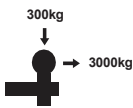

- 3-Piece Design
- Factory Mounting Points for ease of fitment
- Durable Powder Coated Finish
- Class 4, 50mm x 50mm Hitch Receiver
- TAG Limited Lifetime Warranty
- Includes Tow Ball Mount, Tow Ball, Pin & Clip and D-Shackles



Prado (09/2002 - on)

T7T729

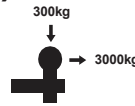

- 3-Piece Design
- Factory Mounting Points for ease of fitment
- Durable Powder Coated Finish
- Class 4, 50mm x 50mm Hitch Receiver
- TAG Limited Lifetime Warranty
- Includes Tow Ball Mount, Tow Ball, Pin & Clip and D-Shackles

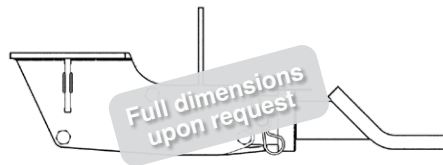

Prado (09/2002 - on) 4x4 Recovery

TXR818

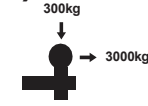

- Factory Mounting Points for ease of fitment
- Two WLL 4500kg Load-Rated Recovery Points
- Textured Extreme Duty Powder Coated Finish
- Dual top-mounted Trailer & Andersen Plug Mounts
- Class 4, 50mm x 50mm Hitch Receiver
- TAG Limited Lifetime Warranty
- Includes Tow Ball Mount, Tow Ball, Pin & Clip and D-Shackles

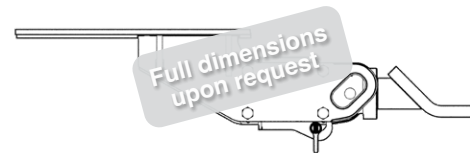

RAV4 (01/2019 - on)

T7T798

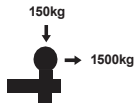

- 3-Piece Design
- Factory Mounting Points for ease of fitment
- Durable Powder Coated Finish
- Class 4, 50mm x 50mm Hitch Receiver
- TAG Limited Lifetime Warranty
- Includes Tow Ball Mount, Tow Ball, Pin & Clip and D-Shackles

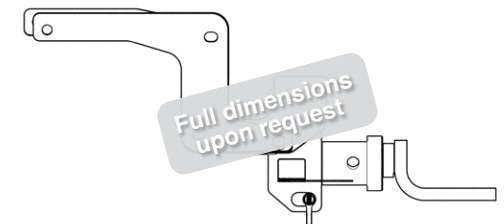

Hyundai iLoad (01/2008 - 06/2021)

Heavy Duty Towbar & Rear Step Options



Class 4 Towbar

T7Z726

- 3-Piece Design
- Factory Mounting Points for ease of fitment
- Durable Powder Coated Finish
- Class 4, 50mm x 50mm Hitch Receiver
- TAG Limited Lifetime Warranty
- Includes Tow Ball Mount, Tow Ball, Pin & Clip and D-Shackles

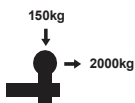

Towbar & Rear Step

T7Z737

- 3-Piece Design
- Factory Mounting Points for ease of fitment
- Durable Powder Coated Finish
- Class 4, 50mm x 50mm Hitch Receiver
- TAG Limited Lifetime Warranty
- Includes Tow Ball Mount, Tow Ball, Pin & Clip and D-Shackles

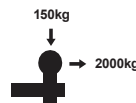

Rear Step

TSZ745

- Bolt-on Galvanised Rear Step
- Heavy-Duty Powder-Coated Brackets
- 250kg Static Load Rating
- TAG Limited Lifetime Warranty

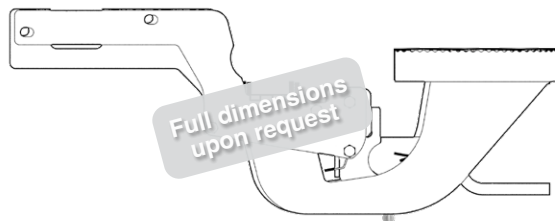
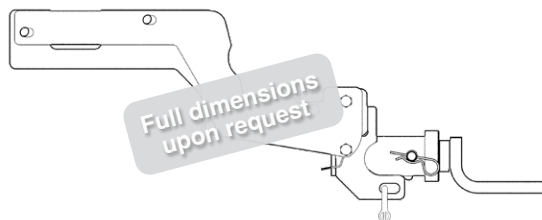

Reverse Sensor Brackets

RSM005



Hyundai Staria (06/2021 - on)

Heavy Duty Towbar & Rear Step Options

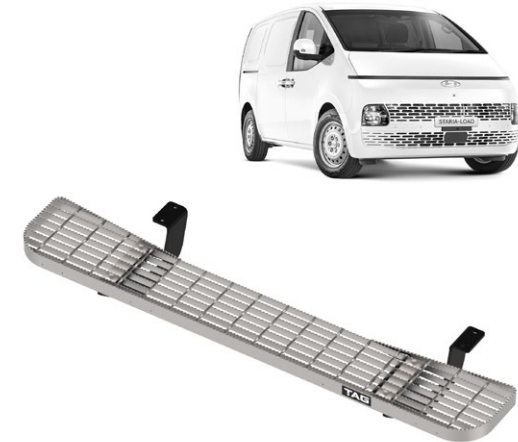

Class 4 Towbar

T7Z828

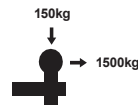

- 3-Piece Design
- Factory Mounting Points for ease of fitment
- Durable Powder Coated Finish
- Class 4, 50mm x 50mm Hitch Receiver
- TAG Limited Lifetime Warranty
- Includes Tow Ball Mount, Pin & Clip and D-Shackles

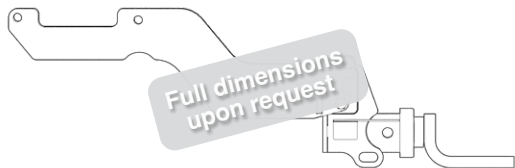

Towbar & Rear Step

T7Z829

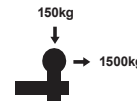

- 3-Piece Design
- Factory Mounting Points for ease of fitment
- Durable Powder Coated Finish
- Class 4, 50mm x 50mm Hitch Receiver
- TAG Limited Lifetime Warranty
- Includes Tow Ball Mount, Tow Ball, Pin & Clip and D-Shackles

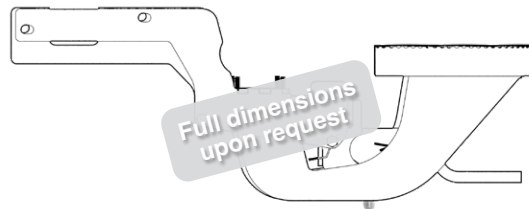

Rear Step

TSZ830

- Bolt-on Galvanised Rear Step
- Heavy-Duty Powder-Coated Brackets
- 250kg Static Load Rating
- TAG Limited Lifetime Warranty

Reverse Sensor Brackets

RSM009



Toyota Hiace (02/2019 - on)

Heavy Duty Towbar & Rear Step Options



Class 4 Towbar

T7T709

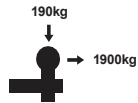

- 3-Piece Design
- Factory Mounting Points for ease of fitment
- Durable Powder Coated Finish
- Class 4, 50mm x 50mm Hitch Receiver
- TAG Limited Lifetime Warranty
- Includes Tow Ball Mount, Tow Ball, Pin & Clip and D-Shackles

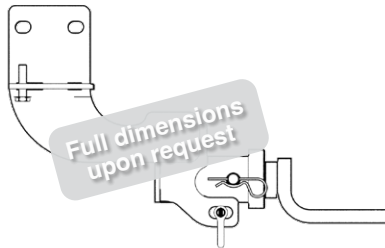

Towbar & Rear Step

T7T743

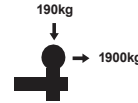

- Bolt-on Galvanised Rear Step
- Powder Coated Towbar and Brackets
- Utilises factory mounting points for ease of fitment
- Class 4 Receiver - 50mm x 50mm Hitch
- TAG Limited Lifetime Warranty
- Includes Tow Ball Mount, Tow Ball, Pin & Clip and D-Shackles

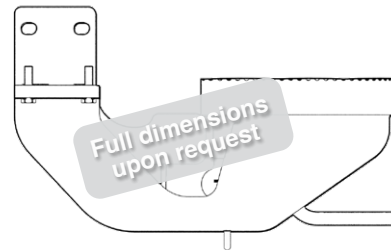

Rear Step

TST751

- Bolt-on Galvanised Rear Step
- Heavy-Duty Powder-Coated Brackets
- 250kg Static Load Rating
- TAG Limited Lifetime Warranty

Reverse Sensor Brackets

RSM003



Renault Master (09/2011 - on)

Heavy Duty Towbar Options (Class 4 50mm Square Hitch Receiver)



Class 4 Towbar

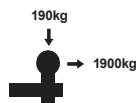

T7P724

- 3-Piece Design
- Factory Mounting Points for ease of fitment
- Durable Powder Coated Finish
- Class 4, 50mm x 50mm Hitch Receiver
- TAG Limited Lifetime Warranty
- Includes Tow Ball Mount, Pin & Clip and D-Shackles

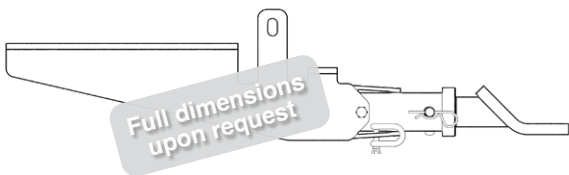

Towbar & Rear Step

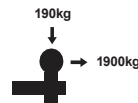

T7P739

- Bolt-on Galvanised Rear Step
- Powder Coated Towbar and Brackets
- Utilises factory mounting points for ease of fitment
- Class 4 Receiver - 50mm x 50mm Hitch
- TAG Limited Lifetime Warranty
- Includes Tow Ball Mount, Tow Ball, Pin & Clip and D-Shackles

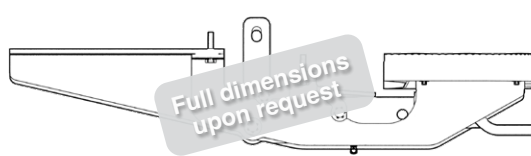

Rear Step

TSP747

- Bolt-on Galvanised Rear Step
- Heavy-Duty Powder-Coated Brackets
- 250kg Static Load Rating
- TAG Limited Lifetime Warranty

Reverse Sensor Brackets

RSM006



Suzuki Jimny (11/2018 - on)

Heavy Duty Towbar Options (Class 4 50mm Square Hitch Receiver)



4x4 Recovery

TXR817

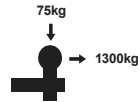

- 65mm x 65mm Extreme Duty Reinforced Crossbar
- Two WLL 2000kg Load-Rated Recovery Points
- Maximum clearance for departure angles.
- Textured Extreme Duty Powder Coated Finish
- Dual top-mounted Trailer & Andersen Plug Mounts
- TAG Limited Lifetime Warranty
- Includes Zinc Tow Ball & Extreme Duty Drop Hitch, Pin & Clip and D-Shackles

