

New Equipment Warranty

Limited Warranty

Mercury Floor Machines, Inc. warrants new equipment against defects in material and workmanship under normal use and service to the original purchaser. Any statutory implied warranties, including any warranty of merchantability or fitness for a particular purpose, are expressly limited to the duration of this written warranty. Mercury Floor Machines, Inc. will not be liable for any other damages, including but not limited to indirect or special consequential damages arising out of or in connection with the furnishing, performance, use or inability to use the machine. This remedy shall be the exclusive remedy of the purchaser. The warranty period is subject to the conditions stated below.

5 Years - Motor and Gearbox, 1 Year - Service Labor

Mercury Floor Machines, Inc. warrants electric motors and transmission gearboxes on all Mercury Floor Machines, Inc. floor machines to be free from defects in material and workmanship, under normal use and service for five (5) years to the original purchaser. Parts replaced or repaired under this warranty are warranted for the remainder of the original warranty period. Service labor charges are covered for one (1) year from the date of purchase, when performed by a Mercury Floor Machines, Inc.-authorized service provider. Freight charges to and from this service provider will be covered for ninety (90) days from the purchase date. After this ninety (90) day period, these freight charges will be paid by the equipment owner. Travel expenses are not covered.

Wear Items on all Machines

Critical Wear Items - bearings, capacitors, clutches, pulleys, rectifiers, relays, switches, wheels, tires and casters are warranted for manufacturing defects for one (1) year from the purchase date.

Normal Wear Items - belts, brushes, bumpers carbon brushes, cords, finishes, squeegees, actuating cables and gaskets are warranted for manufacturing defects for ninety (90) days from the purchase date.

All warranties of motors and associated components will be voided: if the machine is used as a floor sander; if the machine is serviced by anyone other than a Mercury Floor Machines, Inc.-authorized service provider; if the machine is mechanically modified; or if the machine is misused or abused.

The warranty starts on the purchase date by the original purchaser from an authorized Mercury Floor Machines, Inc. distributor, subject to proof of purchase. The machine registration card must be completed and returned immediately at the time of purchase. If proof of purchase cannot be identified, the warranty start date is ninety (90) days after the date of sale to an authorized Mercury Floor Machines, Inc. inventory.



Mercury Floor Machines, Inc.

110 South Van Brunt Street
Englewood, NJ 07631

Phone: 201-568-4606
Toll Free: 888-568-4606

www.mercuryfloormachines.com

Make a copy of this card for future reference.

© 2013 All Rights Reserved Mercury Floor Machines, Inc.

BOSS-I FLOOR MACHINE

SAFETY, OPERATION AND MAINTENANCE MANUAL WITH PARTS LIST

Please read before use!

175 RPM, 1.5 HP

REGISTER
YOUR
MACHINE
ONLINE!



Five
Interchangeable
Aprons Available:
13", 15", 17", 19"
and 21"

Model BOSS-I

Heavy-Duty

Safe & Easy to Use

Fully Adjustable

Powerful Motor

Super Value

Three Apron Sizes



IMPORTANT INFORMATION AND SAFETY INSTRUCTIONS

Register your Machine at mercuryfloormachines.com/registration.aspx
Serial No: _____



Dear Valued Customer,

Congratulations on the purchase of your BOSS-I Floor Machine! The world of floor care is becoming more high-tech and competitive and we strive to provide you with the most innovative products. Our BOSS-I machine is yet another example of this, bringing a new dimension to floor care and maintenance with its cutting-edge features, quality and value.

Please review this manual paying careful attention to the Safety Instructions section. Keep in mind that any unnecessary damage, neglect or abuse of this machine will void your warranty. You can be confident that simple maintenance will ensure that your Floor Machine provides quality performance for many years to come.

If warranty questions arise, please consult your manual or contact your distributor. Should you have any questions regarding maintenance, replacing parts or ordering parts, please call an authorized distributor.

Before you begin using your Floor Machine, thoroughly review the Owner's Manual.

Again, congratulations on the purchase of your BOSS-I Floor Machine!

Questions or Comments?

Phone: 201-568-4606

Toll Free: 888-568-4606

Fax: 201-568-7962

info@mercuryfloormachines.com

Mailing Address:

110 South Van Brunt Street, Englewood, NJ 07631

Visit our Web site at www.mercuryfloormachines.com

Register your Machine at www.mercuryfloormachines.com/registration.aspx

(2) BOSS-I Floor Machine



Warranty Registration

Please take a moment to register your machine. Fill out the information below and mail back to Mercury immediately.

The warranty starts on the purchase date by the original purchaser, subject to proof of purchase. Please immediately register your machine online at www.mercuryfloormachines.com/registration.aspx or return this Machine Registration Card at the time of purchase. If proof of purchase cannot be identified, the warranty start date is ninety (90) days after the inventory stocking date at the distributor's warehouse.

Machine Model _____ Purchase Date _____

Motor Type _____ Serial No. _____

Place of Purchase _____

Shipped To _____

Your Name _____ Phone _____

E-mail _____ Fax _____

Address Line 1 _____

Address Line 2 _____

City _____ State _____ Zip _____

Comments:

Mail to:
Mercury Floor Machines, Inc.
110 South Van Brunt Street
Englewood, NJ 07631

**See reverse side for warranty information.
Make a copy of this card for future reference.**

© 2013 All Rights Reserved Mercury Floor Machines, Inc.

BOSS-I FLOOR MACHINE

By Mercury Floor Machines

Please fill out the following information:

Model No: _____

Serial No: _____

Distributor Name: _____

Distributor Phone No: _____

Date of Purchase: _____



Table of Contents

New Equipment Warranty.....	4
1.0 Safety Instructions	5
2.0 Grounding Instructions	6
3.0 Assembly Instructions.....	7
4.0 Operating Tips.....	9
5.0 Trouble Shooting Guide.....	10
6.0 Brush Construction	11
7.0 Machine Schematic Drawing.....	13
8.0 Machine Parts List	14



110 South Van Brunt Street, Englewood, NJ 07631

Phone: 201-568-4606 | Toll Free: 888-568-4606 | Fax: 201-568-7962

info@mercuryfloormachines.com | www.mercuryfloormachines.com

New Equipment Warranty

5-year warranty on motor and gearbox. 1-year warranty on service labor.

Mercury Floor Machines, Inc. warrants electric motors and transmission gearboxes on all Mercury Floor Machines, Inc. floor machines to be free from defects in material and workmanship, under normal use and service for five (5) years to the original purchaser. Parts replaced or repaired under this warranty are warranted for the remainder of the original warranty period. Service labor charges are covered for one (1) year from the date of purchase, when performed by a Mercury Floor Machines, Inc.-authorized service provider. Freight charges to and from this service provider will be covered for ninety (90) days from the purchase date. After this ninety (90) day period, these freight charges will be paid by the equipment owner. Travel expenses are not covered.

Wear Items on all Machines

Critical Wear Items - bearings, capacitors, clutches, pulleys, rectifiers, relays, switches, wheels, tires and casters are warranted for manufacturing defects for one (1) year from the purchase date.

Normal Wear Items - belts, brushes, bumpers carbon brushes, cords, finishes, squeegees, actuating cables and gaskets are warranted for manufacturing defects for ninety (90) days from the purchase date.

All warranties of motors and associated components will be voided: if the machine is used as a floor sander; if the machine is serviced by anyone other than a Mercury Floor Machines, Inc.-authorized service provider; if the machine is mechanically modified; or if the machine is misused or abused.

Warranty Policy

All equipment is inspected and tested before shipping from the manufacturer. All parts are warranted to be new and free from defects in workmanship and material, under normal use to the original retail purchaser. This warranty limits manufacturer's liability for defects in workmanship or materials for replacement of defective parts only. Manufacturer accepts no liability for incidental or consequential damages arisen from the use of any equipment, defective or not. This warranty is in lieu of all expressed or implied warranties and is extended only to the original retail purchaser. Manufacturer sales and service representatives are not authorized to waive or alter the terms of this warranty, or to increase the obligations of the manufacturer under the warranty. Parts replaced or repaired under warranty are warranted for the remainder of the original warranty period.

Freight charges and travel charges to and from the service provider shall be covered for ninety (90) days from the original purchase date. After this ninety (90) day period, freight charges shall be paid by the equipment owner, subject to manufacturer discretion. Certain circumstances may require additional consideration. No travel charges shall be covered after ninety (90) days.

Manufacturer covers up to 1-year (365 days) of service labor at manufacturer's calculated hourly labor rate/repair time when performed by a manufacturer's authorized-service provider. Ultimately, labor reimbursement costs are at the discretion of the manufacturer. After 1-year, the original retail purchaser is responsible for all labor costs with no manufacturer reimbursement.

Manufacturer charges a 15% restocking fee for any items that are being returned to stock. Items must be new, unused and free of damage. Only good for up to 1-year (365 days). After 1-year, manufacturer does not accept the return of any item(s) for a reimbursed price. Authorized warranty replacement parts need to come directly from the manufacturer. Use of any other parts will void warranty. Manufacturer does not reimburse for parts used by the customer that were not supplied directly for the machine under warranty.

Notes:

1.0 Safety Instructions

READ THIS MANUAL BEFORE USING FLOOR MACHINE. KNOW THE PROPER OPERATION, CORRECT APPLICATIONS AND THE LIMITATIONS OF THIS EQUIPMENT **BEFORE** USE.

Reduce the Risk of Fire, Electric Shock or Injury:

- This floor machine is designed for indoor use only. Do not use outdoors. Do not expose to rain.
- Do not wash the motor with flowing water. If the motor gets wet, seek authorized service.
- Keep the vents on this air-cooled motor free from debris. Do not operate with the motor covered or with vents blocked. Do not use this machine as a floor sander.
- Never operate this floor machine near flammable dusts, liquids or vapors. Never use flammable solvents as a cleaning agent. Engine sparks and operating heat can cause fire.
- Never handle electrical equipment with wet hands. Never operate this floor machine with bare feet.
- Unplug the floor machine when not in use and when servicing the equipment. To unplug, grasp the plug not the cord.
- Do not operate a floor machine with damaged handle controls, cord or plug. If the equipment is not performing properly, seek repair from a qualified service supplier.
- This floor machine is constructed with electrical grounding at the plug. Operate only when connected to a properly grounded outlet. See section 1.2 for grounding details.
- Prevent electrical cord abuse. Do not close a door upon the cord, drive equipment over it, or run the floor machine over it. Do not expose the cord to hot surfaces. Do not lift, pull or carry this floor machine by the cord.
- Never operate the floor machine over sharp objects that can be thrown out and harm the operator and damage the floor. Sweep hard floors before scrubbing or buffing. Vacuum clean carpets before shampooing or bonnet cleaning.
- Train your staff in proper use of this floor machine.



2.0 Grounding Instructions

DANGER: IMPROPER GROUNDING METHOD CAN RESULT IN A RISK OF ELECTRIC SHOCK.

Electrical equipment must be grounded. If it should malfunction or breakdown, grounding provides a path of least resistance for electrical current and reduces the risk of electric shock. The vacuum is equipped with a cord containing a grounding conductor and grounding plug. The plug must be inserted into an appropriate outlet that is properly installed and grounded in accordance with all local codes and ordinances.

If repair or replacement of the cord or plug is necessary, **DO NOT** connect the grounded wire to a flat bed terminal. The green insulated wire, with or without yellow stripes, is the grounding wire.

This floor machine operates on a 15 amp nominal 115V, 60 Hz, A.C. power circuit (motors may be custom wired at the factory 220V, 50 Hz international operation). The, amp, hertz and voltage ratings are listed on the motor spec label found on each floor machine. Using voltages above or below those indicated on the spec label will damage the motor. Always check your local voltage requirements.

The electric vacuum is for use on a normal 120 volt circuit. It has a grounded plug that fits the outlet illustrated in Figure A. If a properly grounded outlet is not available, a temporary adapter, such as the adapter illustrated in Figure B and C, may be used to connect the plug into a 2-pole outlet, as shown in Figure C.

The temporary adapter should be used only until a properly grounded outlet, Figure A, can be installed by a qualified electrician. The green color rigid ear lug or grounding means extending from the adapter must be connected to a permanent ground, such as a properly grounded outlet box cover. Whenever the adapter is used, it must be held in place by its grounding means and a metal screw, as shown in Figure C.

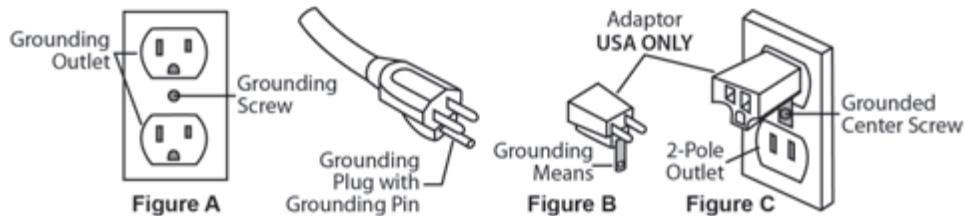

WARNING:

Improper connection of the equipment grounding conductor can result in a risk of electric shock. Check with a qualified electrician or service person if you are in doubt as to whether the outlet is properly grounded. **DO NOT** modify the plug provided with the equipment. If it will not fit into the outlet, have a proper outlet installed by a qualified electrician.

The floor machine is built with a 50 foot (15 M) safety cord which plugs directly into an approved outlet. Use of any extension cords is **NOT RECOMMENDED**.

NOTE: In Canada, the use of a temporary adapter is not permitted by the Canadian Electrical Code.

8.0 Machine Parts List Continued

Item	Description	Part No.	Qty.
59A	Bumper 13" - Yellow	M-232-13/Y	1
59B	Bumper 15" - Yellow	M-232-15/Y	1
59C	Bumper 17" - Yellow	M-232-17/Y	1
59D	Bumper 19" - Yellow	M-232-19/Y	1
59E	Bumper 21" - Yellow	M-232-21/Y	1
60A	Apron 13"	A-163	1
60B	Apron 15"	A-167	1
60C	Apron 17"	A-169	1
60D	Apron 19"	A-171	1
60E	Apron 21"	A-172	1
61	Scrubber Plug	B-50	1
62	Base Casting Screw	B-31	4

8.0 Machine Parts List

Item	Description	Part No.	Qty.
1	Switch Box Back	A-104	1
2	Handle Tube Screw	B-23	2
3	Switch Box Closing Screw	B-21	4
4	Strain Relief Clip	M-213	1
5	Ground Wire Screw	B-68	2
6	Rubber Spacer - Yellow	M-218-Y	2
7	Hand Grip	M-218	2
8	Handle Tube Insert	M-247	1
9	Handle Tube Assembly	M-206	1
10	Cable Hook Screw	B-2	2
11	Cable Hook	A-164	1
12	Sliding Collar	A-111	1
13	Cam Washer	B-37	1
14	Cam Lock Wing Nut	B-25	1
15	Cam Split Washer	B-39	1
16	Bent Brace	M-216	2
17	Yoke Bolt	B-18A	2
18	Yoke Nut	B-19	2
19	Handle Tube Cable	G-16	1
20	Black Rubber Cable Connector	M-249	1
21	Cable Grommet	B-63	1
22	Rectangular Hole Cam Washer	B-67	1
23 A	Cam Assembly	C-100	1
23B	Complete Cam Assembly Kit (Includes 1 each of Drawing Items #13, 14, 15, 22, 23)	CCA	1
24	50-Foot Cable, 14/3-Gauge - Yellow	G-14-15-Y	1
25	Switch Mounting Plate	G-30-B	1
26	Switch Plate Screw	B-1	2
27	Int. Tooth Lock Washer (for Switch)	B-35	1
28	Insulated Flag Wire Connector	G-48	2
29	On-Off Switch and Plate Assembly	G-30-AB	1
30	Lock Washer	B-33	1
31	Trigger Return Spring	G-30-CT057	4
32	Label for Switch Box	Call for #	1
33	Switch Box Front	A-103	1
34	Wire Connector	G-47	1
35	Trigger	A-105	2
36	16" Crossbar	M-211-A	1
37	Safety Interlock Assembly	SIA-1	1
38	Trigger Pin	B-70	2
39	Crossbar Screw	B-22	2
40	Acorn Nut for Yoke Pin	B-8	2
41	Rubber Yoke Spacer	B-5	2
42	Yoke Pin	B-7	1
43	Yoke	A-1001	1
44	Drip Cap Mounting Screw	B-151	3
45	66 Frame Drip Cap Cover	M-242	1
46	66 Frame Drip Cap Cover Bumper	M-239	1
47	Cork Drip Cap Gasket	M-248	1
48	Motor 66 Frame 1.5 HP with Gearbox, 115 V	MOTOR 1.5 HP / GB	1
49	Gear Box, 11:1 Triple Planetary	GB96008,L,H	1
50	Hub Caps	V0038	2
51	Spring Washer	B-51	4
52	6" Wheels	M-245	2
53	1/2" Flat Washer	B-29	2
54	Spring	B-30	2
55	Axel	M-240	1
56	Label for Motor	Call for #	1
57	Main Machine Frame	A-166	1
58	Apron Mounting Thumb Screw	B-96	3

3.0 Assembly Instructions

3.1 Handle Installation

This machine handle (1) has been custom fit to its mounting yoke (2) at the factory and then taken apart for shipping. For easy assembly, make sure that the handle number on the tag (see right) matched the serial number stamped on the chassis.



You will need 7/16" wrenches to complete the assembly:

1. Remove the handle and mounting hardware from the carton. Bolts, nuts, washers and the locking lever assembly are in the plastic bag attached to the handle.

2. Position the handle (1) over the mounting yoke (2) with the power cord (3) facing away from the motor. Push the tube down until the bolt holes are lined up.

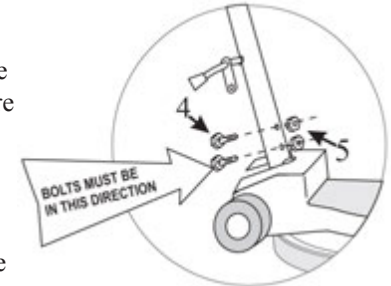

3. Insert the mounting bolts (4) into the bolt holes from the back of the machine. Secure each bolt with a locking nut (5). The locking nuts will face the motor.

4. The handle mounting collar (6) is designed to slide freely up and down the handle tube. This feature allows the handle to be adjusted for the comfortable operation of all users. Align the mounting collar (6) and the two bent handle braces (7).



5. Remove the lever assembly parts from the plastic bag.

- Place the thick spacer with a rectangular hole (9) onto the locking lever shaft (8). The spacer must fit onto the rectangular neck of the lever.

- Insert the shaft through the mounting hole in the right handle brace, the mounting collar and the left handle brace.

- Place the spacer (10) on the shaft.

- Place the split washer (11) on the shaft.

- Adjust the wing nut for tightness. When correctly installed, the collar slides easily when the cam-engineered locking lever is "up," but is firmly fixed when the lever is "down."

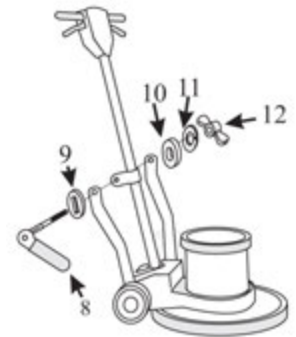

3.2 Install / Change the Apron

If you've purchased more than one apron, you can easily change aprons for different cleaning jobs.

- Lock the handle in the "up" position and tip the floor machine back.
- If you're changing the apron, give the brush a quick flip counterclockwise to unlock and remove the brush.
- Remove the 3 knurled thumb nuts that hold the apron to the machine chassis.
- Remove the existing apron.
- Align the new apron.
- Re-install the three bolts and tighten.
- Install a brush that is 2" smaller than the apron.

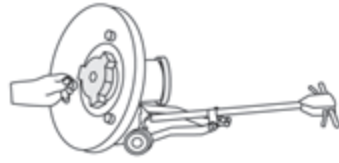

3.3 Attach the Power Cord

The triple-wire grounded power cord has been factory-installed into the handle tube. A flexible rubber cable connector (11) is used to secure the plug-in connections. The floor machine ships with this connector mounted on the cord coming out of the handle (10). Stretch the connector and slip the male connector (9) (coming out of the motor housing) through the connector hole and then into the female connector.

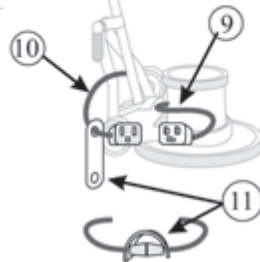

Now, plug the end of the 50 foot cord into a grounded power outlet. Squeeze the triggers on the handle and check for power to the motor.



3.4 Brush or Pad Driver Installation

A brush or pad driver mounts onto your floor machine with a "B" style Universal clutch plate.

Unplug the floor machine. Lock the machine handle in the "up" position and tip the floor machine back onto the handle.

Slide the brush or pad driver clutch plate (11) over the drive plug (12).

Quickly spin the brush counter-clockwise to lock the brush onto the drive plug.

Now, lower the machine back onto the brush. You're ready to go to work.

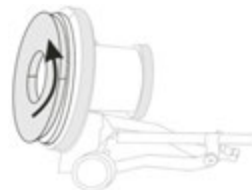
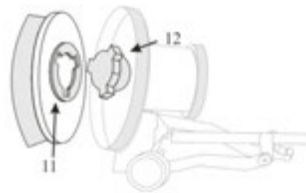

7.0 Machine Schematic Drawing

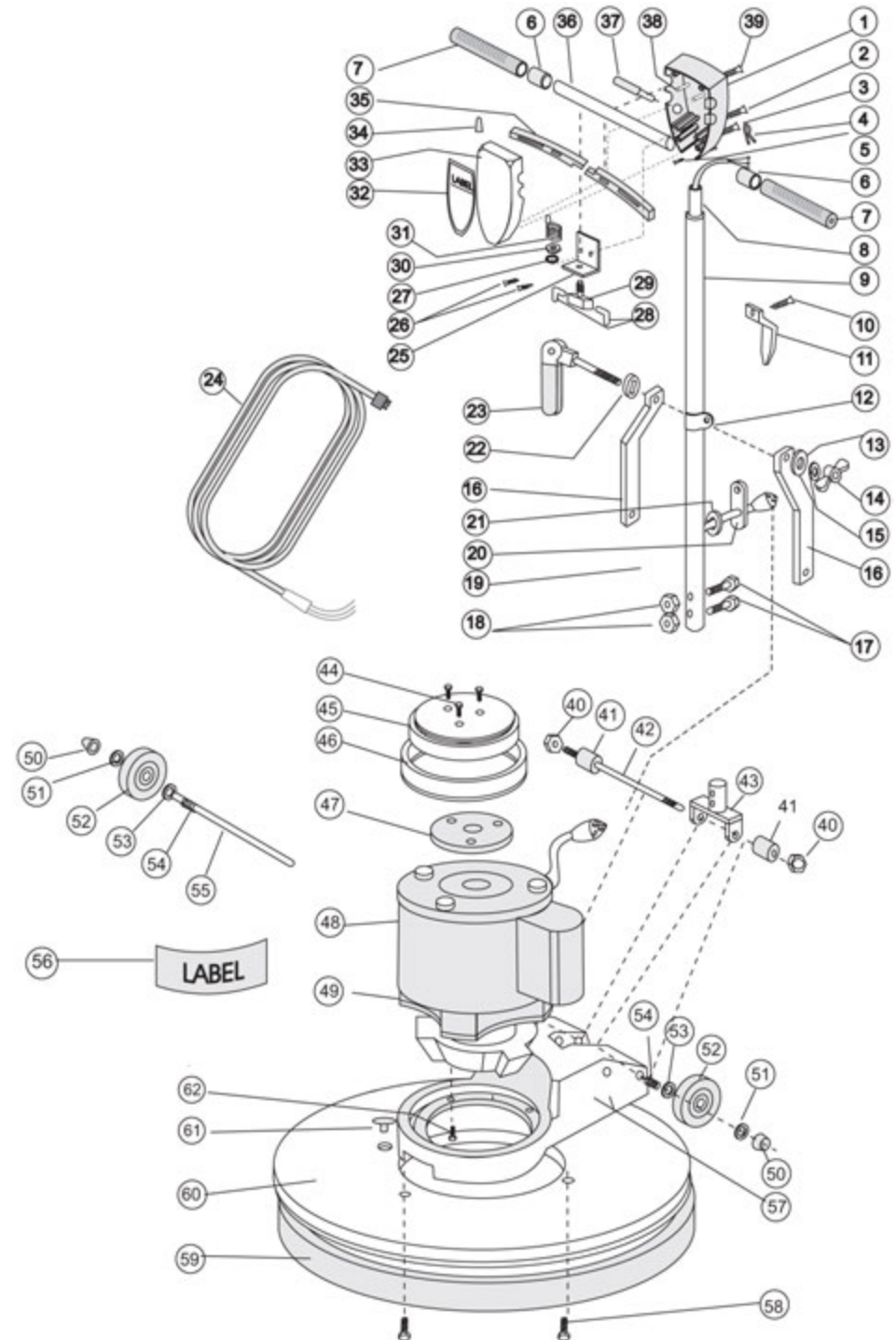

6.2 Scrubbing Brush Filaments

Scrubbing brushes are available with a range of bristle types - from the softest for high-gloss floors, to the most aggressive for heavy soils. Match your brush to the floor as you match a detergent with the soils.



Nylon is used for general scrubbing. Because nylon softens when wet, it is great for gentle scrubbing, mopping and polishing of decorative floors. Nylon will not scratch tile, terrazzo or coated surfaces. Nylon brushes are durable and long lasting.



Polypropylene is a common choice for general purpose scrubbing and works well on both concrete and on coated floors. Polypropylene brushes typically cost less than nylon, but do not last as long.



Non-scuff poly is a finer diameter (0.015-0.018") filament used for lighter duty scrubbing conditions and on waxed or finished floors.



Bassine is a soft, natural fiber. The end of the bristle splits or "flags" to build a polishing surface.



Union mix is a mixture of bassine and tampico (another natural fiber). The mixture is stiffer than bassine alone and is used by more traditional cleaners for scrubbing. It is often replaced by poly.



Soft abrasive bristle is a 0.018" nylon filament extruded with a 500 grade grit. It is used for gentle scrubbing and is as aggressive as a white scrub pad.



Daily abrasive bristle is a 0.035" nylon filament with 180 grade grit. It is used for daily scrubbing of resilient tile and finished floors and is as aggressive as a red scrub pad.



Heavy-duty stripper abrasive bristle is a 0.050" nylon filament with 80 grade grit. It is used for very aggressive scrubbing and stripping of concrete, brick and quarry file. It is as aggressive as a black scrub / strip pad.

4.0 Operating Tips

- For indoor use only. Sweep abrasive soils before scrubbing.
- While the brush or pad driver is spinning, keep the floor machine moving to avoid "donut" burns on the floor.

To Start Operation:

- Unlock the handle by raising the locking lever.
- Lower the handle to a comfortable position, typically waist height.
- Relock the handle by pushing the lever down. **NEVER OPERATE THE MACHINE WITH THE HANDLE UNLOCKED.**
- This floor machine is a high torque motor. Hold the machine firmly with both hands when starting up.
- Push the red safety interlock switch forward to unlock the dual triggers.
- Squeeze the dual triggers to release power to the motor. Once power is on, either trigger will keep power to the motor.
- To stop the floor machine release both triggers.
- The spinning brush helps move the floor machine. (Lift the handle slightly to work to the right. Push the handle down slightly to work to the left.)



SET HANDLE HEIGHT



PUSH LOCK FORWARD

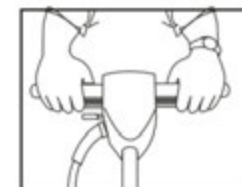

SQUEEZE BOTH TRIGGERS

4.1 To Store your Machine

- Lock the handle in the "up" position. Tilt the machine back and remove the pad driver or brush.
- Wind the cord around the handles and the bottom cord hook.
- Wash brushes or pads and hang to dry. Never store machine standing on the brush.
- Inspect and maintain equipment on a regular schedule for best results.
- Check and clean pads after each operation. Remove soil and chemical buildup. Replace worn or damaged pads.
- Check the triggers and switches for proper operation.
- Repair or replace damaged skirts and dumpers.
- Use air pressure or vacuum to remove dust and debris from the motor vents.
- Report problems and repair promptly.

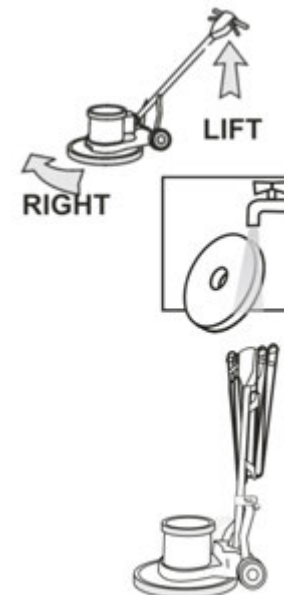

4.2 Transport

To transport this floor machine from the janitor's closet to the work area:

- Lock the handle in the “up” position. Wind the cord around the handles and the bottom cord hook.
- Tip the machine back onto the transport wheels. Push or pull the machine by the handle, not by the cord or any other part of the machine. Travel carefully.



5.0 Troubleshooting Guide

Never operate this floor machine when the equipment is not performing as expected or when any part is visibly damaged. The cause and solution for some basic problems are described below. When repair is needed, take the equipment to an authorized repair service center.

5.1 The Floor Machine will not Run

- Circuit breakers are tripped in the building. **Check and reset.**
- Equipment is unplugged. **Check plug, wall and at machine base. Plug in.**
- Power cord failure. **Test with a working power cord. Lock the handle up and tip the motor back. Unplug the cord at the motor and plug the motor into your working power cord.**
- **IMPORTANT! THIS IS JUST FOR TESTING. When you do this, you have removed the safety handle controls from the circuit and you are sending power directly to the motor. If the motor now spins, the problem is in the cord of the handle assembly. Seek authorized repair services.**
- **If the motor still does not spin, the problem is either in the male connection at the motor base or in the motor. Seek authorized repair service.**
- Motor sparks or smokes. **Seek authorized repair service.**

5.2 Electrical Shock to Operator

- Equipment wiring failure or electrical short in the machine. **Seek authorized service.**
- Poor grounding or no grounding. **Test the outlet with a ground fault interrupter. Retain certified electrician to inspect and repair grounding. NEVER clip off the ground plug on your cord.**
- Repeated circuit breaking. **High amp draw and circuit breaking can be an electrical or mechanical problem. Seek authorized repair service.**

5.3 High Vibration

- Pads are not centered on the pad driver. **Tip machine back and re-center the pad.**
- Uneven wear or warp of pads, pad drivers or brushes. **Replace.**
- Machine chassis is damaged by dropping. **Replace.**

6.0 Brush Construction

Your new floor machine provides reliable, efficient, safe power to your scrubbing brush. To get the best results, you need to use a brush of the best design and construction.

Your floor machine is built with a “B” style drive plug (1). The height and width of the ears on the plug will match a “B” style or “Universal” clutch plate (2) mounted on the brush block.

The brush block (3) is constructed of molded plastic or this plywood. Use a brush with a block diameter 2” less than your machine apron size.

The bristle material (4) that actually does the scrubbing is typically 1-1/2” to 2” long. Holes are drilled in the block and bundles of bristles are folded in half, forced into the hole and stapled in place (staple-set).

When the bristles wear down to less than 1/2” long, they have little flexibility and it's time to replace. Bristle materials are described on page 11.

6.1 Pad Driver Construction

If you scrub or polish with a non-woven pad, use a pad driver to connect the pad to the machine.

The brush block (3) is constructed of molded plastic, fit with shorter, stiffer, pad-holding bristles (5) or “velcro-like” pad-holding hooks (6) and use a riser (7) to create extra clearance between the block and the machine apron. With this construction, use a pad driver with block diameter 1” less than your machine apron size.

A complete machine includes (1) base unit with (1) or more aprons.

Machine Apron Size	13”	15”	17”	19”	21”
Pad Driver - with 3/4” Riser	12”	14”	16”	18”	19”
Brush - with NO RISER	11”	12”	15”	17”	18”

