



GENERAL CATALOGUE 2 0 2 1





GENERAL CATALOGUE 2 0 2 1



We are designing the future. **Right now.**

Thanks to the experience acquired in over thirty years of presence on the market, HT has established in Italy as a leading company in the field of electric devices. HT designs and develops a wide and reliable range of devices for checking electric safety, for power quality and energy consumption analysis and for checking, testing and maintaining photovoltaic systems.

Continuously staying up to date and keeping up with the latest developing technology, the Company has always offered to the Customers cutting-edge products, carefully studied under every aspect as regards safety, quality of the materials, modern design and ease of use.

From the sector of electric safety checking, HT has extended its expertise to the photovoltaic field as well, following a path of continuous evolution which combines a proven technology with innovation and care for every detail. Its wide range of products makes up a comprehensive offer for those who want to be sure they work in full compliance with the laws, in total safety and with cutting-edge technology.

The culture of research and innovation, together with the utmost attention to safety and the products' reliability are the pillars of the corporate philosophy of HT.

The primary target is the attention to the Customer: that's the main reason why the Company decided, in 1998, to achieve quality certification according to UNI EN ISO 9001.

This certification has further enhanced the quality of the production processes of products and services: as required by the laws in force, all HT products are provided with the CE mark. Anyway, for a better protection of Customers, certification is only granted after tests are carried out by prominent and specific inspection authorities, which are totally independent from the company to be evaluated.

Electric safety as a basic requirement of high-quality devices

Further to carrying out their function, devices for electric measurement must focus on the **operator's safety** as a basic requirement as regards **protection from instant overvoltage** which may generate because of the presence of **complex charging networks, short circuits, atmospheric charges, etc...**

In this respect, international standard **IEC 61010-1** harmonized in Europe with **EN 61010-1** has devised precise rules which electric devices used for measurements in LV (<1000VAC) must comply with. Four **"Overvoltage Categories"** were created, which define the protection level against voltage spikes of each device according to the distance from the power supply source. Devices in the highest category need a higher internal protection as they can operate near the power supply source. A short description is outlined below:

OVERVOLTAGE CATEGORY:



TYPE OF MEASUREMENT
Measurements carried out on circuits not directly connected to the distribution power

APPLICATION
Protected electronic devices, measurements on circuits not derived from power



TYPE OF MEASUREMENT
Measurements carried out on circuits directly connected to the low-voltage installation

APPLICATION
Household devices, mobile devices and similar



TYPE OF MEASUREMENT
Measurements carried out in the building installation

APPLICATION
Distribution boards, wirings, switches, sockets in fixed installations, electric motors, industrial devices



TYPE OF MEASUREMENT
Measurements carried out at the source of the low-voltage installation

APPLICATION
Electricity meters, measurements on primary overcurrent protection devices, ripple control units

Why using TRMS devices

In modern domestic and industrial installations, the use of so-called **"non-linear loads"** (e.g. computer networks, variable speed devices, switching suppliers, etc...) is increasing. These loads contribute to the **sometimes remarkable deformation of the waveform of the signals applied to it**, taking it further and further from the traditional sinusoidal waveform typical of "linear" loads (consisting in resistors, inductance or capacitance). Normal measuring devices (multimeters and clamp meters) for measuring alternating voltage and current of **"average-value"** type allow precise measurements **only on sinusoidal waveforms of signals, hence on linear loads.**

To measure non-linear loads, the generation of **harmonic components** which cause the **distortion of the waveform** of the signal, makes the use of **TRMS (True Root Mean Square) devices** necessary, since the average-value devices, taking only the value of fundamental frequency of 50Hz into consideration, may bring to **even remarkable mistakes** of the value reading.

Further to the TRMS value of the fundamental frequency, **TRMS** devices also provide the **TRMS value of the whole waveform, including harmonic components**, within the bandwidth they are designed for. Therefore, when measuring the same quantity with devices of both types, the obtained values will be identical only if the waveform of the signal is purely sinusoidal. In case of distorted waveforms, instead, **TRMS devices** always provide higher values than those measured by corresponding average-value devices. Therefore, the use of **TRMS** measuring device is essential when carrying out measuring and maintenance operations on industrial electric systems in order to obtain **reliable reading values** of the measured quantities.

ALPHABETICAL INDEX



COMBI419	51	HT4010	123	IRONMETER	94
COMBI421 • COMBI420	50	HT4011	122	ISO410	71
COMBIG2	48	HT4013	119	JUPITER	76
DM40	185	HT4020 • HT4022	120	LINESPLITTER	134
DT103S	172	HT5	139	M70	72
DT8806H	170	HT-5000	130	M71	61
ECLIPSE	110	HT6	104	M72	72
EV-TEST100	62	HT61 • HT62 • HT63 • HT64 • HT65	90	M73	79
F3000	124	HT7	104	M75 • M74	53
F30 • F40 • F50	173	HT70	137	MACROEVTEST	60
FLASHMETER	94	HT7004 • HT7005	126	MACROTESTG1	46
FULLTEST3	54	HT701	96	MACROTESTG2	46
GEO416	60	HT7051	69	MACROTESTG3	44
GSC60	42	HT7052	68	MERCURY	93
HT10	104	HT712	98	MPP300	24
HT100	125	HT77C • HT79	127	NEPTUNE	70
HT12	102	HT8	104	PQA819 • PQA820	30
HT14D	103	HT8051	82	PQA823 • PQA824	28
HT155 • HT157	166	HT8100	83	PV-ISOTEST	20
HT204	163	HT82	136	PVCHECKS	22
HT2055	64	HT9012	118	QUICKLAN6050N	143
HT20s	137	HT9014	117	QUICKLAN6055	142
HT21 • HT211	100	HT9015	116	SOLAR I-Ve	18
HT2234N	131	HT9019	112	SOLAR300N	20
HT25N	100	HT9020	114	SPEED418	78
HT309	162	HT9021	113	T2000 • T2100	62
HT3010 • HT3013	118	HT9023	33	THT33	150
HT3300	159	HT9025	111	THT45W • THT46	149
HT3302	158	HTA102	167	THT60	148
HT3305	159	HTA103 • 105 • 106 • 107	157	THT70	148
HT36	129	HTANALYSIS™ • HTCLOUD™	38	VEGA78	28
HT38	138	HTB500	153	XL421 • XL422	36
HT39	95	I-V400w • I-V500w	18	XL423 • XL424	37
HT401	97	iDM70	170		

GENERAL INDEX OF THE DEVICES

DEVICES FOR PHOTOVOLTAIC FIELDS	
I-V500w • I-V400w • SOLAR I-Ve	P. 18
PV-ISOTEST	P. 20
SOLAR300N	P. 22
PVCHECKs	P. 24
MPP300	P. 26
POWER QUALITY ANALYZERS	
PQA824 • PQA823 • VEGA78	P. 30
PQA820 • PQA819	P. 32
HT9023	P. 35
DATA LOGGERS	
XL421 • XL422	P. 38
XL423 • XL424	P. 39
HTANALYSIS™ & HTCLOUD™	P. 40
ELECTRICAL INSTALLATION SAFETY TESTERS	
GSC60	P. 44
MACROTESTG3	P. 46
MACROTESTG2 • MACROTESTG1	P. 48
COMBIG2	P. 50
COMBI421 • COMBI420	P. 52
COMBI419	P. 53
M75 • M74	P. 55
FULLTEST3	P. 56
ELECTRIC VEHICLE SUPPLY EQUIPMENT CHECK	
MACROEVTEST	P. 60
EV-TEST100	P. 62
EARTH RESISTANCE AND STEP/CONTACT VOLTAGE MEASURING DEVICES	
GEO416	P. 66
M71	P. 67
T2000 • T2100	P. 69
HT2055	P. 70
INSULATION AND CONTINUITY MEASURING DEVICES	
HT7052	P. 74
HT7051	P. 75
NEPTUNE	P. 76
ISO410	P. 77
M72	P. 78
M70	P. 79
RCD AND LOOP VERIFICATION DEVICES	
JUPITER	P. 82
SPEED418	P. 84
M73	P. 85
PROCESS CALIBRATORS	
HT8051	P. 90
HT8100	P. 91
PROFESSIONAL TRMS MULTIMETERS	
HT65 • HT64 • HT63 • HT62 • HT61	P. 98
JUPITER • NEPTUNE	P. 100
MERCURY	P. 101
IRONMETER • FLASHMETER	P. 102
HT39	P. 103
HT701	P. 104
HT401	P. 105
HT712	P. 106

DIGITAL MULTIMETERS	
HT211 • HT21 • HT25N	P. 108
HT12	P. 110
HT14D	P. 111
HT10 • HT8 • HT7 • HT6	P. 112
CLAMP METERS	
HT3013 • HT3010	P. 118
ECLIPSE	P. 120
HT9025	P. 121
HT9023	P. 122
HT9021	P. 123
HT9020	P. 124
HT9019	P. 125
HT9015	P. 126
HT9014	P. 127
HT9012	P. 128
HT4013	P. 129
HT4022 • HT4020	P. 130
HT4011	P. 132
HT4010	P. 133
F3000	P. 134
HT100	P. 135
HT7004 • HT7005	P. 136
HT79 • HT77C	P. 137
BURIED CABLE LOCALIZER AND REVOLUTION COUNTER	
HT36	P. 139
HT-5000	P. 140
HT2234N	P. 142
PHASE DETECTORS, SWITCH DETECTORS AND PHASE SEQUENCE INDICATORS	
LINESPLITTER	P. 144
HT82	P. 146
HT70 • HT20s	P. 147
HT38	P. 148
HT5	P. 149
DEVICES FOR LAN NETWORK VERIFICATION	
QUICKLAN6055	P. 152
QUICKLAN6050N	P. 153
INFRARED THERMAL CAMERAS	
THT70	P. 158
THT60	P. 160
THT46 • THT45W	P. 161
THT33	P. 162
BORESCOPIES	
HTB500	P. 165
THERMOMETERS AND THERMO-ANEMOMETERS	
HTA107 • HTA106 • HTA105 • HTA103	P. 169
DT103S	P. 170
DT8806H	P. 172
HT3305 • HT3300	P. 173
LIGHT METERS AND SOLAR METERS	
HT309	P. 176
HT204	P. 177
SOUND LEVEL METERS	
HT155 • HT157	P. 180
HTA102	P. 181
LASER METERS	
IDM70	P. 184
DM40	P. 185
PROFESSIONAL SCISSORS	
F30P • F40 • F50	P. 187

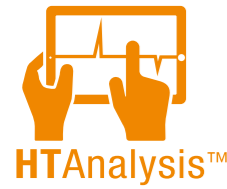

HTANALYSIS. I-V curve and much more.



Download free
App HTANALYSIS™
for iOS and Android devices

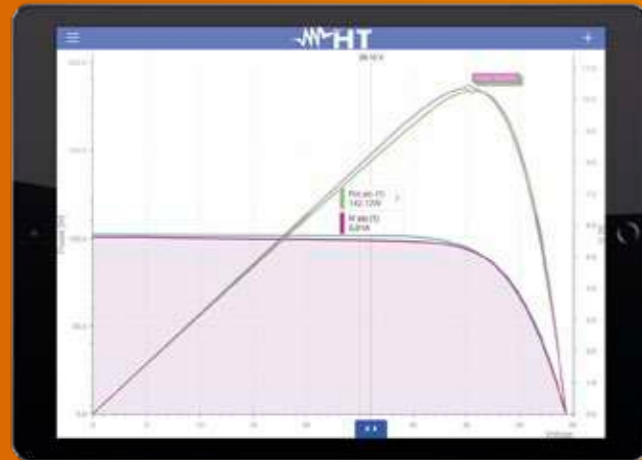

The I-V curve is just the beginning.

With your mobile device HTANALYSIS™ it will help you understand the nature of the problems occurring in photovoltaic installations.



Modules' database, you'll have more than 30.000.

Organize the modules in the your device's memory. You can add new ones, delete old ones or simply see the saved ones in your device.

Data analysis. OK or NOT OK?

Start the analysis by selecting the I-V curve just downloaded. Once you have finished the analysis, please remember to complete measurement by attaching a **picture**, a **voice note**, a **text note** and a **video**.
Ah, yes. IT takes just a minute and you've already finished.



Your personal assistant.

HTANALYSIS™ is the only app with **Interactive Solution Center**. According to the nature of the I-V curve measured in the **Interactive Solution Center**, once you have selected the I-V curve most similar to the one obtained through your measurement, you'll have a series of indications on the possible problems and possible solutions.

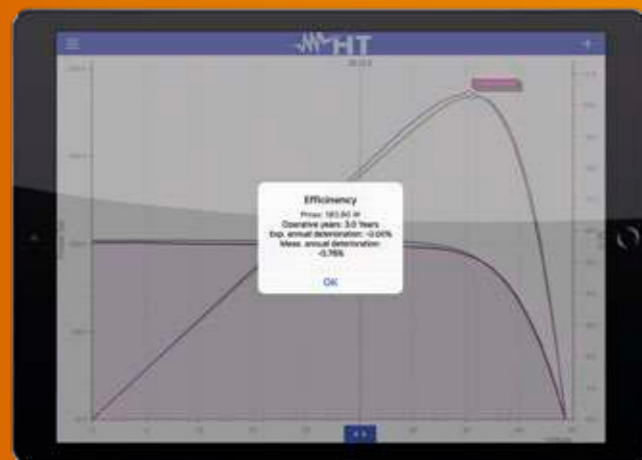
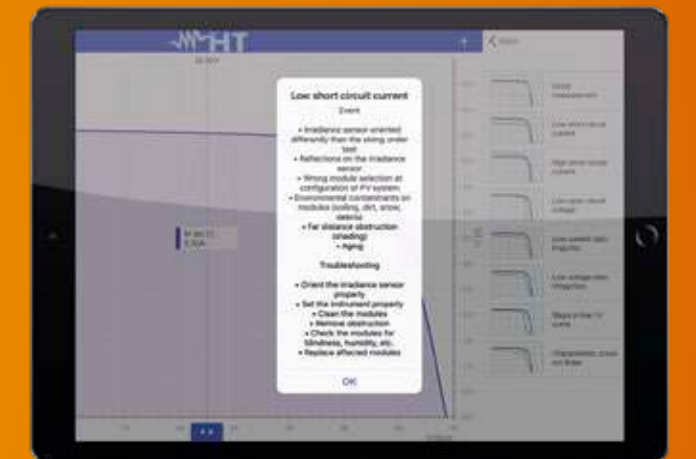

Cell deterioration. What's the truth? Function Jump™

Insert the production date of the photovoltaic modules to be tested and the app will indicate the real deterioration compared to the one declared by the manufacturer.



HT Cloud™ Share. When, How and Where you want.

Download HTANALYSIS™ and use HTCloud™ as a personal database and **share your measurements** with your colleagues at any time and in **any place in the world**. Ah, yes: if you upload your measurements onto HTCLOUD™, you'll find them immediately in the TOPVIEW software on your PC.

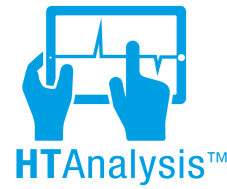

HTANALYSIS. Mains analysis.



Download free
App HTANALYSIS™
for iOS and Android devices



In real time #1

ALL values you need to know, immediately.

- > Voltage and current
- > Power (kW - kVA - kVAR)
- > THD% on voltage and current
- > Power Factor and dPF (Cosphi)

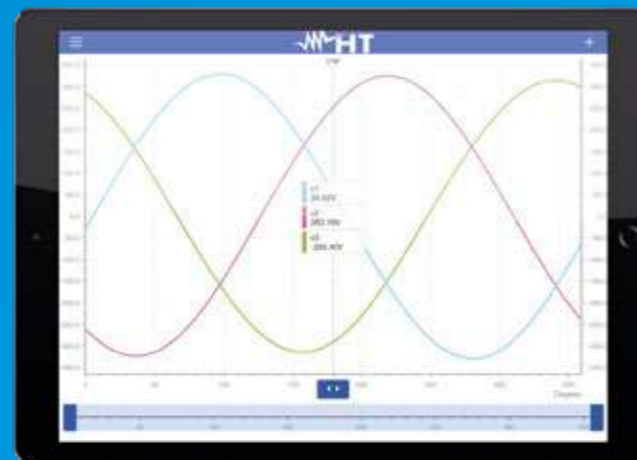

In real time #2

Waveforms

- > Voltage waveform
- > Current waveform
- > Indication of the phase angle

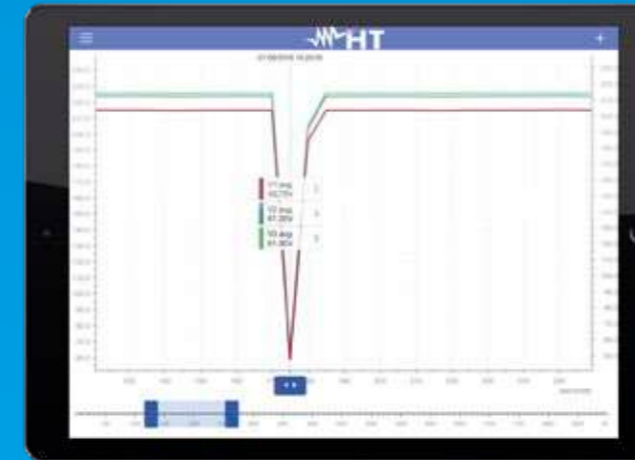

Mains analysis #1

Enough with reading numbers. Now you can also see them. Download your recordings and analyze them directly on site. HTANALYSIS™ makes it possible to immediately analyze all recorded quantities in a few steps.



Mains analysis #2

Voltage anomalies, Dips, Peaks and Interruptions. Immediately discover the nature of voltage anomalies with their relevant value and its duration.

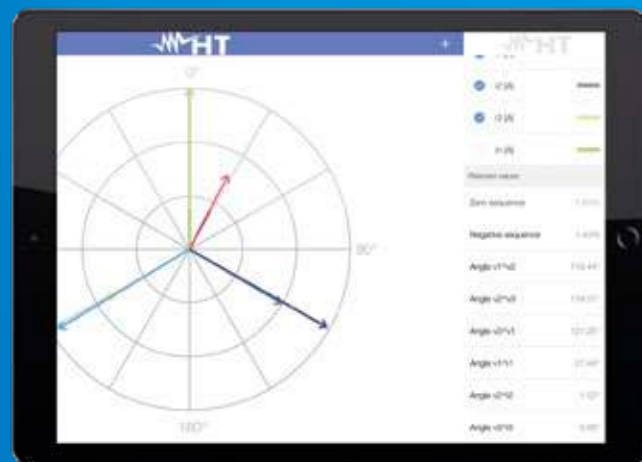

In real time #3

Vector diagram

- > Voltage and current diagram
- > Negative and zero sequence
- > Graphic and table indications



In real time #4

Harmonics.

- > Voltage and current harmonics
- > Immediate display of values through cursor

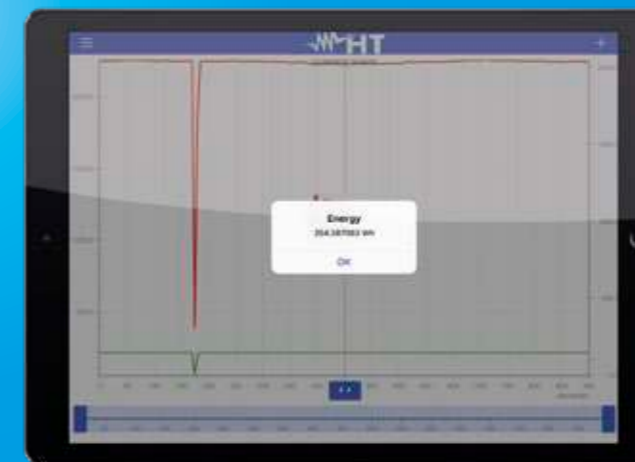

Mains analysis #3

Power and Energy combined with time. Select "Power" from the interactive menu on the right and move the cursor onto the date and time you are interested in. Now touch the arrow in the middle of the cursor and you'll immediately display the energetic consumption according to time. All in less than 10 seconds.



HT Cloud™

Share. When, how and where you like.

Download HTANALYSIS™ and use HTCloud™ as a personal database and share your measurements with your colleagues at any time and in any place in the world. Ah yes, if you upload the measurements onto HTCLOUD™, you'll find them immediately in the TOPVIEW software on your PC.



HTANALYSIS. Electric safety.



Download free
App HTANALYSIS™
for iOS and Android devices



Everything always well organized.

Waste no more time writing down information and values of your measurements on paper. Thanks to HTANALYSIS™, the structure of saved measurements shall be similar to this one:

- › First level folder (Home, Industry)
- › Second level folder (Switchboard, Bedroom)
- › Third level folder (Socket, Switch, RCD, MCB)



Multimedia contents on every measurement. Always.

Each measurement can be completed with an attachment, such as pictures, videos, voice notes or text notes. Please remember that all of these attachments will be automatically available on TOPVIEW (PC software) through HT Cloud.

List of measurements with their result.

Every time you download a measuring campaign onto your tablet, you will get:

- › Result of measurement OK or NOT OK
 - › Type of measurement carried out
 - › Date and time of measurement



No more need for paper notepads.

Adding a text note to every measurement means that it is not necessary to use paper notepads any more, which would force you to copy again in the PC software all notes made while preparing the report.



Function Smart Check™

Without downloading all measurements, it is possible to attach to the last measurement carried out a picture, a video, a voice note or a text note.



HT Cloud™ Share. When, How and Where you want.

Download HTANALYSIS™ and use HTCloud™ as a personal database and share your measurements with your colleagues at any time and in any place in the world. Ah, yes: if you upload your measurements onto HTCLOUD™, you'll find them immediately in the software TOPVIEW on your PC.



PHOTOVOLTAIC TESTERS

VERIFICATION PHOTOVOLTAIC FIELD

PERFECTION FOR THE SUN

New HT solutions for performance optimization and troubleshooting.

Thanks to the decrease in the cost of components and the remarkable increase of performance, installing photovoltaic systems on the roof or on the ground has become increasingly common. In a photovoltaic system, problems connected to safety and to the system's performance must be checked, and maintenance of strings and single panels must be carried out.



Troubleshooting

- It may happen that, during the operation of a system, **some modules may jeopardize the performance** of the whole system. When system efficiency is lower than expected, it is necessary **to detect the defective modules** so that they can be replaced. This is obtained by measuring the I-V curve with devices **I-V400w** (for DC voltage up to 1000V) **SOLAR I-Ve** and **I-V500w** (for DC voltage up to 1500V).

Commissioning Tests

- When **operating** a photovoltaic system, it is necessary to **certify its safety according to IEC62446**. The suitable device to carry out these verifications is **PVCHECKs**.

Performance

- Performance **Recording** is one of the **necessary requirements** to make **maintenance programs efficient**. By monitoring system performance it is possible to **certify a production loss** quickly and efficiently. **SOLAR300N**, **SOLAR I-Ve** and **MPP300** are the **ideal solution for recording over time the production of a system** and the **performance check of an inverter**.

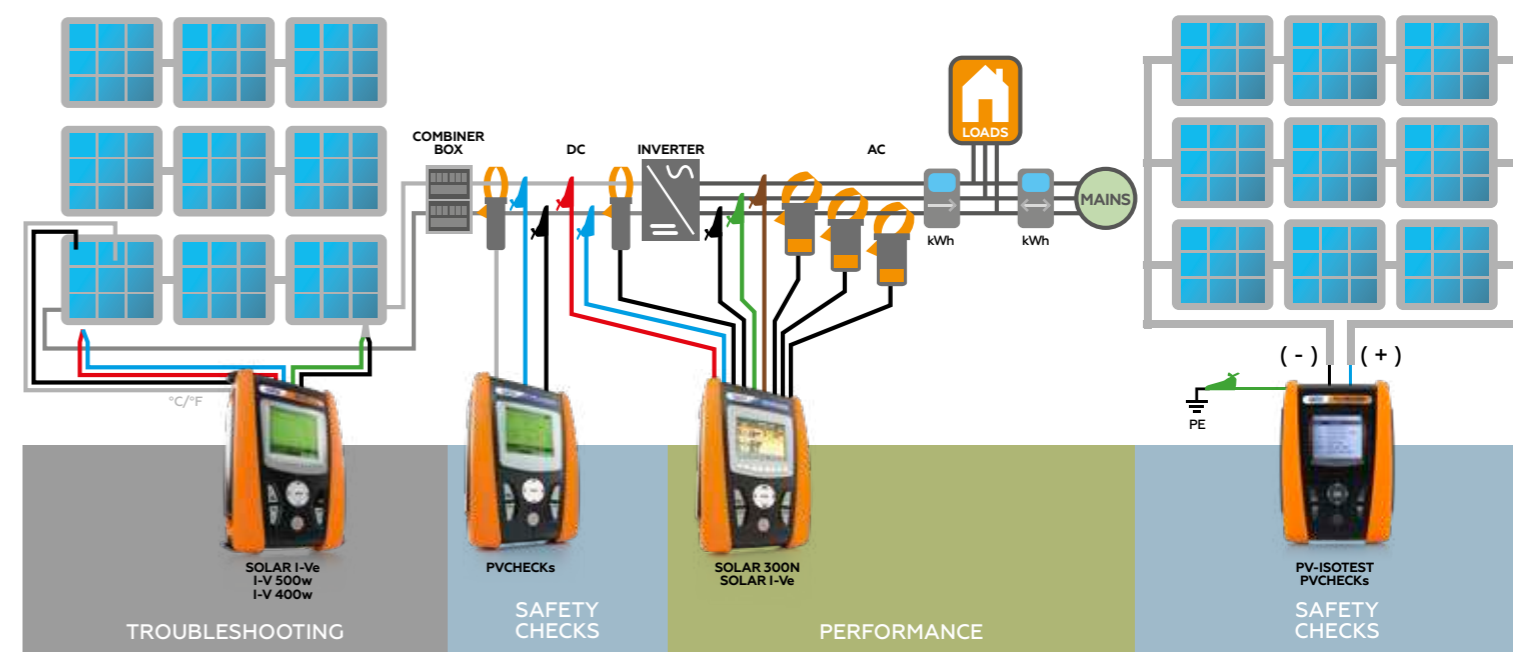

PHOTOVOLTAIC TESTERS



I-V500w I-V400w SOLAR I-Ve SOLAR300N PVCHECKs PV-ISOTEST MPP300

MAINTENANCE AND EFFICIENCY OF THE PHOTOVOLTAIC SYSTEM

	MAINTENANCE		MAINTENANCE AND EFFICIENCY				
Measurement of I-V curve on PV modules and strings	•	•	•	-	-	-	-
Automatic measurement with AutoSequence™ mode	•	•	•	-	-	-	-
Quick IVCK test for measuring Voc and Isc on PV modules and strings	•	•	•	-	•	-	-
Single-phase/three-phase photovoltaic systems' testing	-	-	• 1MPPT (3MPPT with MPP300)	• 1MPPT (3MPPT with MPP300)	-	-	•
Continuity of protective conductors with 200mA	-	-	-	-	•	•	-
PV strings/field insulation with no service interruption with test voltage 250, 500, 1000V DC	-	-	-	-	•	• (1500VDC)	-
DC side efficiency of the photovoltaic field	-	-	-	•	•	-	-
	-	-	-	-	-	•	-
Use of remote unit SOLAR-02 with USB \ RF connection	• RF	• RF	• RF	• USB	• RF	-	• RF • USB
Measurement of irradiation with reference cell	•	•	•	•	•	-	-
Temperature measurement of cell and environment	•	•	•	•	•	-	-

MAINS ANALYSIS

AC/DC voltage in single-phase/three-phase systems	-	-	-	•	-	-	•
AC/DC current in single-phase/three-phase systems	-	-	-	•	-	-	•
Cosphi, Power Factor	-	-	-	•	-	-	-
Voltage unbalance (NEG%, ZERO%)	-	-	-	•	-	-	-
Active P, Reactive Q, Apparent S Power/Energy	-	-	• Only active P	•	-	-	-
Voltage and current harmonics up to the 49 th with calculation of THD%	-	-	-	•	-	-	-
Voltage anomalies (dips, peaks) with a resolution of 10ms (@ 50Hz)	-	-	-	•	-	-	-
Voltage spikes with a resolution of 5µs (200kHz)	-	-	-	•	-	-	-
Electric motor starting current (INRUSH)	-	-	-	•	-	-	-
Voltage flickers (Pst, Pit)	-	-	-	•	-	-	-
Full analysis EN50160	-	-	-	•	-	-	-
Phase sequence	-	-	-	•	-	-	-
Neutral-Ground Voltage	-	-	-	•	-	-	-
Neutral current	-	-	-	•	-	-	-

MEMORY AND RECORDING

Max number of simultaneously selectable parameters	-	-	9	251	-	-	-
Recording with selectable integration period	-	-	5s-60m	1s-60m	-	-	1s-60m
Indicative memory duration (in days @ IP=10min @ max number of parameters)	-	-	8	90	-	-	8



I-V500w I-V400w SOLAR I-Ve SOLAR300N PVCHECKs PV-ISOTEST MPP300

»» FOLLOWS

	MAINTENANCE		MAINTENANCE AND EFFICIENCY				
Internal memory extension with Compact Flash card	-	-	-	•	-	-	-
Default and custom recordings	-	-	-	•	-	-	-

REAL-TIME DISPLAY

Summary table of main electric parameters	•	•	•	•	•	-	-
Voltage/current waveforms	-	-	-	•	-	-	-
Tables or histograms of Harmonics and THD%	-	-	-	•	-	-	-
Voltage/current vector diagram	-	-	-	•	-	-	-

ADDITIONAL CHARACTERISTICS

Measuring range of curve I-V / Isc-Voc	1500V / 15A**	1000V / 15A	1500V / 15A**	-	1000V / 15A Isc-Voc only	-	-
Measuring range for photovoltaic testing	-	-	1000VDC / 265VAC	1000VAC-DC 3000A	-	-	1000VDC / 600VAC 3000AC / 1000ADC
Measurement category	CAT III 300V	CAT III 300V	CAT III 300V	CAT IV 600V	CAT III 300V	CAT III 1500V DC CAT III 1000V AC	CAT IV 300V
Touchscreen colour display	-	-	-	•	-	-	-
Backlit LCD display	•	•	•	-	•	•	-
Internal memory capacity	200 curves I-V	200 curves I-V	200 curves I-V 8 days@ IP=10 min	15MB 90 days@ IP= 10min	999 Locations	999 Locations	2MB 8 days@ IP=10 min
USB port for data download onto Pen Drive	-	-	-	•	-	-	-
Provided PC interface with software for Windows	•	•	•	•	•	•	-
Built-in WiFi communication interface	•	•	•	-	-	-	-
Custom management of internal PV module database	•	•	•	-	•	-	-
Power supply with rechargeable battery and battery charger	-	-	-	-	-	-	•
Auto power off	•	•	•	•	•	•	•
Indication of recording duration for photovoltaic testing	-	-	•	•	-	-	-
Reference standard for mains quality	-	-	-	EN50160	-	-	-
Help on line on the display	•	•	•	•	•	•	-
Size (LxWxH) (mm)	235x165x75	235x165x75	235x165x75	235x165x75	235x165x75	235x165x75	300x265x214
Weight in kg (batteries included)	1,2	1,2	1,2	1	1,2	1,2	2,3
Reference standard for safety	IEC/EN61010-1	IEC/EN61010-1	IEC/EN61010-1	IEC/EN61010-1	IEC/EN61010-1	IEC/EN61010-1	IEC/EN61010-1
Order code	HV00500W	HV00400W	HV000IVE	HV00300N	HV00PVCS	HV00VISO	HVMPP300

* Optional set of leads KIT KELVIN necessary.

** Only I-V500w and SOLAR I-Ve (max current @1500V=10A, max current @1000V=15A).

ORDER CODE HV00500W | HV00400W | HV0001VE

I-V500w | I-V400w | SOLAR I-Ve

MULTIFUNCTION DEVICES FOR MAINTENANCE AND TROUBLESHOOTING ON PHOTOVOLTAIC INSTALLATIONS



- Measurement of the I-V curve of one or more modules or of one whole string up to 1500V/15A**
- Measurement of open-circuit voltage and short-circuit voltage Voc/Isc up to 1500V/15A**
- Database of 30.000 selectable photovoltaic modules
- Automatic measurement of more strings in AutoSequence™ mode*
- Compatible with the App HTAnalysis™ via WiFi

I-V400w allows the on-site detection of the I-V curve and of the main characteristic parameters both of a single module and of strings of modules for PV installations up to a maximum of 1000V and 15A. For measuring the I-V curve, V400w manages an internal database of the modules, which can be updated at any time by the user, and comparison between the measured data with the rated values allows immediately evaluating whether the string or the module fulfills the efficiency parameters declared by the manufacturer.

The I-V curve can be measured also by decentralizing measurements of irradiation and temperature by using the optional remote unit SOLAR02, using the radio frequency connection (RF) to the master unit. Also for V400w, the display at the end of the test of the I-V curve is a clear indication about the compliance with the specifications declared by the panel manufacturer.

* Optional set of leads KIT KELVIN necessary.
** Only I-V500w and SOLAR I-Ve (max current @1500V=10A, max current @1000V=15A).

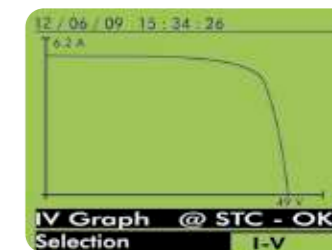

Result of I-V Curve: OK

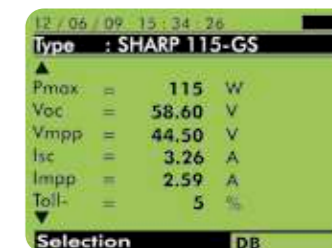

Manual insertion of a module

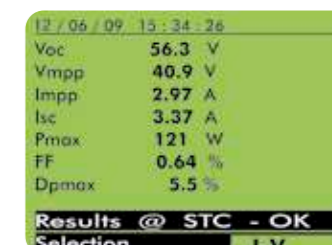

Detail of the single results of I-V Curve: OK

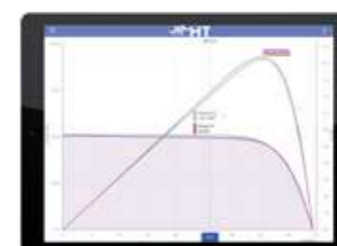

I-V curve and power curve.



List with measured results.



Comparison between foreseen cell deterioration and measured value.



General Menu

Functions

	I-V400w	I-V500w	SOLAR I-Ve		I-V400w	I-V500w	SOLAR I-Ve
Maintenance of photovoltaic system				Internal memory for data saving	•	•	•
Measurement of PV module/string output voltage	1000V	1500V**	1500V**	Recalling measured data on the display	•	•	•
Measurement of PV module/string output current	15A	15A	15A	Optical/USB interface for data transfer onto the PC	•	•	•
Resolution (spots) of I-V curve in Standard or Capacitive mode	128	128	128	Built-in WiFi communication interface	•	•	•
Measurement of Voc-Isc-Pmax-Vmpp-Imp-Fill Factor	•	•	•	Help on line on the display	•	•	•
Measurement of cell temperature through external feeler	•	•	•	Efficiency measurements of the photovoltaic system			
Measurement of irradiation [W/m²] through reference cell	•	•	•	DC/AC TRMS single-phase voltage	-	-	•
Measurement of DC and rated power at module/string output	•	•	•	DC/AC TRMS single-phase current	-	-	•
Detection of I-V curve through remote unit SOLAR-02	•	•	•	Single-phase DC power / AC active power	-	-	•
Measurement of resistance of series Rs of panels	• Max/Min	• Max/Min	• Max/Min	Solar irradiation [W/m²] with reference cell HT304N	-	-	•
Direct comparison with reference conditions (STC - 1000W/m², 25°C)	•	•	•	Panel and environmental temperature through probes	-	-	•
Test result OK / NO	•	•	•	Remote unit SOLAR02 with RF connection	-	-	•
Internal database for managing up to 30 PV modules (30.000 modules by software)	•	•	•	Display of environmental data in real time	-	-	•
				Use of compensation relationships Cells/Environment on Pdc	-	-	•
				Parameter recording of a PV system with 5s to 60min programmable IP	-	-	•

Included accessories

SOLAR02	Remote unit for Irradiation and Temperature (SOLAR I-Ve)
KITGSC4	Set of 4 cables + 4 alligator clips
KITPVMC3	Set of 2 adapters with connectors MC3
KITPVMC4	Set of 2 adapters with connectors MC4
HT4005K	Standard 200A AC clamp, diameter 40mm (3pcs) (SOLAR I-Ve)
HT4004	Standard 10-100A DC clamp, diameter 32mm (SOLAR I-Ve)
HT304N	Sensor for irradiation measurement
PT300N	PT1000 probe for PV modules temperature (SOLAR I-Ve)
M304	Mechanical inclinometer
TOPVIEW2006	Windows software + optical/USB C2006 cable
SP-5100	Sheaths to use the device with free hands (SOLAR I-Ve and I-V500w)
VA500	Rigid carrying case
	User manual on CD-ROM
	ISO9000 calibration certificate
	Quick guide

Optional accessories

MPP300	Accessory for (AC) three-phase efficiency verification up to (3MPPT) (SOLAR I-Ve)
HT4005N	Standard AC 0÷5A, 0÷100A clamp, diameter 20mm (SOLAR I-Ve)
HT96U	Standard 1-100-1000A AC clamp, diameter 54mm (SOLAR I-Ve)
HT97U	Standard 10-100-1000A AC clamp, diameter 54mm (SOLAR I-Ve)
HT98U	Standard 1000A DC clamp, diameter 50mm (SOLAR I-Ve)
HP30C2	Standard 200-2000A AC clamp, diameter 70mm (SOLAR I-Ve)
HP30C3	Standard 3000A AC clamp, diameter 70mm (SOLAR I-Ve)
HP30D1	Standard clamp, diameter 83mm 1000A DC (SOLAR I-Ve)
SP-0400	Shoulder strap to use the device with free hands (I-V400w)
SP-0500	Sheaths to use the device with free hands (I-V400w)
KITPVEXT25M	Set of 2 banana cables 4mm, Green/Black, 25m
606-IECN	Connectors with magnetic terminal
KITKELVIN	Test leads for measurements in automatic sequence



ORDER CODE **HV00PVCS**

PV-ISOTEST

MULTIFUNCTION INSTRUMENT FOR VERIFICATION OF ELECTRIC SAFETY AND SEARCHING FOR FAULT CONDITIONS IN A PHOTOVOLTAIC SYSTEM

PV-ISOTEST is a true innovation, since it is capable of measuring the insulation of a module, string or of an entire photovoltaic field **up to 1500V DC** in compliance with standard IEC/EN62446.

Thanks to the new **GFL (Ground Found Locator)** function, the instrument provides the precise position of a possible single fault of low insulation **found on a string** of the PV system due, for example, to water or humidity infiltrations.

- Insulation measurement up to **1500VDC**
- Localization of the **faulty module** in a string through the new **GFL function**
- Continuity of **protective conductors** with 200mA

NEW

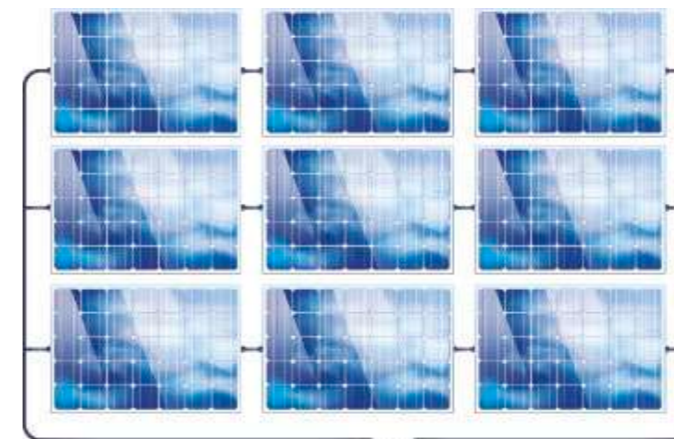

Insulation in DUAL mode
Unearthed PV field

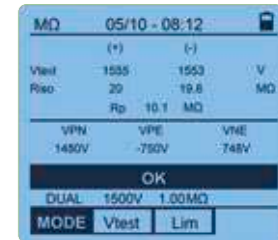

DUAL insulation verification with direct outcome: **OK**



DUAL insulation verification with direct outcome: **NOT OK**

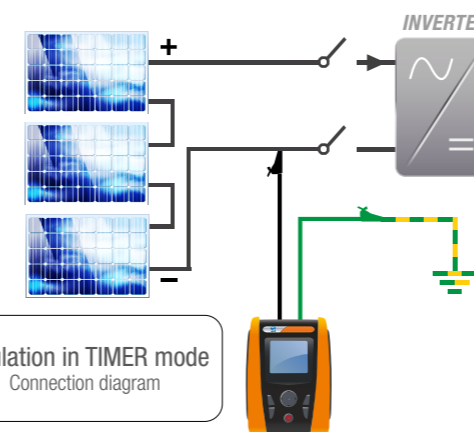

Insulation in TIMER mode
Connection diagram

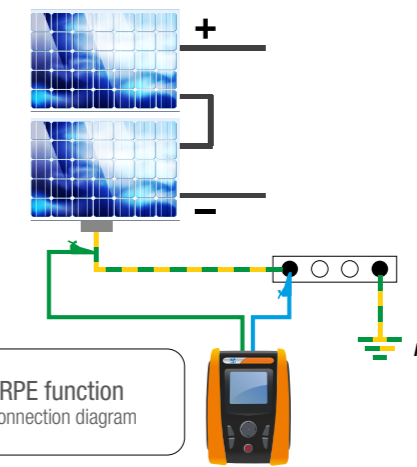

RPE function
Connection diagram



GFL (fault locator) function

Functions

- Continuity of protective conductors with test current 200mA
- Insulation measurement with test voltage 250, 500, 1000, 1500 VDC.
- Measurement of DC voltage up to 1500V
- Measurement of AC TRMS voltage up to 1000V
- Insulation in DUAL and TIMER modes
- GFL function to localize faults on a string
- Calculation of parameters PI (Polarization Index) and DAR (Dielectric Absorption Ratio) on measurements
- Result for every measurement OK/NOT OK
- Compliance with standards IEC/EN61557-2-4
- Internal memory and USB output for PC connection
- Help on line on the display

Main features

Display:	LCD, 128x128pxl, with backlight
Power supply:	6x1.5V alkaline batteries type AA LR06 or 6x1.2V rechargeable NIMH batteries type AA
Auto power off:	after 5 minutes' idling
Internal memory:	Max 999 tests
PC interface:	optical/USB
Safety:	IEC/EN61010-1
Safety of accessories:	IEC/EN61010-031
Measurements:	IEC/EN62446-1
Insulation:	Double insulation
Pollution level:	2
Measurement category:	CAT III 1500VDC, CAT III 1000VAC Max 1500VDC, 1000VAC between inputs
Size:	235x165x75mm
Weight (batteries included):	1.2kg

Provided accessories

KITGSC4	Set of 4 cables + 4 alligator clips
KITPCMC4	Set of 2 adapters with connectors MC4
TOPVIEW2006	Windows software + optical/USB C2006 cable
VA507	Carrying bag
SP-5100	Set of shoulder straps
	ISO calibration report
	User manual and quick guide

Optional accessories

1066-IECN	Connector for extension cables with in/out 4mm banana, black
1066-IECR	Connector for extension cables with in/out 4mm banana, Red
606-IECN	Connector with magnetic terminal, black

YouTube

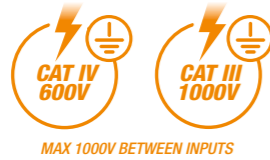

ORDER CODE HV00300N

SOLAR300N

MULTIFUNCTION DEVICE FOR VERIFICATION OF SINGLE-PHASE AND THREE-PHASE PV SYSTEM EFFICIENCY AND POWER QUALITY ANALYSIS IN COMPLIANCE WITH STANDARD EN50160

- New **touchscreen interface**
- Verification of the **efficiency** of the photovoltaic system
- **Analysis of power quality** and **energy consumption**

SOLAR300N tests **single-phase and three-phase photovoltaic systems**. For this kind of tests, it is necessary to guarantee **simultaneity** between power measurements carried out at the inverter and irradiation and temperature measurements carried out on the photovoltaic panels. HT Instruments has introduced a **remote measuring device SOLAR02** which **acquires the values of solar Irradiation [W/m²], panel Temperature [°C] and environmental Temperature [°C]** and transfers them onto SOLAR300N, which inserts them onto the same string of power measurements and then elaborates them with the simultaneity required by the law in force. SOLAR300N is not only a device for testing PV systems, but **also a powerful device for a complete analysis of power quality** according to standard EN50160 (harmonic analysis, voltage anomalies, flickers, unbalance, etc.).

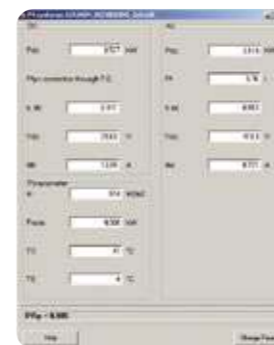

Photovoltaic testing result on PC application TOPVIEW.

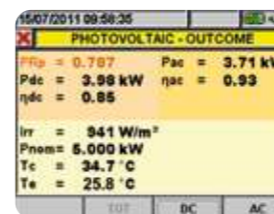

Photovoltaic testing result.



SOLAR300N IS ALSO AN ANALYZER FOR POWER QUALITY AND ENERGY CONSUMPTION

- Harmonics
- Analysis of recordings
- Measurement of energy consumption
- Flicker
- Voltage anomalies and spikes
- Inrush currents
- Vectors and waveforms

Functions

Efficiency measurements of the photovoltaic system

- DC/AC TRMS voltage (single-phase and three-phase)
- DC/AC TRMS current (single-phase and three-phase)
- DC/AC active power (single-phase and three-phase)
- Power factor cosφ (single-phase and three-phase)
- Solar irradiation
- Panel and environmental temperature
- Display of testing result (OK/NOT OK)
- Remote unit SOLAR02 for measuring irradiation and temperature
- Periodic recording of power parameters with programmable PI

Analysis of power and energy consumption

- Recording of voltage and current harmonics (up to the 49th)
- Recording of voltage anomalies (dips, peaks) with resolution 10ms
- Flicker analysis according to EN50160
- Recording of Inrush Currents with resolution 10ms
- Recording of voltage spikes with resolution 5μs
- Complete analysis of power quality according to EN50160
- Touchscreen colour display
- Internal memory and USB output for PC connection
- Power supply with rechargeable Li-ION battery
- Rechargeable internal battery
- Help on line on the display
- Management of USB Pen Drive and compact flash card

Main features

Display:	Colour touchscreen with adjustable brightness
Power supply:	Rechargeable Li-ION, 3.7V battery
Internal memory:	15MB (duration 1 month @ IP=15min, 251 parameters)
External memory:	Compact Flash (CF) card
PC interface:	USB 2.0
Safety:	IEC/EN61010-1
Insulation:	double insulation
Pollution level:	2
Measurement category:	CAT IV 600V (to earth) CAT III 1000V (between inputs)
Unbalance:	IEC/EN61000-4-7
Power quality:	IEC/EN50160
Flicker:	IEC/EN61000-4-15
Reference standard and class:	IEC/EN61000-4-30 Class B
Size:	235x165x75mm
Weight (batteries included):	1kg

Included accessories

SOLAR02	Remote unit for Irradiation and Temperature
KIT800	Set of 5 cables + 5 alligator clips
HT4005K	Standard 200A AC clamp, diameter 40mm (3pcs)
HT4004	Standard 10-100A DC clamp, diameter 32mm
HT304N	Sensor for irradiation measurement
PT300N	PT1000 probe for PV modules temperature
A0055	External AC/DC battery charger power supply 230V 50/60Hz*
YABAT0003HT1	Rechargeable Li-ION battery
PT400	Touch-screen pen
TOPVIEW2007	Windows software + USB C2007 cable
VA500	Rigid carrying case
	User Manual
	Quick guide
	ISO9000 calibration certificate

(* Please check accessory line to find the correct power adapter for your country)

Optional accessories

MPP300	Accessory for (AC) three-phase efficiency verification up to (3MPPT)
HT4005N	Standard AC 0÷5A, 0÷100A clamp, diameter 20mm
HT96U	Standard 1-100-1000A AC clamp, diameter 54mm
HT97U	Standard 10-100-1000A AC clamp, diameter 54mm
HT98U	Standard 1000A DC clamp, diameter 50mm
HP30C2	Standard 200-2000A AC clamp, diameter 70mm
HP30C3	Standard 3000A AC clamp, diameter 70mm
HP30D1	Standard clamp, diameter 83mm 1000A DC
HTFLEX33E*	Flex 3000A clamp, for power analysis, diameter 174mm
HTFLEX35*	Flex 3000A clamp, for power analysis, diameter 274mm
HT903	3x1-5A/1V box for TA connection
SP-0400	Shoulder strap to use the device with free hands
606-IECN	Magnetic connectors for voltage measurement
A0056	115V/50-60Hz power supply with American plug
CF800	1Gb Compact flash card
MCR800	Compact flash card reader

(* can be used only for power analysis)

YouTube



ORDER CODE HV00PVCS

PVCHECKS

MULTIFUNCTION DEVICE FOR COMMISSIONING TESTS OF ELECTRIC SAFETY AND PERFORMANCE OF A PHOTOVOLTAIC SYSTEM

Automatic test in a sequence of:

- **Measurement of insulation** up to 1000V DC
- **Open-circuit voltage** and **short-circuit current Voc/Isc**
- **Continuity of protective conductors** with 200mA

The multifunction device PVCHECKS allows quickly and safely carrying out the commissioning tests provided for a PV system (section in DC) and the functional test of modules/strings in the system consists of according to the requirements of Standard IEC/EN62446.

When testing safety, PVCHECKS is a real innovation, since it is capable of measuring insulation of a module, string or of a whole photovoltaic field (IEC/EN62446) with no need to use an external switch to short-circuit the positive and negative terminals.

PVCHECKS also allows checking the functionality of the connections and of the strings in a photovoltaic field, according to the provisions of standard IEC/EN62446 by measuring the open circuit voltage and the short-circuit current at operating conditions (OPC) and referred to STC (via the optional measurement of irradiation, also with the use of optional accessories SOLAR02 and HT304N), providing an immediate result as regards the measurement just carried out, both in absolute terms and by comparison with the previously tested strings. Finally, PVCHECKS also allows analyzing the performance of the photovoltaic field (DC) under operating conditions (therefore connected to the inverter) with the use of optional accessories SOLAR02 and HT304N, providing an indication of the generated power and of the performance of the field itself.

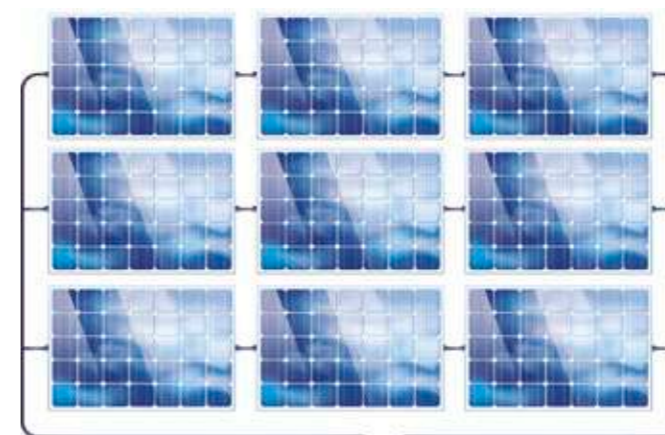

Insulation measurement with method "whole photovoltaic field"



Efficiency measurement of the photovoltaic field

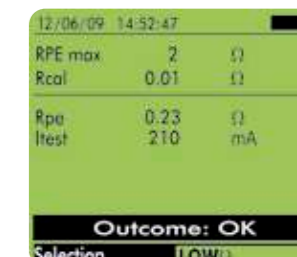

Continuity test result with 200mA OK

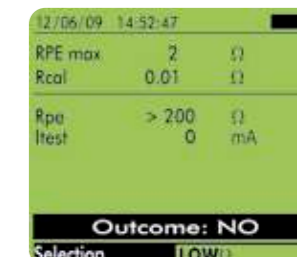

Continuity test result with 200mA NOT OK

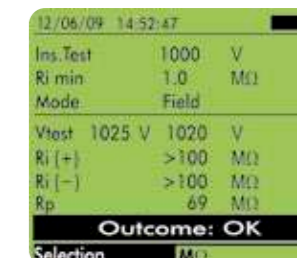

Insulation measurement result at 1000V OK



Automatic sequence test result OK

Functions

Maintenance of photovoltaic system

- Continuity of protective conductors with test current 200mA
- Insulation measurement with test voltage 250,500 and 1000VDC
- Open-circuit voltage (VOC) measurement up to 1000V DC
- Short-circuit current (ISC) measurement up to 15A DC
- DC voltage - DC current - DC power measurement
- Measurement of irradiation [W/m²] through reference cell HT304N
- Environmental and photovoltaic module temperature measurement through PT300N probe
- Use of compensation relationships Cells/Environment on Pdc
- Measurements always compared to the values declared by the module's manufacturer
- Internal database for managing up to 30 PV modules (30.000 modules by software)
- Test measurement of string operation
- Mechanical inclinometer for verifying the correct inclination of sun rays
- Result for every measurement OK/NO
- Internal memory and USB output for PC connection
- Help on line on the display

Efficiency measurements of the photovoltaic system

- Efficiency measurement of the photovoltaic field (DC side)

Main features

Display:	LCD, 128x128pxl, with backlight
Power supply:	6x1.5V alkaline batteries type AA LR06
Auto power off:	after 5 minutes
Internal memory:	256kBytes
PC interface:	optical/USB
Safety:	IEC/EN61010-1
Safety of accessories:	IEC/EN61010-031
Measurements:	IEC/EN 62446
Insulation:	Double insulation
Pollution level:	2
Overvoltage category:	CAT III 1000VDC (to earth) Max 1000V between inputs
Size:	235x165x75mm
Weight (batteries included):	1.2kg

Included accessories

HT4004	Standard 10-100A DC clamp, diameter 30mm
KITGSC4	Set of 4 cables + 4 alligator clips
KITPCMC3	Set of 2 adapters with connectors MC3
KITPCMC4	Set of 2 adapters with connectors MC4
TOPVIEW2006	Windows software + optical/USB C2006 cable
BORSA2051	Soft carrying bag
	ISO9000 calibration certificate
	User manual and quick guide

Optional accessories

PT300N	PT1000 probe for PV modules temperature
SOLAR02	Remote unit for Irradiation/Temperature measurement
HT304N	Reference cell for irradiation measurement
M304	Mechanical inclinometer
SP-0400	Shoulder strap to use the device with free hands
KITPVEXT25M	Set of 2 banana cables 4mm, Green/Black, 25m
606-IECN	Connectors with magnetic terminal

YouTube



MAX 600VAC BETWEEN INPUTS



MAX 1000VDC BETWEEN INPUTS



ORDER CODE **HVMPP300**

MPP300

ACCESSORY FOR MEASURING AND RECORDING THE EFFICIENCY OF A SINGLE- AND THREE-PHASE, SINGLE- AND MULTI-STRING PHOTOVOLTAIC SYSTEM (UP TO THREE MPPT).

- › Simultaneous analysis of **3 strings**
- › **Compatible** with SOLAR300N and SOLAR I-Ve
- › **Integrated rechargeable battery**

MPP300 is an innovative accessory which allows **measuring and recording the main parameters** which characterize single and three-phase, single and multi-string photovoltaic systems (up to three MPPT). Provided with a practical **rigid anti-shock case**, thanks to its **lightness** and its **reduced size** is the ideal solution for on-site use. MPP300 **interfaces** with SOLAR300N and SOLAR I-Ve for its settings, to start/stop recording electric and environmental parameters and to allow for the download of the recorded values. The master devices SOLAR300N or SOLAR I-Ve are only used in the initial and final phase of recording, and they do not play any active role while recording electrical and environmental parameters. Remote unit SOLAR02 (**synchronized** with MPP300) is positioned next to the photovoltaic modules to measure environmental parameters (**irradiation and temperature**). Thanks to this synchronization, **it is not necessary to place long connection cables between the environmental probes and the device** (cables which would impair the operator's movements) **nor to use a wireless connection** between the environmental probes and the device, what is generally impossible due to the attenuation of the signal caused by the presence of floors, reinforced concrete or metal structures.

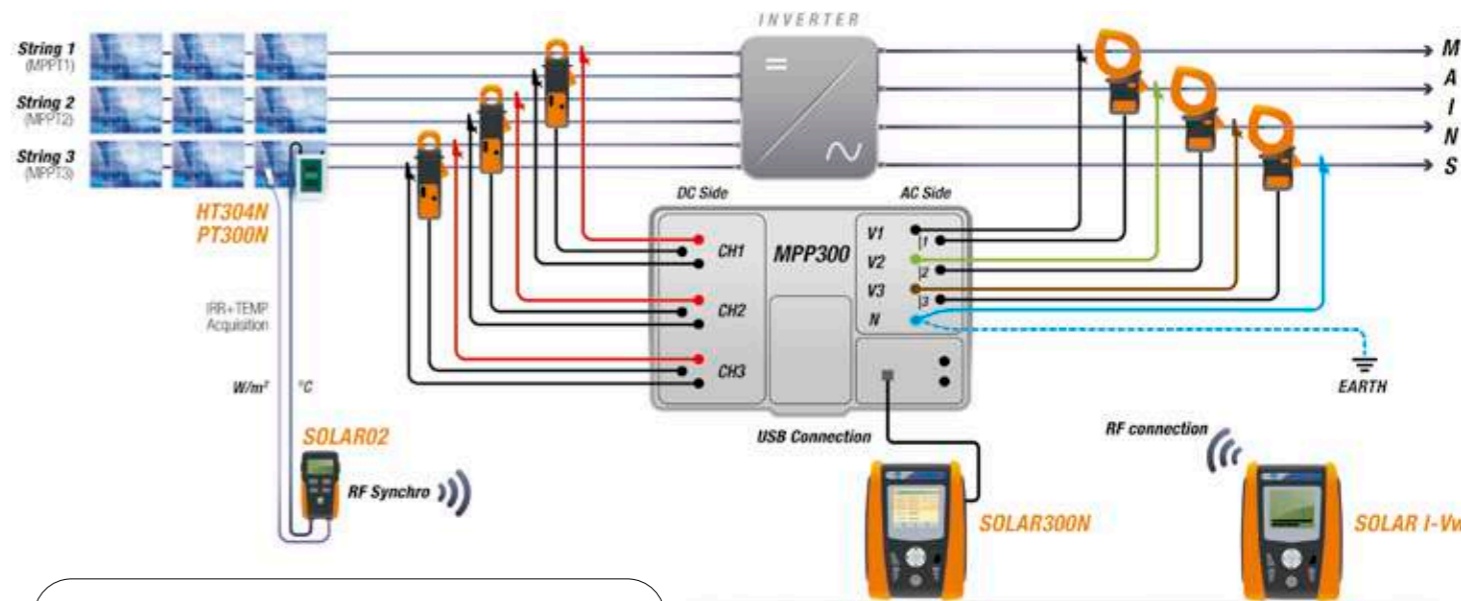

Connection examples:
 › MPP300 + SOLAR300N with USB connection
 › MPP300 + SOLAR I-Ve with RF wireless connection

Synchronization between the two units **guarantees the necessary simultaneity of measurements** and the two separate and independent units make **measurements comfortable and safe under any condition**.

MPP300's **best partner is SOLAR I-Ve**: while MPP300 records the electrical and environmental parameters, it is possible to measure the I-V curves of strings and modules with SOLAR I-Ve, **thus saving time and money**.



- › Practical rigid anti-shock case
- › Small size (mm 300x265x140) for an extreme portability

Functions

- DC/AC TRMS voltage measurement (single-phase and three-phase)
- DC/AC TRMS current measurement (single-phase and three-phase)
- DC/AC power measurement (single-phase and three-phase)
- Simultaneous multi-string tests (max 3 MPPT)
- Connection with master unit SOLAR300N and SOLAR I-Ve
- Power supply with rechargeable Li-ION battery
- LED operating indications
- USB port for connection to unit SOLAR300N
- RF connection for connection to SOLAR02 and SOLAR I-Ve
- Internal memory for saving recordings

Main features

Inputs:	3 DC voltage inputs (CH1, CH2, CH3), 3 DC current inputs (CH1, CH2, CH3), 4 AC voltage inputs (L1, L2, L3, N), 3 AC current inputs (L1, L2, L3)
Front panel:	4 two-colour LEDs (red, green)
Power supply:	Rechargeable Li-Ion battery Duration >3 hours
Internal memory:	2 MBytes
Communication interfaces	USB + RF
Safety:	IEC/EN61010-1
Insulation:	double insulation
Pollution level:	2
Mechanical protection:	IP40 (open), IP65 (closed)
Measurement category:	CAT IV 300 VAC (to earth), 600 VAC (between inputs) CAT III 1000 VDC (to earth), 1000 VDC (between inputs)
Size:	300x265x140mm
Weight (batteries included):	2.3 kg

Included accessories

KITMPPDCW	Set of 2 cables, red and black banana-banana length 2m, 3 pieces
KITMPPDCC	Set of 2 alligator clips, black and red, 3 pieces
KITMPPACW	Set of 4 cables for AC voltage, 2m
KITMPPACC	Set of 4 alligator clips for AC voltage
A0055	External AC/DC battery charger power supply
C2007	USB cable
ACON3F4M	Adapter for the connection of clamps HT98U, HP30D1 and HT4004N, 3 pieces
BORSA2051	Soft carrying bag for accessories
	User Manual
	ISO9000 calibration certificate

Optional accessories

HT4004	Standard 10-100ADC clamp, diameter 32mm
HT4005N	Standard AC 0÷5A, 0÷100A clamp, diameter 20mm
HT4005K	Standard 200A AC clamp, diameter 40mm
HT96U	Standard 1-100-1000A AC clamp, diameter 54mm
HT97U	Standard 10-100-1000A AC clamp, diameter 54mm
HT98U	Standard 1000A DC clamp, diameter 50mm
HP30C2	Standard 200-2000A AC clamp, diameter 70mm
HP30C3	Standard 3000A AC clamp, diameter 70mm
HP30D1	Standard clamp, diameter 83mm 1000A DC
HTFLEX33E	Flex 3000A clamp, for power analysis, diameter 174mm
HTFLEX35	Flex 3000A clamp, for power analysis, diameter 274mm
606-IECN	Magnetic connectors for voltage measurement



POWER QUALITY ANALYZERS

POWER QUALITY ANALYZERS

NEW



MAIN MEASUREMENTS

AC/DC voltage in single-phase/three-phase systems	•	•	•	•	•	• Monofase
AC/DC current in single-phase/three-phase systems	•	•	•	•	•	• Monofase
Cospfi, Power Factor	•	•	•	•	•	• Monofase
Voltage unbalance (NEG%, ZERO%)	•	•	•	•	-	-
Active, reactive, apparent power/energy and DC power	•	•	•	•	•	•
Voltage and current harmonics up to the 49 th with calculation of THD%	•	•	•	•	Only THD	• 25 th
Voltage anomalies (dips, peaks) with a resolution of 10ms (@ 50Hz)	•	•	•	•	-	-
Voltage spikes with a resolution of 5µs (200kHz)	•	-	-	-	-	-
Electric motor starting current (INRUSH)	•	•	-	-	-	•
Voltage flickers (Pst, Plt)	•	•	-	-	-	-
Full analysis EN50160	•	•	-	-	-	-
Phase sequence	•	•	•	•	•	•
Neutral-Ground Voltage	•	•	•	-	-	•
Neutral current	•	•	•	•	-	•

POWER QUALITY ANALYZERS

MEMORY AND RECORDING

Max number of simultaneously selectable parameters	251	251	251	383	44	60
Recording with selectable integration period	1s-60m	1s-60m	1s-60m	5s-60m	5s-60m	1s-15m
Indicative memory duration (in days @ PI=10min @ max number of parameters)	90 days	90 days	90 days	30 days	153 days	50 days
Indication of recording duration	•	•	•	•*	•*	•
Internal memory capacity	15MB	15MB	15MB	8MB	8MB	2MB
External compact flash card	•	•	•	-	-	-
Default and custom recordings	•	•	•	-	-	-
Snapshot saving	•	•	•	•*	•*	•*

REAL-TIME DISPLAY

Summary table of main electric parameters	•	•	•	•*	•*	•*
Voltage/current waveforms	•	•	•	•*	•*	•*
Tables or histograms of Harmonics and THD%	•	•	•	•*	•*	•*
Voltage/current vector diagram	•	•	•	•*	•*	•*

ADDITIONAL CHARACTERISTICS

Measurement category	CAT IV 600V	CAT IV 600V	CAT IV 600V	CAT IV 300V	CAT IV 300V	CAT IV 600V CAT III 1000V
Measurement by means of external CT and VT	•	•	•	•**	•**	-
Touchscreen colour display	•	•	•	-	-	-
Power supply and rechargeable battery recharging	•	•	•	• Auto power supplied	• Auto power supplied	-
Auto power off	•	•	•	•	•	•
USB port for data download onto Pen Drive	•	•	•	• Only PC	• Only PC	-
Provided PC interface with software for Windows	• USB	• USB	• USB	• Wi-Fi / USB	• Wi-Fi / USB	• Wi-Fi
Context help active on each screen	•	•	•	-	-	•
Protection password	•	•	•	-	-	-
Size (LxWxH) (mm)	235x165x75	235x165x75	235x165x75	235x165x75	235x165x75	252x88x44
Weight in kg (batteries included)	1	1	1	0,7	0,7	0,5
Reference standard for mains quality	EN50160	EN50160	-	-	-	-
Reference standard for safety	IEC/EN61010-1	IEC/EN61010-1	IEC/EN61010-1	IEC/EN61010-1	IEC/EN61010-1	IEC/EN61010-1
Order code	HV000824	HV000823	HV000078	HV000820	HV000819	HP009023

* Through App HTANALYSIS and software TOPVIEW.

** Adapter ACONBIN necessary.

PQA824 | PQA823 | VEGA78

THREE-PHASE POWER QUALITY ANALYZERS



PQA824, PQA823 and VEGA78 are three-phase and single-phase power analyzers. They allow for the analysis of all electric parameters which can be measured nowadays, elaborating them easily and quickly.

These devices can be easily programmed thanks to the new colour touchscreen display with icon menu, which guarantees the selection of internal parameters in a simple and intuitive way.

The Help online function available on each screen is a valid and concrete help for the operator in understanding how the devices are used. Each internal parameter is easily reached through the typical tree structure, widely known to Windows system users.

The devices allow displaying the parameters in numerical and graphic mode, both for periodical analysis and for harmonic analysis.

The graphic function "vector diagram" allows, among other things, to immediately evaluate the phase angle between input voltage and current signals, thus defining the loads' nature.

The 15MB internal memory allows saving recorded data for a remarkable number of consecutive days.

PQA824, compared to PQA823 and VEGA78, also allows detecting spikes on input voltages with a minimum resolution of 5µs (200kHz), setting different trigger thresholds which are very useful when solving typical problems on installations (monitoring atmospheric charges, commutations of switching suppliers, disturbance frequencies, etc.)

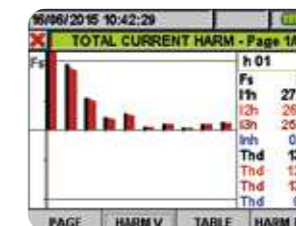

Current harmonics' display in real time.



Display of recorded power graph.

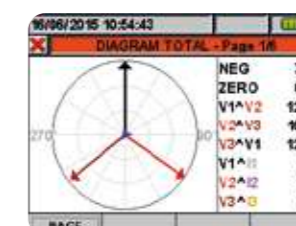

Voltage and current vector diagram.

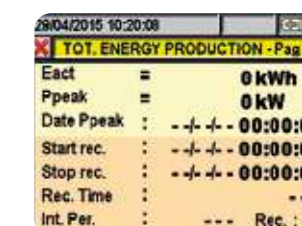

Energy consumption display.

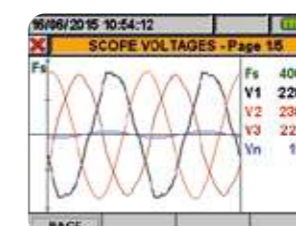

Waveform display (voltage).



General Menu.

Functions

- Simultaneous measurement of power parameters on single-phase and three-phase 3-wire and 4-wire systems
- 5 input channels for voltages and 4 input channels for currents
- Numerical and graphic display (waveforms)
- Voltage and current vector diagram
- Voltage and current harmonic analysis up to the 49th with THD%
- Recording of voltage anomalies (dips, peaks) with 10ms resolution
- Flicker analysis in compliance with EN50160 (**only PQA823 - PQA824**)
- Recording of fast transients (spikes) with resolution 5µs (**only PQA824**)
- Recording of motor starting currents with resolution 10ms (INRUSH) (**only PQA823 - PQA824**)
- Voltage unbalance (NEG%, ZERO%)
- Integration period selectable from 1s to 60min
- Preset and custom recordings
- Touchscreen colour display
- Power supply with rechargeable Li-ION battery
- Memory extension with external Compact Flash card
- Possibility of connecting an external pen drive
- PC interface with USB port

Main features

Display:	TFT, 65536 colours, (320x240pxl) with high contrast, touch screen
Power supply:	1x3.7V rechargeable Li-ION battery, with external adapter, duration >6h, auto power of after 5 minutes' idling
Internal memory:	15Mbytes (duration approx. 3 months @ IP=15min and 251 selectable parameters)
Memory extension:	external Compact Flash card (ca. 32Mb)
PC interface:	USB 2.0
Safety:	IEC/EN61010-1
Insulation:	double insulation
Measurement category:	CAT IV 600V (Phase - Neutral) CAT IV 1000V (between inputs)
Power quality and Flicker:	EN50160
Electric energy quality:	EN61000-4-30, class B
Unbalance:	EN61000-4-7, EN50160
Size:	235x165x75mm
Weight (battery included):	approx 1kg

Included accessories

HTFLEX33E	Flex clamp 3000A, diameter 174mm, 4 pieces
KIT800	Set of 5 cables + alligator clips
A0055	AC/DC battery charger power supply 230V 50/60Hz*
YABAT0003HT1	Rechargeable 3.7V Li-ION battery
PT400	Touch-screen pen
TOPVIEW2007	Windows software + USB cable
VA500	Rigid Soft carrying bag
	User manual on CD-ROM
	Quick user guide
	ISO9000 calibration certificate

(* Please check accessory line to find the correct power adapter for your country)

Optional accessories

HTFLEX35	Flex 3000A AC clamp, diameter 274mm
HT96U	Standard 1-100-1000A AC clamp, diameter 54mm
HT97U	Standard 10-100-1000A AC clamp, diameter 54mm
HT98U	Standard 1000A DC clamp, diameter 50mm
HP30C2	Standard 200-2000A AC clamp, diameter 70mm
HP30C3	Standard 3000A AC clamp, diameter 70mm
HT4005N	Standard 5-100A AC clamp, diameter 20mm
HT903	3x1-5A/1V box for external TA connection
A0056	External power supply 110VAC-60Hz /12VDC
CF800	1GB Compact Flash Card
MCR800	Compact flash card reader
606-IECN	Connector with magnetic terminal
SP-0400	Set of straps for slinging the instrument over one's shoulder

ORDER CODE HV000820 | HV000819

PQA820|PQA819

THREE-PHASE AND SINGLE-PHASE POWER QUALITY ANALYZERS



PQA820 e PQA819 are the **innovative** proposal by HT to **easily analyze** all involved components on a **three-phase** or **single-phase** electric system.

When designing them, HT has taken particular care of three aspects: **setting**, the operating or storage environment and data transfer.

- PQA820 and PQA819 **do not need to be set**. They simply need to be connected, started and they respectively record 383 and 44 quantities simultaneously.
- They are provided with a comfortable **IP65** case, which allows working in **any kind of environment**.
- When recording has finished, **thanks to the Wi-Fi connection**, the devices are capable of transferring all data onto a **tablet, smart phone** or **PC**.

Further to the Wi-Fi connection, PQA devices are provided with USB connection for transferring data via cable to the PC through **the provided TopView software**.

They do not need any batteries since they are **auto power-supplied** from the power they are analyzing.

The **internal battery is automatically recharged** by the input voltage and will provide the necessary energy to **go on recording** in **case power supply is interrupted**.

To make the most of the technology used by PQA820 and PQA819 we recommend using the **HTAnalysis App** (available for **free download** on AppStore and Google Play) on a tablet or smart phone.

Here are some of the functions of HTAnalysis:

- Display of measured data on high-definition screen.
- Possibility of "scrolling" through a determined waveform and immediately detecting its critical "moments": it will be sufficient to "touch" a certain spot of the screen in which the measured signal is proposed to immediately obtain all necessary information in order

to understand what happened in that spot and in that particular moment!

PQA820 and PQA819 respectively record 383 and 44 quantities which can be **recalled and dragged onto the screen** to be **compared between each other**; for example, if you are displaying the trend of voltages and **you want to check for the possible presence of harmonic distortion**, it will be sufficient to scroll through the list of recorded measures and **drag the one relevant to harmonics to the screen**.

The same can be done for all other quantities: **power, cosphi, current, energy**, etc.

Everything can then be shared on **HT Cloud**, the web database created by HT to **archive** recordings and **share them** quickly with anyone around the world. Through **HTCLOUD™** you will be able to **share all measurements with you colleagues** and/or download them from any PC/Mobile device connected on the web.



IP65 - Waterproof and resistant to extreme conditions.

Functions

- AC TRMS voltage in single-/three-phase systems
- AC TRMS current in single-/three-phase systems
- Active, Reactive and Apparent Power/Energy
- Cosphi and Power Factor
- Voltage, Current, DC Power
- Neutral current (**only PQA820**)
- Voltage dips and peaks on 10ms (**only PQA820**)
- Voltage unbalance (NEG%, ZERO%) (**only PQA820**)
- Measurements using external CT and VT
- Voltage/current waveforms
- Histograms of voltage/current harmonics and THD%
- Voltage/current vector diagram
- Periodical recording with selectable PI
- Maximum number of simultaneously recorded quantities
PQA820: 383 PQA819: 44
- Voltage and current harmonic analysis up to the 49th
- Calculation and recording of voltage/current THD%
- Indication of recording duration

Main features

- Power supply:** rechargeable Li-ION battery
- External power supply:** 100 ÷ 415V, 50/60Hz
- Recording duration** > 30 days (@ PI = 10min) (**PQA820**)
> 230 days (@ PI =15min) (**PQA819**)
- Recording period:** 5, 10, 30s, 1, 2, 5, 10, 15, 60min)
- PC interface:** USB 2.0 and Wi-Fi
- Safety:** IEC/EN61010-1, double insulation
- Mechanical protection:** IP65 (closed case)
- Measurement category:** CAT IV 300V, max 415V between inputs
- Reference standards:** EN50160
- Operating temperature:** 0 ÷ 40°C
- Operating humidity:** <80%RH
- Storage temperature:** -10 ÷ 60°C
- Storage humidity:** <80%RH
- Size:** 235x165x75mm
- Weight (battery included):** approx 0.7 kg

Included accessories

KITMPPACW	Set of 4 measuring cables
KITMPPACC	Set of 4 alligator clips
606-IECN	Adapters with magnetic terminal (4x)
HTFLEX33L	Flex 1000A AC clamp, diameter 174mm (4x)
TOPVIEW2007	PC Windows software + USB cable
BORSA2051	Soft carrying bag for accessories
	Quick user guide
	ISO9000 calibration certificate
	User manual on CD-ROM

Optional accessories

HT96U	AC clamp for leakage current, 1-100-1000A/1V, diameter 54mm
HT97U	Standard 10-100-1000A AC clamp, diameter 54mm
HT98U	DC clamp for leakage current, 1000A/1V, diameter 50mm
HP30C2	Standard AC 200-2000A/1V clamp, diameter 70 mm
HP30D1	Standard DC 1000A/1V clamp, diameter 83 mm
HT903	3x1-5A/1V box for connection to external CT
ACONBIN	Adapter for the connection of standard clamps

GSC60 | PQA820 | PQA819 | HT9023 WITH HTANALYSIS™

More information on [page 38](#)

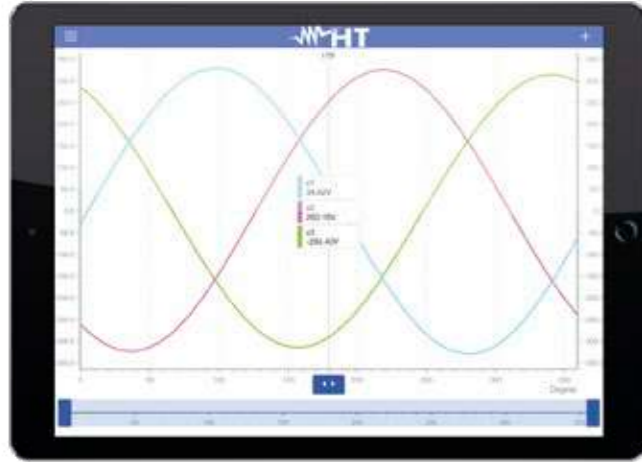

Voltage and current waveforms.

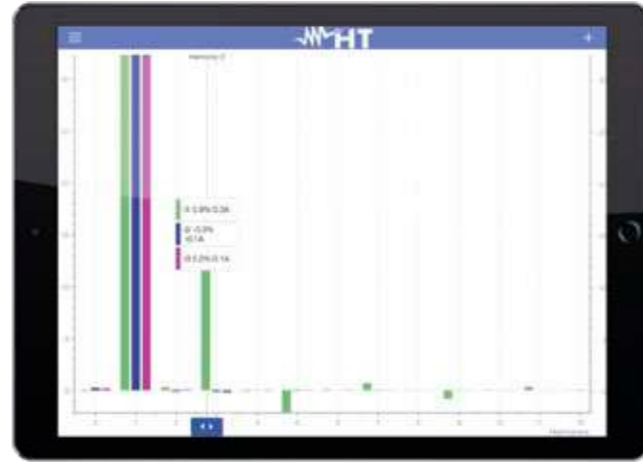

Current and voltage harmonics.

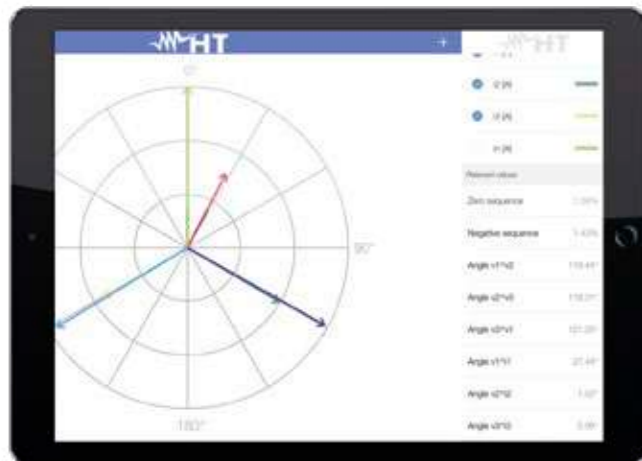

Voltage and current vector diagram.

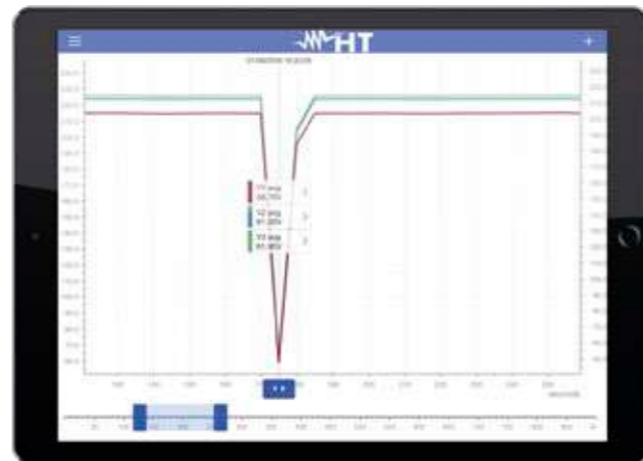

Zoom on a voltage and current drop.



Jump function
1 Click on the arrow next to the desired value.



Jump function
2 It switches to harmonic values in real-time.



- CAT IV 600V
CAT III 1000V
- TRMS
- DYNAMIC INRUSH
- HT Cloud
- HTAnalysis™
- WiFi
- YouTube

ORDER CODE **HP009023**

HT9023

PROFESSIONAL CLAMP METER FOR MEASURING POWER/HARMONICS WITH WIFI CONNECTION

HT9023 has been designed to measure AC, DC AC+DC current up to 1000A in TRMS reaching CAT IV 600V and CAT III 1000V in compliance with safety standard IEC/EN61010-1. The clamp also measures DC voltage up to 1500V, AC, AC+DC voltage up to 1000V, Active, Reactive and Apparent Power, Power Factor, Energy, voltage/current harmonic analysis up to the 25th with THD% calculation in balanced single-phase or three-phase systems. It is also possible to carry out the phase sequence test with 1-terminal. The instrument also detects the events linked to motor starting currents (Dynamic INRUSH) and allows recording each measured electric parameter over time, with the possibility of transferring data via WiFi to Android/iOS devices through the HTAnalysis App or onto PC through the TOPVIEW software. The clamp is provided with a wide graphic dot-matrix screen (128x128pxl) with backlight, in order to allow reading data even in poorly lit environments, and it is provided with an auto power off function to preserve its internal battery.

Functions

- DC, AC + DC TRMS current up to 1000A
- DC voltage up to 1500V
- AC, AC+DC TRMS voltage up to 1000V
- Resistance and Continuity test
- "Voltsense" for AC voltage detection
- Frequency with clamp jaws and leads
- Phase sequence / phase concordance with 1 terminal
- Measurement/recording of DC power and energy
- Active, reactive, apparent power meas./rec. in single-phase system
- Active, reactive power meas./rec. in single-phase systems
- Power factor measurement/recording in single-phase systems
- Measurement/Recording of voltage/current harmonics up to the 25th and calculation of THD%
- Motor starting current detection (Dynamic INRUSH)
- Data logger function with programmable PI
- Autorange
- Data HOLD
- MAX/MIN/AVG
- PEAK (1ms)
- ZERO
- Backlight
- WiFi for connection to PC and Android/iOS devices
- Auto Power OFF

Main features

Display:	dot-matrix 128x128pxl with backlight
Conversion type:	TRMS
Power supply:	2x1.5V batteries type AAA LR03
Duration:	> 40ore
Internal memory:	2MBytes (ca. 5g @IP=1 min)
PC interface:	WiFi
Clamp jaw internal diameter:	45mm
Safety:	IEC/EN61010-1
Measurement category:	CAT IV 600V - CAT III 1000V
Insulation:	double insulation
Pollution level:	2
Size (LxWxH):	252x88x44mm
Weight (batteries included):	420g

Accessories provided

YAAMK0000HTO	Pair of test leads
YAAMK0001HTO	Pair of alligator clips
TOPVIEWS	Windows software for PC connection
YABRS0000NNO	Carrying bag
	Batteries
	ISO9000 calibration certificate
	User manual on CD-ROM
	Quick user guide

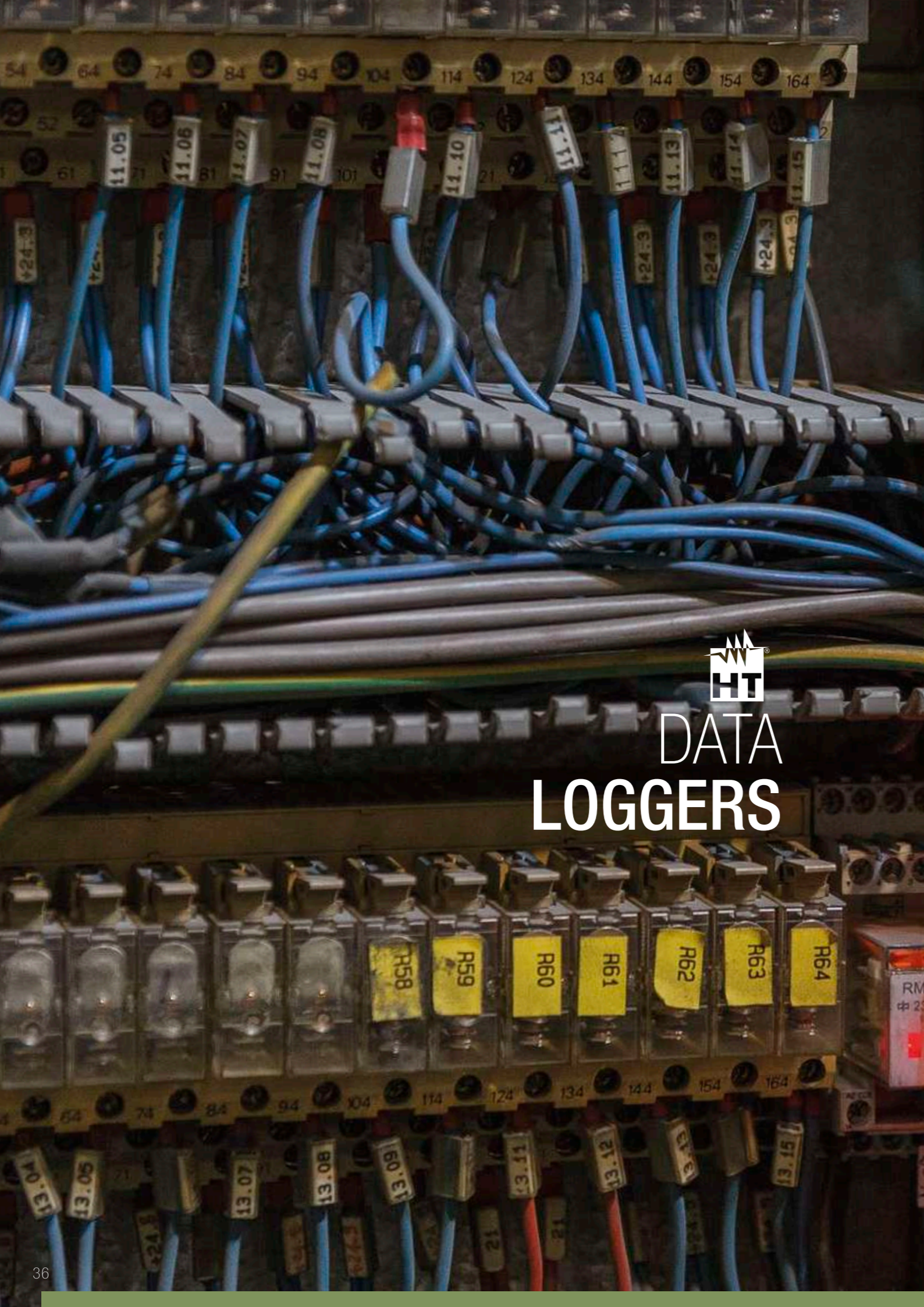

DATA LOGGERS

DATA LOGGERS



MAIN MEASUREMENTS

TRMS

AC voltage in single-phase/three-phase systems

AC current in single-phase/three-phase systems

MEMORY AND RECORDING

Max number of simultaneously selectable parameters

Recording with selectable integration period

Indicative memory duration (single-/three-phase in days @ PI=5min)

Internal memory capacity

DATA LOGGERS

	XL421	XL422	XL423	XL424
AC voltage in single-phase/three-phase systems	-	-	Single-phase	Single-phase / three-phase
AC current in single-phase/three-phase systems	Single-phase	Single-phase / three-phase	-	-
Max number of simultaneously selectable parameters	1	3	1	3
Recording with selectable integration period	1s, 6s, 30s, 1min, 5min	1s, 6s, 30s, 1min, 5min	1s, 6s, 30s, 1min, 5min	1s, 6s, 30s, 1min, 5min
Indicative memory duration (single-/three-phase in days @ PI=5min)	455	455 / 1820*	455	455 / 1820*
Internal memory capacity	1MB	1MB	1MB	1MB
ADDITIONAL CHARACTERISTICS				
Protection rating	IP65	IP65	IP65	IP65
Measurement category	CAT IV 600V CAT III 1000V	CAT IV 600V CAT III 1000V	CAT IV 600V CAT III 1000V	CAT IV 600V CAT III 1000V
Power supply	2x Batteries AA	2x Batteries AA	2x Batteries AA	2x Batteries AA
Provided PC interface with software for Windows	•	•	•	•
Size (LxWxH) (mm)	120x80x43	120x80x43	120x80x43	120x80x43
Weight (batteries included)	500g	500g	500g	500g
Reference standard for safety	IEC/EN61010-1	IEC/EN61010-1	IEC/EN61010-1	IEC/EN61010-1
Order code	HV000421	HV000422	HV000423	HV000424

* According to battery duration.



ORDER CODE HV000421 | HV000422

XL421 | XL422

TRMS SINGLE-PHASE AND THREE-PHASE CURRENT DATA LOGGER

XL421 and XL422 are **Data Loggers** capable of measuring and recording the true root mean square (TRMS) value of AC current up to 2500A AC in, according to the model single-phase or three-phase, electric systems for different applications (evaluation of load currents, rated powers of transformers, etc.). The devices have a comfortable mobile structure with integrated flex clamp jaws which allow surrounding also a big-sized cable or bar. Thanks to an advanced memory management algorithm it is possible to monitor a system even for a long time. The devices start recording with a **sampling period** which can be selected through software among 1, 6, 30 and 60 seconds and, when memory is almost full, the previously recorded values are "re-sampled" according to the subsequent value of the sampling period, thus freeing part of the memory; the devices then go on recording new values, using the new measuring interval. In this way, it is possible to keep the device recording up to **approximately 1 year according to the model**. Each recording is kept stored in the internal memory and can be **downloaded and managed by PC** always through a dedicated software. A special adhesive strap is also provided with the devices, which makes it possible to place them in any place in the installation where measuring is needed. The high protection rating (IP65) makes these devices fully reliable also under extreme operating conditions.



TRMS



ORDER CODE HV000423 | HV000424

XL423 | XL424

TRMS SINGLE-PHASE AND THREE-PHASE VOLTAGE DATA LOGGER

XL423 and XL424 are **Data Loggers** capable of measuring and recording the true root mean square (TRMS) value of Voltage up to 600V AC or, according to the model, in single-phase or three-phase electric systems, for different applications (evaluation of mains voltage, load unbalance, etc.). The devices have a comfortable mobile structure with integrated flex clamp jaws which allow surrounding also a big-sized cable or bar. Thanks to an advanced memory management algorithm it is possible to monitor a system even for a long time. The devices start recording with a **sampling period** which can be selected through software among 1, 6, 30 and 60 seconds and, when memory is almost full, the previously recorded values are "re-sampled" according to the subsequent value of the sampling period, thus freeing part of the memory; the devices then go on recording new values, using the new measuring interval. In this way, it is possible to keep the device recording up to **approximately 1 year according to the model**. Each recording is kept stored in the internal memory and can be **downloaded and managed by PC** always through a dedicated software. A special adhesive strap is also provided with the devices, which makes it possible to place them in any place in the installation where measuring is needed. The high protection rating (IP65) makes these devices fully reliable also under extreme operating conditions.



TRMS

Functions and characteristics

- TRMS single-phase current measurement (XL421)
- TRMS three-phase current measurement (XL422)
- Measuring range: 1 ÷ 2500A AC
- Accuracy: ±(1.0%reading+1 digit)
- Resolution: 1A
- Operating frequency: 50±6Hz, 60±6Hz
- Bandwidth: 3200Hz
- Sampling frequency: 64 spots in 20ms
- Integration period: 1s, 6s, 30s, 60s, 5min
- Memory capacity: 1Mbyte
- Serial interface: RS-232
- Integration period.....duration in days:
 - 1s.....5 (XL421) 1,5 (XL422)
 - 6s.....34 (XL421) 8 (XL422)
 - 30s.....170 (XL421) 42 (XL422)
 - 60s.....364* (XL421) 91 (XL422)
 - 5min1820* (XL421) 455* (XL422)
- Front panel indication: LED diodes
- Power supply: 2x1.5V batteries type AA LR6
- Battery life: >6months (with loaded batteries)
- Safety: IEC/EN 61010-1
- Measurement category: CAT IV 600V (to earth)
- Insulation: Double insulation
- Pollution level: 2
- Mechanical protection index: IP65
- Max height: 2000m
- Max diameter of flex clamps: 174mm
- Size (LxWxH): 120x80x43 mm
- Weight (batteries included): approx. 0.5kg

* According to battery duration

Included accessories

VELCRO	Adhesive strap 50x70mm
TOPVIEW2004	Windows software for PC + serial cable C2004
BORSA 2000	Soft carrying bag (XL421)
BORSA75	Soft carrying bag (XL422)
	Batteries
	User Manual

Optional accessories

C2009	RS232-USB adapter
-------	-------------------

Functions and characteristics

- TRMS single-phase voltage measurement (XL423)
- AC TRMS three-phase voltage measurement (XL424)
- Measuring range: 0 ÷ 600VAC
- Accuracy: ±(1.0%reading+1 digit)
- Resolution: 0,1V
- Operating frequency: 50±6Hz, 60±6Hz
- Bandwidth: 3200Hz
- Sampling frequency: 64 spots in 20ms
- Integration period: 1s, 6s, 30s, 60s, 5min
- Memory capacity: 1Mbyte
- Serial interface: RS-232
- Integration period.....duration in days:
 - 1s.....5 (XL423) 1,5 (XL424)
 - 6s.....34 (XL423) 8 (XL424)
 - 30s.....170 (XL423) 42 (XL424)
 - 60s.....364* (XL423) 91 (XL424)
 - 5min1820* (XL423) 455* (XL424)
- Front panel indication: LED diodes
- Power supply: 2x1.5V batteries type AA LR6
- Battery life: >6months (with loaded batteries)
- Safety: IEC/EN 61010-1
- Measurement category: CAT IV 600V (to earth)
- Insulation: Double insulation
- Pollution level: 2
- Mechanical protection index: IP65
- Max height: 2000m
- Size (LxWxH): mm 120x80x43
- Weight (batteries included): approx. 0.5kg

* According to battery duration

Included accessories

KITXL424C	Set of 4 alligator clips
VELCRO	Adhesive strap 50x70mm
TOPVIEW2004	Windows software for PC + serial cable C2004
BORSA2000	Soft carrying bag
	Batteries and User Manual

Optional accessories

C2009	RS232-USB adapter
606-IECN	Connector with magnetic terminal

HTAnalysis™ **HTANALYSIS**
Artificial Intelligence.



With the latest-generation HT devices it is possible to interface with tablets and smartphones by using the **HTAnalysis App**. HTAnalysis is a professional software which allows displaying and consulting, on your mobile devices, **measured and recorded data**, and then **share them** with the **HTCloud** database. HTAnalysis allows generating professional reports complete with images, texts, videos and voice notes. By interfacing the device with your mobile device's display, the touch-screen interaction will allow quickly displaying a detailed report of the trend of the recorded quantities.

WITH
**GSC60, MacroTestG3, G2, G1
and CombiG2**

- Generate reports complete with photos, videos, text and voice notes.
- Archive reports in the **HTCloud** database.

WITH
SOLAR I-Ve, I-V 500w and I-V400w

- Display and analyze the I-V curves downloaded from the instrument, attach photos, videos, text and voice notes.

WITH
**GSC60, PQA820,
and PQA819**

- Display voltage, current, power, harmonics, THD%, cosphi and frequency.
- Observe in real time all waveforms, vector diagrams and harmonics.
- Archive readings in the **HTCloud** database.

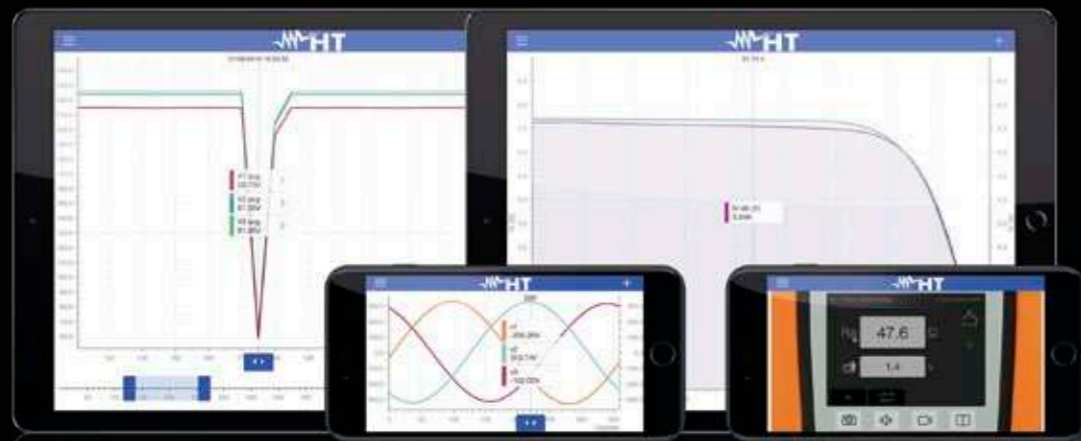

HT Cloud **HTCLOUD**
Share everything.
When, how and where you like.

Install the HTAnalysis App to **access** the **HTCloud** database to archive and **share** measured and recorded data with colleagues and partners **from all around the world**.



HT
**MULTIFUNCTION
INSTALLATION
TESTERS**

**MULTIFUNCTION
INSTALLATION
TESTERS**

**DEVICES LAN
NETWORKS**

NEW

NEW



MACROTEST G3



MACROTEST G2



MACROTEST G1



GSC60



COMBI G2



COMBI 420/421



COMBI 419



M75



M74



JUPITER



NEPTUNE



FULLTEST3

ELECTRIC SAFETY MEASUREMENTS	ELECTRIC VERIFICATIONS MAINS ANALYSES					ELECTRIC VERIFICATIONS MAINS ANALYSES			ELECTRIC VERIFICATIONS TRMS MULTIMETER				ELECTRIC DEVICES AND ELECTRIC PANELS
TRMS	•	•	•	•		•	•	•	•	•	•	•	•
Insulation with voltage 50, 100, 250, 500, 1000VDC	•	•	-	•		•	•	•	• 250V, 500V	• 250V, 500V	-	•	•
Continuity of protective conductors with 200mA / 10A	• 200mA	• 200mA	• 200mA	• 200mA		• 200mA	• 200mA	• 200mA	• 200mA	• 200mA	-	• 200mA	•
Tripping time of RCDs type B, A, AC Standard, Selective and Delayed up to 1A	•	-	-	•		•	• Only A, AC standard and selective	• Only A, AC standard and selective	• A = 30mA AC = 300mA Only standard	• A = 30mA AC = 300mA Only standard	• Only A, AC standard up to 300mA	-	•
Tripping current of type B, A, AC Standard, Selective	• A, AC = 1A B = 300mA	-	-	• A, AC = 1A B = 300mA		• A, AC = 1A B = 300mA	• Only A, AC standard and selective	• Only A, AC standard and selective	• A = 30mA AC = 30mA Only standard	• A = 30mA AC = 30mA Only standard	• Only A, AC standard 30mA	-	• 1A
Tripping time and current of earth leakage relays type B, A, AC Standard, Selective and Delayed up to 10A	•***	-	-	•***		•***	-	-	-	-	-	-	-
Non-trip earth resistance	•	-	-	•***		•	•	•	•	•	•	-	•
Earth resistance by voltammetric method	•	•	•	•		-	-	-	-	-	-	-	-
Earth resistance by stakeless testing method	•**	•**	•**	•**		-	-	-	-	-	-	-	-
Ground resistivity by 4-wire method	•	•	•	•		-	-	-	-	-	-	-	-
Loop/Line impedance, Phase-Phase, Phase-Neutral, Phase-PE	•	-	-	•		•	•	•	-	-	•	-	•
Loop/Line impedance Phase-Phase, Phase-Neutral, Phase-PE with high resolution (0.1mΩ)	•*	-	-	•*		•*	•*	•*	-	-	-	-	•
Measurement of percentage voltage drop on the line	•	-	-	•		•	-	-	-	-	-	-	-
Contact voltage	•	-	-	•		•	•	•	•	•	•	-	-
Wire mapping of LAN cables with RJ45 plug	-	-	-	-		-	-	-	•	•	•	-	-
Phase sequence	•	-	-	•		•	•	•	•	•	•	•	-
Leakage current with optional clamp meter	•	-	-	•		•	•	•	•	•	-	•	-
Dielectric strength with test voltage up to 5100V AC	-	-	-	-		-	-	-	-	-	-	-	•
Measurement of discharge time of internal capacitances	-	-	-	-		-	-	-	-	-	-	-	•
Measurement of Polarization Index (PI) and Dielectric Absorption Ratio (DAR)	-	-	-	-		-	-	-	-	-	-	•	-
MAINS ANALYSIS													
Measurement of Voltage, Current, Active, Reactive, Apparent Power	• (1)	• (1)	-	• (3) with Recording		• (1)	• (1)	-	-	-	-	-	• (1)
Measurement of Cosphi, Power Factor	• (1)	• (1)	-	• (3) with Recording		• (1)	• (1)	-	-	-	-	-	• (1)
U/I harmonics up to the 49 th +THD% + Voltage anomalies	• 25 th no Anomalies	• 25 th no Anomalies	-	• (3) with Recording		• 25 ^a	• 49 ^a	-	-	-	• 25 th no Anomalies	• 25 th no Anomalies	-
ADDITIONAL CHARACTERISTICS													
Measurement category	CAT IV 300V	CAT IV 300V	CAT IV 300V	CAT IV 300V to earth max 600 between inputs		CAT III 240V	CAT III 240V	CAT III 240V	CAT III 550V	CAT III 550V	CAT IV 600V CAT III 690V	CAT IV 600V CAT III 1000V	CAT III 300V CAT II 300V
DC/AC TRMS voltage and current, Frequency, Resistance, Continuity with buzzer	-	-	-	-		-	-	-	•	•	•	•	-
AUTOMATIC test (Ra, RCD, Insulation)	•	-	-	-		•	•	•	•	•	-	-	-
Measurement of environmental parameters (°C, °F, %RH, Lux)	•	-	-	• with Recording		•	•	-	-	-	-	-	-
Test with remote lead PR400	•	•	•	•		•	•	•	-	-	-	-	-
Help on line on the display	•	•	•	•		•	•	•	-	-	-	-	-
Internal memory	•	•	•	•		•	•	•	-	-	-	-	•
Optical/USB serial port for PC connection	•	•	•	•		•	•	•	-	-	-	-	• USB
Built-in WiFi connection and compatibility with HTANALYSIS App	•	•	•	•		•	-	-	-	-	-	-	-
Size (LxWxH) (mm)	222x162x57	222x162x57	222x162x57	222x162x57		222x162x57	222x162x57	222x162x57	240x100x45	240x100x45	175x85x55	175x85x55	400x300x170
Weight (batteries included)	1.2 kg	1.2 kg	1.2 kg	1.2 kg		1.2 kg	1.2 kg	1.2 kg	450g	450g	420g	420g	15kg
Reference standard for safety	IEC/EN61010-1	IEC/EN61010-1	IEC/EN61010-1	IEC/EN61010-1		IEC/EN61010-1	IEC/EN61010-1	IEC/EN61010-1	IEC/EN61010-1	IEC/EN61010-1	IEC/EN61010-1	IEC/EN61010-1	IEC/EN61010-1
Order code	HV005036	HV005038	HV005037	HV000060		HV0000G2	HV004210 (421) HV000420 (420)	HV000419	HV000075	HV000074	HR00JUPI	HR00NEPK	HV000003



ORDER CODE HV000060

GSC60

A UNIQUE INSTRUMENT FOR MAINS ANALYSIS
AND VERIFICATION OF ELECTRIC SAFETY

GSC60 is the only device in the world which can perform the verification of electric safety and the analysis of single-phase/three-phase mains and electric consumption. It has been designed to make the safety of electric system **visible, understandable and assessable** in a **simple and quick** way. Thanks to the new **operating system HTOS™ 2.0**, once measurement is complete, the operator receives from the device a message **OK - NOT OK** which communicates whether the part of the tested system is compliant and, therefore, safe. The user interface, totally renewed in HTOS™, allows setting and carrying out measurements in a few simple steps. All recorded data are **saved** and, for each kind of test, it is possible to **create folders and subfolders** and, with the virtual keyboard, **add comments and notes**. But, even better, through the FREE APP HTAnalysis, **compatible with iOS and Android**, the measurements carried out **can be transferred via Wi-Fi onto smartphone or tablet** and, thanks to this function, it is possible to attach **a picture, a video or a voice note** to every measurement. GSC60 is also a **three-phase mains and electric consumption analyzer** which is unique thanks to the APP HTAnalysis.

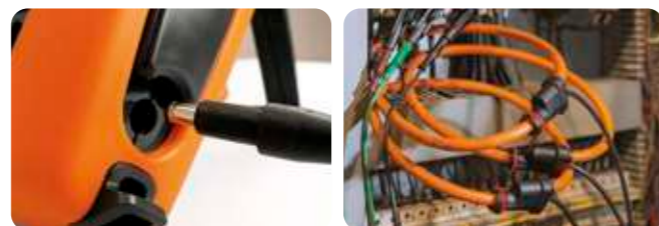

Power supply and on-board battery charger.

Flexible jaws for current measurement.

Global Connection.

Thanks to WiFi capability you can easily transfer data and get through App **HTANALYSIS™**. You can check your test results, save them on **HTCloud™** or send them by email. Your working team will be always in touch.

Full Batteries at All Times.

GSC60 is so compact that a new power technology had to be designed to charge batteries. You just need to power the unit and it will charge the batteries. Or you can always start working by simply replacing them with standard AA batteries.

HTOS™ Managing the Power.

Get access through touchscreen to your measurement. Quickly set measurement parameters and press GO. Here it is, **HTOS™**, designed to make your work easier. Its' result options **OK** and **NOT OK** as well as its **Help OnLine** will make it your best partner and save you time.

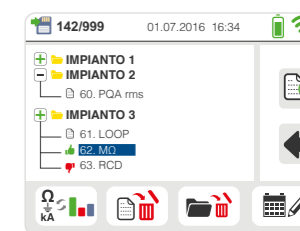
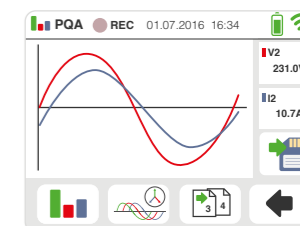
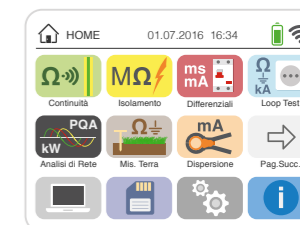

Example of display
Harmonics V-I



Example of display
Real-time phasors

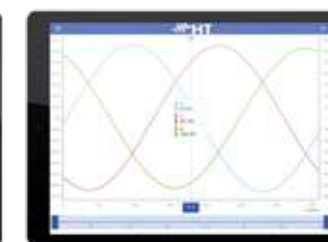

Example of display
Waveforms V-I

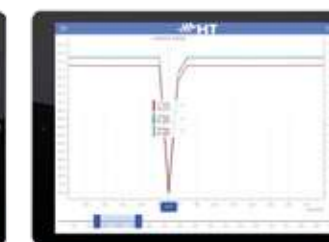

Example of display
Recording made
(evident voltage interruptions)

Functions of Electric safety

- Insulation with test voltage 50, 100, 250, 500, 1000 VDC
- Continuity of protective conductors with 200mA
- Earth resistance by voltammetric method
- Resistance of the earth rods with clamp
- Ground resistivity by 4-wire method
- Overall earth resistance with no residual current protection tripping
- Line/Loop, Phase-Phase, Phase-Neutral, Phase-PE impedance
- Line/Loop, Phase-Phase, Phase-Neutral, Phase-PE impedance with high resolution (0.1 mΩ) with optional accessory IMP57
- Assumed short-circuit current
- Contact voltage
- Tripping time of General, Selective and Delayed RCDs
- Test current A, AC max 1A and type B max 300mA
- Test on RCDs with separate clamp jaw up to 10A
- RCD tripping current (Ramp test)
- Phase sequence
- Measurement of percentage voltage drop on the lines
- Test with remote switch probe PR400
- Leakage current (with optional clamp HT96U)
- Help on line on the display
- Internal memory for measured data saving
- Optical/USB serial port for PC connection
- Built-in WiFi communication interface

Functions of Mains analysis

- 9 types of electric systems available: 1Φ-2 wires, 1Φ-centr. socket, 3Φ-3 wires, 3Φ-Aron, 3Φ-Δ Open, 3Φ-Y Open, 3Φ-2 el. 1/2, 3Φ-4 wires Y, 3Φ-High Leg.
- AC TRMS voltage in single-/three-phase systems up to 600V
- AC TRMS current in single-/three-phase systems up to 3000A
- Active, Reactive and Apparent Power/Energy
- Cosphi and Power Factor
- Voltage, Current, DC Power
- Measurement of neutral current
- Voltage dips and peaks on 20ms @50hz
- Voltage unbalance (NEG%, ZERO%)
- Measurements using external TA and TV
- Voltage/current waveforms
- Histograms of voltage/current harmonics and THD%
- Voltage/current vector diagram
- Periodical recording with selectable PI
- Max number of simultaneously selectable quantities 632
- Voltage/current harmonic analysis up to the 49th
- Calculation and recording of voltage/current THD%
- Indication of recording duration

Included accessories

HTFLEX33E	AC flexible clamp for currents up to 3000A, diameter 174mm, 4 pcs
C2033X	3-banana to Schuko plug cable
UNIVERSALKITG3	Set of 4 cables, 4 alligator clips and 3 test leads
KITTERRNE	Soft carrying bag containing 4 cables and 4 earth rods
RCDX10	Accessory for industrial RCDs up to 10A
PR400	Remote switch probe
PT400	Stylus
VA500	Rigid carrying case
YABAT0003000	Rechargeable NiMH battery 1.2V, AA, 6 pcs
A0060	Power Supplier/Battery Charger 100/230Vac - 15Vdc, 10W CAT IV
SP-0500	Set for slinging the instrument over one's shoulder
TOPVIEW2006	PC software and optical-to-USB connection cable C2006
	Quick user's guide
	User's manual on CD-ROM
	Calibration certificate ISO9000

Optional accessories

HTFLEX35	AC flexible clamp for currents up to 3000A, diameter 274mm
HT96U	Clamp transducer AC 1-100-1000A/1V, diameter 54mm
HT98U	Clamp transducer DC 1000A/1V, diameter 50mm
HP30C2	Clamp transducer AC 200-2000A/1V, diameter 70mm
HP30C3	Clamp transducer AC 200-2000A/1V, diameter 70mm
HP30D1	Clamp transducer DC 1000A/1V, diameter 83mm
HT4003	Clamp transducer 400A AC, diameter 30mm
HT4004	Clamp transducer 100A AC/DC, diameter 32mm
HT4005N	Clamp transducer AC 0÷5A, 0÷100A diameter 20mm
HT4005K	Clamp transducer 200A AC, diameter 40mm
HT903	3x1-5A/1V box for external TA connection
IMP57	High resolution impedance measurement adapter
T2100	Earth ground clamp transducer for Stakeless measurements
606-IECN	Magnetic adapter for connection to screw heads
1066-IECN	Black connector for extensions (4mm banana)
RCDX10	Accessory for industrial RCDs up to 10A
VA504	Rigid transport case for device and clamp T2100
BORSA2051	Rigid transport case for device
HT52/05	Transducer for temperature/humidity measurement
HT53/05	Transducer for illuminance measurement



You Tube

ORDER CODE **HV005036**

MACROTESTG3

ADVANCED MULTIFUNCTION DEVICE FOR VERIFICATION OF ELECTRIC SAFETY OF DOMESTIC AND INDUSTRIAL ELECTRIC SYSTEMS (IEC/EN61557-1)

- **All verifications of electric safety** provided for by standards **IEC/EN61557-1**
- **Advanced Loop** Verification of magnetothermal protections, fuses and cable sizes.
- **Earth resistance** by **voltammetric method** with 2 or 3 poles in TT, TN and IT systems, **non-trip earth resistance measurement** and earth resistance with stakeless testing method with **clamp meter T2100** (optional). **Ground resistivity**.
- **Measurement of electric parameters in single-phase** installations (V, I, W, VAR, VA, PF)
- **Test of RCDs** type A, AC, B up to 1A, earth leakage relays with test current up to 10A (with optional accessory RCDX10).
- Measurement of **insulation resistance**.
- Measurement of **continuity** of protection conductors.
- Verification of **phase sequence (SEQ)** and **leakage currents**.
- **Measurement of environmental parameters** through external probes.

MacrotestG3 is a revolutionary device.

Its TFT colour display with **touch-screen** allows using this device in a completely new manner. **MacrotestG3** makes available on its display **all possible variables** to obtain a **perfect measurement**; your task will only be to "touch" what you really want to measure: then simply leave the rest to Macrotest G3's micro-processor!

The device complies with **all requirements** as regards the safety of electric systems: **test of RCDs** type A, AC also up to 1000 mA and type B; **insulation, continuity, earth resistance tests** (this also with the aid of the optional clamp T2100).

With the appropriate programming guided by the touch-screen system, this device can test the **breaking capacity, tripping current, I2t** relevant to **magneto-thermal switches (MCB)** with curves B, C, D, K and fuses type gG and aM!

The device can be used with external probes for measuring environmental parameters such as air temperature/humidity, illuminance (Lux) further to measuring leakage currents, cosphi, power and harmonics, Loop/Line impedance and calculating the prospective short-circuit current with high resolution (0.1mOhm) in TN systems with use of optional accessory IMP57.

Cutting-edge management of measurement with indication, at the end of each safety test, of **compliance or non-compliance with requirements** with simple symbols **OK** or **NOT OK**.



Power measurement, using the HTAnalysis™ App on tablet.



Start/stop measuring with remote lead PR400.



Measurement of leakage current with optional clamp HT96U.



Earth resistance measurement with clamp T2100.



Selection of RCD type and tripping current.

Selection of test voltage and minimum limit value on MQ measurement.

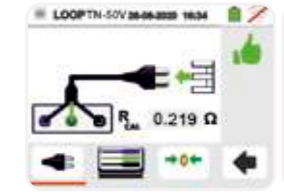

Zero-loop: compensation of the resistance of the test cables used for Loop impedance measurement.



Autosequence: automatic sequence of measurements of Overall earth resistance, RCD test and Insulation L-PE, N-PE.

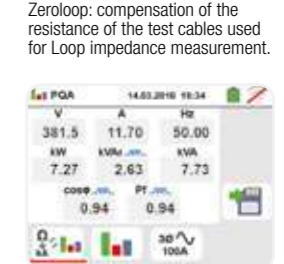

Power measurement.

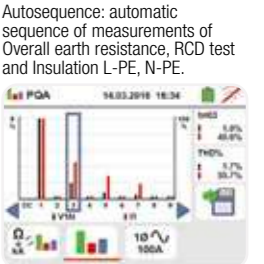

Power measurement: harmonics.

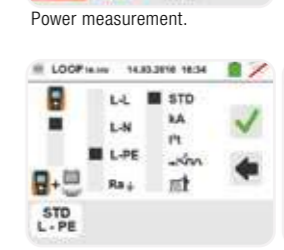

Advanced Loop.

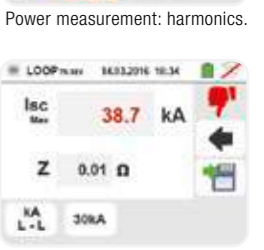

Advanced Loop: negative result of breaking capacity test.



Earth resistance: selection of measurement type.

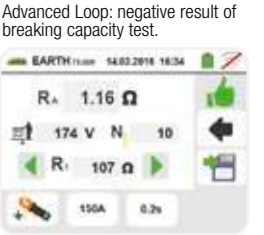

Earth resistance: result OK.

Functions

- AUTO test (overall earth resistance test, RCD tests, insulation tests) on the outlets to be tested
- Insulation with voltage 50, 100, 250, 500, 1000VDC
- Continuity of protective conductors with 200mA
- Earth resistance by voltammetric method
- Earth resistance with stakeless testing method
- Ground resistivity by 4-wire method
- Non-trip earth resistance with no RCD tripping
- Line/Loop impedance, Phase-Phase, Phase-Neutral, Phase-PE
- Line/Loop impedance, Phase-Phase, Phase-Neutral, Phase-PE with high resolution (0.1 mΩ with optional accessory IMP57)
- ZEROLOOP function for a compensation of the resistance of the test cables used for Loop measurement
- Prospective short-circuit current
- Contact voltage
- Tripping time of General, Selective and Delayed RCDs.
- Test current A, AC max 1A and type B max 300mA.
- Test on earth leakage relays up to 10A
- RCD tripping current (Ramp test)
- Measurement in AUTOMATIC sequence of Overall earth resistance, RCD test, Insulation (AUTOTEST)
- Phase sequence
- Measurement of percentage voltage drop on the lines
- Measurement with use of remote lead (with optional accessory PR400)
- Leakage current (with optional clamp HT96U)
- Measurement of electric parameters (V, I, W, VAR, VA, Wh, cosphi)
- Harmonic analysis V, I and THD%
- Help on line on the display
- Internal memory for measured data saving
- Optical/USB serial port for PC connection
- Integrated WiFi communication interface

Main features

Power supply:	6x1.2V rechargeable batteries type AA NiMH or 6x1.5 type AA alkaline
Battery life:	> 550 test (alkaline)
Display:	Resistive touch screen, colour LCD, resolution 320x240 pxl
Memory:	999 locations, 3 levels of markers
PC interface:	optical/USB and WiFi
Safety:	IEC/EN61010-1, double insulation
Operating humidity:	<80%RH
Operating temperature:	0 ÷ 40°C
Storage humidity:	<80%RH
Storage temperature:	-10 ÷ 60°C
Measurement category:	CAT III 240V, max 415V between inputs
Pollution level:	2
Reference standard:	IEC/EN61557-1-2-3-4-5-6-7
Size (LxWxH):	225 x 165 x 75 mm
Weight (batteries included):	1.2 kg

Included accessories

C2033X	Cable with 3-terminal Shuko plug
UNIVERSALKITG3	Set of 4 cables, 4 alligator clips, 3 leads
KITTERRNE	Bag with 4 cables + 4 metal probes
PR400	Remote lead for test activation
PT400	Touch-screen pen
VA507	Rigid transport case for device + accessories
YABAT0003000	1.2V NiMH AA rechargeable battery, 6 pieces
YABAT0004001	Battery charger for 6 AA/AAA batteries
TOPVIEW2006	Management software + optical/USB C2006 cable
ZEROLoop	Accessory for zeroing the cable in Loop measurement
	Quick user guide
	User manual on CD-ROM
	ISO9000 calibration certificate

Optional accessories

HT96U	AC clamp for leakage current, 1-100-1000A/1V, diameter 54mm
HT4005K	Clamp AC 200A/1V, diameter 40mm
IMP57	Accessory for measuring Loop impedance with high resolution
T2100	Clamp for measuring the resistance of earth rods
SP-0400	Set for slinging the instrument over one's shoulder
606-IECN	Adapter for leads with magnetic terminal
1066-IECN	Connector for cable extension banana 4mm
RCDX10	Accessory for industrial earth leakage relays up to 10A
BORSA2051	Rigid transport case for device
VA504	Rigid carrying case for device and clamp T2100
HT52/05	Probe for measuring temperature/humidity
HT53/05	Probe for illuminance measurement

MULTIFUNCTION INSTALLATION TESTERS



ORDER CODE HV005037 | HV005038

MACROTESTG1 MACROTESTG2

ADVANCED MULTIFUNCTION DEVICE FOR VERIFICATION OF ELECTRIC SAFETY OF DOMESTIC AND INDUSTRIAL ELECTRIC SYSTEMS (IEC/EN61557-1)

- ▶ **Earth resistance** by **voltammetric method** with 2 or 3 spots in TT, TN and IT systems, **overall earth resistance measurement** and with **clamp meter T2100** (optional).
- ▶ **Ground resistivity.**
- ▶ **Measurement of electric parameters in single-phase installations** (V, I, W, VAR, VA, PF)
- ▶ Measurement of **insulation resistance (Macrotest G2).**
- ▶ Measurement of **continuity** of protection conductors.

MacrotestG2 and MacrotestG1 fully take advantage of the **touch-screen** technology developed for MacrotestG3 and, hence, of all its settings, but their application range is for measuring **insulation resistance** and **earth resistance by voltammetric method**, also with **optional clamp T2100** and, finally, for **continuity measurement of protective conductors**. Cutting-edge management of measurement with indication, at the end of each safety test, of compliance or non-compliance with requirements with simple symbols **OK** or **NOT OK**.



Measurement of earth resistance with Clamp T2100.

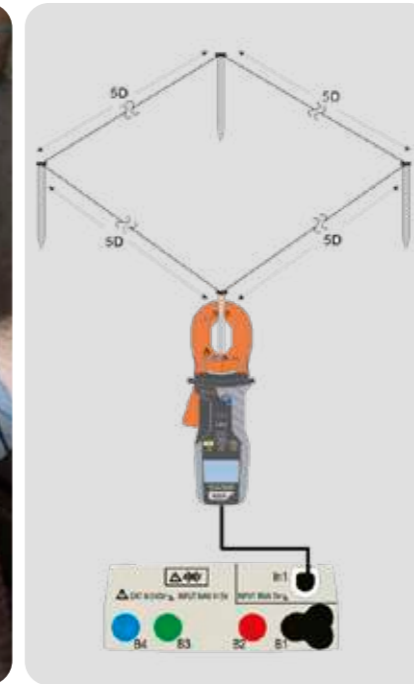

Example of measurement diagram with T2100.



Use on tablets through the HTAnalysis™ App.



Measurement of earth impedance by voltammetric method.



Measurement result negative.

Selection of test voltage and minimum limit value on measurement.

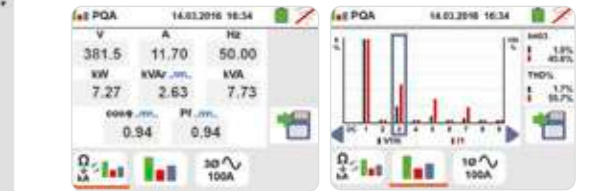

Power measurement.

Power measurement: harmonics.



Selection of earth measurement type.

Earth resistance measurement result OK.



Start/stop measuring with remote lead PR400.

Functions

- Insulation with voltage 50, 100, 250, 500, 1000VDC (**Macrotest G2**)
- Continuity of protective conductors with 200mA
- Earth resistance by voltammetric method
- Earth resistance with stakeless testing method
- Ground resistivity by 4-wire method
- Measurement with use of remote lead (with optional accessory PR400)
- Measurement of electric parameters (V, I, W, VAR, VA, Wh, cosphi)
- Harmonic analysis V, I and THD%
- Help on line on the display
- Internal memory for measured data saving
- Optical/USB serial port for PC connection
- Integrated WiFi communication interface

Main features

Power supply:	6x1.2V rechargeable batteries type AA NiMH or 6x1.5 type AA alkaline
Battery life:	> 550 test (alkaline)
Display:	Resistive touch screen, colour LCD, resolution 320x240 pxl 999 locations, 3 levels of markers
Memory:	999 locations, 3 levels of markers
PC interface:	optical/USB and WiFi
Safety:	IEC/EN61010-1, double insulation
Operating humidity:	<80%RH
Operating temperature:	0 ÷ 40°C
Storage humidity:	<80%RH
Storage temperature:	-10 ÷ 60°C
Measurement category:	CAT III 240V, max 415V between inputs
Pollution level:	2
Reference standard:	IEC/EN61557-1-2-4-5
Size (LxWxH):	225x165x75 mm
Weight (batteries included):	1.2 kg

Included accessories

UNIVERSALKITG3	Set of 4 cables, 4 alligator clips, 3 leads
KITERRNE	Bag with 4 cables + 4 metal probes
PT400	Touch-screen pen
VA507	Rigid transport case for device + accessories
YABAT0003000	1.2V NiMH AA rechargeable battery, 6 pieces
YABAT0004001	Battery charger for 6 AA/AAA batteries
TOPVIEW2006	Management software + optical/USB C2006 cable
	Quick user guide and User manual on CD-ROM
	ISO9000 calibration certificate

Optional accessories

T2100	Clamp for measuring the resistance of earth probes
SP-0400	Set for slinging the instrument over one's shoulder
606-IECN	Adapter for leads with magnetic terminal
1066-IECN	Connector for cable extension banana 4mm
PR400	Remote lead for test activation
HT4005K	Clamp AC 200A/1V, diameter 40mm
BORSA2051	Rigid transport case for device
VA504	Rigid transport case for device with accessories + clamp T2100



ORDER CODE HV000062

COMBIG2

ADVANCED MULTIFUNCTION DEVICE FOR VERIFICATION OF ELECTRIC SAFETY OF DOMESTIC AND INDUSTRIAL ELECTRIC SYSTEMS (IEC/EN61557-1)

- **All verifications of electric safety** provided for by standards IEC/EN61557-1.
- **Advanced Loop** Verification of magnetothermal protections, fuses and cable sizes.
- **Measurement of electric parameters in single-phase** installations (V, I, W, VAR, VA, PF)
- **Test of RCDs** type A, AC, B up to 1A, and earth leakage relays with test current up to 10A (with optional accessory RCDX10).
- Measurement of **insulation resistance**.
- Measurement of **continuity** of protection conductors.
- Verification of **phase sequence (SEQ)** and **leakage currents**.
- **Measurement of environmental parameters** through external probes.

COMBIG2 is used for checking the safety of domestic and industrial electric systems (IEC/EN61557-1).

Thanks to its building characteristics, the type of setting and the multiple applications as regards the documentation it is capable of producing, this device can satisfy even the most demanding technician and the most rigorous verifier.

Its TFT colour display with **touch-screen** allows using this device in a completely new manner. **COMBIG2 makes available on its display all possible variables to obtain a perfect measurement**; your task will only be to "touch" what you really want to measure: then, simply leave the rest to COMBIG2's micro-processor!

The device complies with **all requirements as regards the safety of electric systems: test of RCDs type A, AC also up to 1000 mA and type B; insulation, continuity, earth resistance tests** directly on the power outlet without causing the RCDs' tripping.

With the appropriate programming guided by the touch-screen system, this device can test the **breaking capacity, tripping current, I2t relevant to magneto-thermal switches (MCB) with curves B, C, D, K and fuses type gG and aM!**

Combined with **optional clamp HT96U** it is capable to carry out and record **measurements of leakage current, power, cosphi, harmonics, THD% and frequency**. This device has been devised for use together with optional accessories which widen its operating fields: e.g. **HT53/05** for measuring lux, **HT52/05** for measuring temperature and humidity and **RCDX10** for testing earth leakage relays **up to 10A**.

Cutting-edge management of measurement with indication, at the end of each safety test, of compliance or non-compliance with requirements with simple symbols **OK** or **NOT OK**.

Finally, thanks to the brand new **HTAnalysis App, free to download for iOS and Android systems**, COMBIG2 is capable of transferring measured and recorded data onto tablets and smartphones, thus giving the operator the possibility to customize and share through **HtCloud** the result of their tests.



Selection of RCD type and tripping current.



Selection of test voltage and minimum limit value on measurement.



Zero-loop: compensation of the resistance of the test cables used for Loop impedance measurement.



Autosequence: automatic sequence of measurements of Overall earth resistance, RCD test and Insulation L-PE, N-PE.



Measurement result negative.



Result of ramp test on RCD.



Selection of measurement type of phase sequence.



Measurement of leakage current with optional clamp HT96U.



General screen. Advanced Loop.



Negative result of breaking capacity test.



Power measurement, using the HTAnalysis™ App on tablet.



Measurement of leakage current with optional clamp HT96U.

Functions

- AUTO test (overall earth resistance test, RCD tests, insulation tests) on the outlets to be tested.
- Insulation with voltage 50, 100, 250, 500, 1000VDC
- Continuity of protective conductors with 200mA
- Non-trip earth resistance
- Line/Loop impedance, Phase-Phase, Phase-Neutral, Phase-PE
- Line/Loop impedance, Phase-Phase, Phase-Neutral, Phase-PE with high resolution (0.1 mΩ)
- ZEROLOOP function for a compensation of the resistance of the test cables used for Loop measurement.
- Prospective short-circuit current
- Contact voltage
- Tripping time of General, Selective and Delayed RCDs.
- Test current A, AC max 1A and type B max 300mA.
- Test on RCDs with separate clamp jaw up to 10A
- RCD tripping current (Ramp test)
- Measurement in AUTOMATIC sequence of Overall earth resistance, RCD test, Insulation (AUTOTEST)
- Phase sequence
- Measurement of percentage voltage drop on the lines
- Measurement with use of remote lead (with optional accessory PR400)
- Leakage current (with optional clamp HT96U)
- Measurement of electric parameters (V, I, W, VAR, VA, Wh, cosphi)
- Harmonic analysis V, I and THD%
- Help on line on the display
- Internal memory for measured data saving
- Optical/USB serial port for PC connection
- Integrated WiFi communication interface

Main features

Power supply:	6x1.2V rechargeable batteries type AA NiMH or 6x1.5 type AA alkaline
Battery life:	> 550 test (alkaline)
Display:	Resistive touch screen, colour LCD, resolution 320x240 pxl, 999 locations, 3 levels of markers
Memory:	999 locations, 3 levels of markers
PC interface:	Optical/USB and WiFi
Safety:	IEC/EN61010-1, double insulation
Operating humidity:	<80%RH
Operating temperature:	0 ÷ 40°C
Storage humidity:	<80%RH
Storage temperature:	-10 ÷ 60°C
Measurement category:	CAT III 240V, max 415V between inputs
Pollution level:	2
Reference standard:	IEC/EN61557-1-2-3-4-5-6-7
Size (LxWxH):	225x165x75mm
Weight (batteries included):	1.2 kg

Included accessories

C2033X	Cable with 3-terminal Schuko plug
UNIVERSALKITCOMBI	Set of 3 cables, 3 alligator clips, 3 leads
PT400	Touch-screen pen
VA507	Rigid transport case for device + accessories
TOPVIEW2006	Management software + optical/USB C2006 cable
ZEROLoop	Accessory for zeroing the cable in Loop measurement
	Quick user guide
	User manual on CD-ROM
	ISO9000 calibration certificate

Optional accessories

HT96U	AC clamp for leakage current, 1-100-1000A/1V, diameter 54mm
IMP57	Accessory for measuring Loop impedance with high resolution
SP-0400	Set for slinging the instrument over one's shoulder
606-IECN	Adapter for leads with magnetic terminal
1066-IECN	Connector for cable extension banana 4mm
RCDX10	Accessory for industrial RCDs up to 10A
YABAT0003000	1.2V NiMH AA rechargeable battery, 6 pieces
YABAT0004001	Battery charger for 6 AA/AAA batteries
PR400	Remote lead for test activation
VA500	Rigid transport case for device and accessories
HT52/05	Probe for measuring temperature/humidity
HT53/05	Probe for illuminance measurement

YouTube



ORDER CODE HV000420 | HV004210

COMBI420|421

MULTIFUNCTION DEVICES FOR TESTS ON DOMESTIC AND INDUSTRIAL SYSTEMS WITH MAINS REAL TIME ANALYSIS

COMBI421 and COMBI420 carries out tests of electric systems and therefore measurements of **overall earth resistance**, tests on RCDs type A and AC up to a rated current of 1A (up to 650mA for COMBI420), Insulation, Continuity and short-circuit currents, it also allows measuring and saving environmental parameters (illuminance, temperature), leakage current and the electric quantities active power, harmonics, power factor on single-phase systems and, last but not least, it offers the possibility of checking phase sequence only using one lead. The **internal memory** allows **saving** the measurements carried out in order to subsequently **transfer them onto the PC** through the serial connection.

The instruments has been provided with the innovative **AUTO function**: by selecting this function and only setting the value of RCD current, the models, connected to a power outlet, carries out tests of overall earth resistance, on RCDs and insulation tests in a sequence. At the end of the test, the device shows all results with the indication of compliance or non-compliance with the standards with simple symbols **OK** or **NOT OK**.



ORDER CODE HV000419

COMBI419

MULTIFUNCTION DEVICE FOR TESTS ON DOMESTIC AND INDUSTRIAL SYSTEMS

COMBI419 carries out tests of electric systems in compliance with IEC/EN61557-1 and therefore measurements of **non-trip earth resistance**, tests on RCDs type A and AC up to a rated current of 1A, Insulation, Continuity and short-circuit currents, it also allows measuring and saving leakage current and offers the possibility of checking phase sequence only using one lead.

The **internal memory** allows **saving** the measurements carried out in order to subsequently **transfer them onto the PC** through the USB connection.

In order to make it versatile and fully functional for any kind of end user, the device has been provided with the innovative **AUTO** function: by selecting this function and only setting the value of RCD current, COMBI 419, connected to a power outlet, carries out tests of non-trip earth resistance, on RCDs and insulation tests in a sequence. At the end of the test, the device shows all results with the indication of compliance or non-compliance with the standards with simple symbols **OK** or **NOT OK**.

Functions and characteristics

- Continuity of protective conductors with 200mA
- Insulation with 50, 100, 250, 500, 1000VDC
- Tripping time of type A, AC general and Selective RCDs up to 1A (up to 650mA for COMBI420)
- Tripping current of type A, AC general up to 650mA
- Loop/Line impedance P-N, P-P, P-PE also with high resolution (0.1mΩ) with optional accessory IMP57
- Non-trip earth resistance
- Contact voltage
- Phase sequence
- AUTO test (non-trip earth resistance, RCD and insulation test) on the outlets to be tested
- Power and cosphi measurements in single-phase systems
- Voltage and current harmonics up to the 49th with THD%
- Measurement of environmental parameters (temperature, humidity, illuminance) with optional probes
- Measurement of leakage currents (with optional clamp HT96U)
- Activation of measurements with optional remote lead PR400
- Context help on the display
- Storage of results
- Optical/USB interface for PC connection
- **Safety: IEC/EN61010-1, IEC/EN61557-1-2-3-4-6-7**
- **Measurement category: CATIII 240V (to earth), max 415V between inputs**
- **Power supply: 6x1.5V batteries type AA, LR6, AM3, MN 1500**
- **Size (LxWxH): 235x165x75mm**
- **Weight (batteries included): 1.2 kg**

Included accessories

UNIVERSALKITCOMBI	Set of 3 cables + 3 alligator clips + 3 leads
C2033X	3-terminal cable with Schuko plug
BORSA75	Soft carrying bag
	User manual on CD-ROM and Quick guide for use
	ISO9000 calibration certificate

Optional accessories

TOPVIEW2006	Windows software for PC + optical/USB cable
IMP57	Accessory for measuring Loop impedance with high resolution (0,1mΩ)
HT4005K	Standard AC 200A/1V clamp, diameter 40mm
HT4005N	Standard AC 5-100A/1V clamp, diameter 20mm
HT96U	AC clamp for leakage current, 1-100-1000A/1V, diameter 54mm
SP-0400	Set for slinging the instrument over one's shoulder
PR400	Remote lead for test activation
VA507	Rigid transport case for device and accessories
HT52/05	Probe for measuring temperature/humidity
HT53/05	Probe for illuminance measurement

Functions and characteristics

- Continuity of protective conductors with 200mA
- Insulation with 50, 100, 250, 500, 1000VDC
- Tripping time of type A, AC general and Selective RCDs up to 1A
- Tripping current of type A, AC general up to 650mA
- Loop/Line impedance P-N, P-P, P-PE also with high resolution (0.1mΩ) with optional accessory IMP57
- Non-trip earth resistance
- Contact voltage
- Phase sequence
- AUTO test (non-trip earth resistance, RCD and insulation test) on the outlets to be tested
- Measurement of leakage currents (with optional clamp HT96U)
- Activation of measurements with optional remote lead PR400
- Context help on the display
- Storage of results
- Optical/USB interface for PC connection
- **Safety: IEC/EN61010-1, IEC/EN61557-1-2-3-4-6-7**
- **Measurement category: CATIII 240V (to earth), max 415V between inputs**
- **Power supply: 6x1.5V batteries type AA, LR6, AM3, MN 1500**
- **Size (LxWxH): 235x165x75mm**
- **Weight (batteries included): 1.2 kg**

Accessories provided

UNIVERSALKITCOMBI	Set of 3 cables + 3 alligator clips + 3 leads
C2033X	3-terminal cable with SHUKO plug
BORSA75	Soft carrying bag
	User manual on CD-ROM and Quick guide for use
	ISO9000 calibration certificate

Optional accessories

TOPVIEW2006	Windows software for PC + optical/USB cable
IMP57	Accessory for measuring Loop impedance with high resolution
HT4005K	Standard AC 200A/1V clamp, diameter 54mm
HT4005N	Standard AC 5-100A/1V clamp, diameter 20mm
HT96U	AC clamp for leakage current, 1-100-1000A/1V, diameter 54mm
SP-0400	Set for slinging the instrument over one's shoulder
PR400	Remote lead for test activation
VA500	Rigid transport case for device and accessories



→ **TRMS**

YouTube

ORDER CODE HV000075 | HV00075L

M75|M74

DEVICES FOR SAFETY TESTS WITH TRMS MULTIMETER FUNCTIONS AND TEST OF CABLE MAPPING (ONLY M75) ON LAN RJ-45 NETWORKS

M75 is the mobile device par excellence! HT suggests operators who mainly work on domestic installations to **ALWAYS** have M75 at hand. Here's the reason why: it is very easy to use, very small in size and it **fully automatically** carries out all necessary tests to establish COMPLIANCE (and hence ensure SAFETY) of a domestic electric system.

ALWAYS using it **before starting** working on an already existing system the operator does not know well and **ALWAYS** using it **at the end of the job** will guarantee the necessary safety to both operators and users of the electric systems!

Thanks to its **small size**, this device offers many operating opportunities. M75 is used for testing the safety of electric systems, so for **measuring overall earth resistance, testing RCDs type A and AC, insulation and continuity**.

In order to make it versatile and fully functional for any kind of end user, the device has been provided with the innovative **AUTO** function: by selecting this function and only setting the value of RCD current, M75, connected to a power outlet, carries out **tests of overall earth resistance, RCD tests and insulation tests in a sequence**. At the end of the test, the device shows all results with the indication of compliance or non-compliance with the standards with simple symbols **OK** or **NOT OK**.

This innovative product also offers the following functions: **TRMS** multimeter for **AC/DC voltage, AC/DC current** (with external clamp), **Resistance measurement, Test on LAN network cables, Test of phase sequence** with a single lead.

⚙️ Functions and characteristics

- Continuity of protective conductors with 200mA
- Insulation with 250,500VDC
- Tripping time on General RCDs type AC (up to 300mA) and type A (30mA)
- Tripping current on General RCDs type AC and A (30mA)
- Non-trip earth resistance
- AUTO function (non-trip earth resistance test, RCD tests, insulation tests)
- Phase sequence with 1 and 2 terminals
- Full test on cable mapping of LAN networks with RJ45 (**only M75**)
- DC/AC TRMS voltage
- DC/AC TRMS current
- Resistance and Continuity test
- Data HOLD, MAX/MIN/AVG
- Measurement of voltage and current PEAK
- Measurement of leakage currents (with optional clamp HT96U)
- **Safety: IEC/EN61010-1**
- **Measurement category: CATIII 550V**
- **Power supply with AA batteries 4x1.5V**
- **Size (LxWxH): 240x100x45 mm**
- **Weight (batteries included): approx. 450 g**

🛒 Included accessories

KIT0075	Set of 2 cables with leads + 2 alligator clips
C2075	2-terminal cable with Schuko plug
HT4003	Standard 400A/1V clamp (only M75)
CH1	Remote unit LAN #1 (only M75)
CH2	Remote unit LAN #2 (only M75)
YAAMS0000000	(3x) patch LAN RJ45 cable (only M75)
BORSA75	Soft carrying bag
	User manual on CD-ROM, calibration certificate ISO9000 and Quick user guide

🎁 Optional accessories

HT96U	Standard 1-100-1000A/1V clamp, diameter 54 mm
HT4005K	Standard 5-100A AC/IV clamp
HT4004N	Standard 10-100A DC/IV clamp
NOCANBA	Adapter for connecting HT96U, HT4004, HT4005N
REM 3,4,5,6,7,8	Single remote LAN unit, choose between no. 3, 4, 5, 6, 7, 8. (only M75)
REM38	Kit of 6 remote units (no. 3, 4, 5, 6, 7, 8) (only M75)



ORDER CODE HV000003

FULLTEST3

MULTIFUNCTION DEVICE FOR SAFETY TESTS ON SWITCHBOARDS AND MACHINES ACCORDING TO IEC/EN60204-1:2006 AND IEC/EN61439-1

- **Verification of dielectric strength** with test voltage up to 5100V in compliance with the prescriptions of new standard IEC/EN61439-1
- **Verification of protection against indirect contact** in compliance with the prescriptions of standard IEC/EN 60204-1:2006
- **Continuity of protective conductors** (test current 200mA ÷ 25A)
- **Verification of RCD tripping** (RCD AC, A, B) up to 1A
- **Measurement of Non-trip earth resistance**
- **Verification of coordination of magneto-thermal protections** (MCB curves B, C, D, K) and fuses (gG, aM)
- **Insulation resistance** with test voltage up to 1000V
- **Verification of residual voltage** on capacitive elements
- **Measurement of leakage current** through the outlet and through optional clamp (HT96U)
- **Functional test** through outlet (power, current)
- **Phase sequence**
- **Tests in automatic sequence:** possibility to program a sequence of tests with automatic start up to a maximum of 8.



HT offers a cutting-edge device to carry out all measurements required by the new laws as regards tests to be performed on electric switchboards and machines IEC/EN60204-1:2006 and IEC/EN61439-1.

Further to measurements of **protective conductors' continuity, insulation and dielectric strength**, FULLTEST3 is capable of carrying out tests on RCDs type A, AC and B, General, Selective and Delayed, measurements of Line/Loop impedance also with high resolution 0.1mΩ (with optional accessory IMP57), measurement of non-trip earth resistance and leakage current with clamp transducer. It can also carry out test on breaking capacity, protection tripping, I2t tests relevant to magneto-thermal circuit breakers in curve B, C, D, K and fuses type gG and aM. The device is also provided with a "touch-screen" colour display and 3 USB ports for connection to PC, USB pen drive, USB printers and possible bar code readers.



FULLTEST at work



Functions

- Continuity of protective conductors with 200mA
- Continuity of protective conductors with I>10A, V<12V
- Continuity of protective conductors with I>25A, V<12V
- Insulation with test voltages 100, 250, 500, 1000VDC
- Dielectric withstand with voltage programmable from 250V to 5100VAC
- Discharge time/residual voltage on plugs and internal circuits
- Absorbed/leaked current and power at plug of machines
- Tripping time/current of type A, AC, B General and Selective RCDs up to 1000mA
- Contact voltage
- Line/Loop impedance and Ipsc calculation
- Line/Loop impedance with high resolution (with optional accessory IMP57)
- Non-trip earth resistance
- Leakage current (with optional accessory HT96U)
- Phase sequence
- Timer and limit thresholds selectable through programmable ramps

Main features

Power supply:	207V ÷ 253V / 50-60Hz
Protection:	with fuses, at input
Display:	LCD colour "touch-screen" display
Memory:	internal, 999 locations
PC interface:	USB (PC, pen drive, printers, etc.) and Bluetooth™
Mechanical protection:	IP40
Pollution level:	2
Safety:	IEC/EN61010-1
Considered standards:	IEC/EN61557-1-2-3-4-13-14 IEC/EN60204-1:2006 IEC/EN61439-1 IEC/EN60335-1 EN50106
Measurement category:	CAT III 300V (safety test) CAT III 300V (functional test)
Size (LxWxH):	400x300x170mm
Weight:	15 kg

Included accessories

	Integrated power supply cable
2317-IECIV-200-R	Test cable 2.5mm ² , 2m, red, 2 pieces
2310-IECIV-200-B	Test cable 0.75mm ² , 2m, blue
2310-IECIV-200-V	Test cable 0.75mm ² , 2m, green
2310-IECIV-200-N	Test cable 0.75mm ² , 2m, black, 2 pieces
C2033X	Cable with 3-terminal Shuko plug
FT3HVPRB1	1 cable banana-alligator clip + 1 cable banana-lead 2m HV
404-IECN	Measuring lead CAT III, 3 pieces
5004-IECN	Alligator clip, 4 pieces
TOPVIEW2007	Windows software + USB cable
FT3BRSN	Soft carrying bag for accessories.
	ISO9000 calibration certificate
	User Manual
	Quick user guide
	User manual on CD-ROM

Optional accessories

IMP57	Accessory for measuring Loop impedance with high resolution
HT96U	Clamp for measuring leakage currents
FT3HVTIP	Cable banana-lead, black HV
FT3KBDEN	USB keyboard
FT3R-GLP*	Red/green control lamp for ongoing test with 7m cable
FT3RMTCT	Remote start/stop/save button with cable length 7 m.
FT3SFTSW	Open door detection device for verification room
FT3MPT2	Thermal printer with 32 columns
FT3BARCR	Bar code reader with USB port
FT3BLACKBOX	Device for functional verification of FULLTEST3
C2009AD	Cable with adapter for connection to IMP57
FT3REDLP**	Red control lamp for ongoing test with 7m cable

(*) For devices with HW version 70 or higher and N/S equal or higher than 16101107. (**) For devices with HW version lower than 70.



ELECTRIC VEHICLE SUPPLY EQUIPMENT CHECK



VERIFICATION OF ELECTRIC VEHICLE CHARGING STATIONS

ORDER CODE HV5036EV

MACROEVTEST

INSTRUMENT FOR THE VERIFICATION OF ELECTRIC VEHICLE CHARGING STATIONS AND ELECTRIC SAFETY

EV-TEST100

ADAPTER FOR THE VERIFICATION OF ELECTRIC VEHICLE CHARGING STATIONS

YouTube

WiFi

TOUCH SCREEN



NEW

MACROEVTEST, the instrument for verification and checks on recharging stations for electric cars (EVSE) in compliance with standards IEC/EN 61851-1 and IEC/EN60364-7-722, and for safety tests in domestic and industrial environments. **MACROEVTEST** is connected through the provided C100EV cable to **EV-TEST100**, which is connected, through an in-built cable provided with type2 plug, to a charging station. **EV-TEST100** can simulate the presence of a car being recharged and, at the same time, dialogues with **MACROEVTEST** thanks to the new display with touch screen system. To correctly perform all tests, all you need to do is following the GUIDED PROCEDURE created by HT. Before each test, **MACROEVTEST** indicates how the cables must precisely be connected and, at the end of measurement, further to the detected values, it provides evaluations of the tests' outcomes, if compatible or not for the recharging station's safety, indicated by a green or red thumb symbol.



Guided sequence of tests.

- Continuity of the protective conductor with current up to 200mA
- Verification of insulation to earth of power conductors
- Verification of charge status of the electric vehicle and simulation of PE and CP fault
- Verification of the cable's mechanical interlock during the recharging phase
- Verification of overall earth resistance of the system the EVSE is connected to
- Verification of the tripping time and current of the RCD type A and type B of the EVSE system

Functions of EV-TEST100

- Simulation of the type of cable connected: Not connected, 13A, 20A, 32A, 63A
- Control pilot (CP): A, B, C, D
- Simulation of the vehicle status:

Status Description

- A : Vehicle not connected
- B : Vehicle not connected, not ready for recharge
- C : Vehicle connected, ready for recharge, ventilation not requested
- D : Vehicle connected, ready for recharge, ventilation requested

- Simulation of interrupted protective conductor (fault PE)
- Simulation of short-circuited diode (fault E)
- Simulation of vehicle with Control Pilot (CP status)
- Simulation of the cable's range with Proximity Pilot (PP status)
- Simulation of the earthing's fault (fault PE)
- Simulation of error on Control pilot signal (fault E)
- Indication of phase presence via three LEDs
- Connection terminals for the connection to an external load, for the verification of the correct operation of the recharging station's energy counter
- Verification of conformity of recharging stations to standards IEC 61851-1 and IEC 60364-7-722

Functions of MACROEVTEST

- AUTO test (overall earth resistance test, RCD tests, insulation tests) on the outlets to be tested
- Insulation with test voltage 50, 100, 250, 500, 1000 VDC
- Continuity of protective conductors with 200mA
- Earth resistance by voltammetric method
- Resistance of the earth rods with clamp
- Ground resistivity by 4-wire method
- Overall earth resistance with no residual current protection tripping
- Line/Loop, Phase-Phase, Phase-Neutral, Phase-PE impedance
- Line/Loop, Phase-Phase, Phase-Neutral, Phase-PE impedance with high resolution (0.1 mΩ) with optional accessory IMP57
- Assumed short-circuit current
- Tripping time of General, Selective and Delayed RCDs.
- Test current type A, AC max 1A and type B max 300mA
- Test on RCDs with separate clamp jaw up to 10A
- RCD tripping current (Ramp test)
- Phase sequence
- Measurement of percentage voltage drop on the lines
- Test with use of remote switch probe (with optional accessory PR400)
- Leakage current (with optional clamp HT96U)
- Measurement of electric parameters (V, I, W, VAR, VA, Wh, cosphi)
- Harmonic analysis V, I and THD%
- Help on line on the display
- Internal memory for measured data saving
- Optical/USB serial port for PC connection
- Built-in WiFi communication interface

Characteristics of MACROEVTEST

Power supply:	6x1.2V rechargeable batteries type AA NIMH or 6x1.5 type AA alkaline
Battery life:	> 550 test (alkaline)
Display:	Resistive touch screen, colour LCD, resolution 320x240 pxi
Memory:	999 locations, 3 levels of markers
PC interface:	optical/USB and WIFI
Safety:	IEC/EN61010-1, double insulation
Operating humidity:	<80%RH
Operating temperature:	0°C ÷ 40°C
Storage humidity:	<80%RH
Storage temperature:	-10°C ÷ 60°C
Measurement category:	CAT IV 300V, max 415V between inputs
Pollution level:	2
Standards:	IEC/EN61557-1-2-3-4-5-6-7 IEC/EN61010-1
Size (LxWxH):	225 x 165 x 75 mm
Weight (batteries included):	1.2 kg

Characteristics of EV-TEST100

Voltage:	L1-L2-L3-N-PE: Max 415V 50/60Hz, CAT III 300V
External load:	L-N-PE: 240V 50/60Hz, CAT III 300V, max 10A~
CP signal:	Communication protocol PWM 12V
Input voltage:	Max 415V~ phase-phase, CAT III 300V, 50Hz/60Hz ±5%,
Recharging station:	Cases A, B, C - Recharging mode 2 and 3 - Connector IEC 62196-2 Type 2 (7 three-phase poles)
External load output protection:	Fuse FF 10A/250V, 5x20mm
CE directive:	Low voltage directive LVD 2014/35/EU and directive EMC 2014/30/EU
Safety:	IEC EN 61010-1
Operating temperature interval:	0°C ÷ 40°C
Operating relative humidity interval:	<80%RH
Pollution level:	2
Measurement category:	CAT III 300V
Double insulation	
Maximum operating height:	2000m

Provided accessories

EV-TEST100	Adapter for verification of EVSE stations
C2033X	Cable with 3-terminal Shuko plug
UNIVERSALKITG3	Set of 4 cables, 4 alligator clips, 3 leads
KITERRNE	Bag with 4 cables + 4 metal probes
PR400	Remote lead for test activation
PT400	Touch-screen pen
RCDX10	Accessory for RCD tests with separate clamp jaws
YABAT0003000	1.2V NIMH AA rechargeable battery, 6 pieces
YABAT0004001	Battery charger for 6 batteries type AA/AAA
TOPVIEW2006	Management software + optical/USB C2006 cable
ZEROLOOP	Accessory for zeroing the cable in Loop measurement
C100EV	Connection cable to the verification instrument
VA507	Rigid transport bag
SP-5100	Set of straps for slinging the instrument over one's shoulder
	Quick user guide, User manual
	ISO calibration report

NEW

ORDER CODE HA0EV100

EV-TEST100

ADAPTER FOR THE VERIFICATION ON THE RECHARGING STATION FOR ELECTRIC VEHICLES

- › Suitable for recharging stations with recharging mode 2 and 3
- › Simulation of vehicle with Control Pilot (CP status)
- › Simulation of the cable's range with Proximity Pilot (PP status)
- › Simulation of the earthing's fault (fault PE)
- › Simulation of error on Control pilot signal (Fault E)
- › Indication of phase presence via three LEDs
- › Connection terminals for connection to external load
- › Measuring leads L1-L2-L3-N-PE to connect HT instruments
- › Verification of conformity of recharging stations to standards IEC 61851-1 and IEC 60364-7-722.

Compatible instruments:

- MACROEVTEST



Functions

- Simulation of the type of cable connected: Not connected, 13A, 20A, 32A, 63A
- Control pilot (CP): A, B, C, D
- Simulation of the vehicle status:

Status Description

- A : Vehicle not connected
- B : Vehicle not connected, not ready for recharge
- C : Vehicle connected, ready for recharge, ventilation not requested
- D : Vehicle connected, ready for recharge, ventilation requested

- Simulation of interrupted protective conductor (fault PE)
- Simulation of short-circuited diode (fault E)
- Simulation of vehicle with Control Pilot (CP status)
- Simulation of the cable's range with Proximity Pilot (PP status)
- Simulation of the earthing's fault (fault PE)
- Simulation of error on Control pilot signal (fault E)
- Indication of phase presence via three LEDs
- Connection terminals for the connection to an external load, for the verification of the correct operation of the recharging station's energy counter
- Verification of conformity of recharging stations to standards IEC 61851-1 and IEC 60364-7-722

Main features

- Voltage:** L1-L2-L3-N-PE: Max 415V 50/60Hz, CAT III 300V
- External load:** L-N-PE: 240V 50/60Hz, CAT III 300V, max 10A~
- CP signal:** Communication protocol PWM 12V
- Input voltage:** Max 415V~ phase-phase, CAT III 300V, (50Hz, 60Hz) +/-5%
- Recharging station:** Cases A, B, C-Charging modes 2 and 3- Connector IEC 62196-2 Type 2 (7 three-phase poles)
- External load output protection:** Fuse FF 10A/250V, 5x20mm
- CE directive:** Low voltage directive LVD 2014/35/EU
- Safety:** IEC EN 61010-2014/35/EU (LVD) and EMC 2014/30/EU
- Operating temperature interval:** 0°C ÷ 40°C
- Operating relative humidity interval:** <80%RH
- Pollution level:** 2
- Measurement category:** CAT III 300V
- Double insulation**
- Maximum operating height:** 2000m

Provided accessories

VA508	Rigid transport bag
C100EV	Connection cable to the verification instrument
User Manual	



EARTH RESISTANCE AND STEP/CONTACT VOLTAGE TESTERS



EARTH RESISTANCE AND STEP/CONTACT VOLTAGE MEASURING DEVICES



MAIN MEASUREMENTS	EARTH RESISTANCE			STEP/CONTACT VOLTAGE
	GEO416	M71	T2000 - T2100	HT2055
TRMS	•	•	•	•
Measuring range	50KΩ	50KΩ	1.2KΩ	200Ω
Earth resistance by 2 and 3-wire method	•	•	-	•
Ground resistivity by 4-wire method	•	-	-	•
Compensation of disturbance voltages	•	•	-	•
Compensation of test cables	•	•	-	•
Direct measurement on earth probes without any cable interruption	-	-	•	-
Measurement of leakage current on earth systems	-	-	• Only for T2000	-
Measurement of step/contact voltage	-	-	-	•
ADDITIONAL CHARACTERISTICS				
Measurement category	CAT III 240V	CAT III 240V	CAT IV 300V CAT III 600V	CAT IV 50V
Detection of disturbance currents on measurement	•	•	-	•
LCD display	•	•	•	•
Backlight	•	-	•	•
AutoPowerOFF	•	•	•	•
Help on line on the display	•	-	-	•
Internal memory	•	-	•	•
Optical/USB serial port for PC connection	•	-	-	• RS-232/USB
USB port for device data download	-	-	• Only for T2100*	-
Size (LxWxH) (mm)	225x165x75	240x100x45	293x105x54	230x115x103
Weight in kg (batteries included)	1,0	0,6	1,1	30,8
Reference standard for safety	IEC/EN61010-1	IEC/EN61010-1	IEC/EN61010-1 IEC/EN61557-5	IEC/EN61010-1
Order code	HV000416	HV000071	HP002000 (T2000) HP002100 (T2100)	HN002055

* Compatible with Macrotest G1, G2 and G3.

EARTH RESISTANCE AND STEP/CONTACT VOLTAGE MEASURING DEVICES



ORDER CODE **HV000416**

GEO416

DEVICE FOR MEASURING EARTH RESISTANCE AND GROUND RESISTIVITY

GEO416 has been developed to measure **earth resistance with 2 wires, 3 wires and 4 wires** by **voltammetric method** and ground resistivity. These values are extremely important while designing earth systems. The 2-wire method, by taking advantage of appropriate external masses as a reference (metal surfaces, tubes, neutral conductor, etc.), is particularly useful in domestic environments where, because of logistic problems, it is not possible to use the 3-wire method.

The device allows carrying out **measurements with a wide measuring range (up to 50kOhm)** with an efficient internal compensation of the disturbance effects found on the installations. GEO416 is provided with an **internal memory for saving measurements** and with an **optical/USB interface for transferring** measured data onto the PC.



ORDER CODE **HV000071**

M71

DEVICE FOR MEASURING EARTH RESISTANCE

M71 has been developed to measure **earth resistance with 2 wires and 3 wires** by **voltammetric method** in compliance with standard IEC/EN61557-1.

This device allows carrying out measurements with a **wide measuring range (50kΩ)** and an efficient internal automatic compensation of the disturbance effects found on the installations, and it is provided with an **ergonomic design** with electronic function selector for **quickly** carrying out the tests.

The 2-wire method allows carrying out earth measurement by taking advantage of appropriate external masses as a reference (metal surfaces, tubes, neutral conductor, etc.), which is particularly useful in domestic environments where, because of logistic problems, it is not possible to use the 3-wire method.



Functions and characteristics

- Earth measurement with 2 and 3 terminals
- Ground resistivity by 4-wire method
- Measuring range: 0.01Ω - 50kΩ
- Compensation of disturbance voltages
- Compensation of test cables
- Context help on the display
- Storage of results
- Interface: optical/USB for PC connection
- **Safety: IEC/EN61010-1**
- **Measurement category: CAT III 265V**
- **Power supply with batteries type AA: 4x1.5V**
- **Size (LxWxH): 222x162x57mm**
- **Weight (batteries included): 1 kg**

Included accessories

KITTERRNE	Set of 4 cables + 4 metal probes
COCA4-UK	Set of 4 alligator clips
BORSA2000	Soft carrying bag
	User Manual
	ISO9000 calibration certificate

Optional accessories

TOPVIEW2006	Windows software for PC + optical/USB cable
1066-IECN	Connector for cable extension 4mm
SP-0400	Set of straps for slinging the instrument over one's shoulder
VA500	Rigid transport case for device and accessories
YABAT0003000	1.2V NIMH AA rechargeable battery, 6 pieces
YABAT0004001	Battery charger for 6 AA/AAA batteries

Functions

- Earth measurement with 2 terminals
- Earth measurement with 3 terminals
- Measuring range: 0.01Ω -50kΩ
- Compensation of disturbance voltages
- Compensation of test cables

Main features

Power supply:	batteries type AA 4x1.5V
Display:	LCD display
Pollution level:	2
Safety:	IEC/EN61010-1
Measurement category:	CAT III 240V
Size (LxWxH):	240x100x45mm
Weight (batteries included):	630g

Included accessories

KIT0071	Set of 3 cables + 3 alligator clips + 2 metal probes
SP-6085	Soft carrying bag
	User manual on CD-ROM
	Quick user guide
	ISO9000 calibration certificate

Optional accessories

1066-IECN	Connector for cable extension 4mm
-----------	-----------------------------------

EARTH RESISTANCE AND STEP/CONTACT VOLTAGE MEASURING DEVICES



CAT III 600V



ORDER CODE HP002000 | HP002100

T2000 | T2100

CLAMP METERS FOR MEASURING EARTH RESISTANCE WITH STAKELESS TESTING METHOD AND LEAKAGE CURRENT UP TO 20A AC

T2000 e T2100 are professional voltammetric clamps specially developed to evaluate resistance of earth rods with no need to disconnect any part of the system. The inner part of the device is made of 2 jaws, one for current reading and the other for voltage generation. The voltage jaws generate a potential (E) on the loop during resistance (R) measurement. A current (I) is consequently generated on the loop and is measured by the current jaws. Based on the value of parameters E and I, the instrument displays the resistance R value calculated as their ratio. The value measured by the device can be used in case the single rods do not influence each other. T2000 also measures AC current up to 20A and leakage current with resolution 0.1mA.

This devices comply with standard IEC/EN61010-1 in CAT III 600V, CAT IV 300V and they are the ideal solution for measurements to be carried out both in domestic and in industrial environments.

Functions

- Earth resistance with stakeless testing method
- Measurement of leakage current on earth systems (**only T2000**)
- Setting of alarm thresholds on measurements
- Storage of measurement results
- Detection of disturbance currents on measurement
- Data HOLD, Backlight, Auto Power OFF
- Maximum diameter for clamp 31mm (bars 48x31mm)
- Serial interface RS-232 for connection to devices of **MacrotestG series (only T2100)**

Main features

Power supply:	batteries type AA 4x1.5V
Memory:	99 locations
Display:	LCD 4-digit display + decimal point, backlight
Pollution level:	2
Safety:	IEC/EN61010-1, IEC/EN61010-2-032 IEC/EN61557-5
Measurement category:	CAT III 600V, CAT IV 300V to earth
Size (LxWxH):	293x105x54mm
Weight (batteries included):	1120g

Technical Specifications

Resistance measurement

- Measuring range: 0.010 ÷ 1200Ω
- Resolution: 0.001 ÷ 1Ω
- Basic accuracy: ± (1.5%reading + 0.01)Ω

TRMS current measurement (**only T2000**)

- Measuring range: 0.00mA ÷ 20A
- Resolution: 0.01mA ÷ 0.01A
- Basic accuracy: ± (2.5%reading + 1mA)

Included accessories

	Resistive test loop (1Ω, 5Ω, 10Ω)
	Batteries
	User Manual
	ISO9000 calibration certificate
C2100	Connection cable Hypertac / Jack 3,5mm RS-232 (only T2100)
	Rigid Carrying case





ORDER CODE **HN002055**

HT2055

METER FOR STEP/CONTACT
VOLTAGE UP TO 50A

HT2055 consists in a **power unit** and a **voltmetric unit**, necessary for carrying out step and contact voltage measurements in **industrial installations (such as TN systems, transformer cabinets) with a rated test current up to 50A**. The two units, **synchronized** in time and current are capable of providing the correct value of step and contact voltages consistently with the real current values measured by the power unit, also taking into consideration the disturbance effects found on the measured circuit. It is also capable of measuring **earth resistance and ground resistivity by the classical voltammetric method**.

These measurements can be saved in the **internal memory** of the voltmetric unit and downloaded onto the PC through the provided Windows software.



Remote unit



Soft carrying bag for remote unit and accessories



Cable 10mm² with cable winder and alligator clip, 50m



Red measuring cable, 50m



Black measuring cable, 3m, with industrial plugs, 2 pieces

- Measurement of step/contact voltage with separate units
- Synchronization of units for correct measurements
- Test current selectable up to 50A
- LCD display on both units

- Earth resistance measurement
- Compensation function of disturbance effects
- Internal memory for measured data saving
- USB and RS-232 ports for communication between unit and PC

Characteristics

Power unit

- Power supply: 110/230V AC, 50/60Hz
- Output power: 900VA
- Output current: max 55A
- Test frequency: 55Hz
- Voltage measurement: 0.1 ÷ 999V
- Resolution: 0.1 ÷ 1V
- Basic accuracy: ±2%reading
- Display: LCD 240x128 dots + backlight
- Memory: 2000 locations
- Communication interface: RS-232
- Measurement category: CAT III 300V
- Protection: fuse T 6.3A/250V
- Pollution level: 2
- Mechanical protection: IP40 (closed case)
- Size (LxWxH): 335x335x160mm
- Weight: 28kg

Voltmetric unit

- Voltage measurement: 0.1 ÷ 999V
- Resolution: 0.1 ÷ 1V
- Resistance measurement: 0.001 ÷ 99.99Ω
- Resolution: 0.01Ω
- Basic accuracy: ±2%reading
- Input impedance: Selectable 1kΩ/1MΩ
- Display: LCD 240x128 dots + backlight
- Memory: 2000 locations
- Communication interface: RS-232/USB
- Power supply: 6x1.2V rechargeable batteries type AA
- Pollution level: 2
- Mechanical protection: IP40
- Size (LxWxH): 230x115x103mm
- Weight: 1.3kg

Included accessories

	Power supply cable of power unit
PC55SND	Metal plate (200x100mm), 2 pieces
	Current metal probe
	Voltage metal probe
PC55REL	Cable 10mm ² with winder and alligator clip, 50m
	Cable 10mm ² with alligator clip, 10m
PC55MBK	Black measuring cable, 3m, with industrial plugs, 2 pcs.
PC55GRE	Green measuring cable, 10m
PC55BLK	Black measuring cable, 1.5m
PC55RED	Red measuring cable, 50m
PC55MRE	Red connection cable with alligator clip, 1m
5004-IECN	Alligator clip, 4 pieces
	Cable RS-232
C2007	USB cable
	Soft transport bag, 2 pieces
	Strap for slinging the device over one's shoulder
	6 x 1.2V rechargeable batteries NiMH type AA
	External power supply
TERAVIEW	Windows software on CD-ROM
	User manual and ISO9000 calibration certificate

Optional accessories

PC55MBK	Black measuring cable, 3m, with industrial plugs, 2 pcs.
	For further information on optional accessories, please contact HT.

INSULATION AND CONTINUITY MEASURING DEVICES



INSULATION AND CONTINUITY MEASURING DEVICES



MAIN MEASUREMENTS	INSULATION/CONTINUITY					
	HT7052	HT7051	NEPTUNE	ISO410	M72	M70
TRMS	-	-	•	-	•	-
DC test voltage measuring range	500V ÷ 10kV	100V ÷ 5kV	50,100,250,500,1000V	50,100,250,500,1000V	250 / 500V	250, 500,1000V
Insulation resistance measuring range	120kΩ ÷ 10TΩ	0.01MΩ ÷ 9.99TΩ	0.01MΩ ÷ 1999MΩ	0.01MΩ ÷ 1999MΩ	0.00MΩ ÷ 999MΩ	0.001MΩ ÷ 4000MΩ
Dielectric strength in DC	•	-	-	-	-	-
Continuity of protective conductors with 200mA	-	-	•	•	•	•
Continuity 10A	-	-	-	-	-	-
ADDITIONAL FUNCTIONS						
Test with programmable ramp	• steps of 25VDC	• steps of 25VDC	-	-	-	-
Programmable test timer	• 1s ÷ 30min	• 5s ÷ 100min	• 15s ÷ 10min	• 10s ÷ 16,6min	-	• 2s ÷ 1min
Setting of measurement limit value	•	•	•	•	-	-
Measurement of polarization index P.I.	•	•	•	-	-	-
Measurement of dielectric absorption ratio D.A.R.	•	•	•	-	-	-
Measurement of dielectric discharge ratio D.D.	•	•	•	-	-	-
Measurement of discharge capacity	•	•	-	-	-	-
Automatic discharge of target	•	•	•	•	•	•
Measurement of DC/AC voltage up to 600V	• 600V	• 600V	• 1000V	-	• 600V	• 600V
Measurement of resistance and continuity with buzzer	-	-	•	-	•	•
Measurement of phase sequence	-	-	•	-	•	-
ADDITIONAL CHARACTERISTICS						
Measurement category	CAT IV 600V	CAT IV 600V	CAT IV 600V	CAT III 265V	CAT III 550V	CAT III 550V
Backlight	•	•	•	•	-	•
Autocalibration of measuring leads	-	-	•	•	•	•
Guard terminal	•	•	-	-	-	-
Measurements with remote terminal	-	-	-	•	-	-
Internal memory	•	•	-	•	-	-
Recalling on the display the saved results	•	•	-	•	-	-
RS232/optical/USB interface for transferring data onto the PC	•	•	-	•	-	-
Power supply with rechargeable battery from mains	•	•	-	-	-	-
AutoPowerOFF	-	•	•	•	•	•
Power supply	6x 1.2V NiMH LR20	Rechargeable NiMH	4x 1.5V AAA	6x 1.5V type AA	4x 1.5V AA	4x 1.5V AA
Size in mm (LxWxH)	360 x 330 x 160	360 x 310 x 195	175 x 85x 55	222 x 162 x 57	240 x 100 x 45	240 x 100 x 45
Weight (batteries included)	5.5kg	3.5kg	4.20 kg	1kg	450g	450g
Safety	IEC/EN61010-1 IEC/EN61557-2	IEC/EN61010-1 IEC/EN61557-1-2	IEC/EN61010-1 IEC/EN61557-1-2	IEC/EN61010-1	IEC/EN61010-1	IEC/EN61010-1
Order code	HV007052	HV007051	HR00NEPK	HV000410	HV000072	HV000070



ORDER CODE **HV007052**

HT7052

PROFESSIONAL INSULATION METER
WITH TEST VOLTAGE UP TO 10KV DC

HT7052 has been developed to measure **insulation resistance** with test voltage **programmable** up to **10kVDC** and **measuring range up to 10TΩ** which makes it very useful in any industrial application (tests on electric machines, power transformers, electric cables, electric boards, generic devices, etc.). The device allows measuring parameters such as **Polarization Index (PI)** and **Dielectric Absorption Ratio (DAR)** and **Dielectric Discharge (DD)**, diagnostic tests which allow determining the quality of an insulating material. It carries out **"ramp"** insulation tests and **dielectric strength test in DC**. HT7052 is supplied with NiMH rechargeable battery with integrated battery charger, which allows for a remarkable duration when carrying out measurements, it is provided with **internal memory** for saving measurements and it is also possible to connect it to the PC to download the measured results. The device has been inserted into a comfortable and resistant transport case, solid and safe for "on-site" use.



ORDER CODE **HV007051**

HT7051

PROFESSIONAL INSULATION METER
WITH PROGRAMMABLE TEST VOLTAGE
UP TO 5KV

HT7051 has been developed to measure **insulation resistance** with test voltage **programmable** up to **5kVDC** and measuring range up to **10TΩ** which makes it very useful in any industrial application (tests on electric machines, power transformers, electric cables, electric boards, generic devices, etc.). The device allows carrying out tests in **FIX** (with fixed test voltages), **ADJUST** (programmable test voltage) and **RAMP** mode (**programmable test voltage and application time with selection of 3 available ramp types**) which define a kind of operation suitable for any situation. Measurement of parameters such as **Polarization Index (PI)** and **Dielectric Absorption Ratio (DAR)**, are duration tests which allow defining the quality of insulation. HT7051 is supplied with **NiMH rechargeable battery** with integrated battery charger, which allows for a remarkable duration when carrying out measurements, it is provided with **internal memory** for saving measurements and it is also possible to connect it to the PC to download the measured results. The whole structure has been inserted into a comfortable and resistant transport case, solid and safe for "on-site" use.



Functions and characteristics

- Insulation with test voltage from 500 to 10kVDC in steps of 25VDC
- Measuring range up to 10TΩ
- Timer programmable from 1s to 30min
- Diagnostic tests on materials (PI, DAR, DD)
- Insulation resistance with programmable "ramp"
- Dielectric strength up to 10kVDC
- Measurement of DC/AC voltage up to 600V
- Measurement of Capacitance of the target
- GUARD terminal for surface current compensation
- Automatic discharge of test object
- **Backlight display**
- **Internal memory for saving results**
- **Recalling on the display the saved results**
- RS-232 and USB serial interface for transferring data onto the PC
- Power supply with rechargeable battery from power
- Display: Custom LCD with backlight and bargraph
- External power supply: 90-260V AC, 45-65Hz, 70VA
- Internal power supply: rechargeable batteries
- Duration: 4 hours (test with 10kV)
- Internal memory: 1000 locations
- PC interface: RS232 and USB
- Insulation: double insulation
- Pollution level: 2
- Mechanical protection: IP53 (closed case)
- Measurement category: CAT IV 600V
- Size (LxWxH) and weight: 330x360x160mm, 5.5kg

Included accessories

	Red terminal, protection 10kV, 2m
	Terminals (red/black), protection 10kV, 2m, 2 pieces
	Terminals (red/black), protection 10kV, 2 pieces
	Green guard terminal
5004-IECV	Green alligator clip
	Power supply cable
	USB cable
	Cable RS-232
	Software "TeraView" on CD-ROM
	6 x 1.2V rechargeable batteries NiMH IEC LR20
	User Manual
	ISO9000 calibration certificate

Optional accessories

For further information on optional accessories, please contact HT.

Functions and characteristics

- Insulation with test voltage from 100V to 5kVDC
- Measuring range up to 10TΩ
- Measurement with fixed test voltages
- 3 test ramps, programmable in time and voltage
- SMOOTH function for steady measurement results
- Measurement of dielectric discharge current
- Measurement of polarization index (P.I.)
- Measurement of dielectric absorption ratio (D.A.R.)
- Measurement of discharge capacity
- DC/AC TRMS voltage up to 600V
- Rechargeable internal NiMH battery
- GUARD terminal
- Automatic discharge of the test object
- **Display: Custom LCD with backlight and bargraph**
- **External supply: power 220-240V, 50/60Hz, 20VA**
- **Internal supply: rechargeable internal NiMH battery**
- **Protection fuse: T 200mA H 250V**
- **Battery life: >1000 tests (@ 5kV on 5MΩ)**
- **AutoPowerOFF: after 5 minutes' idling**
- **Internal memory: 700 locations**
- **Serial interface: RS-232 optically insulated**
- **Safety: IEC/EN61010-1, IEC/EN61557-1**
- Insulation: double insulation
- Pollution level: 2
- Mechanical protection: IP53 (closed case)
- Measurement category: CAT IV 600 (to earth),
- Size (LxWxH) and weight: 360x310x195 mm, approx. 3.5kg

Included accessories

KIT14000	Set of 3 cables with alligator clips + 2 cables with leads
C7051	Power supply cable Europlug-Schuko with no earthing
BORSA2000	Transport bag for accessories
TOPVIEW	Windows software for PC + cable RS-232
	ISO9000 calibration certificate
	User Manual

Optional accessories

C2009	RS232-USB adapter
-------	-------------------



ORDER CODE **HR000NEP**

NEPTUNE

PROFESSIONAL DEVICE FOR ELECTRIC SAFETY TESTS AND ADVANCED MULTIMETER FUNCTIONS

NEPTUNE is an innovative device which, further to being used as powerful multimeter for **TRMS** measurements, allows performing electric safety tests (Insulation and continuity). It belongs to CAT IV at 600V, with autorange function and backlit display. The design is extremely modern and attractive but, at the same time, ergonomic, to offer the best possible ease of use.



ORDER CODE **HV000410**

ISO410

MULTIFUNCTION DEVICE FOR MEASURING INSULATION AND CONTINUITY OF PROTECTIVE CONDUCTORS

ISO410 has been developed to measure **Insulation up to 1000VDC** and **Continuity of protective and equipotential conductors with 200mA**. This device is **very easy to use** and has an innovative structure with no mechanical commutators, which makes it extremely solid and resistant. It allows activating measurements by means of a **remote switch probe** (optional accessory **PR400**), very comfortable when carrying out measurements in a sequence. The context **help on line**, selectable by the user and active for any function, is a useful aid when connecting the device to the system to be tested. The **internal memory** allows saving the measurements carried out in order to subsequently **transfer them onto the PC** through the serial connection. Each measurement is saved together with all its sub-results and test parameters, as well as with two identifiers (which can be set by the user) in order to better identify the spot in which measurement was carried out.



Functions and characteristics

Multimeter section

- DC / AC, AC+DC TRMS voltage
- Input of low-impedance voltage
- DC / AC / AC+DC TRMS current with optional standard clamp transducer
- AC TRMS current up to 3000A with flexible clamp transducer F3000U
- Automatic recognition of AC and DC quantities
- Resistance and continuity test with buzzer
- Current and voltage frequency
- MAX/MIN/PEAK/HOLD functions
- 9999 measuring spots
- Auto-Power-Off function
- Bargraph function

Electric verification section

- Phase sequence with 1 terminal
- Insulation with test voltage 50, 100, 250, 500, 1000V with PI and DAR calculation
- Continuity of protective conductors with 200mA

Section Mains analysis

- Inrush current (Dynamic INRUSH - DIRC)
- Current/voltage harmonics up to the 25th and THD% calculation

Included accessories

4324-2	Pair of test tips Red/Black 2/4mm straight banana
	Pair of Red / Black alligator clips
YABAT0001HTO	Alkaline battery 1.5V, type AAA, IEC LR03, 4 pcs
YABRS0002HTO	Carrying bag
YAMUM0066HTO	User manual on CD-ROM
YAMUM0065HTO	Quick reference guide
	Calibration certificate ISO9000

Optional accessories

606-IECN	Connector with magnetic terminal
F3000U	AC flexible clamp with 30/300/3000A full scales
HT96U*	AC current clamp with 1/100/1000A full scales
HT97U*	AC current clamp with 10/100/1000A AC full scales
HT98U*	DC current clamp with 1000A full scale
HT4006	AC/DC current clamp with 40/400A full scales
NOCANBA	Hypertac-to-banana adapter
5004-IECR	Red alligator clip
5004-IECN	Black alligator clip
C2065	3-wire cable Red, Black and Green with Schuko plug

The standard accessories can be different depend on countries.
* Adapter NOCANBA required.

Functions and characteristics

- Continuity of protective conductors with 200mA
- Insulation with 50, 100, 250, 500, 1000VDC
- Insulation measuring range 0.01MΩ-2GΩ
- Automatic discharge of measured object
- Autocalibration of measuring leads
- Setting the limit on measurement
- Activation of measurements with optional remote lead PR400
- Context help on the display
- Storage of results
- Optical/USB interface for PC connection
- **Safety: IEC/EN61010-1**
- **Measurement category CAT III 265V**
- **Power supply 6 x 1.5V batt. type AA**
- **Size (LxWxH): 222x162x57mm**
- **Weight (batteries included): 1kg**

Included accessories

UNIVERSALKITCOMBI	Set of 3 cables + 3 alligator clips + 3 leads
BORSA75	Soft carrying bag
	ISO9000 calibration certificate
	User manual on CD-ROM
	Quick user guide

Optional accessories

TOPVIEW2006	Windows software for PC + optical/USB C2006 cable
VA500	Rigid transport case for device and accessories
PR400	Remote lead for test activation
SP-0400	Set of straps for slinging the instrument over one's shoulder



→ **TRMS**

ORDER CODE **HV000072**

M72

COMBINED DEVICE FOR INSULATION MEASUREMENT, CONTINUITY OF PROTECTIVE CONDUCTORS AND MULTIMETER FUNCTION

M72 is mainly dedicated to measuring **Insulation resistance** and **Continuity of protective and equipotential conductors with 200mA** in electric installations, typically domestic. Further to these measurements, M72 has many **additional functions** such as **measurement of phase sequence with 1 terminal**, measurement of **leakage currents** with optional clamp transducer and a powerful **multimeter** function for measuring **voltage and current** in true root mean square value (**TRMS**).



ORDER CODE **HV000070**

M70

COMBINED DEVICE FOR MEASURING INSULATION AND CONTINUITY OF PROTECTIVE AND EQUIPOTENTIAL CONDUCTORS

M70 is a mobile device dedicated to measuring **Insulation resistance with test voltage up to 1000VDC** and **Continuity of protective and equipotential conductors with current of 200mA** in domestic and industrial electric installations.

Thanks to the **LOCK function**, insulation measurement can be carried out in a **continuous manner over time**, thus testing the insulation of the target with a **duration test**. It carries out measurement with a timer, **programmable from 2 to 60s**.

Functions and characteristics

- Continuity of protective conductors with 200mA
- Insulation with 250,500VDC
- Insulation measuring range 0.01MΩ-2GΩ
- Automatic discharge of measured object
- Autocalibration of measuring leads
- Phase sequence
- DC/AC TRMS voltage
- DC/AC TRMS current
- Resistance and Continuity test
- Data HOLD, MAX/MIN/AVG
- Measurement of voltage and current PEAK
- Measurement of leakage currents (with optional clamp HT96U)
- **Safety: IEC/EN61010-1**
- **Measurement category: CAT III 550V**
- **Power supply: 4x1.5V batt. type AA**
- **Size (LxWxH): 240x100x45 mm**
- **Weight (batteries included): 450g**

Included accessories

KIT0075	Set of 2 cables with leads + 2 alligator clips
BORSA2000	Soft carrying bag
	ISO9000 calibration certificate
	User manual on CD-ROM
	Quick user guide

Optional accessories

HT96U	Standard 1-100-1000A/1V clamp, diameter 54mm
HT4003	Standard 400A AC clamp
HT4004N	Standard 10-100A DC/1V clamp
HT4005N	Standard 5-100A AC/1V clamp
NOCANBA	Adapter for connect. HT96U, HT4004N, HT4005N

Functions and characteristics

- Insulation with test voltage 250, 500, 1000VDC
- Measuring range up to 4GΩ
- Automatic discharge of measured object
- LOCK function for measurements in a continuous mode
- Insulation with timer programmable from 2 to 60s
- Continuity of protective conductors with 200mA
- Autocalibration of measuring leads
- AC/DC voltage up to 600V
- Resistance and continuity test with buzzer
- Wide display with backlight
- AutoPowerOFF
- **Display with backlight: LCD, 4 digits, 10000 dots**
- **Power supply: 4x1.5V batteries type AA**
- **AutoPowerOFF: after 15 minutes' idling**
- **Safety: IEC/EN61010-1**
- **Measurement category: CAT III 550V**
- **Size (LxWxH): 240x100x45 mm**
- **Weight (batteries included): 450g**

Included accessories

KIT0070	Set of 2 cables + 2 alligator clips + 1 lead
BORSA2000	Soft carrying bag
	Batteries
	CE declaration of conformity
	User Manual

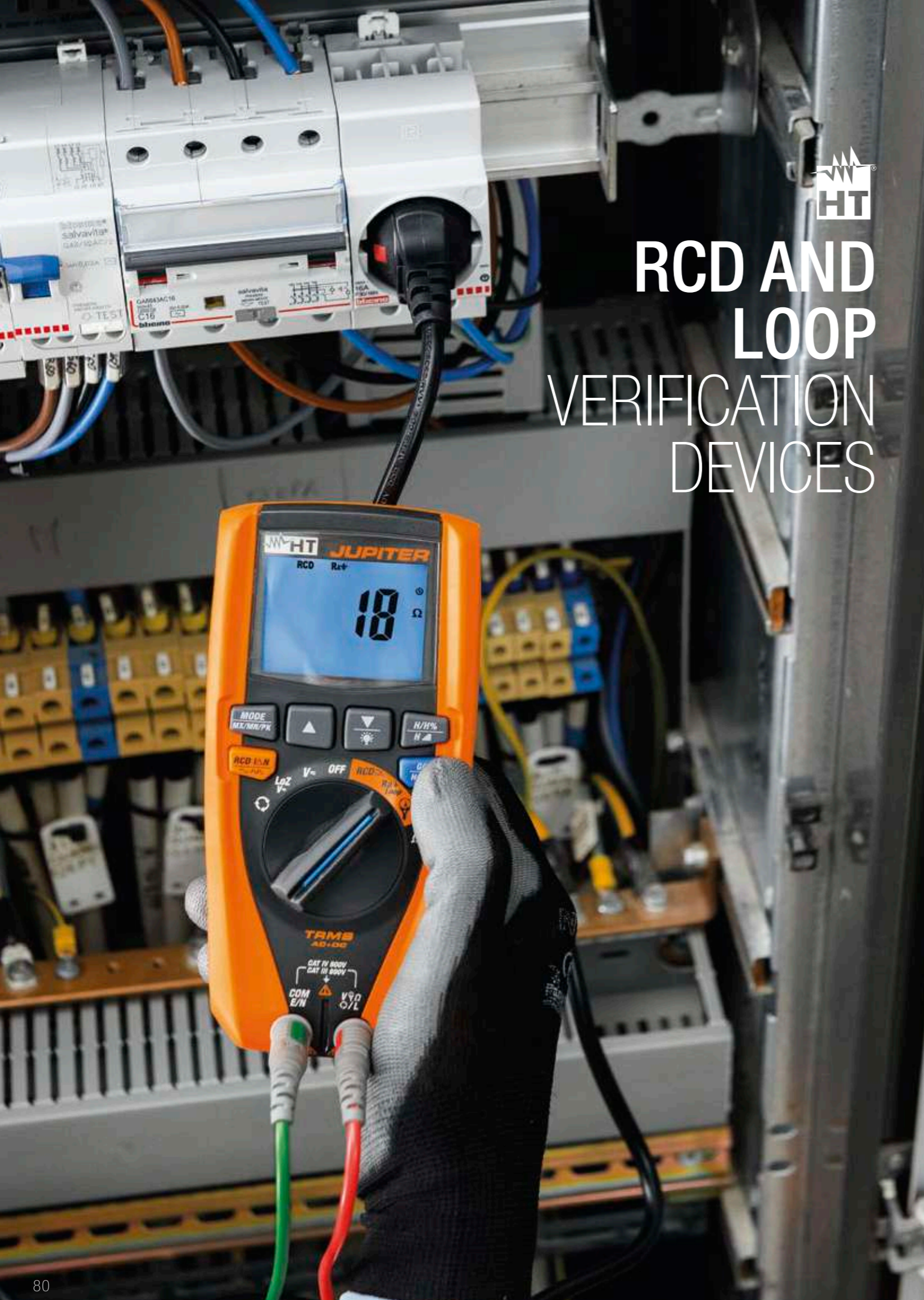

RCD AND LOOP VERIFICATION DEVICES

RCD AND LOOP VERIFICATION DEVICES

NEW



JUPITER



SPEED418



M73

MAIN MEASUREMENTS

TRMS

	LOOP/RCD		
Measuring range of verifiable RCD rated currents	• 30,100,300mA	• 10,30,100,300,500,650,1000mA	• 30,30x5,100,300mA
Tripping time of type A, AC General and Selective RCDs	• Only general	• Up to 1A	• A = 30mA AC = 300mA Only general
Ramp test for tipping current of RCDs type A, AC Standard	• Only 30mA	• Up to 650mA	• A = 30mA AC = 30mA
Overall earth resistance with no residual current protection tripping	•	•	•
Loop/Line impedance, Phase-Phase, Phase-Neutral, Phase-PE	•	•	-
Loop/Line impedance Phase-Phase Phase-Neutral, Phase-PE with high resolution (0.1mΩ)	-	•*	-
Contact voltage	•	•	•
Leakage current with optional clamp	•	-	•

ADDITIONAL FUNCTIONS

DC/AC TRMS voltage and current	• AC+DC, LoZ function	-	•
Phase sequence	•	•	•
Frequency	•	-	•
Resistance	•	-	•
Continuity with buzzer	•	-	•
Data HOLD, MAX/MIN/AVG	• MAX/MIN	-	•
Measurement of voltage and current PEAK	•	-	•
Measurement of Voltage/Current harmonics + THD%	•	-	-

ADDITIONAL CHARACTERISTICS

	CAT IV 600V CAT III 690V	CAT III 265V	CAT III 550V
Measurement category	CAT IV 600V CAT III 690V	CAT III 265V	CAT III 550V
AUTOMATIC Test	-	•	-
Test with remote lead	-	•	-
Help on line on the display	-	•	-
Internal memory	-	•	-
Optical/USB serial port for PC connection	-	•	-
Size (LxWxH) (mm)	175x85x55	222x162x57	240x100x45
Weight (batteries included)	420g	1kg	450g
Reference standard for safety	IEC/EN61010-1	IEC/EN61010-1	IEC/EN61010-1
Order code	HR00JUPI	HV000418	HV000073

RCD AND LOOP VERIFICATION DEVICES



ORDER CODE **HR00JUPI**

JUPITER

PROFESSIONAL DEVICE FOR ELECTRIC SAFETY TESTS AND ADVANCED MULTIMETER FUNCTIONS

The new JUPITER is an innovative device which, further to being used as **powerful multimeter** for TRMS measurements, allows performing **electric safety tests (RCD, Ra, Loop)**. The device belongs to CAT IV at 600V, with **autorange** function available on all models and possibility of backlit display. The design is extremely modern and attractive but, at the same time, **ergonomic**, to offer the best possible ease of use.



Functions and characteristics

Multimeter section

- DC / AC, AC+DC TRMS voltage
- DC / AC / AC+DC TRMS voltage with low impedance (LoZ)
- DC / AC / AC+DC TRMS current with with standard clamp transducer
- AC TRMS current up to 3000A with flexible clamp transducer F3000U
- Automatic recognition of AC and DC quantities
- Resistance and continuity test with buzzer
- Current and voltage frequency
- MAX/MIN/PEAK/HOLD functions
- 9999 measuring spots
- Auto-Power-Off function
- Bargraph function

Electric verification section

- Overall earth resistance L-PE without RCD tripping
- Loop impedance L-L, L-N and calculation of assumed short-circuit current
- Measurement of tripping time on General RCDs type A and AC (30mA, 100mA, 300mA)
- Measurement of tripping current on General RCDs type A and AC (30mA)
- Phase sequence with 1 terminal

Section Mains analysis

- Inrush current (Dynamic INRUSH - DIRC)
- Current/voltage harmonics up to the 25th and THD% calculation

Included accessories

C2065	Three-wire cable Red, Black, Green with Schuko plug
4324-2	Pair of test tips Red/Black 2/4mm straight banana
YABAT0001HTO	Alkaline battery 1.5V, type AAA, IEC LR03, 4 pcs
YABRS0002HTO	Carrying bag
YAMUM0066HTO	User manual on CD-ROM
YAMUM0065HTO	Quick reference guide
	Calibration certificate ISO9000

Optional accessories

606-IECN	Connector with magnetic terminal
F3000U	AC flexible clamp with 30/300/3000A full scales
HT96U*	AC current clamp with 1/100/1000A full scales
HT97U*	AC current clamp with 10/100/1000A AC full scales
HT98U*	DC current clamp with 1000A full scale
HT4006	AC/DC current clamp with 40/400A full scales
NOCANBA	Hypertac-to-banana adapter
5004-IECR	Red alligator clip
5004-IECN	Black alligator clip

Standard accessories can be different depending on the country.
* Adapter NOCANBA required.





ORDER CODE **HV000418**

SPEED418

MULTIFUNCTION DEVICE
FOR NON-TRIP EARTH RESISTANCE
MEASUREMENT AND RCD TESTS

SPEED418 has been specifically developed to measure **Non-trip earth resistance** directly at the outlets to be measured and for **operating tests of RCDs type A, AC General and Selective** with tests both in manual and **automatic** mode in domestic electric installations. Extremely simple to use, with setting of parameters via scroll-through menu. It has no mechanical commutators and it is therefore more solid in structure. The device is provided with an **internal memory** for saving measurements and with an optical/USB interface for transferring measured data onto the PC. At the end of the test, the device shows all results with the indication of compliance or non-compliance with the standards with **simple symbols OK or NOT OK.**



ORDER CODE **HV000073**

M73

MULTIFUNCTION DEVICE
FOR NON-TRIP EARTH RESISTANCE
MEASUREMENT AND RCD TESTS

M73 has been developed for operators who mainly work on domestic installations.

M73 is very easy to use, it is very small in size and it carries out all necessary tests to establish COMPLIANCE (and hence ensure SAFETY) of a domestic electric system.

By always using it before starting working on an already existing system (which the operator therefore does not know well) and at the end of the job, this device will guarantee the necessary safety to both operators and users of the electric systems! Thanks to its small size, this device offers many operating opportunities.

M73 is also used to test the safety of electric system; it is therefore capable of measuring **Non-trip earth resistance**, carrying out **tests on RCDs type A and AC** and **measuring Insulation and Continuity.**

At the end of the test, the device shows all results with the indication of compliance or non-compliance with the standards with **simple symbols OK or NOT OK.**



TRMS

Functions and characteristics

- Tripping time of type A, AC General and Selective RCDs with test currents 10,30,100,300,500,650,1000mA
- Tripping current of type A, AC General RCDs 10,30,100,300,500,650mA
- Non-trip earth resistance
- Line/Loop impedance also with high resolution (0.1 mΩ) with optional accessory IMP57
- Prospective short-circuit current
- Phase sequence
- Activation of measurements with (optional remote lead PR400)
- Context help on the display
- Storage of results
- Optical/USB interface for PC connection
- **Safety: IEC/EN61010-1**
- **Measurement category: CAT III 265V**
- **Power supply with batteries type AA: 6x1.5V**
- **Size (LxWxH): 222x162x57mm**
- **Weight (batteries included): 1kg**

Included accessories

C2033X	3-wire cable with Shuko plug
BORSA75	Soft carrying bag
	ISO9000 calibration certificate
	User manual on CD-ROM and Quick guide for use

Optional accessories

TOPVIEW2006	Windows software for PC + optical/USB cable
UNIVERSALKITCOMBI	Set of 3 cables + 3 alligator clips + 3 leads
IMP57	Accessory for measuring Loop impedance with high resolution
PR400	Remote lead for test activation
SP-0400	Set of straps for slinging the instrument over one's shoulder
VA500	Rigid transport case for device and accessories

Functions and characteristics

- Tripping time of type A, AC General RCDs with currents 30,30x5,100,300mA
- Tripping current of type A, AC General RCDs with 30mA test current
- Non-trip earth resistance
- Prospective short-circuit current
- Phase sequence
- DC/AC TRMS voltage
- DC/AC TRMS current
- Resistance and Continuity test
- Data HOLD, MAX/MIN/AVG
- Measurement of voltage and current PEAK
- Measurement of leakage currents (with optional clamp HT96U)
- **Safety: IEC/EN61010-1**
- **Measurement category: CAT III 550V**
- **Power supply with batteries type AA: 4x1.5V**
- **Size (LxWxH): 240x100x45mm**
- **Weight (batteries included): 450g**

Included accessories

KIT0075	Set of 2 cables with leads + 2 alligator clips
C2075	2-wire cable with Shuko plug
BORSA2000	Soft carrying bag
	ISO9000 calibration certificate
	User manual on CD-ROM
	Quick user guide

Optional accessories

HT96U	Standard 1-100-1000A/1V clamp, diameter 54mm
HT4003	Standard 400A AC clamp
HT4004N	Standard 10-100A DC/1V clamp
HT4005N	Standard 5-100A AC/1V clamp
NOCANBA	Adapter for connect. HT96U, HT4004N, HT4005N



PROCESS CALIBRATORS

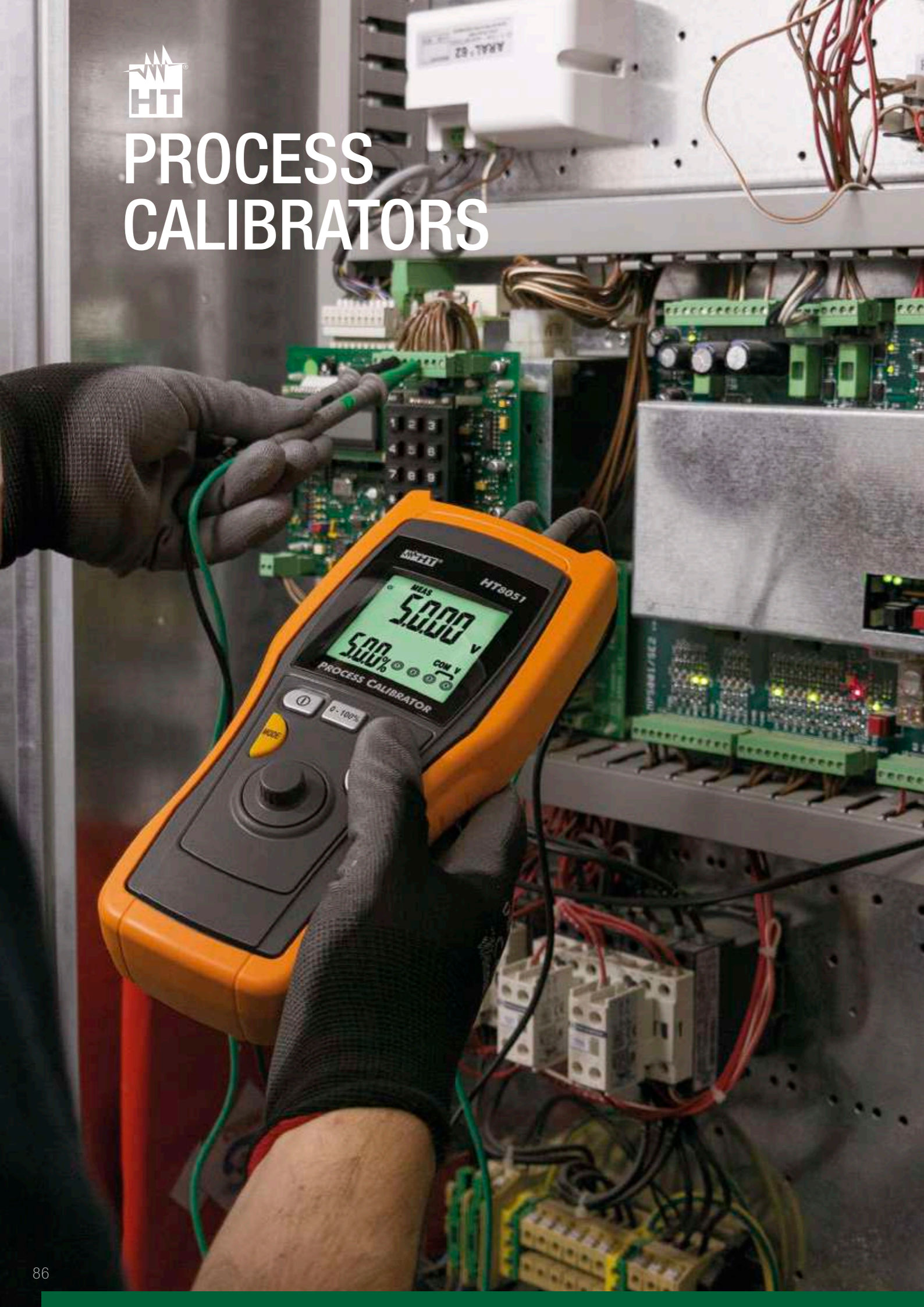

PROCESS CALIBRATORS



HT8051



HT8100

CALIBRATION MEASUREMENTS

	HT8051	HT8100
TRMS	•	•
DC 4-20mA current measurement	•	•
DC 0-10V voltage measurement	•	•
DC 4-20mA current generation	•	•
DC 0-10V voltage generation	•	-
Measurement of output current of transducers	•	•
Simulation of an external transducer	•	•
Loop supply with minimum voltage 24V	•	•
Generation of selectable ramp	•	•
Load of 250Ω for testing HART transducers	-	•

MULTIMETER MEASUREMENTS

AC/DC voltage	• MAX 10VDC	•
AC+DC voltage	-	•
AC/DC current	• MAX 24mADC	• 1A
AC+DC current	-	•
Resistance and buzzer continuity	-	•
Frequency	-	•
Diode test	-	•

ADDITIONAL CHARACTERISTICS

Measurement category	CAT IV 600V	CAT IV 600V
Measuring counts	-	50.000
Backlight	•	•
Autorange	-	•
Auto power off	•	•
Data HOLD function	-	•
MIN/MAX function	-	•
AVG function	-	•
Relative measurement	-	•
Internal memory	-	•
Power supply	1x7.4/8.4V 600mAh Li-ION	4x1.5V AA
Size (LxWxH) (mm)	195x92x55	207x95x52
Weight (batteries included)	400g	630g
Safety	IEC/EN61010-1	IEC/EN61010-1
Order code	HV080510	HV08100



ORDER CODE HV080510

HT8051

PROFESSIONAL PROCESS CALIBRATOR

HT8051 is a professional **process calibrator** capable of **generating and measuring DC voltage and current signals** up to **10V** and **24mA** respectively, with a very simple setting of values thanks to the innovative adjuster. In measuring and generating current, it is also possible to define a **display, also in percentage format**, corresponding to the set values (**0% = 4mA, 100% = 20mA**). The generation of voltage and current signals is also possible by using up to **3 selectable ramps**. This model also allows **measuring the current absorbed** by external transducers directly supplied by them and **simulating the presence of a transducer** with adjustable current in its whole measuring range. The device has been designed in compliance with **safety standard IEC/EN61010-1** with double protective insulation, and each function can be selected through the appropriate buttons found on the front panel. HT8051 is the ideal solution for typical industrial automation applications and for laboratory activities.



ORDER CODE HV008100

HT8100

PROFESSIONAL PROCESS CALIBRATOR/MULTIMETER



HT8100 is a professional device which groups measurements such as **TRMS multimeter** and function of **process calibrator** capable of **generating current signals DC 0-20mA and 4-20mA**. As a digital multimeter, the device mainly carries out **AC/DC voltage and AC/DC current measurements**. In its function as a current generator (values can be displayed also in a percentage format) options 0-20mA and 4-20mA are available, with manual and automatic settings of **thresholds on the output signal**. This model also allows measuring the **current absorbed by external transducers directly powering them and simulating the presence of a transducer with adjustable current** in its whole measuring range. HT8100 is capable of saving the results of measurements in its **internal memory** and has been designed in compliance with **safety standard IEC/EN61010-1** in CAT III 1000V and **CAT IV 600V** with double protective insulation. Each function can be selected through the appropriate buttons found on the front panel. This device is the ideal solution for typical industrial automation applications.

Functions

- Generation of voltage signal with amplitude up to 10VDC
- Measurement of voltage up to 10VDC
- Generation of current signal with amplitude up to 24mA DC
- Measurement of current up to 24mA DC
- Generation of voltage and current signals by means of 3 selectable ramps
- High-sensitivity adjustment selector
- Display of current as a percentage (4-20mA)
- Measurement of transducers output current (Loop)
- Simulation of an external transducer
- Shortcut function keys
- Powering with rechargeable Li-ION battery

DC voltage (generated and measured)

- Reading range: 0.01mV ÷ 10V
- Resolution: 0.01mV ÷ 0.001V
- Standard accuracy: ± (0.02% reading + 4digits)
- Protection: 30VDC

DC voltage (generated and measured)

- Reading range: 0.001mA ÷ 24mA
- Percentage: -25% ÷ 125%
- Resolution: 0.001mA
- Standard accuracy: ± (0.02% reading + 4digits)
- Protection: 30mADC

Output voltage and current ramps

- **▲** (slow linear ramp): Goes from 0% →100% → 0% in 40s
- **⚡** (quick linear ramp): Goes from 0% →100% → 0% in 15s
- **▬** (step ramp): Goes 0% →100% → 0% through steps of 25% with ramps of 5s

Main features

Display:	5 LCD + secondary display
Power supply:	1x7.4V rechargeable Li-ION battery
External battery charger:	230VAC/50Hz - 12VDC
Autonomy:	about 8 hours in generation (@ 12mA, 500Ω)
Auto Power OFF:	after 20 minutes (adjustable) of non-use
Safety:	IEC/EN61010-1
Insulation:	double insulation
Level of pollution:	2
Measurement category:	CAT I 30V
Dimensions (LxWxH):	195x92x55mm
Weight (battery included):	400g

Included accessories

KIT0075	Couple of leads, two crocodile clip terminals
	Protective cover
	Rechargeable battery, External battery charger
	User manual
	Hard case for transport

Functions

- DC/AC TRMS voltage and current
- AC+DC measurements
- Automatic recognition of AC/DC signals
- Resistance, continuity test, diode test
- Frequency
- DC current generation up to 20mA DC
- Percentage display (0-20mA, 4-20mA)
- Measurement of output current of transducers (Loop)
- Simulation of an external transducer
- Input protective fuses
- Memory for measured data saving
- MAX/MIN/AVG, Data HOLD
- Relative measurement
- Automatic/Manual Range
- Auto Backlight, Auto Power OFF

Main features

Display:	LCD, 5 digits, 50000 dots
Power supply:	4x1.5V alkaline batteries type AA LR6
Battery life:	120 hours
Auto Power OFF:	after 20 minutes' idling
Safety:	IEC/EN61010-1
Measurement category:	CAT III 1000V, CAT IV 600V
Insulation:	double insulation
Pollution level:	2
Max height:	2000m
Size (LxWxH):	207x95x52mm
Weight (batteries included):	630g

Included accessories

YAAMK0000HTO	Pair of 4mm test leads
YAAMK0001HTO	Pair of alligator clips
	Belt with magnetic terminal
	Protective case, battery and user manual

Technical Specifications

- DC voltage**
 - Measuring range: 0.001mV ÷ 1000V
 - Resolution: 0.001mV ÷ 1.V
 - Basic accuracy: ±(0.05%reading + 5 digits)
 - Protection: 1000V DC/ACrms
- AC TRMS voltage**
 - Measuring range: 0,001mV ÷ 1000V
 - Resolution: 0.001mV ÷ 1.V
 - Basic accuracy: ±(0.5%reading + 20 digits)
 - Protection: 1000V DC/ACrms
- DC current (measured)**
 - Measuring range: 0.001mA ÷ 1A
 - Resolution: 0,001mA
 - Basic accuracy: ±(0.05%reading + 5 digits)
 - Protection: Fuse F440mA/1000V
- DC current (generated)**
 - Measuring range: 0.000mA ÷ 20,000mA
 - Resolution: 0.001mA
 - Basic accuracy: ±0.002mA
 - Protection: Fuse F440mA/1000V
- AC TRMS current (measured)**
 - Measuring range: 0,001mA ÷ 1A
 - Resolution: 0,001mA
 - Basic accuracy: ±(1%reading + 20 digits)
 - Protection: Fuse F440mA/1000V
- Resistance and Continuity test**
 - Measuring range: 0.1Ω ÷ 50MΩ
 - Resolution: 0.01Ω ÷ 1kΩ
 - Basic accuracy: ±(0.2%reading + 10 digits)
 - Continuity test: <30Ω
 - Protection: 1000V DC/ACrms
- Frequency**
 - Measuring range: 5Hz ÷ 100kHz
 - Resolution: 0.01Hz ÷ 10Hz
 - Basic accuracy: ±(3 digits)
 - Protection: 1000V DC/ACrms



MULTIMETERS

PROFESSIONAL TRMS MULTIMETERS

NEW



HT65



HT64



HT63



HT62



HT61

NEW



JUPITER

NEW



NEPTUNE

NEW



MERCURY



FLASHMETER



IRONMETER



HT39



HT701



HT401



HT712

MAIN MEASUREMENTS

	PROFESSIONAL TRMS MULTIMETERS						PROFESSIONAL TRMS MULTIMETERS								
TRMS	•	•	•	•	•	•	•	•	•	•	•	•	•	•	•
AC/DC voltage	• 1500VDC	• AC+DC	•	•	•	• AC+DC	• AC+DC	• AC+DC	•	•	•	•	•	• AC+DC	•
AC/DC voltage with low impedance (LoZ)	•	•	•	•	•	•	•	-	-	-	-	-	-	• AC	-
AC/DC current with external transducer	•	•	•	-	-	• Inrush	• Inrush	• AC+DC	-	-	-	-	-	-	-
AC/DC current with leads	-	• AC+DC	• AC+DC	•	•	-	-	•	-	•	•	•	•	• AC+DC	-
4-20mA% reading	-	•	•	-	-	-	-	-	-	-	-	-	-	-	-
Frequency	•	•	•	•	•	•	•	•	-	•	•	•	•	•	•
Resistance	•	•	•	•	•	•	•	•	•	•	•	•	•	•	•
Continuity with buzzer	•	•	•	•	•	•	•	•	•	•	•	•	•	•	•
Capacitance	•	•	•	•	-	-	-	•	-	•	•	•	•	•	-
Diode test	•	•	•	•	•	-	-	•	-	•	•	•	•	•	-
Duty Cycle (%)	•	•	•	•	•	-	-	•	-	•	•	•	-	-	-
Temperature with K-type probe	•	•	•	•	-	-	-	•	-	-	-	-	•	•	-
Insulation measurement (50,100,250,500,1000VDC)	-	-	-	-	-	-	•	-	-	-	-	-	•	-	-
Phase sequence and concordance	-	-	-	-	-	•	•	-	-	-	-	-	-	-	• + Conformity
Built-in LED torch	-	-	-	-	-	-	-	•	-	•	-	-	-	-	-
Test on A and AC general RCDs	-	-	-	-	-	•	-	-	-	-	-	-	-	-	-
L-L, L-N, L-PE, RA loop impedance	-	-	-	-	-	•	-	-	-	-	-	-	-	-	-
Voltage/Current harmonics + THD%	-	-	-	-	-	•	-	-	-	-	-	-	-	-	-
Continuity of protective conductors with 200mA	-	-	-	-	-	-	•	-	-	-	-	-	-	-	-

ADDITIONAL CHARACTERISTICS

Measurement category	CAT IV 600V CAT III 1000V	CAT IV 600V	CAT IV 600V	CAT IV 600V	CAT IV 600V	CAT IV 600V CAT III 690V		CAT IV 600V CAT III 1000V	CAT IV 600V CAT III 1000V	CAT IV 600V	CAT III 600V	CAT IV 600V CAT III 1000V	CAT IV 600V CAT III 1000V	CAT IV 600V CAT III 1000V	CAT IV 600V
Measuring counts	4000	6000	60.000	6000	6000	9999		9999	6000	4000	4000	4000	10000	6000	4000
Backlight	•	•	•	•	•	•		•	•	•	•	•	•	•	-
IR sensor resolution	-	-	-	-	-	-		-	• 80 x 80 pxl	-	-	-	-	-	-
Bluetooth	-	-	-	-	-	-		-	• with APP HTMercury	-	-	-	-	-	-
Bargraph	-	•	•	•	•	•		•	•	-	-	•	•	•	-
Autorange	•	•	•	•	•	•		•	•	-	•	•	•	•	•
Auto power off	•	•	•	•	•	•		•	•	•	•	•	•	•	•
Detection of AC voltage without contact	-	-	-	-	-	-		-	•	•	-	-	-	•	-
Data HOLD function	•	•	•	•	•	•		•	•	•	•	•	•	•	•
MIN/MAX/AVG functions	-	•	• MIN/MAX	• MIN/MAX	• MIN/MAX	• MIN/MAX		• MIN/MAX	• MIN/MAX	-	• MIN/MAX	• MIN/MAX	•	• MIN/MAX	-
PEAK function	-	• (1ms)	• (1ms)	-	-	• (1ms)		• (1ms)	•	-	-	•	-	•	-
Automatic recognition of AC/DC	-	-	-	-	-	•		•	-	•	-	-	-	-	•
Automatic recognition of internal functions	-	-	-	-	-	-		-	-	•	-	-	-	-	-
Relative measurement	•	•	•	•	•	-		-	•	-	-	•	•	-	-
Data logger and graph	-	•	-	-	-	-		-	•	-	-	• (through SW)	-	-	-
Memory for data saving	-	•	-	-	-	-		-	• (micro SD card)	-	-	-	•	-	-
Power supply	1x 9V 6F22	1x7.4V rechargeable Li-ION battery	4x 1.5V AAA	1x 9V 6F22	1x 9V 6F22	4x 1.5V AAA		4x 1.5V AAA	1x7.4V rechargeable Li-ION battery	2x 1.5V AAA	2x 1.5V AAA	1x 9V 6F22	4x 1.5V AA	1x 9V 6F22	2x 1.5V AAA
Size in mm (L x W x H)	175x85x55	175x85x55	175x85x55	175x85x55	175x85x55	175x85x55		175x85x55	190x75x55	135x75x40	120x85x45	164x82x44	207x95x52	190x94x48	250x51x30
Weight in grams	360	400	400	400	400	420		420	555	220	200	400	630	460	150
Safety	IEC/EN61010-1	IEC/EN61010-1	IEC/EN61010-1	IEC/EN61010-1	IEC/EN61010-1	IEC/EN61010-1		IEC/EN61010-1	IEC/EN61010-1	IEC/EN61010-1	IEC/EN61010-1	IEC/EN61010-1	IEC/EN61010-1	IEC/EN61010-1	IEC/EN61010-1
Order code	HR000065	HR000010	HR000001	HR000002	HR000003	HR00JUPI		HR00NEP	HR000MER	HR000011	HR000005	HR000039	HR000701	HR000401	HR000712

NEW



HT211

NEW



HT21

NEW



HT25N



HT14D



HT12

NEW



HT10



HT8



HT7



HT6

MAIN MEASUREMENTS

	DIGITAL MULTIMETERS				DIGITAL MULTIMETERS					
TRMS	•	-	-	-	-	-	-	-	-	-
AC/DC Voltage	•	•	•	•	•	•	•	•	•	•
AC/DC Current	•	-	• DC	• DC	• DC	•	-	-	-	-
Frequency	•	•	-	-	-	•	-	-	-	-
Resistance	•	•	•	•	•	•	•	-	-	-
Continuity with buzzer	•	•	•	•	-	•	•	•	•	•
Capacitance	•	•	-	-	-	-	-	-	-	-
Diode test	•	•	•	•	•	-	-	•	-	•
Duty Cycle (%)	•	•	-	-	-	-	-	-	-	-
Temperature with K-type probe	•	-	-	-	-	-	-	-	-	-
AC Voltage with low impedance input (LoZ)	-	-	-	-	-	-	•	-	•	-
AC Voltage with 1 terminal	-	-	-	-	-	-	•	•	•	•
Phase sequence and phase concordance	-	-	-	-	-	-	•	•	•	•
Built-in LED torch	-	-	-	-	-	-	•	•	•	•

ADDITIONAL CHARACTERISTICS

Measurement category	CAT III 600V	CAT III 600V	CAT III 600V		CAT III 300V CAT II 600V	CAT III 300V CAT II 600V	CAT III 1000V CAT IV 600V	CAT IV 600V CAT III 690V	CAT IV 600V CAT III 1000V	CAT IV 600V CAT III 690V
Measuring counts	4000	4000	2000		2000	3400	1999	6900	1999	LED indications
Backlight	•	•	•		-	-	•	-	•	-
Bargraph	-	-	-		-	•	-	-	•	-
Autorange	•	•	-		-	•	•	-	•	-
Auto power off	•	•	-		-	•	•	•	•	•
Data HOLD function	•	•	•		•	•	•	•	-	•
MIN/MAX function	•	-	-		-	-	-	-	-	-
PEAK function	-	-	-		-	-	-	-	-	-
Relative measurement	-	•	-		-	-	-	-	-	-
Power supply	2x 1.5V AAA	1x 9V 6F22	1x 9V 6F22		1x 12V MS21/MN21	2x 1.5V AAA	2x 1.5V AAA	2x 1.5V AA	2x 1.5V AAA	2x 1.5V AA
Size in mm (L x W x H)	138x68x37	138x68x37	150x70x48		105x50x25	128x87x24	270x70x30	255x60x35	240x78x40	255x60x35
Weight in grams	235	210	255		100	210	290	170	240	170
Safety	IEC/EN61010-1	IEC/EN61010-1	IEC/EN61010-1		IEC/EN61010-1	IEC/EN61010-1	IEC/EN61010-1	IEC/EN61010-1	IEC/EN61010-1 IEC/EN61243-3:2014	IEC/EN61010-1
Order code	HR000211	HR000021	HR00025N		HR00014D	HR000012	HR000100	HR000008	HR000007	HR000006



TRMS 1500VDC

ORDER CODE HR000010 | HR000001 | HR000002 | HR000003 | HR000005

HT65 | HT64 | HT63 | HT62 | HT61



SERIES OF TRMS / CAT IV
PROFESSIONAL DIGITAL MULTIMETERS
WITH DATA LOGGER FUNCTIONS (HT64)

The new series of HT professional multimeters is the result of an important research conducted at the most demanding users of this kind of equipment, namely laboratories where the choice of a measuring instrument is subject to strict tests concerning **precision, reliability and safety of measurements even in extreme conditions.**

Therefore, a complete range multimeters, all able to measure in **TRMS**, all within **CAT IV 600V**, **autorange** function available on all models, with backlight display. The design is extremely modern and attractive, but also **ergonomic**, to ensure **maximum ease of use**. **Display with high resolution**, even in **color version**, for the premium model **HT64**. **HT65 stands out among these, unique thanks to its ability to measure DC voltage up to 1500V.**

In the summary table you can find all the features that make this innovative set of professional instruments unique and valuable.

Functions

	HT65	HT64	HT63	HT62	HT61
TRMS Measurements	•	•	•	•	•
Color display	-	•	-	-	-
AC/DC Voltage	•	• AC+DC	•	•	•
AC/DC Current	-	•	•	•	-
AC/DC Current with external transducer	•	•	•	-	-
LoZ voltage measurement	•	•	•	•	•
Resistance/Continuity Test	•	•	•	•	•
Frequency	•	•	•	•	•
Capacitance	•	•	•	•	-
Duty cycle	•	•	•	•	-
Diode test	•	•	•	•	•
Temperature probe type K	•	•	•	•	-
Reading 4-20mA%	-	•	•	-	-
Data HOLD	•	•	•	•	•
MAX/MIN/AVG	-	•	• Max/Min	• Max/Min	• Max/Min
PEAK	-	• 1ms	• 1ms	-	-
Relative Measurement	•	•	•	•	•
Autorange	•	•	•	•	•
Backlight	•	•	•	•	•
Bargraph	-	•	•	•	•
Data loggers and graph	-	•	-	-	-
Internal memory	-	•	-	-	-
Auto Power OFF	•	•	•	•	•

Main features

- Display:**
 - 4 digit LCD, 4000 pixels (**HT65**)
 - 4½ digit LCD, 6000 pixels (**HT61, HT62**)
 - 4½ digit LCD, 60000 pixels (**HT63**)
 - Color 4 4½ digit TFT, 6000 pixels (**HT64**)
- Power supply:**
 - 1x9v battery type 6F22 (**HT65, HT61, HT62**)
 - 4x1.5 V batteries type AAA LR03 (**HT63**)
 - 1x7.4V rechargeable Li-ION battery (**HT64**)
- Auto Power OFF:**
 - after 15 minutes of non-use (**HT65, HT61, HT62, HT63**)
 - 5min ÷ 60 min of non-use (**HT64**)
- Safety:**
 - Measurement category: CAT IV 600V - CAT III 1000V
 - Level of pollution: 2
 - Max operating altitude: 2000m
 - Dimensions (LxWxH): 175x85x55mm
 - Weight (batteries included): about 400 g

Included accessories

- 4324-2 Pair of test leads with 2/4mm tip
- TK101 Type K wire probe
- T10 Type K Probe adapter
- A64 Power supply + adapter (**HT64**)
- Calibration certificate ISO 9000
- Batteries, user manual and transport bag

Technical specifications

	HT65	HT64	HT63	HT62	HT61
DC Voltage					
Reading range:	0.1mV ÷ 1500V	0.1mV ÷ 1000V	0.1mV ÷ 1000V	0.1mV ÷ 1000V	0.1mV ÷ 1000V
Standard accuracy:	±(1.2%reading+4digits)	±(0.1%reading+5digits)	±(0.9%reading+5digits)	±(1.0%reading+2digits)	±(1.0%reading+2digits)
AC Voltage					
Reading range:	1mV ÷ 1000V	0.1mV ÷ 1000V	0.1mV ÷ 1000V	1mV ÷ 1000V	1mV ÷ 1000V
Standard accuracy:	±(1.2%reading+10digits)	±(0.9%reading+5digits)	±(1.0%reading+5digits)	±(1.0%reading+8digits)	±(1.0%reading+8digits)
DC Current					
Reading range:	1A ÷ 1000A (with clamp)	0.1µA ÷ 10A	0.1µA ÷ 10A	0.1µA ÷ 10A	-
Standard accuracy:	±(1.5%reading+6digits)	±(0.9%reading+5digits)	±(1.5%reading+5digits)	±(1.0%reading+3digits)	-
AC Current					
Reading range:	0.30A ÷ 3000A (with clamp)	0.1µA ÷ 10A	0.1µA ÷ 10A	0.1µA ÷ 10A	-
Standard accuracy:	±(2.5%reading+10digits)	±(1.2%reading+5digits)	±(2.5%reading+5digits)	±(1.5%reading+3digits)	-
Resistance and continuity test					
Reading range:	0.1Ω ÷ 40MΩ	0.1Ω ÷ 60MΩ	0.1Ω ÷ 60MΩ	0.1Ω ÷ 60MΩ	0.1Ω ÷ 60MΩ
Standard accuracy:	±(1.0%reading+2digits)	±(0.8%reading+5digits)	±(1.2%reading+5digits)	±(1.0%reading+4digits)	±(1.0%reading+4digits)
Buzzer:	<50Ω	<25Ω	<35Ω	<100Ω	<100Ω
Frequency					
Reading range:	0.001Hz ÷ 10MHz	0.001Hz ÷ 1MHz	0.001Hz ÷ 1MHz	0.001Hz ÷ 1MHz	0.001Hz ÷ 1MHz
Standard accuracy:	±(1.2%reading+3digits)	±(0.09%reading+5digits)	±(1.0%reading+2digits)	±(0.1%reading+1digit)	±(0.1%reading+2digits)
Capacitance					
Reading range:	0.01nF ÷ 40mF	0.01nF ÷ 6mF	0.01nF ÷ 6mF	0.01nF ÷ 1000µF	-
Standard accuracy:	±(3.0%reading+5digits)	±(1.2%reading+8digits)	±(2.5%reading+10digits)	±(3.5%reading+4digits)	-
Duty Cycle					
Reading range:	0.5% ÷ 99.9%	0.1% ÷ 99.9%	20% ÷ 80%	0.1% ÷ 99.9%	0.1% ÷ 99.9%
Standard accuracy:	±(1.2%reading+2digits)	±(1.2%reading+2digits)	±(1.0%reading+5digits)	±(1.2%reading+2digits)	±(1.2%reading+2digits)
Temperature probe type K					
Reading range:	-20°C ÷ 760°C	-40°C ÷ 1350°C	-40°C ÷ 760°C	-45°C ÷ 750°C	-
Standard accuracy:	±(3.0%reading + 5°C)	±(1.0%reading + 3°C)	±(2.0%reading + 3°C)	±(3.5%reading + 5°C)	-



ORDER CODE HRO0JUPI | HRO0NEP

JUPITER NEPTUNE

PROFESSIONAL DEVICES FOR ELECTRIC SAFETY VERIFICATIONS WITH ADVANCED MULTIMETER FUNCTIONS

The new JUPITER and NEPTUNE are innovative devices which, further to being used as powerful multimeters for TRMS measurements, allow performing electric safety tests: RCD, Ra, Loop (JUPITER), Insulation and Continuity (NEPTUNE). They belong to CAT IV 600V, with autorange function available in all models, as well as the backlit display. The design is extremely modern and attractive but, at the same time, ergonomic, to offer the best possible ease of use.



ORDER CODE HRO0MER

MERCURY

PROFESSIONAL MULTIMETER WITH IN-BUILT THERMAL CAMERA

MERCURY is a digital TRMS multimeter which mainly measures AC/DC voltage up to 1000V and AC/DC current up to 10A. Among its important functions, this device features mode AC+DC, which is used to also detect direct components possibly overlapping the alternate signal, and measurement of currents with the use of standard and flexible clamp transducers* (accessory F3000U) directly connected to it. A thermal camera with resolution 80x80pxl is also built in the device in order to allow for a possible simultaneous reading of electric and thermal values of the item to be tested. MERCURY is also provided with a Data Logger function which allows it to perform and save recordings of every parameter which can be measured by the device and graphically display the trend of the values. The device allows saving pictures in BMP format on a micro SD card (provided), and also has a Bluetooth function to connect to mobile devices (tablets/smartphones) through the dedicated APP HTMercury, to create reports to share measured results.

* Standard HT96U and flexible F3000U.

Functions and characteristics

	JUPITER	NEPTUNE
Multimeter section		
DC / AC, AC+DC TRMS voltage	•	•
DC / AC / AC+DC TRMS voltage with low impedance (LoZ)	•	•
AC TRMS current up to 3000A with optional flexible clamp transducer F3000U	•	•
Automatic recognition of AC and DC quantities	•	•
Inrush current (Dynamic INRUSH - DIRC)	•	•
Current/voltage harmonics up to the 25 th and THD% calculation	•	•
Resistance and continuity with buzzer	•	•
Current and voltage frequency	•	•
MAX/MIN/PEAK/HOLD functions	•	•
9999 measuring spots	•	•
Auto-Power-Off function	•	•
Bargraph function	•	•
Funzione bargraph	•	•
Electric verification section		
Overall earth resistance L-PE without RCD tripping	•	-
Loop impedance L-L, L-N and calculation of assumed short-circuit current	•	-
Measurement of tripping time on General RCDs type A and AC (30mA, 100mA, 300mA)	•	-
Measurement of tripping current on General RCDs type A and AC (30mA)	•	-
Phase sequence with 1 terminal	•	•
Insulation with test voltage 50, 100, 250, 500, 1000V with PI and DAR calculation	-	•
Continuity of protective conductors with 200mA	-	•

Included accessories

C2065	Three wire cable Red, Black, Green with Schuko plug (JUPITER)
4324-2	Pair of test tips Red/Black 2/4mm straight banana
YABAT0001HTO	Alkaline battery 1.5V, type AAA, IEC LR03, 4 pcs
YABRS0002HTO	Carrying bag
YAMUM0066HTO	User manual on CD-ROM
YAMUM0065HTO	Quick reference guide
	Calibration certificate ISO9000

Optional accessories

606-IECN	Connector with magnetic terminal
F3000U	AC flexible clamp with 30/300/3000A full scales
HT96U*	AC current clamp with 1/100/1000A full scales
HT97U*	AC current clamp with 10/100/1000A AC full scales
HT98U*	DC current clamp with 1000A full scale
HT4006	AC/DC current clamp with 40/400A full scales
NOCANBA	Hypertac-to-banana adapter
5004-IECR	Red alligator clip
5004-IECN	Black alligator clip

The standard accessories can be different depend on countries.
* Adapter NOCANBA required.

Functions and characteristics

- DC voltage
- AC and AC+DC TRMS voltage
- DC current
- AC and AC+DC TRMS current
- AC and AC+DC TRMS current with standard clamp transducers
- AC TRMS current with flexible clamp transducer F3000U
- "Voltsense" for AC voltage detection without contact
- Resistance and Continuity test
- Diode, Capacitance and Frequency tests
- Temperature with K-type probe
- Infrared temperature with in-built thermal camera
- In-built datalogger
- Data HOLD
- MIN/MAX/PEAK
- Relative measurement
- Bargraph
- Backlight
- Input protective fuses
- Auto Power OFF

Main features

Power supply:	1x7.4V rechargeable Li-ION battery, 1200mAh
Safety:	IEC/EN61010-1
Measurement category:	CAT IV 600V, CAT III 1000V
Insulation:	double insulation
Pollution level:	2
Mechanical protection index:	IP65
Max operating altitude:	2000m
Size (LxWxH):	190x75x55mm
Weight (batteries included):	approx 555g

Included accessories

F3000U	Flexible clamp with full scale 30/300/3000A AC and banana connectors
4324-2	Pair of Red/Black banana connectors with 2/4mm tip
BATMCY	Spare battery Li-ION 7,4V 1500mAh
AOMCY	Multiplug power supply for MERCURY with recharging base
	Micro SD card 8GB,10x
BOMCY	Carrying bag
	Alkaline battery type AAA IEC LR03, 2 pieces (for F3000U)
	Type K bead probe + adapter
	User Manual
	Calibration certificate ISO9000

Optional accessories

HT96U**	Standard clamp with full scale 1/100/1000A AC and Hypertac connector
HT97U**	Standard clamp with full scale 10/100/1000A AC and Hypertac connector
HT98U**	Standard clamp with full scale 1000A DC and Hypertac connector
HT4006	Standard clamp with full scale 40/400A AC/DC and banana connectors

The standard accessories can be different depend on countries.
* Adapter NOCANBA required.



ORDER CODE **HR000005** / **HR000011**

IRONMETER FLASHMETER

TRMS MULTIMETERS WITH BUILT-IN LED TORCH
AND TOTAL AUTORANGE (FLASHMETER)

IRONMETER is the true tester for construction sites, realized with a very **sturdy structure** capable of resisting every shock, ready to rise again after any fall (**even from 3 m high**) and keep working with the very same precision and reliability. It is provided with all of the typical functions of everyday use, but also features an **in-built LED torch** to illuminate poorly lit environments, when necessary. **FLASHMETER**, according to the quantity present at the input, **automatically switches** between voltage and resistance measurement.



ORDER CODE **HR000039**

HT39

TRMS MULTIMETER 4000 DOTS
WITH SERIAL INTERFACE RS-232

HT39 is a **professional TRMS** multimeter which mainly measures **AC/DC voltage** and **AC/DC current in total Autorange**, further to **Peak values**, useful in **industrial verifications**. The device is also provided with **serial interface RS-232** for **PC connection** and **real-time** display of the quantities to be measured. Under these conditions it is possible (through optional dedicated software) to activate and save recordings of the parameters, with programmable sampling period. **HT39** is designed to reach category **CAT III 1000V** and **CAT IV 600V** and is provided with a fuse with high breaking capacity on the current input.

Functions

	IRONMETER	FLASHMETER
TRMS Measurements	•	•
Automatic selection of measurements	-	•
AC/DC Voltage	• (600V)	• (600V)
AC/DC Current	• (10A)	-
Resistance/Continuity Test	•	•
Detection of AC voltage without contact	•	•
Frequency	•	-
Capacitance, Diode test	•	-
Duty cycle	•	-
Built-in flashlight	•	•
Auto HOLD function	-	•
Autorange	•	•
Backlight	•	•
Auto Power OFF	•	•

Main features

Power supply:	2x1.5V batteries type AAA IEC LRO3
Safety:	IEC/EN61010-1
Measurement category:	CAT III 600V
Insulation:	double insulation
Pollution level:	2
Max operating altitude:	2000m
Display:	4 LCD, 4000 dots, decimal sign and point
Protection fuses:	Yes (IRONMETER)
Dimensions (LxWxH):	120x65x45mm (IRONMETER) 140x75x40mm (FLASHMETER)
Weight (batteries included):	200g (IRONMETER) 220g (FLASHMETER)

Included accessories

4324-2	Pair of test leads with tip 2/4mm
	Batteries
	Transport bag
	User Manual

Functions

- TRMS Measurements
- DC Voltage: 1000V
- AC Voltage: 750V
- AC/DC Current: 10A
- Resistance/Continuity Test
- Frequency
- Capacitance and Diode test
- Data HOLD, MAX/MIN/PEAK
- Relative measurement
- RS-232 interface
- Backlight
- Bargraph
- Auto Power OFF

Included accessories

	Pair of test leads
	Batteries
	Protective case with support
	User Manual

Main features

Power supply:	1x9V batteries type 6F22
Safety:	IEC/EN61010-1
Measurement category:	CAT IV 600V, CAT III 1000V
Insulation:	double insulation
Pollution level:	2
Max operating altitude:	2000m
Display:	4 LCD, 4000 dots, decimal sign and point
Protection fuses:	Yes
Dimensions (LxWxH):	164x82x44mm
Weight (batteries included):	400g

Optional accessories

B80	Soft carrying bag
SW39	Windows software + RS-232 cable



TRMS



ORDER CODE **HR000701**

HT701

PROFESSIONAL MULTIMETER
FOR INSULATION MEASUREMENT UP TO 1000V

Professional TRMS multimeter with 10.000 measuring spots and measurement of insulation resistance with selectable test voltage between 50, 100, 250, 500, 1000VDC. HT701 is capable of saving the results of measurements in its internal memory and has been designed in compliance with safety standard IEC/EN61010-1 in CAT III 1000V and CAT IV 600V with double protective insulation.



PR701
Remote switch
probe for insulation
measurements



TRMS



ORDER CODE **HR000401**

HT401

PROFESSIONAL MULTIMETER FOR AC+DC
TRMS MEASUREMENT AND LoZ INPUT

Professional digital multimeter in TRMS with 6000 measuring spots which mainly carries out measurements of AC/DC voltage and AC/DC current. Among the many functions of the device there are the AC+DC mode, used to consider also continuous components possibly overlapping the alternate signal and AC voltage measurements in conditions of low impedance (LoZ) in order to reduce the influences when measuring between adjacent conductors.

Functions

- DC/AC TRMS voltage
- DC/AC TRMS current
- Insulation with test voltage up to 1000VDC
- Resistance and Continuity test
- Frequency
- Diode test
- Capacitance
- Temperature with K-type probe
- Internal memory for measured data saving
- Data HOLD, MAX/MIN, Relative measurement
- Automatic/Manual Range
- Backlight, Bargraph
- Auto Power OFF

Main features

Display:	LCD, 10000 dots
Power supply:	4x1.5V alkaline batteries type AA LR6
Auto Power OFF:	after 20 minutes' idling
Safety:	IEC/EN61010-1, IEC/EN61557-1-2
Measurement category:	CAT III 1000V, CAT IV 600V
Insulation:	double insulation
Pollution level:	2
Max height:	2000mm
Size (LxWxH):	207x95x52mm
Weight (batteries included):	630g

Included accessories

4413-2	Pair of test leads
YAAMK0001HTO	Pair of alligator clips
PR701	Probe for insulation measurement
TK101	K-type wire probe
T10	Adapter for K-type probes
	Belt with magnetic terminal
	Protective case, battery and user manual

Technical Specifications

- DC voltage**
- Measuring range: 0.01mV ÷ 1000V
 - Resolution: 0.01mV ÷ 0.1V
 - Basic accuracy: ±(0.08%reading + 2 digits)
 - Protection: 1000V DC/ACrms
- AC TRMS voltage**
- Measuring range: 0.01mV ÷ 1000V
 - Resolution: 0.01mV ÷ 0.1V
 - Basic accuracy: ±(0.9%reading + 3 digits)
 - Protection: 1000V DC/ACrms
- DC current**
- Measuring range: 0.01mA ÷ 400mA
 - Resolution: 0.01mA ÷ 0.1A
 - Basic accuracy: ±(0.2%reading + 2 digits)
 - Protection: Fuse F440mA/1000V
- AC TRMS current**
- Measuring range: 0.01mA ÷ 400mA
 - Resolution: 0.01mA ÷ 0.1mA
 - Basic accuracy: ±(1.5%reading + 2 digits)
 - Protection: Fuse F440mA/1000V
- Resistance and Continuity test**
- Measuring range: 0.1Ω ÷ 40MΩ
 - Resolution: 0.1Ω ÷ 0.01MΩ
 - Basic accuracy: ±(0.5%reading + 2 digits)
 - Continuity test: <30Ω
 - Protection: 1000V DC/ACrms
- Frequency**
- Measuring range: 0.01Hz ÷ 100kHz
 - Resolution: 0.01Hz ÷ 0.01kHz
 - Basic accuracy: ±(0.1%reading + 5 digits)
 - Protection: 1000V DC/ACrms
- Capacitance**
- Measuring range: 0.001μF ÷ 40mF
 - Resolution: 0.001μF ÷ 0.01mF
 - Basic accuracy: ±(1.2%reading + 2 digits)
 - Protection: 1000V DC/ACrms
- Temperature with K-type probe**
- Measuring range: -200°C ÷ 1200°C
 - Resolution: 0.1°C
 - Basic accuracy: ±(1.0%reading + 1°C)
 - Protection: 1000V DC/ACrms
- Insulation measurement**
- Test voltage: 50, 100, 250, 500, 1000VDC
 - Measuring range: 2MΩ ÷ 22GΩ
 - Resolution: 0.001MΩ ÷ 0.1GΩ
 - Basic accuracy: ±(1.5%reading + 5 digits)
 - Protection: 600V DC/ACrms

Functions

- DC/AC TRMS voltage
- DC/AC TRMS current
- AC+DC measurements
- AC voltage measurement with low impedance "LoZ"
- "VoltSense" for AC voltage detection without contact
- Resistance and Continuity test
- Frequency
- Diode test
- Capacitance
- Temperature with K-type probe
- Data HOLD, MAX/MIN/PEAK
- Relative measurement
- Automatic/Manual Range
- Backlight, Bargraph
- Auto Power OFF

Main features

Display:	LCD, 4 digits, 6000 dots
Power supply:	1x9V alkaline battery type 6F22
Battery life:	150 hours
Auto Power OFF:	after 20 minutes' idling
Safety:	IEC/EN61010-1
Measurement category:	CAT III 1000V, CAT IV 600V
Insulation:	Double insulation
Pollution level:	2
Max height:	2000mm
Size (LxWxH):	190x94x48mm
Weight (batteries included):	460g

Included accessories

4413-2	Pair of test leads
TK101	K-type wire probe
T10	Adapter for K-type probes
	Protective case, battery and user manual

Technical Specifications

- DC voltage**
- Measuring range: 0.01mV ÷ 1000V
 - Resolution: 0.01mV ÷ 0.1V
 - Basic accuracy: ±(0.08%reading + 2 digits)
 - Protection: 1000V DC/ACrms
- AC TRMS voltage**
- Measuring range: 0.01mV ÷ 1000V
 - Resolution: 0.01mV ÷ 0.1V
 - Basic accuracy: ±(0.8%reading + 5 digits)
 - Protection: 1000V DC/ACrms
- DC current**
- Measuring range: 0.01mA ÷ 10A
 - Resolution: 0.01mA ÷ 0.01A
 - Basic accuracy: ±(0.8%reading + 3 digits)
 - Protection: Fuse F440mA/1000V - Fuse F11A/1000V
- AC TRMS current**
- Measuring range: 0.01mA ÷ 10A
 - Resolution: 0.01mA ÷ 10A
 - Basic accuracy: ±(1.2%reading + 3 digits)
 - Protection: Fuse F440mA/1000V - Fuse F11A/1000V
- Resistance and Continuity test**
- Measuring range: 0.1Ω ÷ 40MΩ
 - Resolution: 0.1Ω ÷ 0.01MΩ
 - Basic accuracy: ±(0.8%reading + 2 digits)
 - Continuity test: <30Ω
 - Protection: 1000V DC/ACrms
- Frequency**
- Measuring range: 0.01Hz ÷ 100kHz
 - Resolution: 0.01Hz ÷ 0.01kHz
 - Basic accuracy: ±(0.1%reading + 2 digits)
 - Protection: 1000V DC/ACrms
- Capacitance**
- Measuring range: 0.001μF ÷ 10mF
 - Resolution: 0.001μF ÷ 0.01mF
 - Basic accuracy: ±(1.2%reading + 2 digits)
 - Protection: 1000V DC/ACrms
- Temperature with K-type probe**
- Measuring range: -40°C ÷ 400°C
 - Resolution: 0.1°C
 - Basic accuracy: ±(1.0%reading + 10 digits)
 - Protection: 1000V DC/ACrms



ORDER CODE **HR000712**

HT712

DIGITAL MULTIMETER WITH MEASUREMENT OF VOLTAGE AND PHASE SEQUENCE WITH 1 LEAD

HT712 has been designed to practically and functionally perform the basic functions of a common digital tester in an extremely easy and quick way, thanks to its narrow and long structure. The device measures **AC/DC voltage**, **Frequency**, **Resistance**, and performs **Continuity tests**. Thanks to the innovative and patented 1-terminal method, it is possible to measure Voltage and Frequency, while the **Phase sequence** can also be measured directly on the isolating sheaths of the cables



Functions

- TRMS measurement
- DC/AC voltage
- AC voltage with 1 terminal
- Automatic recognition of AC/DC
- Resistance and Continuity test
- Frequency
- Frequency with 1 terminal
- Phase sequence with 1 terminal
- Data HOLD
- LED indications OK/FAIL
- Autorange
- Measurement category (@ 600V)
- AutoPowerOFF

Main features

Display:	LCD, 3 1/4 digits, 4000 dots
Power supply:	2x1.5V batteries type AAA
Auto Power OFF:	after 5 minutes' idling
Safety:	IEC/EN 61010-1
Insulation:	double insulation
Pollution level:	2
Size (LxWxH):	250x51x30mm
Weight (batteries included):	150g

Technical Specifications

DC voltage

- Measuring range: 0.5V ÷ 600V
- Resolution: 0.1V
- Basic accuracy: $\pm(0.8\%rdg + 1digit)$

AC voltage with 2 terminals

- Measuring range: 1.5V ÷ 600V
- Resolution: 0.1V
- Basic accuracy: $\pm(1.5\%rdg + 5digits)$

Resist. and Continuity test

- Measuring range: 1Ω ÷ 1500Ω
- Resolution: 1Ω
- Basic accuracy: $\pm(1.0\%rdg + 5digits)$
- Continuity: <100Ω

Frequency with 2 terminals

- Measuring range: 40Hz ÷ 69Hz
- Resolution: 0.1Hz
- Basic accuracy: $\pm(0.5\%rdg + 1digit)$

Phase sequence with 1 terminal

- Measuring range: 100V ÷ 600V
- Resolution: 1V

Included accessories

P711EU	Red measuring lead
P710EU	Black measuring lead
B700	Holster
	ISO9000 calibration certificate
	Batteries and user manual

ORDER CODE HR000211 | HR000021 | HR00025N

HT211 | HT21 | HT25N

COMPACT DIGITAL MULTIMETERS IN CAT III



HT21, HT210 and HT25N are compact digital multimeters capable of carrying out mainly measurements of **AC/DC voltage** up to **600V** and **DC current** up to **10A** (HT25N) with complementary functions of **Resistance**, **Continuity test**, **Diode test** and **9V** and **1.5V** alkaline battery tests. These devices have been designed in compliance with **safety standard IEC/EN61010-1** with double protective insulation in **CAT III 600V**. They are provided with a wide LCD display with backlight and each function can be selected through its relevant switch. A further function of this device is Data HOLD to freeze data on the display and REL for relative measurements. HT210 also offers the possibility of measuring **temperature** with the provided **K-type probe**, but also with the optional TK1x probes.

Functions

	HT211	HT21	HT25N
TRMS	•	-	-
AC / DC voltage	•	•	•
AC / DC current	•	-	• DC
Resistance / Continuity test	•	•	•
Frequency	•	•	-
Capacitance	•	•	-
Diode test	•	•	•
Duty Cycle	•	•	-
Temperature with K-type probe	•	-	-
Battery test 1.5V/9V	-	-	•
Data HOLD	•	•	•
Relative measurement	•	•	-
Backlight	•	•	•
Auto Power OFF	•	•	•

Main features

- Display:** LCD 3½ digits, 2000 dots (**HT25N**)
4 digits LCD display, 4000 dots, decimal sign and point (**HT21**)
3¾ digits LCD display, 4000 dots plus decimal sign and point (**HT211**)
- Power supply:** 1x9V batteries type IEC 6F22 (**HT21, HT25N**)
2x1.5V batteries type AAA IEC LR03 (**HT211**)
- Auto Power OFF:** after 15 minutes' idling (**HT211**)
after 30 minutes' idling (**HT21**)
- Safety:** IEC/EN 61010-1
- Measurement category:** CAT III 600V
- Pollution level:** 2
- Insulation:** double insulation
- Size (LxWxH):** 145x70x60mm
- Weight (batteries included):** 210g (**HT21, HT211**), 255g (**HT25N**)

Included accessories

4324-2	Pair of test leads with tip 2/4mm
	Adapter T10 + K-type wire probe (HT211)
	Soft carrying bag for (HT21, HT211)
	Batteries and user manual

Technical Specifications

	HT21 - HT211	HT25N
DC voltage		
Measuring range:	20mV ÷ 600V	1mV ÷ 600V
Resolution:	0.001V ÷ 1V	0.1mV ÷ 1V
Basic accuracy:	±(1.2%reading + 2digits)	±(1%reading + 3digits)
Protection:	600VDC	200Vrms for scale 200.0mV 600V AC/DC
AC voltage		
Measuring range:	20mV ÷ 600V	1V ÷ 600V
Resolution:	0.001V ÷ 1V	0.1V ÷ 1V
Basic accuracy:	±(1.2%reading + 4digits)	±(1.5%reading + 12digits)
Protection:	600VAC	600VAC
DC current		
Measuring range:	400.0µA ÷ 10A AC/DC (HT211)	2mA ÷ 10A DC
Resolution:	0.1µA ÷ 0.01A (HT211)	1µA ÷ 0.01A
Basic accuracy:	±(1%reading + 3digits) (HT211)	±(1.5%reading + 3digits)
Protection:	Rapid fuse 500mA / 600V Quick fuse 10A / 600V for scale 10A (HT211)	Rapid fuse 200mA / 600V Quick fuse 10A / 600V for scale 10A
Battery test		
Measuring range:	-	1.5 / 9V
Resolution:	-	1.5V=1mV / 9V=10mV
Basic accuracy:	-	±(1.5%reading + 3digits)
Protection:	-	1.5V=100mA / 9V=6mA

	HT21 - HT211	HT25N
Resistance and Continuity test		
Measuring range:	2Ω ÷ 40MΩ	1Ω ÷ 2MΩ
Resolution:	0.1Ω ÷ 0.01MΩ	0.1Ω ÷ 1KΩ
Basic accuracy:	±(1%reading + 2digits)	±(1.2%reading + 4digits)
Continuity test	<150Ω	<60Ω
Protection:	250Vrms	250Vrms < 15sec
Frequency		
Measuring range:	25mHz ÷ 10MHz	-
Resolution:	0.001Hz ÷ 10KHz	-
Basic accuracy:	±(1.2%reading + 3digits)	-
Protection:	250Vrms	-
Capacitance		
Measuring range:	0.2nF ÷ 100µF	-
Resolution:	0.01 nF ÷ 0.1µF	-
Diode test		
Resolution:	1mV	1mA
MAX Open-circuit voltage:	1.5VDC	2.8VDC
Basic accuracy:	±(10%reading + 5digits)	ND
Duty Cycle		
Measuring range:	0.5% ÷ 99%	-
Resolution:	0.1%	-
Basic accuracy:	±(1.2%reading + 2digits)	-
Protection:	250Vrms	-
Temperature with K probe (only HT211)		
Measuring range:	-20°C ÷ 760°C	-
Resolution:	0.1°C ÷ 1°C	-
Basic accuracy:	±(3%reading + 5°C)	-



ORDER CODE **HR00012**

HT12

POCKET DIGITAL MULTIMETER WITH INTEGRATED AC/DC 60A FORK CLAMP METER

HT12 is a **super compact** digital multimeter capable of carrying out measurements of **Voltage up to 600V**, **AC/DC current up to 60A** with **integrated clamp sensor** and complementary functions of **Resistance**, **Continuity test** and **Frequency**. This device has been designed in compliance with **safety standard IEC/EN61010-1** with double protective insulation in **CAT III 300V**, **CAT II 600V**. Further functions are **Data HOLD** to freeze data on the display and the **Auto Power OFF** function after 10 minutes' idling, in order to preserve the internal battery. The device is housed in a **protective case** which is also used to rewind the test leads.



ORDER CODE **HR00014D**

HT14D

POCKET DIGITAL MULTIMETER

HT14D is a **compact** digital multimeter capable of carrying out mainly measurements of **AC/DC voltage up to 500V** and **DC current up to 200mA** with complementary functions of **Resistance**, **Diode test** and **9V alkaline battery test**. This device has been designed in compliance with **safety standard IEC/EN61010-1** with double protective insulation in **CAT III 300V**. HT14D is provided with a wide **LCD display** and each function may be selected through its relevant switch. A further function of this device is **Data HOLD** to freeze data on the display.



Functions

- DC/AC voltage
- AC/DC current integrated clamp sensor
- Resistance and continuity test with buzzer
- Current and voltage frequency
- Data HOLD
- Automatic / manual selection of measuring range
- Auto Power OFF

Main features

Display:	LCD, 3¾ digits, 3400 dots
Power supply:	2x1.5V battery type AAA LR03
Auto Power OFF:	after 10 minutes' idling
Safety:	IEC/EN 61010-1
Measurement category:	CAT III 300V, CAT II 600V
Pollution level:	2
Insulation:	double insulation
Size (LxWxH):	128x87x24mm
Weight (batteries included):	210g

Included accessories

- Anti-shock protection shell
- Integrated measuring leads and clamp meter
- Batteries and user manual

Technical Specifications

DC voltage

- Measuring range: 0mV ÷ 600V
- Resolution: 0.001mV ÷ 0.1V
- Basic accuracy: ±(1.5%reading + 4digits)
- Protection against overcharge: 720VDC/AC for 10 seconds

AC voltage

- Measuring range: 0V ÷ 600V
- Frequency band: 50Hz ÷ 400Hz
- Resolution: 0,001V ÷ 1V
- Basic accuracy: ±(1.5%reading + 5 digits)
- Protection against overcharge: 720VDC/AC for 10 seconds

AC/DC current integrated clamp sensor

- Measuring range: 0A ÷ 60A
- Resolution: 0.1A
- Frequency range: 50Hz ÷ 60Hz
- Basic accuracy: ±(2%reading + 5digits)
- Protection against overcharge: 72A DC/AC for 10 seconds

Resistance and Continuity test

- Measuring range: 0Ω ÷ 34MΩ
- Resolution: 0.1Ω ÷ 0.01MΩ
- Basic accuracy: ±(1%reading + 3digits)
- Protection against overcharge: 720VDC/AC for 10 seconds
- Continuity buzzer: R<30Ω ± 10Ω

Frequency

- Current measuring range: 0Hz ÷ 10kHz
- Voltage measuring range: 0Hz ÷ 300kHz
- Basic accuracy: ±(0.1%reading + 1digit)
- Resolution: 0,001kHz ÷ 0.01MHz
- Protection against current overcharge: 72A DC/AC for 10 seconds
- Protection against voltage overcharge: 720VDC/AC for 10 seconds

Functions

- DC/AC voltage
- DC current
- Resistance and Continuity test
- Diode test
- Battery test 9V
- Data HOLD

Main features

Display:	LCD, 3½ digits, 2000 dots
Power supply:	1x12V batteries type MS21/MN21
Safety:	IEC/EN61010-1
Insulation:	double insulation
Pollution level:	2
Size (LxWxH):	105x50x25mm
Weight (batteries included):	100g

Included accessories

- KIT4000A Measuring leads with tip 2mm
- Batteries and user manual

Technical Specifications

DC voltage

- Measuring range: 200mV ÷ 500V
- Resolution: 0.1mV ÷ 1V
- Basic accuracy: ±(0.5%rdg + 2digits)

AC voltage

- Range: 1V ÷ 500V
- Resolution: 0.1V ÷ 1V
- Basic accuracy: ±(1.2%rdg + 10digits)

Resistance and Continuity test

- Measuring range: 1Ω ÷ 2000Ω
- Resolution: 0.1Ω ÷ 1kΩ
- Basic accuracy: ±(0.8%rdg + 4digits)

DC current

- Measuring range: 2000µA ÷ 200mA
- Resolution: 1µA ÷ 0.1mA
- Basic accuracy: ±(1.2%rdg + 2digits)

ORDER CODE HR000100 | HR000008 | HR000007 | HR000006

HT10 | HT8 | HT7 | HT6

TWO-POLE MULTIFUNCTION TESTERS WITH BUILT-IN LED TORCH



HT10, HT8, HT7 and HT6 are designed to carry out the measurements of a digital tester in a practical, quick and functional way thanks to their narrow and long structure, which allows carrying out measurements in any operating conditions. These devices carry out measurements of **AC/DC voltage** with **polarity indication**, **continuity tests** with buzzer and **phase sequence detection** with LED indications and **Display reading**. In addition HT8 and HT6 carry out diode tests, while HT10 and HT7 carry out measurements of AC voltage with low input impedance. **HT10 performs RCD 30mA testing as well**. All meters are provided with a **white LED torch** for use in poorly lit environments, and **comply with safety requirements of standards IEC/EN61243-3:2014/VDE 0682** ensuring safe and reliable working conditions. The instruments indicate **whether a dangerous voltage is present, even if there is no battery power supply** or a failure of the main circuit. The instruments also comply with **IEC/EN61010-1 and IEC/61010-2-030 in CAT IV 600V, CAT III 690V (HT10 CAT IV 600V, CAT III 1000V)**. Protection class **IP64** (dust and splash-proof) and molded soft rubber grips make HT10, HT8, HT7 and HT6 heavy duty instruments ideal for the **toughest jobs in domestic or industrial applications**.



Use of the integrated LED torch.



Phase detection function through conductive button.



Multimeter function with display and LED indication.



Measurement of phase sequence.

Functions

	HT10	HT8	HT7	HT6
AC/DC Voltage	• (1000V)	• (690V)	• (690V)	• (690V)
AC Voltage with 1 terminal	•	•	•	•
AC Voltage with low impedance input	•	-	•	-
Phase sequence	•	•	•	•
Continuity test with buzzer	•	•	•	•
Resistance measurement	•	-	-	-
Diode test	-	•	-	•
LED indications and sound notifications	•	•	•	•
LCD display	•	•	•	-
Integrated torch	•	•	•	•

Main features

Display:	LCD, 4digits, 6900 dots (HT8) LCD, 3½ digits, 1999 dots (HT7, HT10)
Power supply:	2x1.5V battery type AAA LRO3
Safety:	IEC/EN61010-1, IEC/EN61010-2-030 (HT8), IIEC/EN61243-3:2014
Measurement category:	CAT IV 600V - CAT III 690V (HT7, HT8) CAT IV 600V - CAT III 1000V (HT10)
Pollution level:	2
Insulation:	double insulation
Size (LxWxH):	255x60x35mm (HT6, HT8) 240x78x40mm (HT7) 270x70x30mm (HT10)
Weight (batteries included):	170g (HT6, HT8) 240g (HT7) 290g (HT10)

Technical Specifications

	HT10	HT8	HT7	HT6
DC/AC voltage				
Measuring range:	6V ÷ 1000V	10V ÷ 690V	6V ÷ 690V	12V ÷ 690V
Frequency band:	40Hz ÷ 400Hz	16Hz ÷ 400Hz	50Hz ÷ 60Hz	16Hz ÷ 400Hz
Resolution:	1V	0.1V	1V	1V
Basic accuracy:	±(3%reading + 5digits)	±(3%reading + 5digits)	±(1%rdg+3dgt) (DC) ±(1.5%rdg+5dgt) (AC)	In compliance with EN61243-3
Protection against overcharge:	1000VDC/AC	690VDC/AC	690VDC/AC	690VDC/AC
AC voltage with 1 terminal				
Measuring range:	100V ÷ 1000V	100V ÷ 690V	100V ÷ 690V	100V ÷ 690V
Frequency band:	50Hz ÷ 400Hz	50Hz ÷ 60Hz	50Hz ÷ 60Hz	50Hz ÷ 60Hz
Protection against overcharge:	1000VDC/AC	690VAC	690VAC	690VAC
Phase sequence				
Measuring range:	100V ÷ 1000V	120V ÷ 400V (Phase-Earth)	100V ÷ 690V	120V ÷ 400V (Phase-Earth)
Frequency band:	50Hz ÷ 60Hz	50Hz ÷ 60Hz	50Hz ÷ 60Hz	50Hz ÷ 60Hz
Protection against overcharge:	1000VDC/AC	690VAC	690VAC	690VAC
Continuity test with LED and buzzer				
Measuring range:	0Ω ÷ 400kΩ	0Ω ÷ 500kΩ	0Ω ÷ 200kΩ	0Ω ÷ 500kΩ
Test current:	<5μA	<7μA	<1μA	<7μA

Included accessories

	Protection cap for lead, 2 pieces
	Adapter 4mm for lead, 2 pieces
PR9	Mobile lead (HT6, HT8)
	Batteries and user manual

Optional accessories

PR9	Mobile lead (HT6, HT8)
B71	Carrying bag (HT7)



CLAMP METERS

CLAMP METERS



Power clamps

Who?

- › Technicians and maintenance operators in the industry sector
- › Power Quality Professionals
- › Energy managers
- › Maintenance operator in the photovoltaic field

Where?

- › Transformer cabinets
- › Electric switchboards
- › Electric motors
- › Measurements near inverters
- › Photovoltaic installations

Why?

They carry out the main function of mobile equipment and, in this case, offer the possibility of quickly displaying quantities such as **Power, Cosphi, Harmonics, Inrush Currents (INRUSH)** which are functions generally carried out by proper power analyzers.



AC/DC clamps

Who?

- › Installers and electricians of industrial and domestic electric systems
- › Maintenance operators in the electric sector in general, and in the photovoltaic field

Where?

- › Domestic and industrial electric systems
- › Electric panels
- › Electric motors
- › Photovoltaic installations

Why?

Ordinary and preventive maintenance of distribution (also photovoltaic) systems is mainly based on amperometric absorption; in industrial systems it is good practice to use **TRMS** equipment.



Leakage clamps

Who?

- › Installers and maintenance operators in the domestic and industrial sector
- › Safety verification authorities of domestic and industrial electric systems

Where?

- › Electric panels
- › Electric motors
- › Earthing systems

Why?

A correct mapping of all leakage currents to earth can only be carried out with clamps like HT77C, capable of detecting currents as small as μA , and HT78 which, due to the exceptional size of its jaws, is suitable for tests on very big loads.



MAIN MEASUREMENTS	AC										AC/DC						HARMONICS AND/OR POWER				LEAKAGE		
	HT9019	HT9014	HT9012	HT4011	HT4010	F3000	HT100	HT7004	HT3010	HT3013	ECLIPSE	HT9025	HT9021	HT9015	HT4013	HT7005	HT9023	HT9020	HT4022	HT4020	HT79	HT77C	
TRMS	•	•	-	-	-	•	•	•	•	•	•	•	•	•	-	•	•	•	•	•	•	•	•
Current measuring range	1000A	600A	600A	400A	600A	3000A	200A	300A	400A	400A	1000A	1000A	1000A	600A	400A	400A	1000A	1000A	400A	400A	10A (DC) 20A (AC)	60A	
AC/DC current	• AC	• AC	• AC	• AC	• AC	• AC	• AC	• AC	• AC	•	•	•	•	•	•	•	• AC+DC	• AC+DC	• AC	• AC	•	• AC	
AC/DC voltage	•	•	•	•	•	-	•	-	•	•	•(1500VDC)	•(1500VDC)	•	•	•	-	•(1500VDC)	•	•	•	•	•	
Leakage current	-	-	-	-	-	-	-	-	-	-	• (external transducer)	• (external transducer)	-	-	-	-	-	-	-	-	-	• AC/DC	• AC
Frequency	-	•	-	•	-	-	-	-	•	•	•	•	•	•	•	-	•	•	•	•	•	-	-
Resistance and continuity test with buzzer	•	•	•	•	•	-	•	-	•	•	•	•	•	•	•	-	•	•	•	•	•	•	-
Capacitance	-	•	-	•	-	-	-	-	-	•	•	•	•	•	•	-	-	-	-	-	-	-	-
Diode test	-	•	•	•	•	-	•	-	•	•	•	•	•	•	•	-	-	-	-	-	-	-	-
Duty Cycle (%)	-	•	-	•	-	-	-	-	-	•	•	•	•	•	•	-	-	-	-	-	-	-	-
Temperature with K-type probe	-	•	-	•	-	-	-	-	-	-	•	•	•	•	•	-	-	-	-	-	-	-	-
Phase sequence and phase concordance	-	-	-	-	-	-	-	-	-	-	-	-	-	-	-	-	•	•	•	•	-	-	
Automatic recognition of internal functions	-	-	-	-	-	-	•	-	-	-	-	-	-	-	-	-	-	-	-	-	-	-	
AC/DC Current with external transducers	-	-	-	-	-	-	-	-	-	-	• AC+DC	• AC+DC	-	-	-	-	-	-	-	-	-	-	-
AC Voltage with low impedance (LoZ)	-	-	-	-	-	-	-	-	-	-	•	•	-	-	-	-	-	-	-	-	-	-	-
MAINS ANALYSIS																							
AC/DC voltage, current measurement/recording	-	-	-	-	-	-	-	-	-	-	-	-	-	-	-	-	•	•*	•*	•*	-	-	• Current with HTLeakage APP
AC/DC power measurement/recording	-	-	-	-	-	-	-	-	-	-	-	-	-	-	-	-	•	•*	•*	•*	-	-	-
AC/DC energy measurement/recording	-	-	-	-	-	-	-	-	-	-	-	-	-	-	-	-	•	•*	•*	•*	-	-	-
Cosphi, PF measurement/recording	-	-	-	-	-	-	-	-	-	-	-	-	-	-	-	-	•	•*	•*	•*	-	-	-
UI + THD% harmonics measurement/recording	-	-	-	-	-	-	-	-	-	-	-	-	-	-	-	-	•	•*	•*	-	-	-	-
Inrush current measurement (INRUSH)	-	-	-	-	-	-	-	-	-	-	•	•	-	-	-	•	• Dynamic INRUSH	• Dynamic INRUSH	-	-	-	-	-
ADDITIONAL CHARACTERISTICS																							
Measurement category	CAT IV 600V CAT III 1000V	CAT IV 600V CAT III 1000V	CAT IV 600V CAT III 1000V	CAT III 600V	CAT III 600V	CAT IV 600V CAT III 1000V	CAT IV 600V CAT III 1000V	CAT III 300V	CAT III 600V	CAT III 600V	CAT IV 600V CAT III 1000V	CAT IV 600V CAT III 1000V	CAT IV 600V CAT III 1000V	CAT IV 600V CAT III 1000V	CAT III 600V	CAT III 300V	CAT IV 600V CAT III 1000V	CAT IV 600V CAT III 1000V	CAT III 600V	CAT III 600V	CAT IV 300V	CAT III 600V	
Maximum cable diameter	45mm	30mm	30mm	30mm	30mm	110mm	16mm	20mm	30mm	30mm	40mm	40mm	45mm	30mm	30mm	20mm	45mm	45mm	30mm	30mm	23mm	40mm	
Measuring counts	6000	6000	2000	4000	2000	3000	10000	4000	2000	6000	6000	6000	6000	4000	4000	9999	9999	10000	10000	5000	6000		
Backlight	•	•	•	-	•	•	•	•	•	•	•	•	•	•	-	•	•	•	•	•	•	•	
Bargraph	•	•	-	-	-	-	-	-	-	-	•	•	•	•	-	-	-	-	•	•	-	-	
Autorange	•	•	•	•	•	•	•	•	•	•	•	•	•	•	•	•	•	•	•	•	•	•	
Auto power off	•	•	•	•	•	•	•	•	•	•	•	•	•	•	•	•	•	•	•	•	•	•	
Contactless AC voltage detection	•	•	•	•	•	-	•	•	•	•	•	•	•	•	•	•	•	•	-	-	-	-	
Data HOLD function	•	•	•	•	•	•	•	•	•	•	•	•	•	•	•	•	•	•	•	•	•	•	
MIN/MAX function	•	•	• MAX	-	• MAX	-	-	-	•	•	•	•	•	•	-	-	•	•	•	•	•	•	
AVG function (AVERAGE)	-	-	-	-	-	-	-	-	-	-	-	-	-	-	-	-	-	-	•	•	-	-	
PEAK function	•	•	-	-	-	-	-	-	-	-	•	•	•	•	-	-	•	•	•	•	•	-	
Relative measurement (ZERO)	-	•	-	•	-	-	-	-	-	•	•	•	•	•	-	-	-	-	-	-	•	-	
Low-pass filter for harmonic reduction	-	-	-	-	-	-	-	-	-	-	-	-	-	-	-	-	-	-	-	-	-	•	
Infrared camera	-	-	-	-	-	-	-	-	-	-	•	-	-	-	-	-	-	-	-	-	-	-	
Colour display	-	-	-	-	-	-	-	-	-	-	•	•	-	-	-	-	-	-	-	-	-	-	
Electrical parameter logging	-	-	-	-	-	-	-	-	-	-	•	•	-	-	-	-	•	•	-	-	-	-	
Memory for data saving	-	-	-	-	-	-	-	-	-	-	-	•	-	-	-	-	•	•	-	-	-	-	
PC / Smartphone or Tablet interface	-	-	-	-	-	-	-	-	-	-	•Bluetooth	•Bluetooth	-	-	-	-	-	-	-	-	-	-	•Bluetooth
Power supply	1x 9V 6F22	1x 9V 6F22	1x 9V 6F22	2x 1.5V AAA	1x 9V 6F22	2x 1.5V AAA	2x 1.5V AAA	2x 1.5V AAA	3x 1.5V AAA	3x 1.5V AAA	Li-ION battery	Li-ION battery	1x 9V 6F22	1x 9V 6F22	2x 1.5V AAA	2x 1.5V AAA	2x 1.5V AAA	2x 1.5V AAA	2x 1.5V AAA	2x 1.5V AAA	2x 1.5V AAA	2x 1.5V AA	
Size in mm (L x W x H)	252x88x44	215x74x43	215x74x43	200x66x37	197x70x40	280x120x25	193x54x31	160x55x30	220x81x42	220x81x42	280x100x50	280x100x50	252x88x44	215x74x43	200x66x37	160x55x30	252x88x44	252x88x44	205x64x39	205x64x39	206x76x34	230x100x24	
Weight in grams (batteries included)	402	285	285	205	180	170	280	140	320	320	505	505	442	285	205	140	420	420	280	280	262	500	
Reference standard for safety	IEC/ EN61010-1	IEC/ EN61010-1	IEC/ EN61010-1	IEC/ EN61010-1	IEC/ EN61010-1	IEC/ EN61010-1	IEC/ EN61010-1	IEC/ EN61010-1	IEC/ EN61010-1	IEC/ EN61010-1	IEC/ EN61010-1	IEC/ EN61010-1	IEC/ EN61010-1	IEC/ EN61010-1	IEC/ EN61010-1	IEC/ EN61010-1	IEC/ EN61010-1	IEC/ EN61010-1	IEC/ EN61010-1	IEC/ EN61010-1	IEC/ EN61010-1	IEC/ EN61010-1	EN61010-1 EN61557-13-16
Order code	HP009019	HP009014	HP009012	HP004011	HP004010	HP030000	HP000100	HP007004	HP003010	HP003013	HP000ECL	HP009025	HP009021	HP009015	HP004013	HP007005	HP009023	HP009020	HP004022	HP004020	HP000079	HP00077C	



ORDER CODE HP003010 | HP003013

HT3010 HT3013

TRMS 400A CLAMP METERS WITH AC VOLTAGE DETECTOR WITHOUT CONTACT

The professional clamp meters HT3010 and HT3013 perform TRMS measurements of AC current up to 400A (HT3010), AC/DC current up to 400A (HT3013), AC/DC voltage up to 600V, Frequency, Resistance, Continuity tests, Diode tests, and measurements of Capacitance (HT3013), Temperature with K-type probe (HT3013) and Duty Cycle (HT3013). Each instrument complies with standard IEC/EN61010-1 in CAT III 600V and is provided with display backlight and auto power off function in order to spare the charge of the internal batteries.



Functions

	HT3010	HT3013
TRMS measurements	•	•
DC/AC voltage	•	•
AC current	•	•
DC current	-	•
Frequency with test leads and clamp jaws	•	•
Duty cycle (%)	-	•
Resistance / Continuity test	•	•
Diode test	•	•
Capacitance	-	•
Temperature with K-type probe	-	•
Data HOLD	•	•
MAX/MIN	•	•
Relative measurement (ZERO)	-	•
Autorange	•	•
Backlight	•	•
Auto Power OFF	•	•

Main features

Display:	LCD 4 digits, 6000 dots (HT3013) LCD 3 1/2 digits, 2000 dots (HT3010)
Conversion type:	TRMS
Power supply:	3x1.5V batteries type AAA LR03
Auto Power OFF:	after 15 minutes' idling
Safety:	IEC/EN 61010-1
Measurement category:	CAT III 600V
Pollution level:	2
Insulation:	double insulation
Max height:	2000m
Jaw internal diameter:	30mm
Weight (batteries included):	320g
Size (LxWxH):	220x81x42mm
Weight (batteries included):	approx 280g

Provided accessories

KIT4000A	Pair of test leads
TK101	K-type wire probe (HT3013)
T10	Adapter for K-type probe (HT3013)
	Carrying bag
	Batteries
	User Manual



ORDER CODE **HP000ECL**

ECLIPSE

AC/DC TRMS 1000A CAT IV CLAMP METER WITH INFRARED TEMPERATURE MEASUREMENT AND MEASUREMENT OF DC VOLTAGE UP TO 1500V

ECLIPSE has been designed to measure **AC/DC current up to 1000A**, **DC voltage up to 1500V** and AC voltage up to 1000V in **TRMS** reaching **CAT IV 600V** and **CAT III 1000V** in compliance with safety standard **IEC/EN61010-1**. The clamp is provided with a display with **6000 measuring spots** with **backlight** and **bargraph** to allow for a simple reading even in poorly lit environments. ECLIPSE also measures **Resistance**, **Frequency**, **Capacitance** and **Temperature with K-type probe** and infrared temperature with built-in thermal camera. The Bluetooth connection allows for the transfer of the saved snapshots by means of the dedicated App HTMercury.



ORDER CODE **HP009025**

HT9025

AC/DC TRMS 1000A CAT IV CLAMP METER WITH MEASUREMENT OF DC VOLTAGE UP TO 1500V

HT9025 has been designed to measure **AC/DC current up to 1000A**, **DC voltage up to 1500V** and AC voltage up to 1000V in **TRMS** reaching **CAT IV 600V** and **CAT III 1000V** in compliance with safety standard **IEC/EN61010-1**. The clamp is provided with a display with **6000 measuring spots** with **backlight** and **bargraph** to allow for a simple reading even in poorly lit environments. HT9025 also measures **Resistance**, **Frequency**, **Capacitance** and **Temperature with K-type probe**. The Bluetooth connection allows for the transfer of the saved snapshots by means of the dedicated App HTMercury.

Functions

- TRMS measurements
- DC voltage up to 1500V
- AC voltage up to 1000V
- AC+DC voltage
- AC voltage with low impedance (LoZ)
- DC/AC current up to 1000A
- Inrush current (INRUSH)
- DC/AC current with external clamp transducers
- Resistance and Continuity test
- "Volsense" for AC voltage detection
- Frequency with clamp jaws and leads
- Capacitance / Duty cycle / Diode test
- Temperature with K-type probe
- Built-in infrared thermal camera (80x80pxl)
- Autorange / Data HOLD / MAX/MIN / PEAK (<1ms)
- Relative measurements
- DataLogger function
- Backlight and Bargraph
- Auto Power OFF

Main features

Display:	colour TFT 6000 dots
Conversion type:	TRMS
Power supply:	1x7.4V rechargeable Li-ION battery, after 15÷60 minutes' idling
Auto Power OFF:	40mm
Clamp jaw internal diameter:	max 128 snapshots/16 recordings
Internal memory:	BLE 4.0
Bluetooth connection	IEC/EN61010-1
Safety:	CAT IV 600V - CAT III 1000V
Measurement category:	double insulation
Insulation:	2
Pollution level:	280x100x50mm
Size (LxWxH):	505g
Weight (batteries included):	



Basic technical specifications

DC voltage

- Measuring range: 1mV ÷ 1500V
- Resolution: 0.1mV ÷ 1V
- Basic accuracy: ±(0.5%reading + 5digits)
- Protection against overcharge: 1500VDC

AC TRMS voltage

- Measuring range: 1mV ÷ 1000V
- Frequency bandwidth: 50Hz ÷ 1kHz
- Resolution: 0,001V ÷ 1V
- Basic accuracy: ±(1.2%reading + 5digits)
- Protection against overcharge: 1000VDC/ACrms

DC current

- Measuring range: 0.3A ÷ 1000A
- Resolution: 0.01A ÷ 1A
- Basic accuracy: ±(2.0%reading + 8digits)
- Protection against overcharge: 1000Arms

AC TRMS current

- Measuring range: 0.3A ÷ 1000A
- Frequency bandwidth: 50Hz ÷ 60Hz
- Resolution: 0.01A ÷ 1A
- Basic accuracy: ±(2.5%reading+5digits)
- Protection against overcharge: 1000Arms

Resistance and Continuity test

- Measuring range: 0.1Ω ÷ 60MΩ
- Resolution: 0.1Ω ÷ 0.01MΩ
- Basic accuracy: ±(0.8%reading + 5digits)
- Continuity buzzer: <50Ω



Accessories provided

4324-2	Pair of leads with 2/4mm tip
T10	Adapter for K-type wire probe
TK101	K-type wire probe
BAT64	Li-ION rechargeable battery, 2 pieces
A0EC95	Battery charger power supply + recharging base
B0EC95	Carrying bag
	User manual, ISO9000 calibration certificate

Functions

- TRMS measurements
- DC voltage up to 1500V
- AC voltage up to 1000V
- AC+DC voltage
- AC voltage with low impedance (LoZ)
- DC/AC current up to 1000A
- Inrush current (INRUSH)
- DC/AC current with external clamp transducers
- Resistance and Continuity test
- "Volsense" for AC voltage detection
- Frequency with clamp jaws and leads
- Capacitance / Duty cycle / Diode test
- Temperature with K-type probe
- Autorange / Data HOLD / MAX/MIN / PEAK (<1ms)
- Relative measurements
- DataLogger function
- Backlight and Bargraph
- Auto Power OFF

Main features

Display:	colour TFT 6000 dots
Conversion type:	TRMS
Power supply:	1x7.4V rechargeable Li-ION battery, after 15÷60 minutes' idling
Auto Power OFF:	40mm
Clamp jaw internal diameter:	max 128 snapshots/16 recordings
Internal memory:	BLE 4.0
Bluetooth connection	IEC/EN61010-1
Safety:	CAT IV 600V - CAT III 1000V
Measurement category:	double insulation
Insulation:	2
Pollution level:	280x100x50mm
Size (LxWxH):	505g
Weight (batteries included):	



Basic technical specifications

DC voltage

- Measuring range: 1mV ÷ 1500V
- Resolution: 0.1mV ÷ 1V
- Basic accuracy: ±(0.5%reading + 5digits)
- Protection against overcharge: 1500VDC

AC TRMS voltage

- Measuring range: 1mV ÷ 1000V
- Frequency bandwidth: 50Hz ÷ 1kHz
- Resolution: 0,001V ÷ 1V
- Basic accuracy: ±(1.2%reading + 5digits)
- Protection against overcharge: 1000VDC/ACrms

DC current

- Measuring range: 0.3A ÷ 1000A
- Resolution: 0.01A ÷ 1A
- Basic accuracy: ±(2.0%reading + 8digits)
- Protection against overcharge: 1000Arms

AC TRMS current

- Measuring range: 0.3A ÷ 1000A
- Frequency bandwidth: 50Hz ÷ 60Hz
- Resolution: 0.01A ÷ 1A
- Basic accuracy: ±(2.5%reading+5digits)
- Protection against overcharge: 1000Arms

Resistance and Continuity test

- Measuring range: 0.1Ω ÷ 60MΩ
- Resolution: 0.1Ω ÷ 0.01MΩ
- Basic accuracy: ±(0.8%reading + 5digits)
- Continuity buzzer: <50Ω



Accessories provided

4324-2	Pair of leads with 2/4mm tip
T10	Adapter for K-type wire probe
TK101	K-type wire probe
BAT64	Rechargeable Li-ION battery
A0EC95	Battery charger power supply + recharging base
B0EC95	Carrying bag
	User manual, ISO9000 calibration certificate

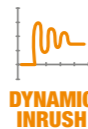

ORDER CODE **HP009023**

HT9023

PROFESSIONAL CLAMP METER FOR MEASURING POWER/HARMONICS WITH WIFI CONNECTION

HT9023 has been designed to measure AC, DC AC+DC current up to 1000A in TRMS reaching CAT IV 600V and CAT III 1000V in compliance with safety standard IEC/EN61010-1. The clamp also measures DC voltage up to 1500V, AC, AC+DC voltage up to 1000V, Active, Reactive and Apparent Power, Power Factor, Energy, voltage/current harmonic analysis up to the 25th with THD% calculation in balanced single-phase or three-phase systems. It is also possible to carry out the phase sequence test with 1-terminal. The instrument also detects the events linked to motor starting currents (Dynamic INRUSH) and allows recording each measured electric parameter over time, with the possibility of transferring data via WiFi to Android/iOS devices through the HTAnalysis App or onto PC through the TOPVIEW software. The clamp is provided with a wide graphic dot-matrix screen (128x128pxl) with backlight, in order to allow reading data even in poorly lit environments, and it is provided with an auto power off function to preserve its internal battery.



ORDER CODE **HP009021**

HT9021

AC/DC TRMS CAT IV 600V CLAMP METER WITH TEMPERATURE MEASUREMENT

HT9021 has been designed to measure AC/DC current up to 1000A in TRMS reaching CAT IV 600V and CAT III 1000V in compliance with safety standard IEC/EN61010-1. The clamp is provided with a display with 6000 measuring spots with backlight and bargraph to allow for a simple reading even in poorly lit environments. HT9021 also carries out measurements of voltage up to 1000V, Resistance, Frequency, Capacitance and Temperature with K-type probe.

Functions

- DC, AC + DC TRMS current up to 1000A
- DC voltage up to 1500V
- AC, AC+DC TRMS voltage up to 1000V
- Resistance and Continuity test
- "Voltsense" for AC voltage detection
- Frequency with clamp jaws and leads
- Phase sequence / phase concordance with 1 terminal
- Measurement/recording of DC power and energy
- Active, reactive, apparent power meas./rec. in single-phase system
- Active, reactive power meas./rec. in single-phase systems
- Power factor measurement/recording in single-phase systems
- Measurement/Recording of voltage/current harmonics up to the 25th and calculation of THD%
- Motor starting current detection (Dynamic INRUSH)
- Data logger function with programmable PI
- Autorange
- Data HOLD
- MAX/MIN/AVG
- PEAK (1ms)
- ZERO
- Backlight
- WiFi for connection to PC and Android/iOS devices
- Auto Power OFF

Main features

Display:	dot-matrix 128x128pxl with backlight
Conversion type:	TRMS
Power supply:	2x1.5V batteries type AAA LR03
Duration:	> 40ore
Internal memory:	2MBytes (ca. 5g @IP=1min)
PC interface:	WiFi
Clamp jaw internal diameter:	45mm
Safety:	IEC/EN61010-1
Measurement category:	CAT IV 600V - CAT III 1000V
Insulation:	double insulation
Pollution level:	2
Size (LxWxH):	252x88x44mm
Weight (batteries included):	420g

Accessories provided

YAAMK0000HT0	Pair of test leads
YAAMK0001HT0	Pair of alligator clips
TOPVIEWS	Windows software for PC connection
YABRS0000NNO	Carrying bag
	Batteries
	ISO9000 calibration certificate
	User manual on CD-ROM
	Quick user guide

Functions

- TRMS measurements
- AC/DC voltage up to 1000V
- AC/DC current up to 1000A
- Resistance and Continuity test
- "Voltsense" for AC voltage recognition
- Frequency with clamp jaws and leads
- Capacitance, Duty cycle, Diode test
- Temperature with K-type probe
- Autorange, Data HOLD
- MAX/MIN, PEAK (<10ms)
- Relative measurements
- Backlight, Bargraph
- Auto Power OFF

Main features

Display:	LCD, 4 digits, 6000 dots
Conversion type:	TRMS
Power supply:	1x9V battery type IEC6F22
Auto Power OFF:	after 15 minutes' idling
Max diameter of clamp:	45mm
Safety:	IEC/EN61010-1
Measurement category:	CAT IV 600V – CAT III 1000V
Insulation:	double insulation
Pollution level:	2
Size (LxWxH):	252x88x42mm
Weight (batteries included):	420g

Technical Specifications

- DC voltage (Autorange)**
 - Measuring range: 3mV ÷ 1000V
 - Basic accuracy: ±(1.0%reading + 3digits)
- AC TRMS voltage (Autorange)**
 - Measuring range: 0.03V ÷ 1000V
 - Frequency range: 50Hz ÷ 400Hz
 - Basic accuracy: ±(1.0%reading + 4digits)
- DC current**
 - Measuring range: 0.3A ÷ 1000A
 - Basic accuracy: ±(2.0%reading + 8digits)
- AC TRMS current**
 - Measuring range: 0.3A ÷ 1000A
 - Frequency range: 50Hz ÷ 400Hz
 - Basic accuracy: ±(2.8%reading + 8digits)
- Resistance and Continuity test**
 - Measuring range: 3Ω ÷ 60MΩ
 - Basic accuracy: ±(1.0%reading + 5 digits)
 - Buzzer: <50Ω
- Frequency with clamp jaws and leads**
 - Measuring range: 0.5Hz ÷ 60kHz
 - Basic accuracy: ±(1.0%reading + 5digits)
- Capacitance**
 - Measuring range: 0.2nF ÷ 4mF
 - Basic accuracy: ±(2.5%reading + 5digits)
- Temperature with K-type probe**
 - Measuring range: -20°C ÷ 760°C;
 - Basic accuracy: ±(2.0%reading + 3°C)

Included accessories

4324-2	Pair of test leads with 2/4 mm tip
T10	Adapter for K-type wire probe
TK101	K-type wire probe
YABRS0000NNO	Soft carrying bag
	Batteries and user manual



CAT III 1000V



DYNAMIC INRUSH



ORDER CODE **HP009020**

HT9020

PROFESSIONAL CLAMP METERS WITH POWER/HARMONIC AND INRUSH MEASUREMENT

HT9020 have been designed for measuring DC, AC+DC TRMS current up to 1000A to obtain CAT IV 600V in compliance with standard IEC/EN61010-1. It also measures **Active, Reactive and Apparent Power, Energy, voltage/current harmonic analysis up to the 25th with THD% calculation** in single-phase or balanced three-phase systems. It allows testing phase sequence and concordance with the 1-terminal measuring method. It is also possible to detect the events linked to **motor starting (INRUSH) currents**. HT9020 is provided with a wide graphic dot-matrix screen (128x128pxl) with backlight, in order to allow reading data even in poorly lit environments. Auto power off function preserves internal battery.



CAT III 1000V



ORDER CODE **HP009019**

HT9019

PROFESSIONAL CLAMP METERS AC 1000A TRMS, CAT IV 600V

Professional clamp meter HT9019 has been designed to measure **AC current up to 1000A and AC/DC voltage up to 1000V in TRMS** to reach **CAT IV 600V** according to standard IEC/EN61010-1. The clamp is provided with a wide display with **6000 measuring spots, backlight** and analogue **bargraph** to allow for a simple reading even in poorly lit environments. Clamp HT9019 is also provided with the auto power off function to preserve its own battery.

Functions

- DC, AC + DC TRMS current up to 1000A
- DC, AC + DC TRMS voltage up to 1000V
- Frequency with test leads and clamp jaws
- Phase sequence / phase concordance
- Resistance and Continuity test
- Measurement of DC power and energy
- Active, reactive, apparent power measurement on single-phase systems
- Power factor measurement on single-phase systems
- Voltage/current harmonic measurement up to the 25th and THD%
- Motor starting (INRUSH) current detection
- Autorange
- Backlight
- Auto Power OFF
- Data HOLD, MAX/MIN/CREST

Main features

- Display:** dot-matrix 128x128pxl with backlight
- Power supply:** 2x1.5V batteries type AAA
- Duration:** > 150 hours
- Safety:** IEC/EN61010-1
- Insulation:** Double insulation
- Pollution level:** 2
- Measurement category:** CAT IV 600V to earth, max 1000V between inputs
- Max diameter of cable:** 45mm
- Size (LxWxH):** 252x88x44mm
- Weight (batteries included):** 0.42kg

Included accessories

YAAMK0000HT0	Pair of test leads
YAAMK0001HT0	Pair of alligator clips
YABRS0000NNO	Soft carrying bag
	Batteries
	User manual on CD-ROM
	ISO9000 calibration certificate
	Quick user guide

Functions

- TRMS measurements
- AC current up to 1000A
- AC/DC voltage up to 1000V
- Resistance and Continuity test
- "Voltsense" for AC voltage detection
- Autorange
- Data HOLD
- MAX/MIN
- PEAK CURRENT (<10ms)
- Bargraph
- Backlight
- AutoPowerOFF

Main features

- Display:** LCD, 4 digits, 6000 dots
- Conversion type:** TRMS
- Power supply:** 1x9V batteries type IEC 6F22
- Auto Power OFF:** after 15 minutes' idling
- Clamp jaw internal diameter:** 45mm
- Safety:** IEC/EN61010-1
- Measurement category:** CAT IV 600V - CAT III 1000V
- Insulation:** double insulation
- Pollution level:** 2
- Size (LxWxH):** 252x88x44mm
- Weight (batteries included):** 420g

Technical Specifications

- DC voltage (Autorange)**
 - Measuring range: 3mV ÷ 1000V
 - Resolution: 0.01mV ÷ 1V
 - Basic accuracy: ±(1.0%reading + 3digits)
 - Protection against overcharge: 1000VDC/ACrms
- AC TRMS voltage (Autorange)**
 - Measuring range: 0.03V ÷ 1000V
 - Frequency band: 50Hz ÷ 400Hz
 - Resolution: 0.001V ÷ 1V
 - Basic accuracy: ±(1.0%reading + 4digits)
 - Protection against overcharge: 1000VDC/ACrms
- AC TRMS current**
 - Measuring range: 0.3A ÷ 1000A
 - Frequency band: 50Hz ÷ 400Hz
 - Resolution: 0.01A ÷ 1A
 - Basic accuracy: ±(2.8%reading + 8digits)
 - Protection against overcharge: 1000Arms
- Resistance and Continuity test**
 - Measuring range: 3Ω ÷ 60MΩ
 - Resolution: 0.1Ω ÷ 0.01MΩ
 - Basic accuracy: ±(1.0%reading + 5digits)
 - Continuity buzzer: <50Ω

Included accessories

4324-2	Pair of test leads with 2/4 mm tip
YABRS0000NNO	Soft carrying bag
	Batteries and user manual



ORDER CODE **HP009015**

HT9015

AC/DC TRMS 600A CAT IV CLAMP METER WITH TEMPERATURE MEASUREMENT

HT9015 has been designed to measure **AC/DC current up to 600A** and **AC/DC voltage up to 1000V** in TRMS reaching **CAT IV 600V** and **CAT III 1000V** in compliance with **safety standard IEC/EN61010-1**. The clamp is provided with a display with **6000 measuring spots** with **backlight** and **bargraph** to allow for a simple reading even in poorly lit environments. HT9015 also measures **Resistance, Frequency, Capacitance** and **Temperature** with K-type probe.



ORDER CODE **HP009014**

HT9014

PROFESSIONAL CLAMP METER AC 600A TRMS, CAT IV 600V

Professional clamp meter HT9014 has been designed to measure **AC current up to 600A** and **AC/DC voltage up to 1000V TRMS** to reach **CAT IV 600V** and **CAT III 1000V** in compliance with standard **IEC/EN61010-1**. The clamp is provided with a wide **backlight display** with **6000 measuring spots** and an auto power off function to preserve its battery.



Functions

- TRMS measurements
- AC/DC voltage up to 1000V
- AC/DC current up to 600A
- Resistance and Continuity test
- "Voltsense" for AC voltage recognition
- Frequency with clamp jaws and leads
- Capacitance
- Duty cycle
- Diode test
- Temperature with K-type probe
- Autorange
- Data HOLD
- MAX/MIN
- PEAK (<10ms)
- Relative measurements
- Backlight and Bargraph
- Auto Power OFF

Main features

Display: LCD, 4 digits, 6000 dots
Conversion type: TRMS
Power supply: 1x9V battery type IEC6F22
Auto Power OFF: after 15 minutes' idling
Max diameter of clamp: 30mm
Safety: IEC/EN61010-1
Measurement category: CAT IV 600V - CAT III 1000V
Insulation: double insulation
Pollution level: 2
Size (LxWxH): 210x75x45mm
Weight (batteries included): 400g



Technical Specifications

DC voltage (Autorange)

- Measuring range: 3mV ÷ 1000V
- Basic accuracy: ±(1.0%reading + 3digits)

AC TRMS voltage (Autorange)

- Measuring range: 0.03V ÷ 1000V
- Frequency range: 50Hz ÷ 400Hz
- Basic accuracy: ±(1.0%reading + 4digits)

DC current

- Measuring range: 0.3A ÷ 600A
- Basic accuracy: ±(2.0%reading + 8digits)

AC TRMS current

- Measuring range: 0.3A ÷ 600A
- Frequency range: 50Hz ÷ 400Hz
- Basic accuracy: ±(2.8%reading + 8digits)

Resistance and Continuity test

- Measuring range: 3Ω ÷ 60MΩ
- Basic accuracy: ±(1.0%reading + 5 digits)
- Buzzer: <50Ω

Frequency with clamp jaws and leads

- Measuring range: 0.5Hz ÷ 60kHz
- Basic accuracy: ±(1.0%reading + 5digits)

Capacitance

- Measuring range: 0.2nF ÷ 4mF
- Basic accuracy: ±(2.5%reading + 5digits)

Temperature with K-type probe

- Measuring range: -20°C ÷ 760°C; -4°F ÷ 1400°F
- Basic accuracy: ±(2.0%reading + 6°F)



Included accessories

4324-2	Pair of test leads with 2/4 mm tip
T10	Adapter for K-type wire probe
TK101	K-type wire probe
	Battery, User manual and Soft carrying bag

Functions

- Measurements in TRMS, DC/AC voltage, AC current
- Resistance / Continuity test, Frequency
- "Voltsense" sensor
- Diode test, Temperature with K-type probe
- Capacitance, Duty Cycle
- Autorange, Data HOLD, MAX/MIN
- PEAK CURRENT (<10ms)
- Relative measurement, Bargraph, Backlight, AutoPowerOFF



Main features

Display: LCD, 4 digits, 6000 dots
Conversion type: TRMS
Power supply: 1x9V battery type IEC 622
Auto Power OFF: after 30 minutes' idling
Clamp jaw internal diameter: 30mm
Safety: IEC/EN61010-1
Measurement category: CAT IV 600V – CAT III 1000V
Size (LxWxH): 210x75x45mm
Weight (batteries included): 400g



Included accessories

4324-2	Pair of test leads with 2/4 mm tip
T10	Adapter for K-type wire probe
TK101	K-type wire probe
	Battery, User manual and Soft carrying bag



Technical Specifications

DC voltage

- Measuring range: 3mV ÷ 1000V
- Resolution: 0.1V ÷ 1V
- Basic accuracy: ±(1.0%reading + 3digits)
- Protection: 1000VDC/AC

AC voltage

- Measuring range: 0.03V ÷ 1000V
- Frequency band: 50 ÷ 400Hz
- Resolution: 0.01V ÷ 1V
- Basic accuracy: ±(1.0%reading + 10digits)
- Protection: 600Vrms

AC current

- Measuring range: 0.3A ÷ 600A
- Frequency band: 50 ÷ 400Hz
- Resolution: 0.1A ÷ 1A
- Basic accuracy: ±(2.8%reading + 8digits)
- Protection: 600Arms

Resistance and Continuity test

- Measuring range: 3Ω ÷ 60kΩ
- Resolution: 0.1Ω ÷ 0.01kΩ
- Basic accuracy: ±(1.0%reading + 5digits)
- Continuity test: <60Ω

Capacitance

- Measuring range: 0.2nF ÷ 4mF
- Resolution: 0.01μF ÷ 1μF
- Basic accuracy: ±(2.5%reading + 5digits)

Temperature with K-type probe

- Measuring range: -20°C ÷ 760°C
- Resolution: 0.1°C
- Basic accuracy: ±(2.0%reading + 3°C)

Frequency with test leads and clamp jaws

- Measuring range: 0.5Hz ÷ 60kHz
- Resolution: 0.01Hz ÷ 0.01kHz
- Basic accuracy: ±(1.0%reading + 5digits)
- Protection: 600A/600V



ORDER CODE **HP009012**

HT9012

PROFESSIONAL CLAMP METER AC 600A, CAT IV 600V

Professional clamp meter HT9012 has been designed to measure **AC current up to 600A and AC/DC voltage up to 1000V** to reach **CAT IV 600V and CAT III 1000V** in compliance with standard **IEC/EN61010-1**. The clamp is provided with a wide **backlight display with 6000 measuring spots** and an auto power off function to preserve its battery.



ORDER CODE **HP004013**

HT4013

CLAMP METER AC/DC 400A

Clamp meter HT4013 has been designed to measure **AC/DC current up to 400A and AC/DC voltage up to 600V** to reach **CAT III 600V** in compliance with standard **IEC/EN61010-1**. The clamp is provided with an internal sensor to detect AC voltage also without contact, through a red LED turning on. This model also carries out measurements of **Resistance, Continuity tests, Frequency, Capacitance, Diode test, Duty Cycle and Temperature with K-type probe**, among others. The clamp is also provided with the auto power off function to preserve its own battery.

Functions

- DC/AC voltage
- AC current
- Resistance / Continuity test
- "Voltsense" sensor
- Diode test
- Data HOLD
- MAX function
- Backlight
- AutoPowerOFF

Main features

Display:	LCD, 3½ digits, 2000 dots average value
Conversion type:	
Power supply:	1x9V battery type IEC 622
AutoPowerOFF:	after 30 minutes' idling
Clamp jaw internal diameter:	30mm
Safety:	IEC/EN61010-1
Measurement category:	CAT IV 600V – CAT III 1000V
Size (LxWxH):	210x75x45mm
Weight (batteries included):	400g

Technical Specifications

DC voltage

- Measuring range: 1mV ÷ 1000V
- Resolution: 0.1mV ÷ 1V
- Basic accuracy: ±(1%reading + 3digits)
- Protection: 1000V DC/AC

AC voltage

- Measuring range: 1mV ÷ 1000V
- Frequency band: 50 ÷ 60Hz
- Resolution: 0.1mV ÷ 1V
- Basic accuracy: ±(1%reading + 4digits)
- Protection: 1000V DC/AC

AC current

- Measuring range: 0.01A ÷ 600A
- Frequency band: 50 ÷ 60Hz
- Resolution: 1mA ÷ 1A
- Basic accuracy: ±(2.5%reading + 4digits)
- Protection: 600Arms

Resistance and Continuity test

- Measuring range: 1Ω ÷ 20MΩ
- Resolution: 0.1Ω ÷ 0.01MΩ
- Basic accuracy: ±(1.0%reading + 5digits)
- Continuity buzzer: <100Ω

Included accessories

4324-2	Pair of test leads with 2/4 mm tip
	Battery
	User manual and Soft carrying bag

Functions

- AC/DC current up to 400A
- AC/DC voltage up to 600V
- "Voltsense" for AC voltage detection
- Resistance and continuity test with buzzer
- Frequency with leads, Capacitance, Diode test
- Duty Cycle (%)
- Temperature with K-type probe
- Autorange, Data HOLD, MAX/MIN/Relative measurement

Main features

Display:	LCD, 4 digits, 4000 dots
Conversion type:	RMS
Power supply:	2x1.5V alkaline batteries type AAA LR03
Auto Power OFF:	after 30 minutes' idling
Max diameter of clamp:	30mm
Safety:	IEC/EN61010-1
Measurement category:	CAT III 600V
Insulation:	double insulation
Pollution level:	2
Size (LxWxH):	200x66x37mm
Weight (batteries included):	205g

Included accessories

4324-2	Pair of leads with 2/4mm tip
T10	Adapter for K-type wire probe
TK101	K-type wire probe
	Battery, User manual and Soft carrying bag

Technical Specifications

DC voltage (Autorange)

- Measuring range: 2mV ÷ 600V
- Resolution: 0.1mV ÷ 1V
- Basic accuracy: ±(0.8%reading + 2digits)
- Protection against overcharge: 600VDC/ACrms

AC voltage (Autorange)

- Measuring range: 0.02V ÷ 600V
- Frequency band: 50Hz ÷ 400Hz
- Resolution: 0,001V ÷ 1V
- Basic accuracy: ±(1.5%reading + 5digits)
- Protection against overcharge: 600VDC/ACrms

AC/DC current

- Measuring range: 0.2A ÷ 400A
- Resolution: 0.01A ÷ 1A
- Frequency range: 50Hz ÷ 60Hz
- Basic accuracy: ±(2.5%reading + 5digits)
- Protection against overcharge: 400Arms

Resistance and Continuity test

- Measuring range: 2Ω ÷ 40MΩ
- Resolution: 0.1Ω ÷ 0.01MΩ
- Basic accuracy: ±(1.0%reading + 4digits)
- Protection against overcharge: 600VDC/ACrms
- Continuity buzzer: <30Ω

Capacitance

- Measuring range: 0.2nF ÷ 100µF
- Resolution: 0.01nF ÷ 0.1µF
- Basic accuracy: ±(3.0%reading + 5digits)
- Protection against overcharge: 600VDC/ACrms

Frequency and Duty Cycle

- Measuring range: 10Hz ÷ 10kHz
- Resolution: 0.01Hz ÷ 0.01kHz
- Basic accuracy: ±(1.5%reading + 2digits)
- Protection against overcharge: 600VDC/ACrms
- Duty Cycle: Measuring range 0.5% ÷ 99%

Temperature with K-type probe

- Measuring range: -20°C ÷ 760°C
- Resolution: 0.1°C ÷ 1°C
- Basic accuracy: ±(3%reading + 5°C)



ORDER CODE **HP004022** | **HP004020**

HT4022 HT4020

AC TRMS 400A CLAMP METERS
WITH POWER/HARMONICS MEASUREMENT

Professional clamp meters HT4020 and HT4022 carry out measurements in TRMS of AC current up to 400A, AC/DC voltage up to 600V, Frequency, Resistance, Continuity test, Active, Reactive, Apparent Power, Cosφ, Energy for balanced single-phase and/or three-phase systems, further to the detection of phase sequence by 1-terminal method. HT4022 also carries out the absolute/percentage measurement of voltage and current harmonic components with calculation of THD%. Each device complies with IEC/EN61010-1 in CAT III 600V and is the ideal solution or troubleshooting typical problems in industrial environments such as non-linear loads, frequency-controlled motors.



Functions

	HT4022	HT4020
DC/AC TRMS voltage	•	•
AC TRMS current	•	•
Resistance and Continuity test	•	•
Frequency with test leads and clamp jaws	•	•
Active, Reactive, Apparent power	•	•
Active, Reactive, Apparent energy	•	•
Power factor and Cosφ	•	•
V/I harmonics up to the 25th and THD%	•	-
Phase sequence with 1 terminal	•	•
Autorange	•	•
Data HOLD	•	•
MAX/MIN/AVG/PEAK	•	•
Backlight	•	•
AutoPowerOFF	•	•

Main features

Display:	LCD, 4 digits, 10000 dots
Conversion type:	TRMS, 64 samples in 20ms
Power supply:	2x1.5V batteries type AAA LR03
Auto Power OFF:	after 5 minutes' idling
Safety:	IEC/EN 61010-1
Measurement category:	CAT III 600V
Pollution level:	2
Insulation:	double insulation
Max height:	2000m
Clamp jaw internal diameter	30mm
Size (LxWxH):	205x64x39mm
Weight (batteries included):	approx 280g

Included accessories

4413-2	Pair of test leads
YAAMK0001HT0	Pair of alligator clips
B80	Soft carrying bag
	Rubber cap for test lead
	ISO9000 calibration certificate
	Batteries and user manual

Technical Specifications

	HT4022	HT4020
DC voltage		
Measuring range:	0.1V ÷ 600V	0.1V ÷ 600V
Resolution:	0.1V	0.1V
Basic accuracy:	±(1.0%read. + 3digits)	±(1.0%read. + 3digits)
Protection:	600Vrms	600Vrms
AC TRMS voltage		
Measuring range:	1.6V ÷ 600V	1.6V ÷ 600V
Resolution:	0.1V	0.1V
Basic accuracy:	±(1.0%read. + 3digits)	±(1.0%read. + 3digits)
Protection:	600Vrms	600Vrms
AC TRMS current		
Measuring range:	0.1A ÷ 400A	0.1A ÷ 400A
Resolution:	0.1A	0.1A
Basic accuracy:	±(1.0%read. + 3digits)	±(1.0%read. + 3digits)
Protection:	600Arms	600Arms
Active, Reactive, Apparent AC power [kW, kVAR, kVA]		
Measuring range:	0.01 ÷ 1000	0.01 ÷ 1000
Resolution:	0.01 ÷ 0.1	0.01 ÷ 0.1
Basic accuracy:	±(3.5%read. + 3digits)	±(3.5%read. + 3digits)
Protection:	600V/600Arms	600V/600Arms

	HT4022	HT4020
Power factor and Cosφ		
Measuring range:	0.20 ÷ 1.00	0.20 ÷ 1.00
Resolution:	0.01	0.01
Basic accuracy:	±3°	±3°
voltage and current harmonics		
Harmonic order:	1 ÷ 25	-
Resolution [V, A]:	0.1	-
Basic accuracy:	±(10%read. + 5digits)	-
Resistance and Continuity test		
Measuring range:	0.1Ω ÷ 2kΩ	0.1Ω ÷ 2kΩ
Resolution:	0.1Ω ÷ 3Ω	0.1Ω ÷ 3Ω
Basic accuracy:	±(1.0%read. + 5digits)	±(1.0%read. + 5digits)
Continuity test	<40Ω	<40Ω
Protection:	600Vrms	600Vrms
Frequency with test leads and clamp jaws		
Measuring range:	40Hz ÷ 400Hz	40Hz ÷ 400Hz
Resolution:	0.1Hz	0.1Hz
Basic accuracy:	±(0.5%read.+ 1digit)	±(0.5%read.+ 1digit)
Protection:	600Vrms/600Arms	600Vrms/600Arms
Phase sequence with 1 terminal		
Measuring range:	50V ÷ 600V	50V ÷ 600V
Frequency range:	40Hz ÷ 69Hz	40Hz ÷ 69Hz
Protection:	600Vrms	600Vrms



ORDER CODE **HP004011**

HT4011

CLAMP METER AC 400A

Clamp meter HT4011 has been designed to measure **AC current up to 400A** and **AC/DC voltage up to 600V** to reach **CAT III 600V** in compliance with standard **IEC/EN61010-1**. The clamp is provided with an internal sensor to detect AC voltage also without contact, through a red LED turning on. HT4011 also carries out measurements of **Resistance, Continuity tests, Frequency, Capacitance, Diode test, Duty Cycle** and **Temperature with K-type probe**, among others. The clamp is also provided with the auto power off function to preserve its own battery.



ORDER CODE **HP004010**

HT4010

CLAMP METER AC 600A

Clamp meter HT4010 can carry out measurements of **AC current up to 600A** and **AC/DC voltage, Resistance, Continuity and Diode test**. The device is provided with an internal sensor capable of detecting, through a LED turning on and a buzzer sounding, the presence of AC voltage in a spot without contact. This device complies with standard **IEC/EN61010-1** in **CAT III 600V** and it is the ideal solution for measurements to be carried out both in domestic and in industrial environments.

Functions

- AC current up to 400A
- AC/DC voltage up to 600V
- "Voltsense" for AC voltage detection
- Resistance and continuity test with buzzer
- Frequency with leads, Capacitance, Diode test
- Duty Cycle (%)
- Temperature with K-type probe
- Autorange, Data HOLD, MAX/MIN/Relative measurement

Main features

Display:	LCD, 4 digits, 4000 dots average value
Conversion type:	2x1.5V batteries type AAA LR03
Power supply:	after 30 minutes' idling
Auto Power OFF:	30mm
Max diameter of clamp:	IEC/EN61010-1
Safety:	CAT III 600V
Measurement category:	double insulation
Insulation:	2
Pollution level:	200x66x37mm
Size (LxWxH):	205g
Weight (batteries included):	

Included accessories

4324-2	Pair of leads with 2/4mm tip
T10	Adapter for K-type wire probe
TK101	K-type wire probe
	Battery, User manual and Soft carrying bag

Technical Specifications

- DC voltage (Autorange)**
- Measuring range: 400mV ÷ 600V
 - Resolution: 0.1mV ÷ 0.1V
 - Basic accuracy: ±(0.8%reading + 2digits)
 - Protection against overcharge: 600VDC/ACrms
- AC voltage (Autorange)**
- Measuring range: 4V ÷ 600V
 - Frequency band: 50Hz ÷ 400Hz
 - Resolution: 0,001V ÷ 1V
 - Basic accuracy: ±(1.8%reading + 8digits)
 - Protection against overcharge: 600VDC/ACrms
- AC current**
- Measuring range: 0.2A ÷ 400A
 - Resolution: 0.01A ÷ 1A
 - Frequency range: 50Hz ÷ 60Hz
 - Basic accuracy: ±(2.5%reading + 8digits)
 - Protection against overcharge: 400Arms
- Resistance and Continuity test**
- Measuring range: 2Ω ÷ 40MΩ
 - Resolution: 0.1Ω ÷ 0.01MΩ
 - Basic accuracy: ±(1.0%reading + 5digits)
 - Protection against overcharge: 600VDC/ACrms
 - Continuity buzzer: <60Ω
- Capacitance**
- Measuring range: 0.2nF ÷ 400μF
 - Resolution: 0.01nF ÷ 0.1μF
 - Basic accuracy: ±(3.0%reading + 5digits)
 - Protection against overcharge: 600VDC/ACrms
- Frequency and Duty Cycle**
- Measuring range: 10Hz ÷ 10kHz
 - Resolution: 0.01Hz ÷ 0.01kHz
 - Basic accuracy: ±(1.5%reading + 2digits)
 - Protection against overcharge: 600VDC/ACrms
 - Duty Cycle: Measuring range 0.5% ÷ 99%;
- Temperature with K-type probe**
- Measuring range: -20°C ÷ 760°C
 - Resolution: 0.1°C ÷ 1°C
 - Basic accuracy: ±(3%reading + 5°C)

Functions

- AC current up to 600A
- AC/DC voltage up to 600V
- Detection of AC voltage without contact
- Resistance / Continuity test
- Diode test
- Data HOLD
- MAX
- Backlight
- Auto Power OFF

Main features

Display:	LCD, 3½ digits, 2000 dots average value
Conversion type:	1x9V battery type 6F22
Power supply:	after 15 minutes' idling
Auto Power OFF:	30mm
Clamp jaw internal diameter:	IEC/EN 61010-1
Safety:	CAT III 600V
Measurement category:	double insulation
Insulation:	2
Pollution level:	2000m
Max height:	197x70x40mm
Size (LxWxH):	180g
Weight (batteries included):	

Technical Specifications

- DC voltage**
- Measuring range: 1mV ÷ 600V
 - Resolution: 0.1mV ÷ 1V
 - Basic accuracy: ±(0.8%reading + 2 digits)
 - Protection against overcharge: 600Vrms
- AC voltage**
- Measuring range: 1mV ÷ 600V
 - Resolution: 0.1mV ÷ 1V
 - Frequency band: 50Hz ÷ 60Hz
 - Basic accuracy: ±(1.5%reading + 3.5mV)
 - Protection against overcharge: 600Vrms
- AC current**
- Measuring range: 0.01A ÷ 600A
 - Resolution: 1mA ÷ 0.1A
 - Frequency band: 50Hz ÷ 60Hz
 - Basic accuracy: ±(2.5%reading + 4digits)
 - Protection against overcharge: 600Arms
- Resistance and continuity test with buzzer**
- Measuring range: 1Ω ÷ 20MΩ
 - Resolution: 0.1Ω ÷ 0.01MΩ
 - Basic accuracy: ±(1.0%reading + 4digits)
 - Continuity buzzer: <150Ω

Included accessories

4324-2	Pair of test leads with 2/4mm tip
	Soft carrying bag, battery and user manual



ORDER CODE **HP030000**

F3000

CLAMP METER WITH FLEXIBLE CLAMP JAWS
AC 3000A

Professional clamp meter F3000 has been designed to measure **AC current up to 3000A in TRMS** in **total autorange** to reach **CAT IV 600V, CAT III 1000V** according to standard **IEC/EN61010-1**. The clamp is provided with innovative **flexible jaws** capable of reaching a **maximum diameter of 110mm** and allowing for an easy reading in any condition. The clamp is provided with a wide display with **3000 measuring spots**, **Data HOLD** function and **Backlight** to allow for a simple reading even in poorly lit environments. The clamp is also provided with the auto power off function to preserve its own battery.



ORDER CODE **HP000100**

HT100

FORK CLAMP METER
AC 200A TRMS

Professional clamp meter HT100 is provided with automatic recognition of functions. The measurement of **AC current up to 200A and AC/DC voltage up to 1000V in TRMS** reaches **CAT IV 600V and CAT III 1000V** in compliance with standard **IEC/EN61010-1**. The clamp is provided with **"open" jaws**, with a wide **display with 9999 measuring spots**, **"Voltsense"** phase detector function, **Data HOLD** and **backlight** to allow for a simple reading even in poorly lit environments. HT100 also carries out measurements of **Resistance, Continuity test** and **Diode test**. The clamp is also provided with the auto power off function to preserve its own battery.



Functions

- TRMS measurements
- AC TRMS current up to 3000A
- Flexible jaws with big diameter
- Autorange
- Data HOLD
- MAX/MIN
- Backlight
- Auto Power OFF

Technical Specifications

AC TRMS current

- Measuring range: 0.1A ÷ 3000A
- Resolution: 0.01 ÷ 1A
- Frequency range: 45Hz ÷ 500Hz
- Basic accuracy: ±(3%reading + 5digits)

Functions

- TRMS measurements
- AC TRMS current up to 200A
- DC/AC TRMS voltage up to 1000V
- "Voltsense" for AC voltage detection
- Resistance
- Continuity test with buzzer
- Diode test
- Autorange
- Autorecognition function
- Data HOLD
- Backlight
- Auto Power OFF

Technical Specifications

DC voltage (Autorange)

- Measuring range: 2.2V ÷ 1000V
- Resolution: 0.1V
- Basic accuracy: ±(0.3%reading + 2digits)
- Protection against overcharge: 1000VDC/ACrms

AC TRMS voltage (Autorange)

- Measuring range: 1.3V ÷ 1000V
- Frequency band: 50Hz ÷ 500Hz
- Resolution: 0.1V
- Basic accuracy: ±(0.9%reading + 3digits)
- Protection against overcharge: 1000VDC/ACrms

AC TRMS current (Autorange)

- Measuring range: 1.5A ÷ 200A
- Resolution: 0.1A
- Frequency range: 50Hz ÷ 60Hz
- Basic accuracy: ±(3%reading + 5digits)
- Protection against overcharge: 200Arms

Resistance and Continuity test

- Measuring range: 0Ω ÷ 9999Ω
- Resolution: 1Ω
- Basic accuracy: ±(0.9%reading + 2digits)
- Protection against overcharge: 1000VDC/ACrms
- Continuity buzzer: <25Ω

Diode test

- Measuring range: 0.4V ÷ 0.8V
- Resolution: 0.1V
- Basic accuracy: ±(1%reading + 3digits)
- Protection against overcharge: 1000VDC/ACrms

Main features

Display:	LCD, 4 digits, 3000 dots
Conversion type:	TRMS
Power supply:	2x1.5V alkaline batteries type AAA LR03
Auto Power OFF:	after 20 minutes' idling
Max diameter of clamp:	110mm
Safety:	IEC/EN61010-1
Measurement category:	CAT IV 600V - CAT III 1000V
Insulation:	double insulation
Pollution level:	2
Size (LxWxH):	280x120x25mm
Weight (batteries included):	170g

Included accessories

Batteries	
Soft carrying bag	
User Manual	

Main features

Display:	LCD, 4 digits, 10000 dots, backlight
Conversion type:	TRMS
Power supply:	2x1.5V alkaline batteries type AAA LR03
Auto Power OFF:	after 20 minutes' idling
Max diameter of clamp:	16mm
Safety:	IEC/EN61010-1
Measurement category:	CAT IV 600V, CAT III 600V
Insulation:	double insulation
Pollution level:	2
Size (LxWxH):	193x54x31mm
Weight (batteries included):	280g

Included accessories

4413-2	Pair of test leads
	Batteries and user manual

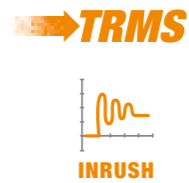

ORDER CODE **HP007004** | **HP007005**

HT7004 HT7005

POCKET CLAMP METERS
FOR TRMS AC CURRENT UP TO 400A
WITH MEASUREMENT OF INRUSH CURRENT

Clamp meter **HT7005** can measure **DC** and **AC TRMS** current up to **400A** in Autorange, in compliance with standard IEC/EN61010-1, CAT III 300V, **further to measuring the inrush current of electric motors** with a response time of **100ms**. **HT 7004** can measure **only AC TRMS current** up to **300A**. Both devices are provided with Data HOLD function and Auto Power Off function, in order to preserve the internal battery when not in use. Thanks to its **extremely small size**, these models are very practical and they are the ideal solution for simple measurements in the most common domestic and industrial environments.



TRMS

μA

CLASS 2

ORDER CODE **HP000079** | **HP00077C**

HT79|HT77C

CLAMP METERS
FOR MEASURING LEAKAGE CURRENT

HT77C and HT79 are clamp meters designed for an **accurate measurement of very low values of AC and DC currents** (DC only for HT79) and, therefore, they are mainly employed in detecting and defining **leakage currents** in **domestic and industrial electric systems**, which typically cause the RCDs' tripping. HT77C, in particular, complies with standards IEC/EN61557-13 and IEC/EN61557-16, which provide for a measurement protected against external disturbances. It is also provided with a **built-in low-pass filter to eliminate harmonic components**. HT79 also allows measuring **AC/DC voltage** and performing Resistance/Continuity tests. HT77C is also provided with Bluetooth connection for managing a datalogger function in combination with the APP HTLeakage

Functions

	HT7004	HT7005
AC TRMS current	300A •	400A •
DC current	-	400A •
Inrush current (INRUSH)	-	•
AC voltage detection without contact	•	•
Autorange	•	•
Data HOLD	•	•
ZERO function (zeroing)	-	•
Backlight	•	•
Auto Power OFF	•	•

Main features

Power supply:	2x1.5V batteries type AAA LR03
Safety:	IEC/EN61010-1
Measurement category:	CAT III 300V
Insulation:	double insulation
Pollution level:	2
Max operating altitude:	2000m
Display:	3¾ LCD, 4000 dots, decimal sign and point
Max cable diameter:	20mm
Size (LxWxH):	155x60x25mm
Weight (batteries included):	140g

Included accessories

Soft carrying bag
Batteries
User Manual

Functions

	HT77C	HT79
TRMS measurements	•	•
DC/AC voltage	-	• (300V)
DC current	-	• (10A)
AC current	• (60A)	• (20A)
Resistance / Continuity test	-	•
Low-pass filter	• (50Hz / 60Hz / 1kHz)	-
Data HOLD	•	•
Auto HOLD	•	-
Peak HOLD	•	-
Relative measurement (ZERO)	-	•
Autorange	•	•
Backlight	•	•
MAX/MIN	-	•
Auto Power OFF	•	•

Technical Specifications

	HT77C	HT79
AC TRMS current		
Measuring range:	0.001mA ÷ 60A	0.1mA ÷ 20A
Resolution:	0.001mA ÷ 0.01A	0.1mA ÷ 0.01A
Basic accuracy:	±(1.0%rdg. + 8digits)	±(1.0%rdg. + 5digits)
Protection:	max 60Arms	max 20Arms
DC current		
Measuring range:	-	0.1mA ÷ 10A
Resolution:	-	0.1mA ÷ 0.01A
Basic accuracy:	-	±(1.0%rdg. + 10digits)
Protection:	-	max 10ADC

Main features

Display:	LCD 4 digits, 6000 dots (HT77C) LCD 4 digits, 5000 dots (HT79)
Conversion type	TRMS
Power supply:	2x1.5V batteries type AAA LR03 (HT79) 2x1.5V batteries type AA LR06 (HT77C)
Safety:	IEC/EN 61010-1
Measurement category:	CAT III 600V (HT77C) CAT IV 300V (HT79)
Insulation:	double insulation
Pollution level:	2
Max operating altitude:	2000m
Max cable diameter:	40mm (HT77C) 23mm (HT79)
Auto Power OFF:	after 20 minutes' idling (HT77C) after 30 minutes' idling (HT79)
Size (LxWxH):	230x30x24mm (HT77C) 206x76x34mm (HT79)
Weight (batteries included):	500g (HT77C) 262g (HT79)

Provided accessories

Pair of test leads (HT79)
Soft transport bag
Batteries
User Manual



BURIED CABLE LOCALIZER AND REVOLUTION COUNTER

BURIED CABLE LOCALIZER AND REVOLUTION COUNTER

ORDER CODE **HR000036**

HT36

PORTABLE ITEM DETECTOR

HT36 is capable of detecting the presence of wood beams and conductive items, metal items and AC cables hidden inside walls and roofs, and other common materials. The instrument gives out a sound and shows a signal on the display after identifying the border of the item, in order to easily detect its central position.



HT-5000



HT2234N



HT36

	CABLE LOCALIZER	REVOLUTION COUNTER	STUD FINDER
Localization of buried cables and metal tubes	•	-	•(max depth 30mm)
Inductive pairing with 33kHz signal via antenna	•	-	-
Direct 33kHz pairing with external accessories	•	-	-
Selectable transmission power	•	-	-
Intermittent or continuous signal	•	-	•
Passive search mode without transmitter	•	-	-
Automatic depth measurement	•	-	-
Manual or automatic setting of sensitivity	•	-	-
Headset socket for noisy environments	•	-	-
Localization of wooden beams and metal objects	-	-	•(min. dimensions 30mmx30mm)
Localization of AC voltage cables in walls	•	-	•(max depth 50mm)
Measurement of speed of rotating parts in RPMs (rev/min) with and without contact	-	•	-
Events counter	-	•	-
Laser pointer	-	•	-
MAX / MIN / HOLD	-	•	-
AutoPowerOFF	-	•	•
Order code	HN500000	HA02234N	HR000036



Functions

- Detection of presence of hidden wood beams
- Detection of presence of hidden metal and conductive items
- Detection of presence of hidden cables with AC voltage
- Sound and analog bargraph
- AutoPowerOFF



Main features

Size of conductive items:	min 30x30mm
Depth of conductive items:	max 18mm
Diameter of metal items:	max 25mm
Depth of metal items:	max 30mm
Cables with AC voltage:	90V ÷ 250V / 50-60Hz
Depth of cables with AC voltage:	max 50mm
AutoPowerOFF:	after 30s
Power supply:	1x9V battery type IEC6F22
Size (LxWxH):	155x72x28 mm
Weight (batteries included):	approx 203g



Accessories provided

- Battery
- User Manual

BURIED CABLE LOCALIZER AND REVOLUTION COUNTER



ORDER CODE **HN500000**

HT-5000

PROFESSIONAL METAL TUBE AND BURIED CABLES TRACER

Civil engineering work is accelerated, earth-moving machines are used efficiently and the risk of accidents is minimised thanks to the HT-5000. This unit is especially designed **to know the position and the depth of underground pipes and cables or cabling plans in a very quick and easy way**. The model is composed by a **Transmitter** and a **Receiver** and the principle used is the propagation of a electromagnetic field inside a object crossed by a signal generated with a direct coupling (finding energized or not energized objects with accessible parts) and inductive coupling (signal spread by transmitter by integrated antenna) for finding of not accessible parts (e.g: earthmoving areas). The tracing can be performed also in passive mode by the use of receiver only in order to locate cable or pipes crossed by 50/60Hz electrical current or radiofrequency signals. Both transmitter and receiver are designed with **IP56** (protection by dust and water) for typical external "in field" environment and a wide number of optional accessories are available also for finding of non metal objects. Most of the times that device is used to **locate buried cables and iron pipelines**.



ORDER CODE **HA02234N**

HT2234N

PORTABLE REVOLUTION COUNTER

HT2234N is a **digital revolution counter** for measuring the speed of **rotating mechanical parts (discs, drive shafts, etc...)** both **with** and **without contact**, making use of a light beam transmitted and reflected by the target.



KITHT2234N Set of rubber spare parts + reflecting band

Functions

- Inductive pairing with 33kHz signal via antenna
- Direct 33kHz pairing with external accessories
- Selectable transmission power
- Intermittent or continuous signal
- Passive search mode without transmitter
- Automatic depth measurement
- Manual or automatic setting of sensitivity
- Headset socket for noisy environments

Included accessories

- Transmitter TX5000 and receiver RX5000
- Set of measuring cables with alligator clips
- Metal probe
- Batteries for transmitter and receiver, Soft carrying bag and user manual

Optional accessories

- 820005314 Clamp 100mm diameter for inductive pairing
- GOK50-R Kit of flexible probes for non-metallic objects
- 890008852 Set of cables (Schuko plug + cable with RJ11 + coax cable)

Main features

- Transmitter TX5000**
- Transmission power: 0.1W / 0.5W
 - Signal frequency: 33kHz
 - Mechanical protection: IP56 (dust and water)
 - Power supply: 6x1.5V batteries type IEC LR20
 - Size (LxWxH): 260 x 140 x 255mm
 - Weight (batteries included): 1.7 kg
- Receiver RX5000**
- Frequency range: 15kHz ÷ 23kHz, 50/60Hz (electric power)
 - Depth range: 0.3m ÷ 7m
 - Mechanical protection: IP56 (dust and water)
 - Power supply: 10x1.5V batteries type AA IEC LR6
 - Size (LxWxH): 600 x 252 x 99mm
 - Weight (batteries included): 2.5 kg

Functions

- Measurement of speed of rotating parts in RPMs (rev/min) with and without contact
- Events counter
- Laser pointer
- MAX / MIN / HOLD
- AutoPowerOFF

Included accessories

- Mechanical adapter + fastening screw
- Rubber protection ring
- Rubber terminals in different shapes
- Reflecting band
- Soft carrying bag
- Batteries
- User manual

Main features

- Meas. range of speed without contact: 10.00 ÷ 99999 rev/min
- Meas. range of speed with contact: 20.00 ÷ 29999 rev/min
- Resolution: 0.01 ÷ 1 rev/min
- Accuracy: ±(0.04%reading + 2digits)
- Meas. range of events counter: 0 ÷ 99999
- Response time: 0.7s (>60 rev/min)
- Distance from target: 50 ÷ 300mm
- Display: LCD, 5 digits, 99999 dots
- AutoPowerOFF: after 30min
- Power supply: 4x1.5V batteries A
- Size (LxWxH): 172x63x36 mm
- Weight (batteries included): approx 190g

Optional accessories

- KITHT2234N Set of rubber spare parts + reflecting band + fastening screw

PHASE SEQUENCE INDICATORS CIRCUIT BREAKER FINDER VOLTAGE DETECTORS



PHASE DETECTORS, SWITCH DETECTORS AND PHASE SEQUENCE INDICATORS



MAIN MEASUREMENTS	LINESPLITTER	HT82	HT70	HT20S	HT38	HT5
Measuring range	0÷240VAC 0÷16A 50÷60Hz	40÷600VAC 15÷400Hz	100÷1000VAC 50÷60Hz	100÷1000VAC 50÷60Hz	200÷250VAC 50Hz	60÷250VAC 50÷60Hz
Localization of protection devices	-	-	-	-	•	-
Detection of AC voltage without contact also on insulating sheaths	-	-	•	•	-	-
Indications "R" and "L" on the display to measure phase sequence	-	•	-	-	-	-
Phase sequence and phase concordance without contact also on insulating sheaths	-	-	•	-	-	-
LED and sound indications	-	-	•	•	•	•
Network voltage (L-N, L-PE, N-PE)	•	-	-	-	-	-
Absorbed phase current	•	-	-	-	-	-
Absorbed phase current multiplied by 10 (for low-power users)	•	-	-	-	-	-
Leakage current on protection conductor	•	-	-	-	-	-
Leakage current measured in differential mode (L-N)	•	-	-	-	-	-
ADDITIONAL MEASUREMENTS						
Test of neon-filled lamps	-	-	-	-	-	•
Test of internal gas of compact fluorescent lamps	-	-	-	-	-	•
Test of internal gas of energy-saving lamps	-	-	-	-	-	•
Test of internal gas of high and low-pressure sodium-vapor lamps	-	-	-	-	-	•
Test of internal gas of halogen lamps	-	-	-	-	-	•
Test of internal gas of mercury-vapor lamps	-	-	-	-	-	•
Phase detection function with contact for AC voltage 60-250V 50/60Hz	-	-	-	-	-	•
Continuity test on non-electronic starters/reactors	-	-	-	-	-	•
Diode test	-	-	-	-	-	•
ADDITIONAL CHARACTERISTICS						
LCD display	-	•	-	-	-	-
Sound indications with buzzer	-	-	•	•	•	•
Practical breast pocket holder	-	-	•	•	-	-
Anti-shock protection sheath	-	•	-	-	-	-
Integrated torch	-	-	-	•	-	•
Schuko plug	•	-	-	-	•	-
Measurement category	CAT II 240V	CAT III 600V	CAT IV 1000V	CAT IV 1000V	CAT III 250V	CAT II 300V
Reference standard for safety	IEC/EN61010-1, IEC/EN61010-02-030	IEC/EN61010-1	IEC/EN61010-1	IEC/EN61010-1	IEC/EN61010-1	IEC/EN61010-1
Power supply	240VAC (±10%) 50/60Hz	From mains	2x 1,5V AAA	2x 1,5V AAA	From mains (HT38T) 1x 9V (HT38R)	1x 9V
Size (LxWxH) (mm)	210x60x35mm	130x69x22	160x26x20	160x26x20	95x60x30	255x60x40
Weight in grams	385g	130g	48g	48g	140g	170g
Order code	HA000951	HA000156	HR000070	HR000296	HR000038	HA000138



ORDER CODE HA000951

LINESPLITTER

CONDUCTORS SPLITTER

LINESPLITTER is an indispensable accessory every time you need to measure the current/power absorption or leakage current of a single-phase load supplied from socket (max 16A). This accessory separates the active conductors and the protective conductor, thus making the following measuring spots directly accessible to suitable instruments (clamp meters, clamps for measuring leakage currents, wattmetric clamps, mains analyzers):

- Mains voltage (L-N, L-PE, N-PE)
- Absorbed phase current
- Absorbed phase current multiplied by 10 (for low-power users)
- Leakage current on protection conductor
- Leakage current measured in differential mode (L-N)

In particular, the comparison between the readings obtained in the two last measuring spots, also allows evaluating whether the leakage current flows to alternative paths to the protective conductor (e.g.: current leaked in water or in the metal tubes of a boiler, immersion pump, etc.).

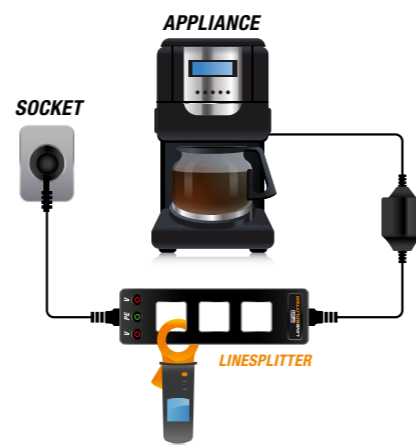

Functions

- Separation of phase conductor L from conductors N and PE on 2-pole and 3-pole cables
- Simple AC voltage measurement (L-N, L-PE, N-PE) through clamps/multimeters
- Simple AC current measurement through external clamps
- Current loop x1 for a direct measurement of AC current
- Current loop x10 for a direct measurement of low AC currents
- Direct measurement of leakage current on PE cable
- Indirect measurement of leakage current on L and N cables
- Use for loads with maximum current absorption 16A

Main features

Power supply:	240VAC (±10%) 50/60Hz
Connection to mains:	In-built Schuko plug, length 50cm
Connection to user:	In-built Schuko socket
Output current:	max 16A
Safety:	IEC/EN61010-1, IEC/EN61010-02-030
Measurement category:	CAT III 240V
Size (LxWxH):	210x60x35mm
Weight (batteries included):	385g

Accessories provided

User Manual



**PHASE DETECTORS,
SWITCH DETECTORS
AND PHASE
SEQUENCE
INDICATORS**



ORDER CODE **HA000156**

HT82

PHASE SEQUENCE

HT82 is a mobile device to display the **phase sequence** with **3 terminals** in a generic **three-phase** system. The device provides an **“R”** indication in case of **correct phase sequence** or **“L”** indication in case of **incorrect phase sequence**.



KIT82 Kit of 3 cables + 3 alligator clips.



ORDER CODE **HR000070 | HR000296**

HT70|HT20s

VOLTAGE DETECTOR WITH MEASUREMENT OF PHASE SEQUENCE (HT70)



HT70 is a practical innovative device capable of carrying out, further to the **phase detection** function, a **phase sequence** and **phase conformity** test with **LED** indications and **buzzer**, also on the **insulating sheath of the conductors**. The result of the test is indicated by the **red LED** (**incorrect phase sequence**) or the **green LED** (**correct phase sequence**) turning on, by simply moving the sensor first on the L1 and then on the L2 phase. HT20s is instead the model dedicated only to **searching live cables**. Also carries out measurements on insulating sheath of cables and therefore **without direct contact with live parts**.



Step1 - Take HT70 and rest it on the assumed phase L1 of the three-phase system (on the conductor or sheath) for **at least 5s** and wait for the **red LED** to flash together with the buzzer sounding.

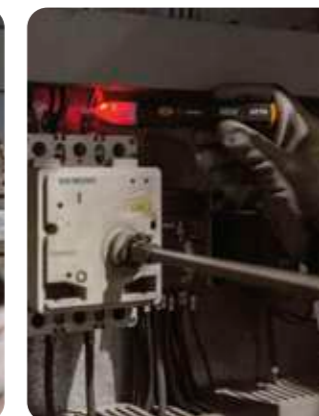

Step2 - Now rest and keep HT70 on the assumed phase L2 (on the conductor or sheath) for **at least another 5s** and wait for the **LED** to flash together with the buzzer sounding.



Step3 - If the **green LED** turns on with steady light, phase sequence is **correct**. If, however, the **red LED** flashes, phase sequence is **incorrect**.

Functions

- Phase sequence rotation measurement
- Direction indications “R” and “L” on the display to measure phase sequence

Main features

Power supply:	from power 40V ÷ 600V / 15-400Hz
Display:	LCD display
Pollution level:	2
Safety:	IEC/EN61010-1
Phase sequence rotation:	IEC/EN61557-7
Measurement category:	CAT III 600V
Size (LxWxH):	130x69x22mm
Weight (batteries included):	130 g

Included accessories

KIT82	Set of 3 cables + 3 alligator clips
	Bag and user manual

Optional accessories

404-IEC#	Measuring lead with safety cap, diameter 4mm
5004-IEC#	Insulated alligator clip (20A) for 4mm banana cables
5001-#	Cable with 4mm banana-banana connector, 1.5m long

Functions

	HT70	HT20s
AC voltage detection	•	•
Led and buzzer indication	•	•
Battery check with LED indication	•	•
Phase sequence detection	•	-
Pocket clip	•	•

Main features

AC reference voltage:	100V ÷ 1000V to earth
Frequency:	50/60Hz
Power supply:	2x1.5V alkaline batteries type AAA NEDA24A LR03
Pollution level:	2
Safety:	IEC/EN61010-1
Measurement category:	CAT IV 1000V
Size (LxWxH):	160x26x20mm
Weight (batteries included):	48 g

Included accessories

Battery
User manual



ORDER CODE **HR00038**

HT38

CIRCUIT BREAKER FINDER

HT38 belongs to that category of instruments (not necessarily meters) that make the job easier for all engineers that need to **detect reference switches** in power lines. The instrument consists of two elements: HT38T which, once plugged in, generates a signal and a receiver HT38R, that recognizes the signal, **indicates the reference switch** via a LED and a sound.



ORDER CODE **HA000138**

HT5

VOLTAGE DETECTOR
WITH TEST OF GAS-FILLED LAMPS

HT5 is a practical mobile device for **quickly carrying out tests on the operation of low-pressure, sodium-vapor -pressure and high-pressure internal gas lamps**, by simply touching the lamp's surface. Other available characteristics are the **phase detector function, Continuity test and Diode test**.



Functions

- LED visual indication and sound signalling with variable tone
- Location of security devices
- Use in circuits with voltage up to 250VAC to ground
- low battery level LED signalling
- Auto Power OFF



Included accessories

HT38T Transmitter
HT38R Receiver
Battery (receiver)
Transport bag
User manual



Main features of HT38T

Power supply:	230VAC, 50Hz
Max signal output current:	<20mA
External connection:	integrated Schuko Europlug plug
Operating temperature:	0°C ÷ 40°C (32°F ÷ 104°F)
Operating humidity:	<80%RH
Storage temperature:	0°C ÷ 50°C (32°F ÷ 122°F)
Storage humidity:	<95%RH
Dimensions (L x P x H):	95x60x30mm
Weight:	140 g



Main features of HT38R

Safety:	IEC/EN61010-1
EMC:	IEC/EN61326-1
Insulation:	double insulation
Pollution Level:	2
Measurement category:	CAT III 250V
Max operating altitude:	2000m



Functions and characteristics

- Operation test of neon and fluorescent tubes
- Operation test of neon lamps with E27 coupling
- Operation test of sodium-vapor lamps
- Operation test of halogen lamps
- Phase detector function for AC voltage 60-250V 50/60Hz
- Continuity test with buzzer
- Diode test
- LED indications and sound notifications
- Integrated torch



Main features

Power supply:	1x9V batteries type IEC 6F22
Safety:	IEC/EN61010-1
Measurement category:	CAT III 300V
Size (LxWxH):	255x60x40mm
Weight (batteries included):	170g



Included accessories

Batteries
User manual



LAN TESTERS

DEVICES FOR LAN NETWORK VERIFICATION

NEW



QUICKLAN6055



QUICKLAN6050N

MAIN MEASUREMENTS

	QUICKLAN6055	QUICKLAN6050N
Wire mapping of LAN cables	•	•
Test on twisted pair cables RJ45 type UTP, STP and FTP	•	•
Test on telephone cables with RJ11 connector	-	•
Verification on COAX cables	-	•
Errors of open pairs	•	•
Errors of shorted pairs	•	•
Errors of reversed pairs	•	•
Errors of crossed pairs	•	•
Errors of split pairs	•	•
Generic errors (MISWIRE)	•	•
Measurement of cable length	-	•
Cable length measuring range	-	1-255m

ADDITIONAL CHARACTERISTICS

Display indication of error type	•	•
Test indication OK - NOT OK	•	•
Remote unit recognition	•	•
AutoPowerOFF	•	•
Backlight	•	•
Low battery indication	•	•
Power supply	1x 9V	6x 1.5V AAA
Size (LxWxH) (mm)	128x67x39	156x73x35
Weight in grams (batteries included)	165	170
Order code	HV006055	HV006050



ORDER CODE HV006055

QUICKLAN6055

MOBILE DEVICE
FOR CABLE TESTS IN LAN NETWORKS

QUICKLAN6055 is capable of detecting and indicating on the display the presence of incorrect connections on LAN network cables (exchanged, split, inverted, open, short-circuited pairs, etc., both of type UTP (unshielded) and of type STP (shielded). This device is provided with more remote units and is capable of recognizing further ones (optional) in order to create an efficient localization action on different spots within a patch panel, carrying out tests very quickly with the aid of a single operator. QUICKLAN6055 is the ideal solution for any installer who needs a simple and efficient device to carry out preliminary checks and verifications on installations of LAN networks (also of PoE type) with connectors of type RJ45.



ORDER CODE HV006050

QUICKLAN6050N

PORTABLE DEVICE FOR VERIFICATION OF
LAN NETWORK CABLES AND LENGTH MEASUREMENT

QUICKLAN6050N is capable of detecting and indicating on the display the presence of incorrect connections on LAN network cables (exchanged, split, inverted, open, short-circuited, pairs, etc.) both of type UTP (unshielded) and of type STP (shielded) with connector RJ45, RJ11 and Coax F. The device is provided with more remote units and is capable of recognizing further ones (of type RJ45) in order to create an efficient localization action on different spots inside a patch panel, carrying out tests very quickly with the aid of a single operator. QUICKLAN6050N also measures the length of the single pairs of the cable.



Functions

- Cable mapping in LAN networks
- Test on twisted pair cables RJ45 type UTP, and STP
- Errors of open pairs
- Errors of short-circuited pairs
- Errors of exchanged pairs
- Errors of inverted pairs
- Errors of split pairs
- Generic errors (MISWIRE)
- Display indication of error type
- Indication of test passed/failed
- Remote unit recognition: 8
- AutoPowerOFF
- Low battery indication

Included accessories

CH1, CH2	Remote units #1 and #2
YAAMS0000000	Patch cable STP RJ45-RJ45, 20cm, 3 pieces
	Carrying bag
	User Manual
	Battery

Main features

Protection against voltage (PoE):	max 24V
Size (LxWxH):	190x65x45mm
Weight (battery excluded):	235g
Size of remote unit (LxLaxH):	30x25x27mm
Remote unit weight:	13g
Considered standard:	TIA/EIA 568B

Optional accessories

REM3	Remote unit #3 + patch cable RJ45-RJ45 STP
REM4	Remote unit #4 + patch cable RJ45-RJ45 STP
REM5	Remote unit #5 + patch cable RJ45-RJ45 STP
REM6	Remote unit #6 + patch cable RJ45-RJ45 STP
REM7	Remote unit #7 + patch cable RJ45-RJ45 STP
REM8	Remote unit #8 + patch cable RJ45-RJ45 STP
REM38	Remote unit #3 - #8 + 6 patch cables RJ45-RJ45 STP

Functions

- Test of wiring errors on LAN network cables with RJ45 connector in CAT5 and CAT6
- Test of wiring errors on telephone network cables with RJ11 connector
- Test of wiring errors on COAX cables with F connector
- Detection of wiring errors on UTP (unshielded) and STP (shielded) cables
- Detection of up to 4 remote units for multiple tests.
- Measurement of cable length from 10m to 250m
- Backlight
- Auto Power OFF

Included accessories

RT-01	Remote unit RJ45 #1 + 2 patch cables RJ45 STP, 20cm
RT-RJX1	Remote unit RJ11/COAX + patch cable RJ11 + patch cable COAXF
	Carrying bag
	Batteries
	User Manual

Main features

Input connectors:	RJ45, RJ11, COAX F
Power supply:	6x1.5V batteries type AAA LR03
Size (LxWxH):	156x73x35mm
Weight (battery included):	170g
Size of rem. unit (LxLaxH):	72x20x23mm
Remote unit weight:	25g

Optional accessories

RT-0204	Set of remote units RJ45 #2, #3, #4 + 3 patch cables RJ45 STP 20cm
---------	--



INFRARED CAMERAS



INFRARED THERMAL CAMERAS

Simply advanced.



- Capacitive touch screen extra-bright
- Interchangeable optics Optional equipment
- Laser pointer
- Optical thermal camera in visible range
- Integrated Flash LED
- Up to 3 independent pointers
- Preset selection properties of materials
- Multi-areas with independent pointers
- 50 hz Fluid image also on moving targets
- High resolution for sharp images
384x288
160x120
80x80
32x31
pixels
- Pi.P. fusion Overlapping visual + thermographic image
- HDMI™ Micro USB™ UNIVERSAL SERIAL BUS
PC USB 2.0 connection
HDMI video output
Data saving on MicroSD card
- THT45W Use with the THTview™ App for iOS™ and Android™ systems
- Temperature range -20 → +400 °C
- Automatic adjustment of SPAN
- 0,05 °C Higher thermal sensitivity
- Rechargeable batteries and battery chargers
- Recording of IR videos
- Voice notes
- Text notes

Industrial, electrical or construction. Excellent in any sector.

The new THT range makes use of a highly **innovative technology** to deliver **performance at affordable prices**. The use of IR technology today applies to many sectors, from industry to construction, from systems to installation. Thanks to the **innovative icon display**, the wide **capacitive touch screen display** and the very high **infrared resolution** with 384x288 pixels and 160x120 pixels (80x80 pixels for THT45W), identifying those problems which are not visible to the naked eye becomes simpler and more intuitive.

The new THT thermal cameras are provided with Flash Led*, Laser pointer*, photo-camera for visual images and PiP* and optional interchangeable optics**. With the provided 8GB memory card, with which you will be able to take hundreds of pictures, it will be possible to prepare **reports complete with images, audio and text comments**. With the new THT thermal cameras, **thermographic analysis** will be **simple and quick**.

* THT70, THT60 and THT45W. ** Only THT60 and THT70. *** The THTview App is available for free download in the Apple Store™ and Google Play™ store.

INFRARED THERMAL CAMERAS

NEW **NEW**



CHARACTERISTICS OF IR IMAGE

	THT70	THT60	THT46	THT45W	MERCURY	ECLIPSE	THT33
IR sensor resolution	384 x 288	160 x 120	160 x 120	80 x 80	80 x 80	80 x 80	80 x 80
Temperature range	-20 ÷ 650°C -4 ÷ 1202°F	-20 ÷ 650°C -4 ÷ 1202°F	-20 ÷ 350°C -4 ÷ 662°F	-20 ÷ 350°C -4 ÷ 662°F	-20 ÷ 260°C -4 ÷ 500°F	-20 ÷ 260°C -4 ÷ 500°F	-20 ÷ 380°C -4 ÷ 716°F
Thermal sensitivity	< 0.05°C @ 30°C	< 0.05°C @ 30°C	< 0.1°C @ 30°C	< 0.1°C @ 30°C	< 0.1°C @ 30°C	< 0.1°C @ 30°C	< 0.1°C @ 30°C
NETD	< 50mK	< 50mK	< 100mK	< 100mK	< 100mK	< 100mK	< 100mK
Spectrum range	8 ÷ 14µm	8 ÷ 14µm	8 ÷ 14µm	8 ÷ 14µm	8 ÷ 14µm	8 ÷ 14µm	8 ÷ 14µm
IFOV (@1m)	0.77mrad	1.89mrad	2.78mrad	3.78mrad	4.53mrad	4.53mrad	4.53mrad
Type of IR sensor	UFPA	UFPA	UFPA	UFPA	UFPA	UFPA	UFPA
Frequency	50Hz	50Hz	50Hz	50Hz	50Hz	50Hz	50Hz

CHARACTERISTICS OF IR OPTICS AND BUILT-IN PHOTO CAMERA

Field of view (FOV)	17° X 12.7°	17.3° x 13°	25° X 19°	17° X 17°	21° X 21°	21° X 21°	21° X 21°
Focus width of standard lens	22mm	9mm	9mm	9mm	7,5mm	7,5mm	7,5mm
Focusing of IR optics	Manual	Manual	Manual	Manual	Fixed	Fixed	Fixed
Resolution and FOV of visual camera	5Mpxl, FOV 59°	5Mpxl, FOV 59°	1.3Mpxl, FOV 59°	1.3Mpxl, FOV 59°	-	-	-

FUNCTIONS

Fusion PiP function for combination of thermal and visual images	•	•	•	•	-	-	-
Screening function for frontal temperature measurement	•	•	•	•	-	-	•
3 cursors: Central, Min, Max.	•	•	•	•	•	•	•
Advanced analysis: Spots, Lines, Areas on images and Isotherm line function	•	•	-	-	-	-	-
Correction according to distance, reflected temperature and relative humidity	•	•	Only reflected temperature	Only reflected temperature	-	-	-
Colour palettes	• 8 standard	• 8 standard	• 4 standard	• 4 standard	• 5 standard	• 5 standard	• 5 standard
Integrated table with emissivity values of common materials	•	•	•	•	-	-	-
Alarm thresholds on temperature measurement	•	•	-	-	-	-	•
Readings in °C, °F, K	•	•	•	•	•	•	•
Class 2 laser pointer	•	•	•	•	•	•	-
Integrated white light illuminator	•	•	•	•	•	•	-
Digital zoom	1x ÷ 32x	1x ÷ 32x	1x ÷ 32x	1x ÷ 32x	-	-	-
Manual and automatic span	•	•	•	•	Auto only	Auto only	•
Vertical and horizontal lines	•	•	-	-	-	-	-

NEW **NEW**



DATA SAVING

	THT70	THT60	THT46	THT45W	MERCURY	ECLIPSE	THT33
Standard format of saved images JPEG	•	•	•	•	• (BMP)	• (BMP)	• (BMP)
Saving of IR videos and audio comments in MPEG4 format	•	•	•	•	-	-	-
Voice and text annotation	•	•	-	-	-	-	-

ADDITIONAL CHARACTERISTICS

Capacitive touch-screen colour display	•	•	-	-	-	-	-
Power supply with rechargeable battery	•	•	•	•	•	•	•
USB interface to PC and THTLink software	•	•	•	•	-	-	-
Video output	• HDMI	• HDMI	• HDMI	• HDMI	-	-	-
WiFi function for connection to mobile devices	• with APP HTProCamera	• with APP HTProCamera	-	• with APP THTview	-	-	-
Bluetooth function for connection to mobile devices	-	-	-	-	• with APP HTMercury	• with APP HTMercury	• with APP HTMercury

POWER SUPPLY

Battery type	Li-ION rechargeable 3,7V 5200mAh	Li-ION rechargeable 3,7V 5200mAh	rechargeable Li-ION 3,7V 2000mAh	rechargeable Li-ION 3,7V 2000mAh	rechargeable Li-ION 7,4V 2300mAh	rechargeable Li-ION 7,4V 1200mAh	rechargeable Li-ION 3,7V 1300mAh
Recharging system	On thermal camera or external recharging base	On thermal camera or external recharging base	On thermal camera	On thermal camera	External recharging base	External recharging base	On thermal camera (USB/ power supply)
Duration	3 hours	3 hours	4 hours	4 hours	2 hours	8 hours	5 hours
External power supply	External power supply 100/240VAC (50/60Hz)/5VDC	External power supply 100/240VAC (50/60Hz)/5VDC	External power supply 100/240VAC (50/60Hz)/5VDC	External power supply 100/240VAC (50/60Hz)/5VDC	External power supply 100/240VAC (50/60Hz)/10VDC	External power supply 100/240VAC (50/60Hz)/10VDC	External power supply 100/240VAC (50/60Hz)/5VDC

GENERAL CHARACTERISTICS

Operating temperature	-15°C ÷ 50°C	-15°C ÷ 50°C	-15°C ÷ 50°C	-15°C ÷ 50°C	5°C ÷ 40°C	5°C ÷ 40°C	-10°C ÷ 45°C
Operating humidity	10% ÷ 90%HR	10% ÷ 90%HR	10% ÷ 90%HR	10% ÷ 90%HR	<80%RH	<80%RH	<80%RH
Storage temperature	-40°C ÷ 70°C	-40°C ÷ 70°C	-40°C ÷ 70°C	-40°C ÷ 70°C	-20°C ÷ 60°C	-20°C ÷ 60°C	-20°C ÷ 60°C
Storage humidity	10% ÷ 90%HR	10% ÷ 90%HR	10% ÷ 90%HR	10% ÷ 90%HR	<80%RH	<80%RH	<80%RH
Ingress protection	IP54 in compliance with IEC529	IP54 in compliance with IEC529	IP50 in compliance with IEC529	IP50 in compliance with IEC529	IP65 in compliance with IEC529	IP40 in compliance with IEC529	IP54 in compliance with IEC529
Shock	25G, in compliance with IEC60068-2-29	25G, in compliance with IEC60068-2-29	25G, in compliance with IEC60068-2-29	25G, in compliance with IEC60068-2-29	-	-	-
Vibrations	2G, in compliance with IEC60068-2-6	2G, in compliance with IEC60068-2-6	2G, in compliance with IEC60068-2-6	2G, in compliance with IEC60068-2-6	-	-	-
Falling test	2m	2m	2m	2m	-	-	2m
Size (L x W x H)	260x101x120mm	260x101x120mm	224x77x96mm	224x77x96mm	190x75x55mm	280x100x50mm	180x60x75mm
Weight (battery included)	0.85kg	0.85kg	0.5kg	0.5kg	0.55kg	0.50kg	0.26kg
Order code	HN000070	HN000600	HN000046	HN000045	HR000MER	HP000ECL	HN000033



ORDER CODE **HN000070**

THT70

ADVANCED INFRARED THERMAL IMAGING CAMERA WITH TOUCH SCREEN WITH RESOLUTION 384x288pxl

THT70 is the new professional thermal imaging camera provided with an IR sensor with high resolution 384x288pxl which makes it suitable for use both in industrial environments and in the construction sector, further to human temperature screening. It is provided with two specific measuring ranges, a standard one: $-20^{\circ}\text{C} \div 650.0^{\circ}\text{C}$, and one for the screening mode: $32.0^{\circ}\text{C} \div 42.0^{\circ}\text{C}$. It produces infrared images and videos with high resolution. The thermal imaging camera has a wide range of tools for an advanced analysis of thermographic images.

THT70 is provided with a modern internal icon structure and a capacitive colour touch-screen display with high brightness. It is also provided with Wi-Fi connection, which can be used via the dedicated APP HT Pro Camera.

384 x 288
pixel

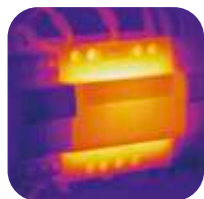

THT70 384x288pxl

Functions and characteristics

Characteristics of IR image

- IR sensor resolution: 384x288pxl /17µm
- Temperature range: $-20^{\circ}\text{C} \div 650^{\circ}\text{C}$
- Screening mode temperature range: $32^{\circ}\text{C} \div 42^{\circ}\text{C}$
- Thermal sensitivity: $<0.05^{\circ} \text{ @ } 30^{\circ}\text{C}$
- NETD: $<50\text{mK}$
- Spectrum range: $8 \div 14\mu\text{m}$
- IFOV (@1m): 0.77mrad
- Type of IR sensor: UFPA
- Frequency: 50Hz

Characteristics of IR and integrated optics

- Field of view (FOV): $17^{\circ} \times 12.7^{\circ}$
- Focus width of standard lens: 22mm
- Focusing of IR optics: manual
- Integrated photo-camera resolution: 5Mpxl, FOV 59°

Functions

- Fusion PIP function for combination of thermal and visual images
- 3 cursors: Central, Min, Max.
- Advanced analysis: Spots, Lines, Areas on images and Isotherm line
- Correction according to distance, reflected temperature and relative humidity
- 8 standard + 4 isotherm line colour palettes
- Integrated table with emissivity values of common materials
- Alarm thresholds on temperature measurement
- Measurement of the distance from target with laser pointer
- Readings in $^{\circ}\text{C}$, $^{\circ}\text{F}$, $^{\circ}\text{K}$
- Class 2 laser pointer
- Integrated white light illuminator

Data saving

- Saved image format: JPEG/HIR
- Saving of IR videos in MPEG4 format
- Voice and text annotation

Additional characteristics

- Capacitive colour touch-screen display
- Power supply with rechargeable battery
- USB interface to PC
- HDMI video output



Provided accessories

	22mm optic lens with protection cover
	Micro SD Card 8GB + adapter
BAT8X	Rechargeable Li-ION battery (2pcs)
	Battery recharging base
	USB cable for PC connection
	HDMI video cable
	AC/DC power supply + universal plugs
	Headset with microphone
	User manual on CD-ROM + Quick guide
	Windows software THTLink
	Hard carrying case
	Non-slip strap
	ISO calibration report

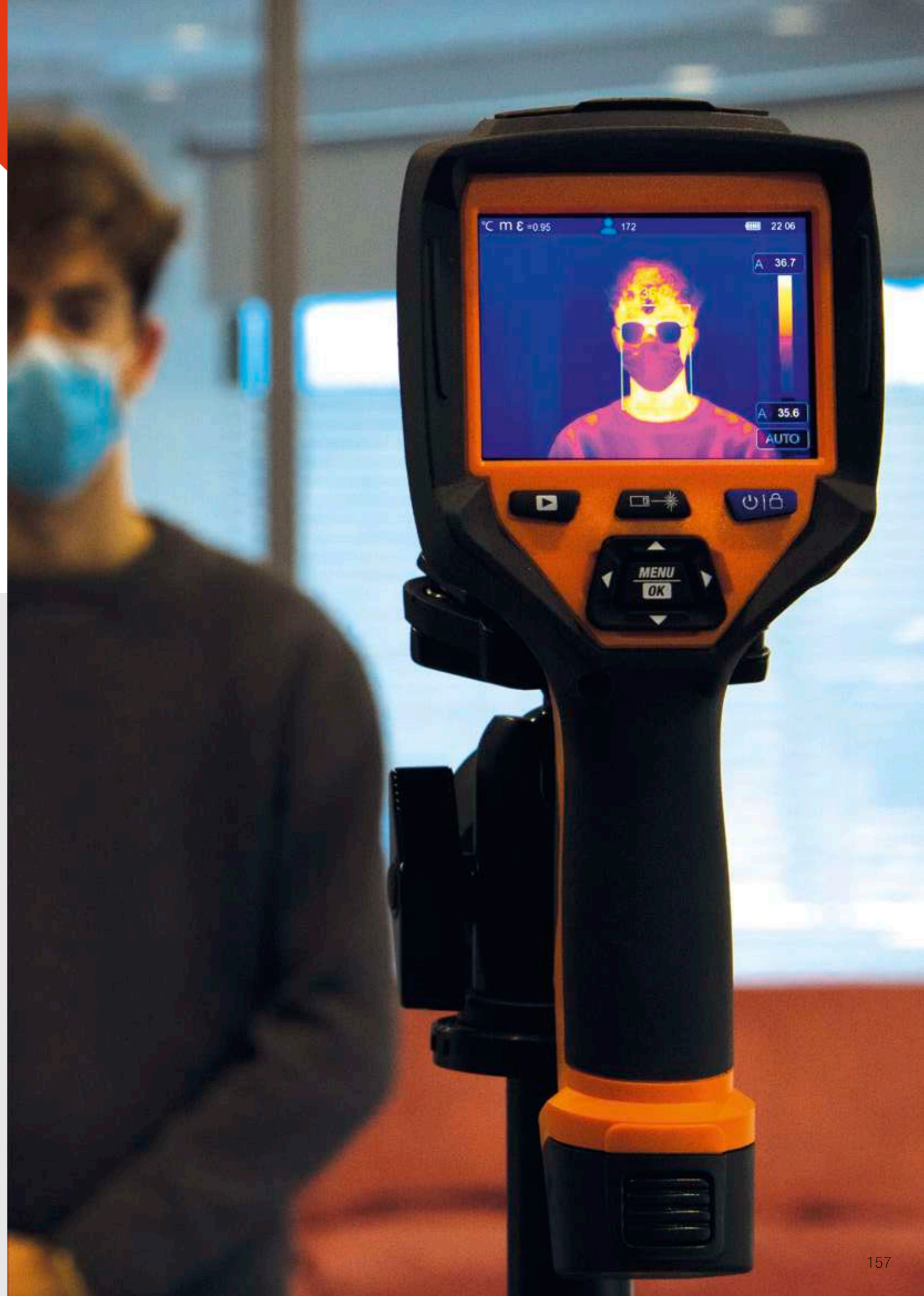



ORDER CODE **HN000060**

THT60

ADVANCED INFRARED THERMAL IMAGING CAMERA WITH TOUCH SCREEN WITH RESOLUTION 160X120pxl

THT60 is the new professional thermal imaging camera provided with an IR sensor with high resolution 160x120pxl which makes it suitable for use both in industrial environments and in the construction sector, further to human temperature screening. It is provided with two specific measuring ranges, a standard one: -20°C ÷ 650.0°C, and one for the screening mode: 32.0°C ÷ 42.0°C. It produces infrared images and videos with high resolution. The thermal imaging camera has a wide range of tools for an advanced analysis of thermographic images.

THT60 is provided with a modern internal icon structure and a capacitive colour touch-screen display with high brightness. It is also provided with Wi-Fi connection, which can be used via the dedicated APP HT Pro Camera.

160 x 120
pixel

YouTube

WiFi

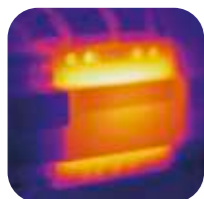

THT60 160x120pxl

160x120
80x80
pixel

YouTube

ORDER CODE **HN000046** | **HN000045**

THT46 | THT45W

COMPACT INFRARED THERMAL CAMERAS WITH FUNCTION PiP

THT45W and THT46 are an absolute innovation in the sector of thermal cameras, both for the advanced performance typical of a high-level thermal camera and for their reduced size. THT45W is provided with IR sensor with resolution 80x80pxl which makes it the ideal device for maintenance operations and everyday analysis. THT46, which has a resolution of 160x120pxl, has an even more advanced performance which allows a better definition of the infrared image. They are provided with an LCD colour display with high brightness and by a drop-down menu very easy to use, which allow for a simple programming by means of a keypad. The temperature range is very wide (-20°C at 350°C) and it is possible to save both thermal images and visual images in a standard JPG format on a micro SD card. It is also possible to transfer data onto the PC via USB. Recording of IR videos is also available. Thermal cameras THT45W and THT46 are the ideal partner for detecting electric problems, checking mechanical parts, analyzing hydraulic systems, forced ventilation, etc. These thermal cameras are completed by the SPAN function (creation of a temperature range of interest) and the automatic setting of emissivity with a preset table of materials. They also have a Screening mode for human frontal temperature.

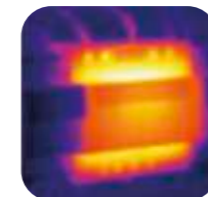

THT45 80x80pxl



THT46 160x120pxl



Functions and characteristics

Characteristics of IR image

- IR sensor resolution: 160x120pxl / 17µm
- Temperature range: -20°C ÷ 650°C
- Screening mode temperature range: 32°C ÷ 42°C
- Thermal sensitivity: <0.05° @ 30°C
- NETD: <50mK
- Spectrum range: 8÷14µm
- IFOV (@1m): 1,89mrad
- Type of IR sensor: UFPA
- Frequency: 50Hz

Characteristics of IR and integrated optics

- Field of view (FOV): 17.3° x 13°
- Focus width of standard lens: 9mm
- Focusing of IR optics: manual
- Integrated photo-camera resolution: 5Mpxl, FOV 59°

Functions

- Fusion PiP function for combination of thermal and visual images
- 3 cursors: Central, Min, Max.
- Advanced analysis: Spots, Lines, Areas on images and Isotherm line
- Correction according to distance, reflected temperature and relative humidity
- 8 standard + 4 isotherm line colour palettes
- Integrated table with emissivity values of common materials
- Alarm thresholds on temperature measurement
- Measurement of the distance from target with laser pointer
- Readings in °C, °F, °K
- Class 2 laser pointer

Data saving

- Saved image format: JPEG/HR
- Saving of IR videos in MPEG4 format
- Voice and text annotation

Additional characteristics

- Capacitive colour touch-screen display
- Power supply with rechargeable battery
- USB interface to PC
- HDMI video output



Provided accessories

	22mm optic lens with protection cover
	Micro SD Card 8GB + adapter
BAT8X	Rechargeable Li-ION battery (2pcs)
	Battery recharging base
	USB cable for PC connection
	HDMI video cable
	AC/DC power supply + universal plugs
	Headset with microphone
	User manual on CD-ROM + Quick guide
	Windows software THTLink
	Hard carrying case
	Non-slip strap
	ISO calibration report

Functions and characteristics

	THT46	THT45W
IR image features		
IR sensor resolution	160x120pxl/25µm	80x80pxl/34µm
Temperature range -20°C a 350°C	•	•
Thermal sensitivity < 0,1° @ 30°C	•	•
Screening mode range	32°C÷42°C	32°C÷42°C
NETD: < 100mK	•	•
Spectral range 8÷14µm	•	•
IFOV (@1m)	2.78mrad	3.78mrad
Sensor type IR UFPA	•	•
Frequency 50Hz	•	•
IR and integrated optical system features		
Field of view	25° x 19°	17° x 17°
Standard lens focal length 9 mm	•	•
Manual IR optical system focus	•	•
Functions		
PiP Fusion function to mix thermal images with visual images	•	•
3 cursors: Central, Min, Max.	•	•
Reflected temperature correction	•	•
4 color palettes	•	•
Integrated emissivity table of common materials	•	•
Readout in °C, °F, °K	•	•
Laser pointer Class 2	•	•
Built-in white light lamp	•	•
Data saving		
Images saved in standard JPEG format	•	•
Saving IR video and audio in MPEG4 format	•	•

	THT46	THT45W
Additional features		
Powering with rechargeable battery	•	•
USB port for PC connection	•	•
HDMI output	•	•
WiFi connection for communication with mobile devices	-	• through THTview



Included accessories

	Micro SD Card 8GB
BAT45N	Rechargeable Li-ION battery
	USB cable for PC connection
	HDMI Video Cable
A0045U	Universal Mini USB adapter + AC/DC plug
	Headset with microphone
	User manual on CD-ROM + quick guide
B45	Soft bag for transport
THTLink	Windows software
	Calibration certificate ISO9000

80x80
pixel



ORDER CODE **HN000033**

THT33

INFRARED THERMAL CAMERA
WITH RESOLUTION 80x80 AND BLUETOOTH CONNECTION

THT33 is a thermal camera with **reduced size** provided with IR sensor with resolution **80x80pxl**, which makes it the ideal device for maintenance operations and **everyday analysis**. It also has a Screening mode for human frontal temperature. THT33 has an **LCD colour display** and a **very simple** menu which allows for a **simple programming**. The temperature range is very wide (**-20°C to 380°C**) and it is possible to save **thermal images** in a BMP format in the internal memory, or to transfer the captured snapshots to mobile devices through the dedicated APP **HTMercury** using the Bluetooth connection. Within the APP, it is possible to carry out advanced analyses and create PDF reports which can be shared by mail and/or via social networks. Thermal camera THT33 is the **ideal solution for detecting** electric problems, checking mechanical parts, analyzing hydraulic systems and forced ventilation systems.



App HT Mercury33



Functions and features

Characteristics of IR and integrated optics

- Field of view (FOV): 21°x 21°
- Automatic focusing

Functions

- 3 cursors: Central, Max, Min
- Emissivity adjustable from 0.10 to 1.00
- 5 colour palettes
- Reading in °C, °F
- HOLD function

Data saving

- BMP format of saved images
- Saving in the internal memory (max 20 images)
- Download of images to mobile devices via Bluetooth and APP HTMercury

Additional characteristics

- Power supply with rechargeable Li-ION battery
- USB interface for battery recharge
- Alarms on temperature measurement
- Automatic/Manual temperature span
- D/S ratio: 74:1

Characteristics of IR image

- Resolution of IR sensor: 80x80pxl
- Temperature range: -20°C ÷ 380°C
- Screening mode temperature range: 32°C÷42°C
- Thermal sensitivity: <0.1°C @ 30°C
- NETD: <100mK
- Spectrum range: 8 ÷ 14µm
- Type of IR sensor: UFPA
- Frequency: 50Hz



Included accessories

- Built-in rechargeable Li-ION battery
- Battery charger power supply
- USB cable for battery recharge
- Carrying bag
- Non-slip strap
- User Manual
- ISO9000 calibration certificate

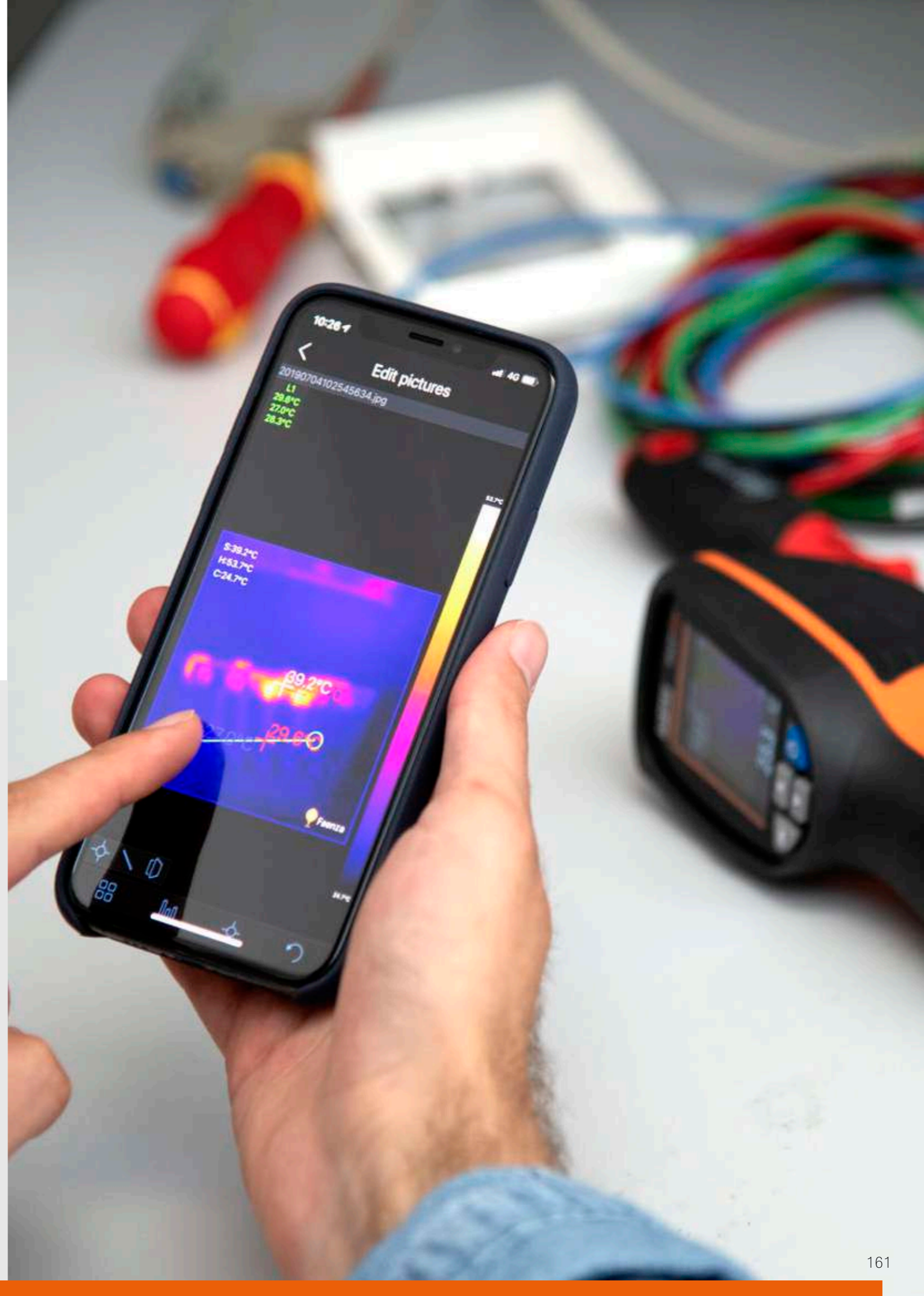

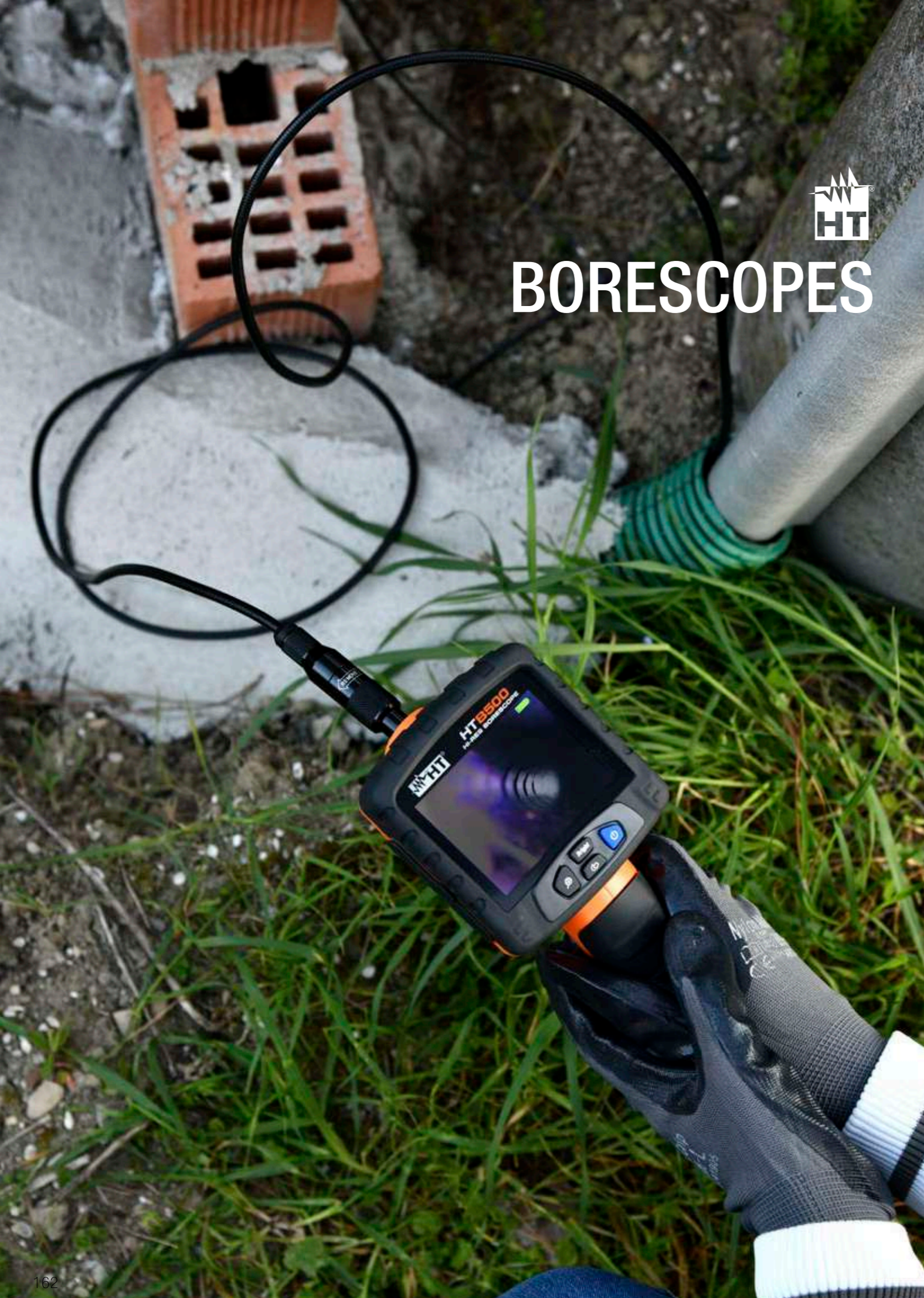

BORESCOPIES

BOROSCOPES

320x240
pixel

ORDER CODE **HN000108**

HTB500

PROFESSIONAL BORESCOPE WITH BUILT-IN HIGH-RESOLUTION PHOTO CAMERA

HTB500 is a portable digital borescope which allows carrying out inspections inside parts of objects not physically accessible (typically rotating equipment) and not visible to the naked eye. The instrument uses a waterproof external feeler with 4 LEDs with high brightness and a photo camera, in order to obtain a high-resolution image on the display.



Functions and characteristics

- Real-time display of the item
- Waterproof flexible external feeler (IP67)
- Built-in white-light LEDs for operations in poorly lit environments
- Image rotation (0° - 180°) on the display
- Li-ION battery rechargeable through USB
- Analog video output (PAL/NTSC)
- Electronic image zoom
- Resolution of the internal photo camera: 640x480pxl
- Display: 3.5", TFT colour, 320 x240pxl
- Automatic focusing: 5cm ÷ 15cm
- External feeler length: 1m
- External feeler diameter: 6mm
- Adjustment of white light brightness: 10 levels
- Size (L x W x H): 250x100x95mm
- Weight (without probe): 345g



Accessories provided

- Flexible external feeler L=1m, D=6mm with accessories
- Rechargeable Li-ION battery
- USB cable for battery recharge
- Carrying bag
- User Manual



Optional accessories

- BP36 IP67 probe for inspections up to 3 meters deep.

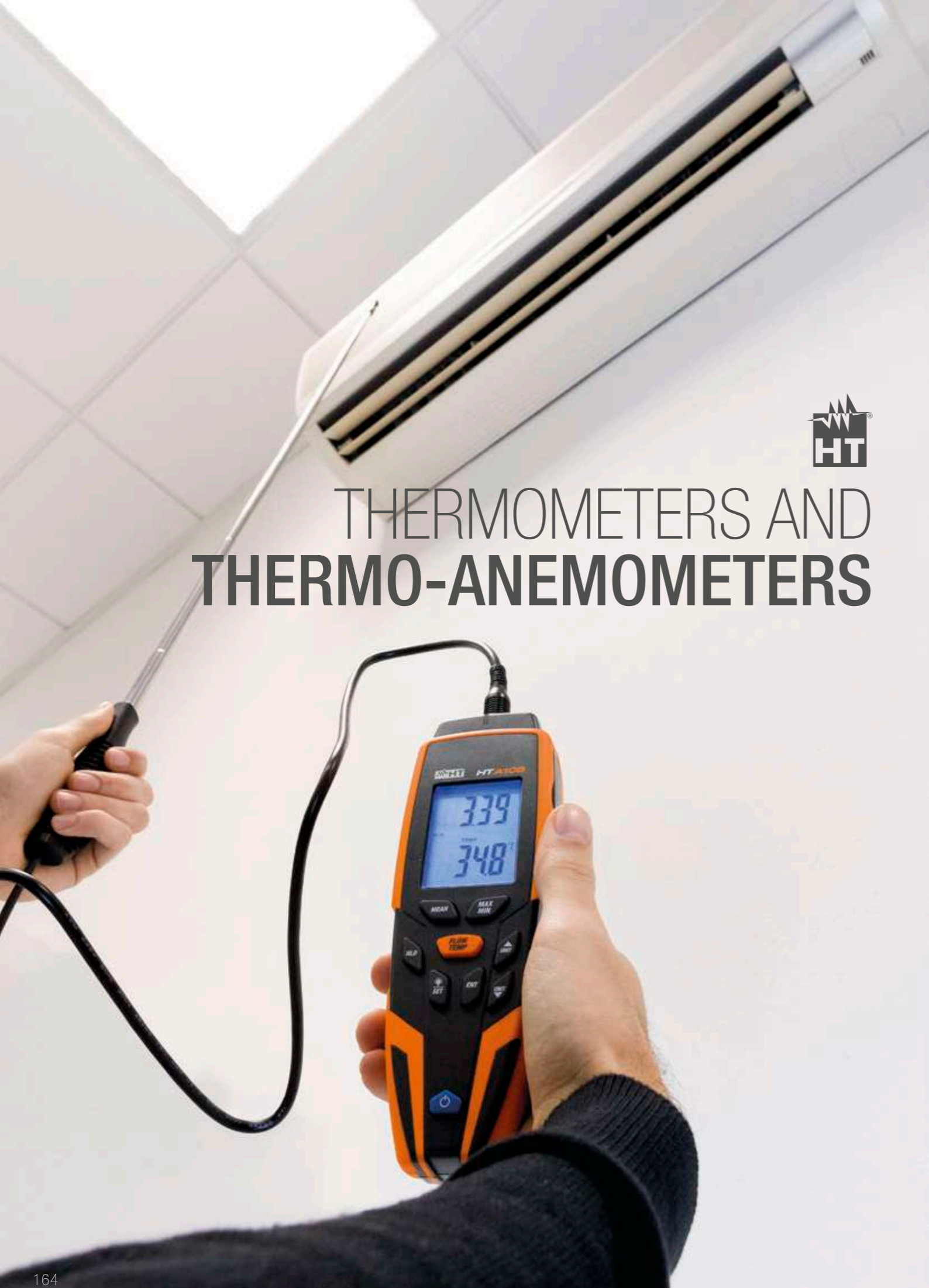

THERMOMETERS AND THERMO-ANEMOMETERS

THERMOMETERS AND THERMO-ANEMOMETERS



MAIN MEASUREMENTS	HTA103	HTA105	HTA106	HTA107	HT3300	DT8806H	DT103S	HT3305
Distance / infrared spot ratio	-	-	-	8:1	12:1	6:1	-	20:1
Infrared temperature measuring range	-	-	-	-50 ÷ 200°C -58 ÷ 392°F	-50 ÷ 380°C -58 ÷ 716°F	32 ÷ 42.5°(Body) 0 ÷ 60°C (Surface)	0 ÷ 50°C 32 ÷ 122°F	-50°C ÷ 1000°C -58°F ÷ 1832°F
Temperature measuring range with K-type probe	-250 ÷ 1372°C -418 ÷ 2502°F	-	-	-	-	-	-	-50°C ÷ 1370°C -58°F ÷ 2498°F
Temperature measurement with K-type probes	• (*)	-	-	-	-	-	-	• (*)
Measurement of volumetric capacity (m3/s) and enthalpy (kW)	-	•	-	-	-	-	-	-
Measurement of air relative humidity in %RH	-	•	•	• (and materials)	-	-	-	-
Measurement of wind speed in m/s	-	• (hot-wire sensor)	-	-	-	-	-	-
Integrated photo-camera (640x480pxl)	-	-	-	-	-	-	-	-
Image saving in JPG format	-	-	-	-	-	-	-	-
Video saving in 3GP format	-	-	-	-	-	-	-	-
Measurement of air temperature/humidity with built-in sensor	-	•	•	•	-	-	-	-
Temperature measurement of dew point and of wet bulb	-	-	•	•	-	-	-	-
Datalogger function for temperature measure recording	-	-	-	-	-	-	-	-
ADDITIONAL CHARACTERISTICS								
Emissivity adjustment of target	-	-	-	Fixed >0.95	Fixed >0.95	Fixed 0.95	Fixed 0.95	0.01 ÷ 1.00
Setting of alarm thresholds on measurements	-	-	-	•	•	•	• (predefined thresholds)	•
Continuous measurement	-	-	-	-	-	-	-	-
Class 2 integrated laser pointer	-	-	-	•	•	-	-	•
Blue LED built-in illuminators for UV function	-	-	-	-	-	-	• LED alarm	-
Internal memory	-	-	-	•	-	•	-	-
SD Card slot for measure saving	-	-	-	-	-	-	-	-
PC connection through USB cable	-	-	-	-	-	-	-	-
Backlight	•	•	•	•	•	•	-	•
Autorange	•	•	•	•	•	•	•	•
Data HOLD	•	•	•	•	•	•	-	•
MAX/MIN/AVG	• (MAX/MIN)	• (MAX/MIN)	• (MAX/MIN)	• (MAX/MIN)	• (MAX/MIN)	-	-	•
Selection of measuring unit	•	•	•	•	• °C \ °F	•	• °C \ °F	• °C \ °F
Low battery indication	•	•	•	•	•	•	•	•
Auto Power OFF	•	•	•	•	•	•	•	•
Power supply	1x9V 6F22	1x9V 6F22	1x9V 6F22	1x9V 6F22	1x9V 6F22	2x1.5V AA	3x1.5V AA	2x1.5V AAA
Size in mm (LxWxH)	185x60x40	185x60x40	185x60x40	185x60x40	136x75x40	149x77x43	107x75x57	180x105x55
Weight in grams (batteries included)	180	180	180	180	140	195	120	240
Order code	HN000103	HN000105	HN000106	HN000107	HA003300	DT8806H	DT103S	HA003305

* With optional TK probes (TK101 is provided).



ORDER CODE **HN000107** | **HN000106** | **HN000105** | **HN000103**

HTA107 | HTA106 | HTA105 | HTA103

MULTIFUNCTION DEVICES FOR MEASURING ENVIRONMENTAL PARAMETERS

The family of devices HTA10x including HTA103, HTA105, HTA106 and HTA107 has been designed for measuring **environmental parameters** such as **temperature**, **humidity** and **air speed**. HTA103 (thermometer) allows measuring **temperature** with the use of JKT thermocouples in the air, in contact and within liquids (with optional probes TK1xx). HTA105 (thermo-anemometer) measures **air speed** with an in-built hot-wire telescopic probe, further to **temperature/humidity** and **air volumetric flow rate**. HTA106 (thermo-hygrometer) measures air **temperature/humidity** with the in-built sensor. HTA107 (multifunction thermo-hygrometer) allows measuring **air humidity** and **contact measurement** on materials with **internal sensors** and with the **provided penetration probe**. This device also allows the **infrared measurement of temperature** and the **calculation of the temperature difference** in order to establish **condensation conditions** on surfaces. Each model is provided with **display backlight** in order to make readings in poorly lit environments easier.



Functions

	HTA107	HTA106	HTA105	HTA103
IR temperature	•	-	-	-
Temperature with KJT probes	-	-	-	•
Air temperature/humidity with in-built probe	•	•	•	-
Contact humidity	•	-	-	-
Air speed with hot-wire sensor	-	-	•	-
Air volumetric flow rate (CMM, CFM)	-	-	•	-
Dew point temperature	•	•	-	-
Wet bulb temperature	-	•	-	-
Data HOLD	-	•	•	•
MAX/MIN	•	•	•	•
Average value	-	-	•	-
Autorange	•	•	•	•
Backlight	•	•	•	•
Internal memory	•	-	-	-
Auto Power OFF	•	•	•	•

Main features

Display: LCD, 4 digits (double display)
Power supply: 1x9V battery type 6F22
Auto Power OFF: after 15 minutes' idling
Internal memory: Max 20 locations (**HTA107**)
Max operating altitude: 2000m

Technical Specifications

	HTA107	HTA106	HTA105	HTA103
Temperature with K-type probe				
Measuring range:	-	-	-	-250°C ÷ 1372°C -418°F ÷ 2502°F
Basic accuracy:	-	-	-	±(1%reading + 0.5°C) ±(1%reading + 0.9°F)
Air temperature / humidity				
Measuring range:	-28°C ÷ 77°C -20°F ÷ 170°F 0%RH ÷ 100%RH	-20°C ÷ 60°C -4°F ÷ 144°F 0%RH ÷ 100%RH	0°C ÷ 50°C 32°F ÷ 122°F 0%RH ÷ 100%RH	-
	6%RH ÷ 100%RH (contatto)	-	-	-
Basic accuracy:	±2°C / ±3.6°F / ±3%RH	±1°C / ±1.8°F / ±3%RH	±1°C / ±1.8°F	-
Infrared temperature (IR)				
Measuring range:	-50°C ÷ 200°C -58°F ÷ 392°F	-	-	-
Basic precision (@ 0 ÷ 50°C):	±1%rdg or 0.6°C	-	-	-
Emissivity:	0.95 (fixed)	-	-	-
Optical resolution:	D:S = 8:1	-	-	-
Air speed				
Measuring range:	-	-	0.10m/s ÷ 20.00m/s	-
Basic accuracy:	-	-	±(5%rdg + 0.03)	-
Resolution:	-	-	0.01m/s	-

ORDER CODE **DT103S**

DT103S

INFRARED THERMOMETER FOR MEASURING FOREHEAD TEMPERATURE WITHOUT CONTACT

DT103S is an automatic infrared thermometer without contact, with a measuring distance between 5 and 15 cm. It is provided with a convenient wall mounting system and a tripod, a display for reading measured temperatures and flashing LEDs to signal possible high temperatures.



Functions

- Automatic measurement of forehead temperature without contact
- Selectable units °C or °F
- Body, Surface and Counter modes available
- Alarm LEDs and sounds when measuring
- Auto power OFF
- Autorange

Technical Specifications

Measuring range:	0°C ÷ 50°C (32°F ÷ 122°F)
Accuracy:	±0.2°C
Response time:	0.5s
Measuring modes:	Body, Surface, Counter
Allowable measuring distance:	5cm ÷ 15cm
Alarm conditions:	visual (LED) and acoustic (buzzer)
Alarm thresholds:	automatic
Display:	LCD, 999 dots
Power supply:	3x1.5V alkaline batteries type AA LR06
External power supply:	100-240V, 50/60Hz / 5V DC, 2A
Auto Power OFF:	after 12 hours' idling
Operating temperature:	10°C ÷ 40°C
Size (L x W x H):	107 x 75 x 57mm
Weight (batteries included):	120g

Provided accessories

- Batteries
- Power supply with USB cable for mains connection
- Screws for wall mounting
- User Manual

Optional accessories

- TRIPOD Adjustable tripod

NEW

ORDER CODE **DT8806H**

DT8806H

INFRARED THERMOSCANNER FOR NON-CONTACT
BODY TEMPERATURE MEASUREMENT

The DT8806H infrared thermoscanner, certified for medical use, is specially designed to measure the frontal body temperature of a person with extreme rapidity and simplicity.



ORDER CODE **HA003305 | HA003300**

HT3305 HT3300

ULTRA-COMPACT INFRARED THERMOMETERS

Handy and extremely practical systems for reading infrared temperature with a laser system, providing visual and audio indications every time the measured value changes. **HT3305** also allows performing temperature measurements with a K-type probe. These models were thought for very quick measurements to detect, with no loss of time, temperature variations.



Functions

- Accurated non-contact forehead temperature measurements
- Selectable °C or °F units
- Selectable Body and Surface modes
- Audible alarm condition on measurements
- Memorization of the last 32 measures
- Automatic Data Hold & Auto power off
- Autorange

Included accessories

Batteries

Transport bag

User manual

Safety conformance

- ASTM E1965-1998
- EN 980: Graphical symbols for use in the labeling of medical devices
- EN 1041: Information supplied by the manufacturer with medical devices
- EN 60601-1: Medical electrical equipment
Part 1: General requirements for safety (IEC: 60601-1:1998)
- EN 60601-1-2: Medical electrical equipment
Part 1-2: General requirements for safety Collateral standard
Electromagnetic compatibility Requirements and test (IEC 60601-1-2:2001)

Main features

Auto Power Off	
Display:	LCD, backlight
Resolution	0.1°C (0.1°F)
Auto Power OFF:	after 5 minutes idling
Dimensions (L x W x H):	149 x 77 x 43 mm
Weight (included batteries)	195g

Technical specifications

Infrared temperature measurement

- Range (Body mode): 32.0°C ÷ 42.5°C / 90.0°F ÷ 108.0°F
- Range (Surface mode): 0°C ÷ 60.0°C / 32.0°F ÷ 140.0°F
- Resolution: 0.1°C/0.1°F
- Basic accuracy Body mode ASTM E1965-1998 (2003):
32 to 35.9°C/93.2 to 96.6°F (±0.3°C/±0.5°F)
36 to 39°C/96.8 to 102.2°F (±0.2°C/±0.4°F)
39 to 42.5°C/102.2 to 108.5°F (±0.3°C/±0.5°F)
- Measuring distance: 5-15cm (2 - 5.9in)
- Response time: 0.5s

Functions

	HT3300	HT3305
Infrared temperature measurement	-50°C ÷ 380°C	-50°C ÷ 1000°C
Built-in laser pointer	•	•
Laser pointer area for an immediate localization of distance/spot	•	•
Automatic reading lock (HOLD)	•	•
Auto Power OFF	•	•
Distance / Spot ratio D:S	12:1	20:1
Temperature measurement with K-type probe	-	•
Adjustment of emissivity	- (>0.95)	•
Measures in °C/°F	•	•
Data HOLD	•	•
MAX, MIN, AVG functions	•	•
Acoustic alarm for values higher than MAX and lower than MIN	•	•
Backlight	•	•
Auto Power OFF	•	•
Ergonomic and ultra-compact design	•	•

Included accessories

Batteries

K-type wire probe (**HT3305**)

Transport bag

User manual

Main features

Laser pointer:	Class 2
Display:	LCD with backlight
Power supply:	1x9V battery type 6F22 (HT3300) 2x1.5V batteries type AAA LR03 (HT3305)
Auto Power OFF:	after 10 seconds' idling
Size (L x W x H):	136×75×40mm (HT3300), 180×105×55mm (HT3305)
Weight (batteries included):	140g (HT3300), 240g (HT3305)

Technical specifications

Infrared temperature measurement

- Measuring range °C: -50°C ÷ 380°C (**HT3300**);
-50°C ÷ 1000°C (**HT3305**)
- Measuring range °F: -58°F ÷ 716°F (**HT3300**);
-58°F ÷ 1832°F (**HT3305**)
- Resolution: 0.1 °C - 0.1 °F
- Basic accuracy: ±1°C or ±1%reading
- Response time: <150ms
- Spectrum response: 8 ÷ 14µm
- D/S ratio: 12:1 (**HT3300**); 20:1 (**HT3305**)
- Emissivity range: 0.95 fixed (**HT3300**); 0.01 ÷ 1.00 (**HT3305**)
- Temperature measurement with K-type probe (**HT3305**)**
- Measuring range °C: -50°C ÷ 1370°C
- Measuring range °F: -58°F ÷ 2498°F
- Resolution: 0.1 °C - 0.1 °F
- Basic accuracy: ±0.5% rdg (only device without probes)
- Response time: <150ms

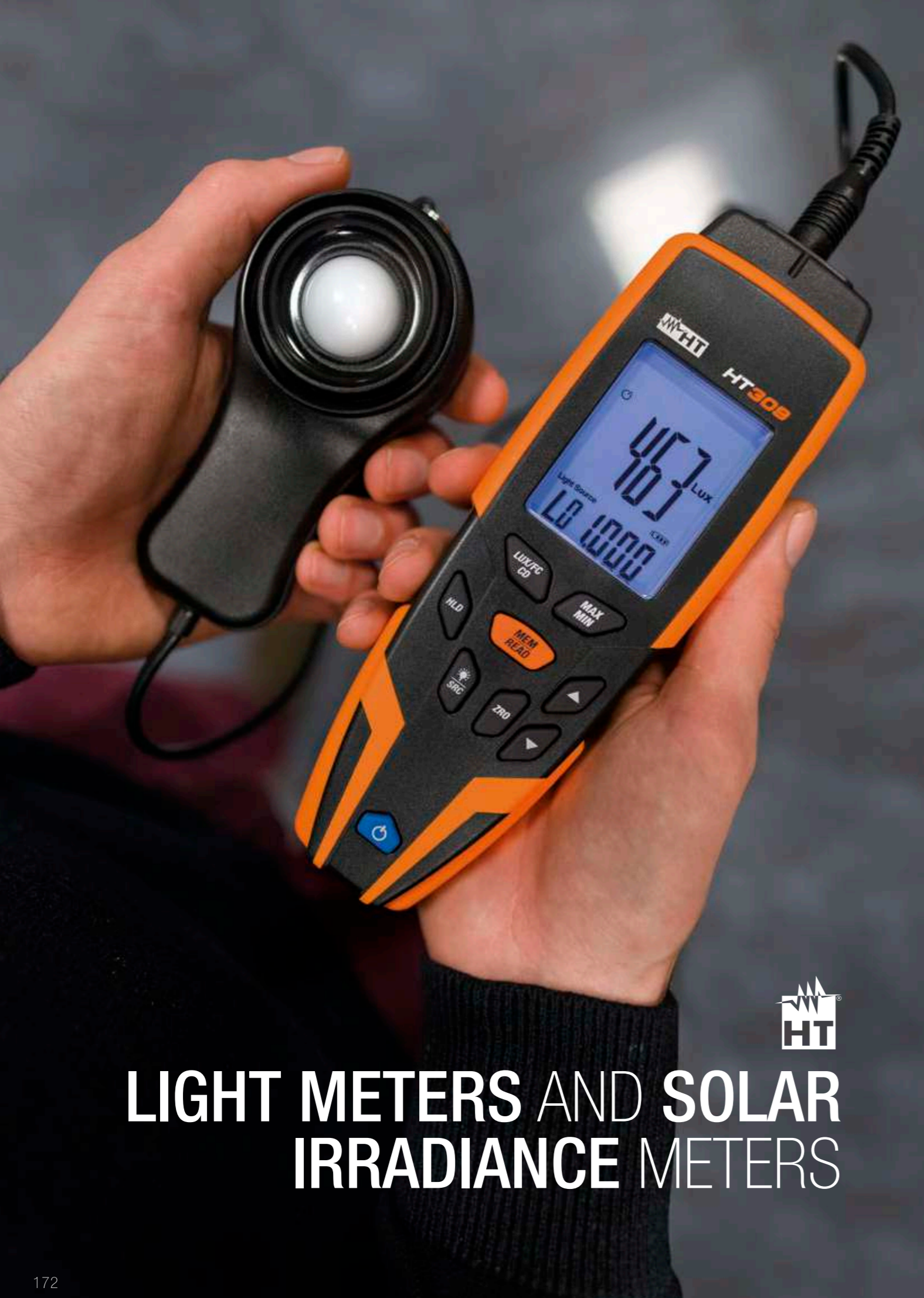

LIGHT METERS AND SOLAR IRRADIANCE METERS



LIGHT METERS AND SOLAR METERS



HT309



HT204

MAIN MEASUREMENTS	LIGHT METERS	SOLAR METERS
	Measuring range	0.01 ÷ 400klux 0.01 ÷ 40kFc
Measurement of illuminance in Lux/Fc	•	-
Measurement of LED sources' illuminance	•	-
Luminous intensity measurement (Cd)	•	-
Solar irradiation measurement W/m ² and BTU/(ft ² *h)	-	•
ADDITIONAL CHARACTERISTICS		
Internal memory for measured data saving	• (Max 99 locations)	-
Zeroing	•	•
Manual measuring range	-	•
Autorange	•	-
Data HOLD	•	•
MAX/MIN/AVG	•	• No AVG
Selection of measuring unit	•	W/m ² - BTU/(ft ² *h)
Auto Power OFF	•	-
Reference standard	Class A JIS C 1609:1993, CNS 5519	-
Power supply	1x 9V	1x 9V
Size (LxWxH) (mm)	185x60x40	130x55x38
Weight (batteries included):	180g	150g
Order code	HA003090	HA000157



ORDER CODE **HA003090**

HT309

MOBILE DIGITAL LIGHT METER

HT309 is a **digital light meter** for measuring illuminance up to **400kLux** through a silicon photodiode sensor. This model also allows measuring **illuminance of LED sources** with **various colours** by setting the **relevant correction factors**, measuring **luminous intensity** (expressed in Candles) and **saving results in the internal memory**.



ORDER CODE **HA000157**

HT204

PORTABLE SOLAR METER

HT204 is a **digital solar irradiance meter** for measurements of **solar irradiation** up to **2000W/m²**, which can be used as an inspection device, typically in **photovoltaic installations**.

Functions and characteristics

- Measuring range of Illuminance (Lux/Fc): 0.01 ÷ 400kLux; 0.01 ÷ 40kFc
- Luminous intensity measurement (Cd)
- Measurement of LED sources' illuminance
- Basic accuracy: ±3%reading
- Zeroing: Digital
- Autorange
- Spectrum response correction
- Data HOLD, MAX/MIN: also AVG
- Internal memory
- Auto Power OFF
- Reference standard: Classe A JIS C 1609:1993 + CNS 5119

Included accessories

- Soft carrying bag
- Test certification
- Battery
- User Manual

Functions and characteristics

- Measuring range: 1 ÷ 1999W/m² 1 ÷ 634 BTU/(ft²*h)
- Resolution: 1W/m² 1BTU/(ft²*h)
- Accuracy: > between 10 W/m² and 5%reading
> between 1BTU/(ft²*h) and 5%reading
- Selection of the measuring unit: W/m² and BTU/(ft²*h)
- Zeroing: Manual with trimmer
- Manual change of scale
- Data HOLD / MAX/MIN

Included accessories

- Transport case
- CE declaration of conformity
- Battery
- User Manual



SOUND LEVEL METERS



SOUND LEVEL METERS



HT157



HT155



HTA102

NEW

	CLASS 1		CLASS 2
Noise measuring range	25 ÷ 140dB	25 ÷ 140dB	30 ÷ 130dB
Noise measurement resolution	0.1 ÷ 0.01dB	0.1dB	0.1dB
Frequency range	10kHz ÷ 20kHz	10kHz ÷ 20kHz	31.5kHz ÷ 8kHz
Dynamic range	90dB	90dB	50dB
Measurement of sound pressure level (SPL)	•	•	•
Measurement of equivalent noise levels (Leq)	•	•	-
Frequency weighting	A/C/Z	A/C/Z	A/C
Integration over time	Fast/Slow/Impulse	Fast/Slow/Impulse	Fast/Slow
Integration with programmable period	•	•	•
Peak measurements (Peak-, Peak+)	•	•	-
Display of MAX/MIN values of SPL	•	•	•
Statistic analysis of noise with "A" weighting	•	•	-
SPL analysis in 24H	•	•	-
Spectrum analysis with octave-band filter (1/1)	• 19Hz ÷ 16kHz	-	-
Spectrum analysis with 1/3 octave-band filter	•	-	-
Mobile calibrator provided	• Class 1	• Class 1	• Class 2
Manual calibration with trimmer	•	•	•
Precise calibration with internal procedure	•	•	-
Pre-polarized "1/2" condenser microphone	•	•	•
AC and DC analogue outputs with 3.5mm jack	• AC only	• AC only	•
Internal memory for data saving	128	128	•
Recalling of results on the display	•	•	-
Mini-USB interface for PC connection	•	•	•
Transfer of saved data onto USB Pen Drive	•	•	-
Windows software for saved data analysis	•	•	•
Display	LCD 240 x 160	LCD 240 x 160	LCD 4 digits
Display backlight	•	•	•
Power supply	4x 1.5V AA	4x 1.5V AA	1x 9V
Provided external power supply	•	•	•
Reference standards	IEC61672 Class 1 IEC61620 Class 1	IEC61672 Class 1	IEC61672 Class 2
Size (LxWxH) (mm)	285x90x39	285x90x39	255x60x40
Weight in grams (batteries included)	500	500	265
Order code	HN000157	HN000155	HN000102

ORDER CODE **HN000155** | **HN000157**

HT155|HT157

DIGITAL INTEGRATING SOUND LEVEL METERS TYPE 1

HT157 and HT155 are mobile integrating sound level meters Type 1 (Class 1) which can be used to monitor the equivalent level of noise (Leq), measure Peak values, check soundproofing levels, acoustic pollution, etc. they are also indicated for certification according to the laws currently in force as regards environmental noise measurements and in working environments. These devices have a wide measuring range (from 25 to 140dB) and multiple functions such as statistic analysis, 24H analysis, integration of Leq over time, which are indispensable elements when measuring. These models also allow carrying out detailed analyses of spectrum components of noise using integrated octave-band filters and 1/3 octave-band filters (only HT157) and they are provided with an internal memory to save data and with a USB interface for transferring data to the PC through dedicated software in a Windows environment with possibility of numerical, graphic and statistic display.

Sound level meters are provided with a practical and resistant case with a mobile calibrator for preliminary checks before each measurement is carried out.



ORDER CODE **HN000102**

HTA102

PROFESSIONAL SOUND LEVEL METER TYPE 2 WITH RECORDING FUNCTION

HTA102 is a professional digital precision sound level meter, the ideal solution to carry out common inspection checks on environmental noise, verification of soundproofing levels, acoustic pollution, etc.

This model allows performing real-time measurements of sound pressure level (SPL) with A/C frequency weighting and integration in Fast/Slow time, and the recording of quantities via PC connection through dedicated software.

Sound level meter HTA102 comes in a practical carrying case with all of the accessories necessary for measurements.



Functions and characteristics

	HT155	HT157
Sound level meter category	Tipo 1	Tipo 1
Noise measuring range	25÷140dB	25÷140dB
Noise measuring resolution	0.0÷10.1dB	0.0÷10.1dB
Dynamic range	> 90dB	> 90dB
Measurement of sound pressure level (SPL)	•	•
Measurement of equivalent noise levels (Leq)	•	•
Frequency weighting	A / C / Z	A / C / Z
Integration over time	F/S/ Impulse	F/S/ Impulse
Peak measurements (Peak-, Peak+)	•	•
Statistic analysis of noise type "A"	•	•
24H analysis of noise	•	•
Octave-band spectrum analysis	-	•
1/3 octave-band spectrum analysis	-	•
1/2 condenser microphone	•	•
Analogue AC output	•	•
Internal calibration in Class 1	•	•
Provided mobile calibrator	•	•
Internal memory for data saving	(128 groups)	(128 groups)
Interface with USB Pen Drive	•	•
USB interface for PC connection	•	•

Main features

Display:	LCD, dot-matrix (240x160pxl) with backlight
External power supply:	Adapter 100-240VAC/5VDC
Internal power supply:	4x1.5V alkaline batteries type AA LR6
Reference standards:	IEC 61672:2002 type1 IEC 61260:1995 type1 (HT157) IEC 60804:1985 type1 IEC 60651:1979 type1DLgs 477/91, 195/06
Size:	285x90x3
Weight (batteries included):	500 g

Included accessories

HT151	Mobile calibrator Class 1
	Power supply 100-240VAC/5VDC with USB output
	Mini-USB/USB cable for PC connection
	USB Pen Drive (TRASCEND JF V30/2GB)
	USB cable for connecting the Pen Drive to the device
	Wind protection 60mm
	Windows software for data transfer
	Transport case
	4x1.5V alkaline batteries type A LR06
	User manual, Calibration certificate of sound level meter and calibrator

Functions and characteristics

- Sound level meter category: Type (Class) 2
- Measuring range: 30 ÷ 130dB
- Noise measurement resolution: 0.1dB
- Dynamic range: 50dB
- Measurement of sound pressure level (SPL)
- A and C frequency weighting
- Integration over time: Fast / Slow
- Display of MAX / MIN values of SPL
- Recording of parameters from software
- 1/2 inch condenser microphone
- Analogue AC and DC outputs (max 1V)
- Manual calibration with trimmer
- **Display: LCD, 4 digits**
- **Power supply: 1x9V batteries type IEC 6F22**
- **Reference standards: IEC 61672 type 2**
- **Size (LxWxH): 255x60x40mm**
- **Weight (batteries included): 265g**

Main features

Wind protection
Screwdriver for manual calibration of sound level meter
Jack for analogue AC/DC outputs
Rigid transport bag
Battery for sound level meter
External power supply 230V AC / 9V DC
Windows software
User manual for sound level meter
1x9V alkaline battery type IEC 6F22
User Manual

LASER METERS



iDM70



DM40

MAIN MEASUREMENTS

Distance measuring range	0,05 ÷ 70m	0,05 ÷ 40m
Measurement of area and volume	•	•
Measurement of heights by indirect method of the Pythagorean theorem	•	•
Measurement of tilt and distance	•	-
Continuous (dynamic) 2-spot and 3-spot measurements	•	•
Partial operations (additions/subtractions) with internal memory	•	•

ADDITIONAL CHARACTERISTICS

Connection to iOS/Android devices through HTLaserMeter App	•	-
Activation of the laser pointer for measurement	•	•
Setting of measuring reference	•	•
Setting of timer for measurements	•	-
Selection of measuring unit	m - ft	m - ft
Backlight	•	•
Air bubble level	•	-
Hole for tripod insertion	•	-
Activation of buzzer upon key pressing	•	-
Auto Power OFF	•	•
Power supply	2x 1.5V AA	2x 1.5V AAA
Size (LxWxH) (mm)	135x53x30	110x48x28
Weight (batteries included)	160g	135g
Order code	HA000700	HA004000



LASER METERS



ORDER CODE **HA000700**

iDM70

LASER DISTANCE METER WITH 70M RANGE, INCLINOMETER AND BLUETOOTH INTERFACE FOR CONNECTION TO IOS AND ANDROID DEVICES



iDM70 is a professional laser distance meter designed for **measuring distances** between two spots in a simple, quick and efficient manner thanks to the integrated laser pointer. Its **small size** makes it a fully mobile device which can be used in any conditions and for any application (**construction, electric, do-it-yourself sector**, etc.) in which it is necessary to measure a linear length. This device also allows **calculating areas and volumes** and carrying out the **indirect measurement of heights** in **2 spots** and **3 spots** with the use of the **trigonometric method** and the mathematical principle of the **Pythagorean theorem**. The **measurement of the tilt** with respect to the horizontal line, a **timer on measurements** and a **small air bubble level** for a **perfect alignment to the targets** are among the available functions. Management of simple operations with the **internal memory** (sums and subtractions) and the presence of the **backlight function** of the display complete the available functions for the device. The HTLaserMeter App is also available **for free** for **iOS** and **Android** and is capable of **connecting in real time** to iDM70 and to carry out **measurements** associated to **pictures** in order to subsequently trace the lines within it.

USE ALL THE POWER OF iDM70

Download free HTLaserMeterBLE APP for iOS and Android devices

Download the free App from [App Store](#) and [Google play](#).

ORDER CODE **HA004000**

DM40

COMPACT LASER DISTANCE METER WITH 40M MEASURING RANGE



DM40 has been designed for **measuring distances** between two spots in a simple, quick and efficient manner thanks to the integrated laser pointer. Its **small size** makes it a fully mobile device that can be used in any conditions and for any application (**construction, electric, do-it-yourself sector**, etc.) in which it is necessary to measure a linear length. This device also allows **calculating areas and volumes** and carrying out the indirect measurement of heights with the use of the mathematical principle of the **Pythagorean theorem**. Management of simple operations with the **internal memory** (sums and subtractions) and the presence of the **backlight function** of the display complete the available functions for the device.

Functions

- Direct measurement of distance from 0.05m to 70m
- Measurement resolution: 0,001m
- Measurement of area and volume
- Measurement of heights by indirect method of the Pythagorean theorem.
- Measurement of tilt and distance
- Continuous (dynamic) 2-spot and 3-spot measurements
- Activation of the laser pointer for measurements
- Setting of measuring reference
- Setting of timer for measurements
- Selection of the measuring unit in "m" o "ft"
- Partial operations (additions/subtractions) with internal memory
- Connection to iOS/Android devices through Bluetooth
- Air bubble level
- Hole for tripod insertion
- Backlight
- Activation of buzzer upon key pressing
- Auto Power OFF

Main features

Power supply:	2x1.5V alkaline batteries type AA LR06
Duration:	max 8000 measurements
Display:	5-digit LCD display with backlight
Memory:	20 locations + external through App
Interface:	Bluetooth™ compatible with iOS - Android
Mechanical protection:	IP54
Laser pointer:	class 2 according to IEC/EN60825-1
Size (LxWxH):	135x53x30mm
Weight (batteries included):	160 kg

Included accessories

- Soft carrying bag, battery and user manual
- User manual HT LaserMeter APP

Functions

- Direct measurement of distance from 0.05m to 40m
- Measurement resolution: 0,001m
- Measurement of area and volume
- Measurement of heights by indirect method of the Pythagorean theorem.
- Continuous (dynamic) measurements
- Activation of the laser pointer for measurements
- Setting of measuring reference
- Selection of the measuring unit in "m" o "ft"
- Partial operations (additions/subtractions) with internal memory
- Backlight
- Auto Power OFF

Main features

Power supply:	2x1.5V alkaline batteries type AAA LR03
Duration:	max 5000 measurements
Display:	5-digit LCD display with backlight
Memory:	20 locations
Mechanical protection:	IP54
Laser pointer:	class 2 according to IEC/EN60825-1
Size (LxWxH):	110x48x28mm
Weight (batteries included):	135 kg

Included accessories

- Soft carrying bag
- Non-slip strap
- Batteries
- User Manual



**PROFESSIONAL
SCISSORS**

SCISSORS

ORDER CODE **HU000743**

F30P

- > New design, even more ergonomic
- > Non-slip gri
- > Blade in reinforced steel
- > Universal crimper for crimp terminals between 1 and 6 mm²
- > Case with safety lock



Just scan the
QR Code
below with your
smrtphone
and watch the
video of **F40**
at work!



ORDER CODE **HU000697**

F40

PROFESSIONAL SCISSORS WITH INTEGRATED
CRIMPER FUNCTION AND CABLE CUTTER 70mm²
+ CRIMPER

- > High-quality scissors with rigid case
- > Blade in reinforced stainless steel
- > Blade width 19mm (0.7")
- > Blade thickness 3.5mm (0.1")
- > Blade for cutting cables up to 70 mm²
- > Crimper function for crimp terminals between 1 and 6 mm², sleeve type
- > Long grip for easy cutting



Lama per taglio cavi fino a 70 mm²



Funzione crimpatrice per capicorda da 1 a 6 mm² a bussola

ORDER CODE **HU000741**

F50

STANDARD SCISSORS WITH CABLE CUTTER
UP TO 50mm² AND CRIMPER FUNCTION

- > Non-slip grip
- > Blade in reinforced steel
- > Universal crimper for crimp terminals between 1 and 6 mm²
- > Case with safety lock
- > Practical hooking system





 **HT ITALIA SRL**

Via della Boaria, 40
48018 Faenza (RA)
ITALIA
Tel. +39 0546 621002
Fax +39 0546 621144
E-mail: export@htitalia.it
ht-instruments.it

 **HT INSTRUMENTS GMBH**

Am Waldfriedhof, 1b
D-41352 Korschenbroich
DEUTSCHLAND
Tel. +49 (0)2161 564 581
Fax +49 (0)2161 564 583
E-mail: info@ht-instruments.de
ht-instruments.de

 **HT INSTRUMENTS SL**

C/ Legalitat, 89
08024 Barcelona
ESPAÑA
Tel. +34 93 4081777
Fax +34 93 4083630
E-mail: info@htinstruments.es
ht-instruments.es

© HT ITALIA 2021 - All rights reserved

The images in this catalogue have a purely illustrative purpose and do not necessarily show the product in its standard version.
The data contained in this catalogue have only an indicative value.
HT ITALIA reserves the right to change them at any time and with no previous notification, in its constant effort to improve its own products.