



eplusLIGHTING

Inspired by light

2023.01



EPLUS LIGHTING

Uma marca 100% portuguesa que surge com a necessidade de criar um leque de soluções Led com características únicas.

A gama EPLUS LIGHTING seleciona os produtos com base nos mais altos padrões de qualidade do mercado.

Cada elemento é escolhido e testado para que cumpra os critérios de utilização intensiva.

A marca pretende dar resposta às principais necessidades do mercado, com o foco em proporcionar a melhor experiência ao utilizador.

Escolha o perfil, a luz, o controlo e transformador que melhor se adequa às suas necessidades.

(ENG) It is a 100% Portuguese brand that arises from the need to create a range of LED solutions with unique characteristics.

The EPLUS LIGHTING range selects products based on the highest quality standards on the market.

Each element is chosen and tested to meet the intensive use criteria.

The brand intends to respond to the main market needs, with a focus on provide the best user experience.

Choose the profile, light, control and transformer that best suits your needs.

(FR) Une marque 100% portugaise qui est née du besoin de créer des solutions Led aux caractéristiques uniques.

La gamme EPLUS LIGHTING sélectionne des produits selon les plus hauts normes de qualité du marché.

Chaque élément est choisi et testé pour répondre aux critères d'utilisation intensive.

La marque prétend en permanence répondre aux principaux besoins du marché et visée offrir la meilleure expérience utilisateur.

Choisissez le profil, la lumière, la commande et le transformateur qui correspondent le mieux à vos besoins.

PROFILES

LED

NEON

SIGN

CONTROL

POWER

ACCESSORIES

ÍNDICE GERAL

(ENG) GENERAL INDEX (FR) SOMMAIRE GENERAL

PROFILES

Introdução EPLUS PROFILES (ENG) Introduction (FR) Introduction 6

Índice EPLUS PROFILES (ENG) Index (FR) Sommaire 7

Simbologia EPLUS PROFILES (ENG) Symbology (FR) Symbologie 8

OUTSIDE

OUT 001 9

OUT 002 10

OUT 003 11

OUT 004 12

OUT 005 13

OUT 006 14

OUT 007 15

OUT 008 16

OUT 009 17

OUT 010 18

OUT 011 19

CORNER

COR 001 21

COR 002 R 22

COR 002 C 23

COR 003 R 24

COR 003 C 25

INSIDE

IN 001 26

IN 002 27

IN 003 28

IN 004 29

IN 005 30

IN 006 31

PROJECT

PRO 001 32

PRO 002 33

PRO 003 34

PRO 004 35

PRO 005 36

PRO 006 37

PRO 007 38

PRO 008 39

PRO 009 40

PRO 010 41

PRO 011 42

PRO 012 43

PRO 013 44

PRO 014 45

PRO 015 46

LED

Introdução EPLUS LED (ENG) Introduction (FR) Introduction 48

Índice EPLUS LED (ENG) Index (FR) Sommaire 49

Simbologia EPLUS LED (ENG) Symbology (FR) Symbologie 50

EFFI

EFFI 30W 51

ECOB

ECOB 15W 52

ECOB 10W 53

EPRO

EPRO 22W 54

EPRO 16.8W 55

EPRO 14.4W 56

EPRO 9.6W 57

EPRO 4.8W 58

EPRO 24W CCT 59

EPRO 19.2W RGB+W 60

EPRO 19.2W RGB+CCT 61

EPRO 19.2W RGB DIGITAL 62

EPRO 14.4W RGB 63

HQS

HQS 14.4W RGB 64

EPRO S

EPRO S 7.2W 65

EPRO S LENS 16W 66

NEON

Introdução EPLUS NEON (ENG) Introduction (FR) Introduction 68

Índice EPLUS NEON (ENG) Index (FR) Sommaire 69

Simbologia EPLUS NEON (ENG) Symbology (FR) Symbologie 70

MINI-CUT

NEON MINI-CUT 11W 71

SMALL

NEON S 9.6W 72

MEDIUM

NEON M 9.6W 73

LARGE

NEON L 9.6W 74

NEON L 14.4W RGB 75

NEON L 14.4W RGB+W 76

SIGN

Introdução EPLUS SIGN (ENG) Introduction (FR) Introduction 78

Índice EPLUS SIGN (ENG) Index (FR) Sommaire 79

Simbologia EPLUS SIGN (ENG) Symbology (FR) Symbologie 80

SIGN 001 0.36W 81

SIGN 001 0.72W 82

SIGN 001 1.08W 83

SIGN 002 32W 84

SIGN 003 5W 85

SIGN 004 1.2W 86

SIGN 005 0.72W 87

SIGN 005 1.2W 87

SIGN 006 0.24W 88

SIGN 006 0.48W 89

SIGN 006 0.72W 90

SIGN 007 1.2W 91

SIGN 008 2W 92

SIGN 009 0.72W RGB DIGITAL 93

SIGN 010 0.72W RGB+W 94

SIGN 011 0.72W RGB 95

SIGN 012 0.72W CCT 96

SIGN 013 0.72W	97	AMP BOX	128	Índice EPLUS ACCESSORIES (ENG) Index (FR) Sommaire	159
SIGN 014 2.5W	98	SWITCH BOX	129	INTERRUPTORES	160 - 161
SIGN NEON	99	DIMMER BOX	130	(ENG) SWITCHES (FR) INTERRUPTEUR	
CONTROL		ACTION BOX S	131	ACESSÓRIOS para fita LED	162 - 165
Introdução EPLUS CONTROL (ENG) Introduction (FR) Introduction	103	PROXI BOX	132	(ENG) ACCESSORIES for led strip (FR) ACCESSORIES pour bande led	
Índice EPLUS CONTROL (ENG) Index (FR) Sommaire	104	PROXI DIMMER	133	LIGAÇÃO	166
Índice EPLUS BLEBOX (ENG) Index (FR) Sommaire	105	PROXI SWITCH	134	(ENG) CONNECTIONS (FR) LIENS	
Simbologia EPLUS CONTROL (ENG) Symbology (FR) Symbologie	106	U REMOTE	135	FIXAÇÃO	167
RECEIVER		S REMOTE	136	(ENG) FIXATION (FR) FIXATION	
RECEIVER 001	107	POWER		FIO PARALELO	168
RECEIVER 002	108	Introdução EPLUS POWER (ENG) Introduction (FR) Introduction	138	(ENG) PARALLEL WIRE (FR) FIL PARALLÈLE	
RECEIVER 003	109	Índice EPLUS LED (ENG) Index (FR) Sommaire	139	EXTENSÕES com FICHA	169
RECEIVER 004	110	Simbologia EPLUS LED (ENG) Symbology (FR) Symbologie	140	(ENG) PARALLEL WIRE (FR) FIL PARALLÈLE	
RECEIVER 005	111	POS		MANGA TERMORETRÁTIL	170
RECEIVER 006	112	POS C2	141	(ENG) THERMORETCHABLE SLEEVE (FR) GAINÉ THERMORÉTRATABLE	
DRIVER		DIN	142	FERROS & FIO de SOLDAR	170
DRIVER 001	113	FTPC S	143	(ENG) SOLDERING IRON & WIRE (FR) FER & FIL À SOUDER	
DRIVER 002	114	FTPC S WP	144	SERVIÇOS	171
DRIVER 003	115	FTPC DA	145	(ENG) SERVICES (FR) PRESTATIONS DE SERVICES	
AMP		FTPC DA WP	146	CONDIÇÕES GERAIS DE VENDA	172
AMP 001	116	FTPC FP	147	(ENG) GENERAL CONDITIONS OF SALE (FR) CONDITIONS GENERALES DE VENTE	
AMP 002	117	GLP			
REMOTE		GPV	148		
REMOTE A CCT	118	GPLSV	149		
REMOTE B RGB+W	119	GTPC S	150		
REMOTE C RGB+CCT	120	GTPC D	151		
REMOTE D	121	MW POWER			
GATEWAY	122	MPL 03	152		
BLEBOX		MPLC 12/16	153		
WLIGHT BOX	124	MPL 06	154		
WLIGHT BOX S	125	MPL 12	155		
WLIGHT BOX 5	126	MPL 16 LC	156		
PIXEL BOX	127	ACCESSORIES			
		Introdução EPLUS ACCESSORIES (ENG) Introduction (FR) Introduction	158		





e⁺ PROFILES

EPLUS PROFILES

é uma seleção de perfilaria
em alumínio para iluminação Led.

Uma gama pensada para que os
arquitetos, projetistas, fabricantes, instaladores e o consumidor
possam encontrar a melhor solução para os seus
projetos de iluminação.

Todos os produtos são fabricados e desenhados para
proporcionar a melhor experiência ao seu utilizador.

Uma gama completa, com todos os acessórios e uma vasta
possibilidade de acabamentos, faz da Eplus PROFILES uma ferramenta
indispensável quando estiver a projetar a iluminação do espaço.

(ENG) EPLUS PROFILES it's a profile selection in aluminum for LED lighting.
A range designed for architects, designers, manufacturers, installers and the
consumer can find the best solution for their lighting projects. All products are
manufactured and designed to provide the best user experience. A complete range,
with all accessories and a wide range of finishes, makes this catalog an
indispensable tool when designing space lighting.

(FR) EPLUS PROFILES est une sélection
de profilés en aluminium pour l'éclairage LED.

Une gamme conçue pour architectes, designers, fabricants, installateurs et le
consommateur peuvent trouver la meilleure solution pour leur
projets d'éclairage. Tous les produits sont fabriqués et conçus pour offrir la
meilleure expérience à l'utilisateur. Une gamme complète, avec tous les accessoires
et une large gamme de finitions, fait de ce catalogue un outil indispensable lors de
la conception de l'éclairage des vous espaces.

PROFILES

OUTSIDE

9 - 13

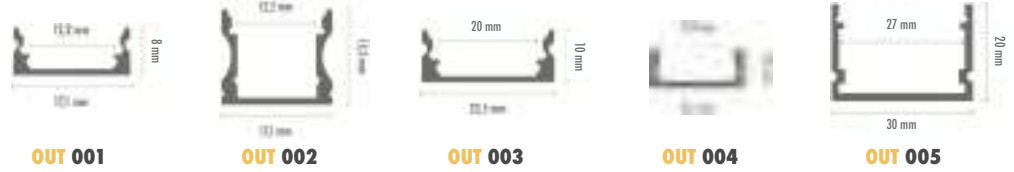

OUTSIDE

14 - 19

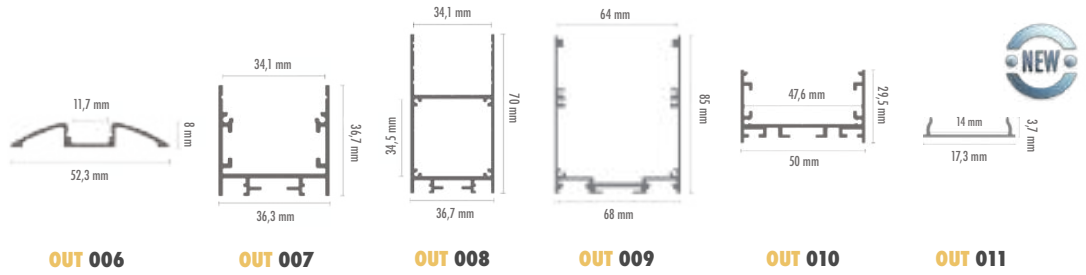

CORNER

21 - 25

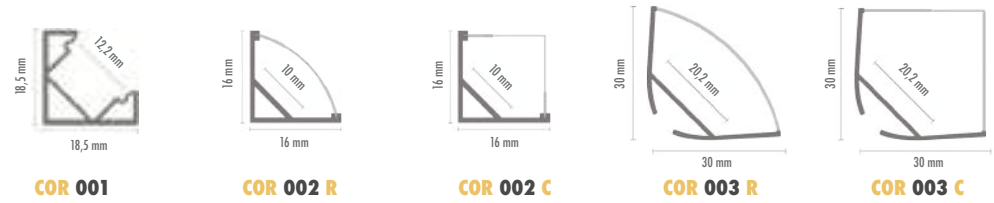

INSIDE

26 - 30

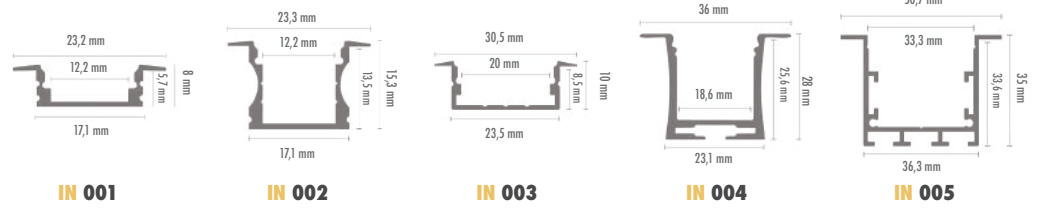

INSIDE

31

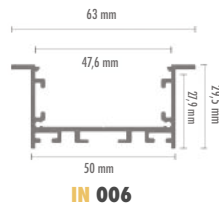

PROJECT

32 - 36



PROJECT

37 - 41

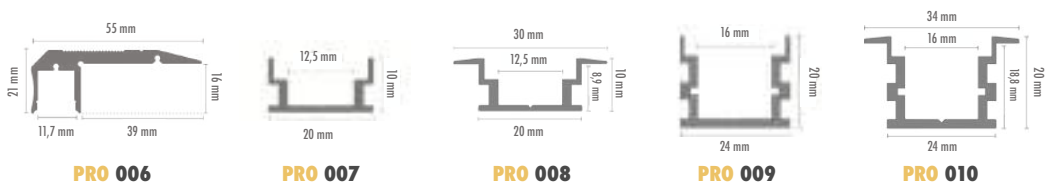

PROJECT

42 - 46

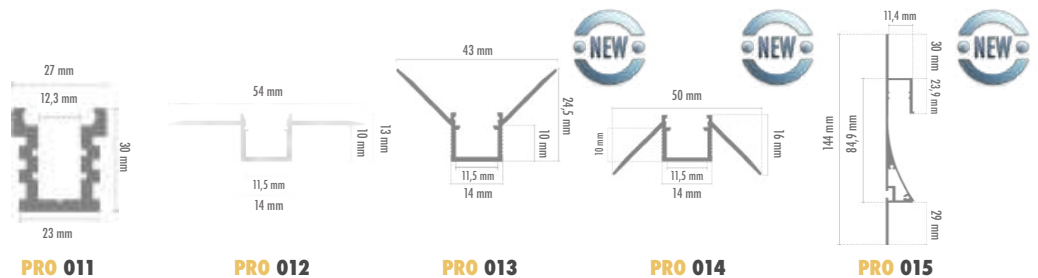

SIMBOLOGIA (ENG) SYMBOLOGY (FR) SYMBOLOGIE

	Encastrar (ENG) Recessed (FR) Encastrer
	Superfície (ENG) Surface (FR) Surface
	Suspenso (ENG) Suspended (FR) Suspendu
	Canto (ENG) Corner (FR) Coin
	Comprimento do perfil (metros) (ENG) Profile length (meters) (FR) Longueur du profil (mètres)
	Potencia Máx. por metro (Watts) (ENG) Max. power per meter (Watts) (FR) Puissance maximale par mètre (Watts)
	Lacagem a cores RAL (ENG) RAL color lacquered (FR) Laquage aux couleurs RAL
	Maleável (ENG) Malleable (FR) Malléable
	Suporta até 1 Tonelada (ENG) Holds up to 1 ton (FR) Supporte jusqu'à 1 tonne
	Corte GRATUITO (ENG) FREE cutting (FR) Coupe GRATUITE
	Certificado RoHS compliant (ENG) RoHS compliant Certificate (FR) Certificat RoHS compliant
	Conformidade com as diretivas legais vigentes na Europa (ENG) Compliance with legal directives in Europe (FR) Conformité aux directives légales en vigueur en Europe
	Impróprio ao lixo comum (ENG) Inappropriate for common garbage (FR) Inapproprié pour les ordures ménagères



OUT 001



Perfil simples para qualquer tipo de aplicação. Muito utilizado em mobiliário e sancas.

(ENG) Simple profile for any type of application. Widely used in furniture and covings leds.

(FR) Profilé simple pour tous types d'applications. Beaucoup utilisé dans les meubles et corniches.

Perfil Profile / Profilé	Referência Reference / Référence	Acabamento Color / Couleur	PVP
	OUT001-A	Anodizado cinzento Grey Anodized / Gris Anodisé	6,14 €
	OUT001-B	Lacado Preto Black Lacquered / Laqué Noir	7,51 €
	OUT001-W	Lacado Branco White Lacquered / Laqué Blanc	7,51 €
	OUT001-RAL	RAL	23,89 €

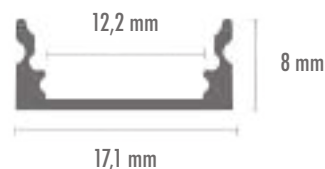

ARTIGOS COMPATÍVEIS COMPATIBLE ARTICLES / ARTICLES COMPATIBLES

Difusores Diffuser / Diffuseur	Referência Reference / Référence	Acabamento Color / Couleur	PVP	Acessórios Accessories / Accessoires	Referência Reference / Référence	Acabamento Color / Couleur	PVP
	DIF-A-OP	Opalino Opaline	3,21 €		END-OUT001-G	Cinzento Grey / Gris	0,50 €
	DIF-A-TR	Transparente Transparent	3,21 €		END-OUT001-B	Preto Black / Noir	0,50 €
	DIF-A-B	Preto Black / Noir	4,65 €		END-OUT001-W	Branco White / Blanc	0,50 €
					CLIP-OUT001	Transparente Transparent	0,50 €



OUT 002



Perfil fundo para uma linha perfeita sem pontos. Ideal para aplicar em mobiliário e projectos de iluminação ambiente ou de trabalho.





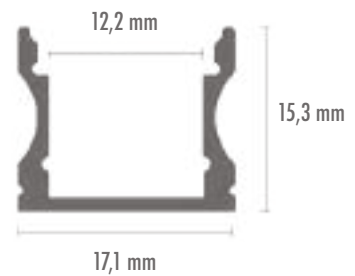

(ENG) Deep profile for a perfect line without dots. Ideal furniture and ambient or work lighting projects.

(FR) Profilé profond, pour obtenir une ligne de lumière parfaite sans points. Idéal pour les meubles et pour les projets d'éclairage ambiant ou de travail.

Perfil Profile / Profilé	Referência Reference / Référence	Acabamento Color / Couleur	PVP
	OUT002-A	Anodizado cinzento Grey Anodized / Gris Anodisé	9,01 €
	OUT002-B	Lacado Preto Black Lacquered / Laqué Noir	10,58 €
	OUT002-W	Lacado Branco White Lacquered / Laqué Blanc	10,58 €
	OUT002-RAL	RAL	33,11 €



ARTIGOS COMPATÍVEIS COMPATIBLE ARTICLES / ARTICLES COMPATIBLES

Difusores Diffuser / Diffuseur	Referência Reference / Référence	Acabamento Color / Couleur	PVP	Acessórios Accessories / Accessoires	Referência Reference / Référence	Acabamento Color / Couleur	PVP
	DIF-A-OP	Opalino Opaline	3,21 €		END-OUT002-G	Cinzento Grey / Gris	0,50 €
	DIF-A-TR	Transparente Transparent	3,21 €		END-OUT002-B	Preto Black / Noir	0,50 €
	DIF-A-B	Preto Black / Noir	4,65 €		END-OUT002-W	Branco White / Blanc	0,50 €
					CLIP-OUT002	Transparente Transparent	0,50 €



OUT 003



Perfil discreto que possibilita a instalação de duas fitas de 8 mm permitindo aumentar a luminosidade ou combinar cores.



(ENG) Discreet profile that allows you to install two 8 mm strips allowing to increase the brightness or combine colors.

(FR) Profilé discret qui permet d'appliquer deux bandes de 8 mm, permettant d'augmenter la luminosité ou de combiner les couleurs.

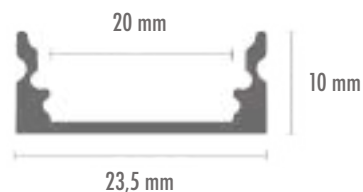
Perfil Profile / Profilé	Referência Reference / Référence	Acabamento Color / Couleur	PVP
	OUT003-A	Anodizado cinzento Grey Anodized / Gris Anodisé	11,25 €
	OUT003-B	Lacado Preto Black Lacquered / Laqué Noir	14,96 €
	OUT003-W	Lacado Branco White Lacquered / Laqué Blanc	14,96 €
	OUT003-RAL	RAL	37,12 €



ARTIGOS COMPATÍVEIS COMPATIBLE ARTICLES / ARTICLES COMPATIBLES

Difusores Diffuser / Diffuseur	Referência Reference / Référence	Acabamento Color / Couleur	PVP
	DIF-B-OP	Opalino Opaline	4,78 €
	DIF-B-TR	Transparente Transparent	4,78 €
	DIF-B-B	Preto Black / Noir	6,00 €

Accessórios Accessories / Accessoires	Referência Reference / Référence	Acabamento Color / Couleur	PVP
	END-OUT003-G	Cinzento Grey / Gris	0,50 €
	END-OUT003-B	Preto Black / Noir	0,50 €
	END-OUT003-W	Branco White / Blanc	0,50 €
	CLIP-OUT003	Transparente Transparent	0,50 €



OUT 004



Perfil económico para suporte de fita e dissipação de calor. Pode instalar fitas até 10mm de largura.

(ENG) Economical profile, for led strip support and heat dissipation. You can install LEDs strips up to 10mm wide.

(FR) Profilé économique, pour le support de la bande LED et la dissipation thermique. Vous pouvez appliquer des bandes LEDs jusqu'à 10 mm de large.

Perfil Profile / Profilé	Referência Reference / Référence	Acabamento Color / Couleur	PVP
	OUT004-A	Anodizado cinzento Grey Anodized / Gris Anodisé	5,30 €
	OUT004-RAL	RAL	24,58 €

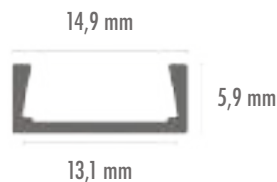

ARTIGOS COMPATÍVEIS COMPATIBLE ARTICLES / ARTICLES COMPATIBLES

Difusores Diffuser / Diffuseur	Referência Reference / Référence	Acabamento Color / Couleur	PVP	Accessórios Accessories / Accessoires	Referência Reference / Référence	Acabamento Color / Couleur	PVP
	DIF-C-OP	Opalino Opaline	3,27 €		END-OUT004-G	Cinzento Grey / Gris	0,50 €
					CLIP-OUT004	Cinzento Grey / Gris	0,50 €



OUT 005



Perfil que permite criar linhas de luz com maior luminosidade para o seu ambiente ou local de trabalho, mantendo a harmonia com o espaço.

(ENG) Profile that allows you to create lines of light with greater luminosity for your environment or work place, maintaining harmony with the space.

(FR) Ce Profilé vous permet de créer des lignes de lumières avec plus luminosité pour votre environnement, en gardant l'harmonie avec le lieu.

Perfil Profile / Profilé	Referência Reference / Référence	Acabamento Color / Couleur	PVP
-----------------------------	-------------------------------------	-------------------------------	-----

	OUT005-A	Anodizado cinzento Grey Anodized / Gris Anodisé	18,11 €
	OUT005-B	Lacado Preto Black Lacquered / Laqué Noir	19,20 €
	OUT005-W	Lacado Branco White Lacquered / Laqué Blanc	19,20 €
	OUT005-RAL	RAL	40,27 €

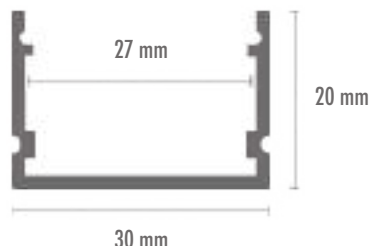

ARTIGOS COMPATÍVEIS COMPATIBLE ARTICLES / ARTICLES COMPATIBLES

Difusores Diffuser / Diffuseur	Referência Reference / Référence	Acabamento Color / Couleur	PVP
-----------------------------------	-------------------------------------	-------------------------------	-----

	DIF-E-OP	Opalino Opaline	5,37 €
-------------------------------------------------------------------------------------	----------	--------------------	--------

Accessórios Accessories / Accessoires	Referência Reference / Référence	Acabamento Color / Couleur	PVP
------------------------------------------	-------------------------------------	-------------------------------	-----

	END-OUT005-G	Cinzento Grey / Gris	0,50 €
	END-OUT005-B	Preto Black / Noir	0,50 €
	END-OUT005-W	Branco White / Blanc	0,50 €
	CLIP-OUT005	Cinzento Grey / Gris	0,50 €
	SUSPKIT	Cinzento Grey / Gris	8,00 €



OUT 006







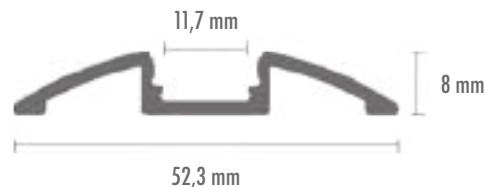

Perfil que permite a passagem de fios no interior. Solução indicada para locais onde não pode fazer alterações ao existente.
 (ENG) Profile that allows the passage of wires inside. Solution indicated for places where you cannot make changes to the existing one.
 (FR) Ce Profilé permet le passage des fils à l'intérieur. Solution adéquat pour les endroits où vous ne pouvez pas apporter de modifications à l'existant.

Perfil Profile / Profilé	Referência Reference / Référence	Acabamento Color / Couleur	PVP
	OUT006-A	Anodizado cinzento Grey Anodized / Gris Anodisé	15,75 €
	OUT006-B	Lacado Preto Black Lacquered / Laqué Noir	18,90 €
	OUT006-W	Lacado Branco White Lacquered / Laqué Blanc	18,90 €
	OUT006-RAL	RAL	37,54 €



ARTIGOS COMPATÍVEIS COMPATIBLE ARTICLES / ARTICLES COMPATIBLES

Difusores Diffuser / Diffuseur	Referência Reference / Référence	Acabamento Color / Couleur	PVP	Acessórios Accessories / Accessoires	Referência Reference / Référence	Acabamento Color / Couleur	PVP
	DIF-A-OP	Opalino Opaline	3,21 €		END-OUT006-G	Cinzento Grey / Gris	0,50 €
	DIF-A-TR	Transparente Transparent	3,21 €		END-OUT006-B	Preto Black / Noir	0,50 €
	DIF-A-B	Preto Black / Noir	4,65 €		END-OUT006-W	Branco White / Blanc	0,50 €
					CLIP-OUT006	Transparente Transparent	0,50 €



OUT 007



Perfil robusto, ideal para criar luminárias fixas, suspensas ou encastradas. O seu interior permite levar até quatro fitas de 8mm, indicado para locais de lazer ou de trabalho.

(ENG) Robust profile, ideal for creating fixed, suspended or recessed luminaires. Its interior allows you to carry up to four 8mm tapes, suitable for leisure or work places..





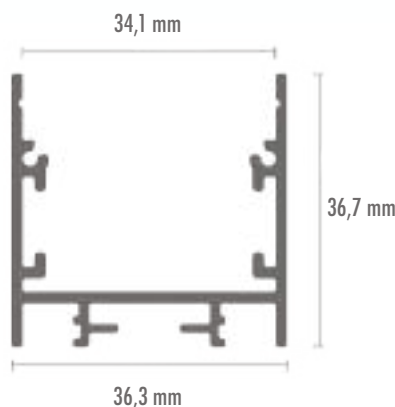



(FR) Profilé robuste, idéal pour créer des luminaires fixes, en suspend ou encastrer. Son intérieur vous permet d'appliquer jusqu'à quatre bandes de 8 mm, adapter aux lieux de loisirs ou de travail.

Perfil Profile / Profilé	Referência Reference / Référence	Acabamento Color / Couleur	PVP
	OUT007-A	Anodizado cinzento Grey Anodized / Gris Anodisé	39,66 €
	OUT007-W	Lacado Branco White Lacquered / Laqué Blanc	45,76 €
	OUT007-RAL	RAL	67,28 €



ARTIGOS COMPATÍVEIS COMPATIBLE ARTICLES / ARTICLES COMPATIBLES

Difusores Diffuser / Diffuseur	Referência Reference / Référence	Acabamento Color / Couleur	PVP
	DIF-F-OP DIF-F-OP-6M	Opalino Opaline	2m - 10,24 € 6m - 30,72 €

Accessórios Accessories / Accessoires	Referência Reference / Référence	Acabamento Color / Couleur	PVP
	END-OUT010-G	Cinzento Grey / Gris	1,00 €
	END-OUT010-W	Branco White / Blanc	1,00 €
	CLIP-OUT010	Cinzento Grey / Gris	4,50 €
	SUSPKIT	Cinzento Grey / Gris	8,00 €
	UNI-7	Cinzento Grey / Gris	2,85 €
	UNI-15	Cinzento Grey / Gris	2,85 €
	UNI90-7	Cinzento Grey / Gris	3,60 €
	UNI90-15	Cinzento Grey / Gris	3,60 €





OUT 008



Perfil que permite instalar uma fonte de alimentação e controlador no seu interior, poupando espaço e trabalho. Ideal para luminárias fixas ou suspensas.

(ENG) Profile that allows you to install a power supply and controller inside, saving space and work. Ideal for fixed or suspended.

(FR) Ce Profilé vous permet d'installer une source d'alimentation et le contrôleur à l'intérieur, économisant de l'espace et du travail. Idéal pour les luminaires fixes ou en suspend.

Perfil Profile / Profilé	Referência Reference / Référence	Acabamento Color / Couleur	PVP
-----------------------------	-------------------------------------	-------------------------------	-----



OUT008-A	Anodizado cinzento Grey Anodized / Gris Anodisé	61,35 €
OUT008-B	Lacado Preto Black Lacquered / Laqué Noir	79,73 €
OUT008-W	Lacado Branco White Lacquered / Laqué Blanc	79,73 €
OUT008-RAL	RAL	82,23 €

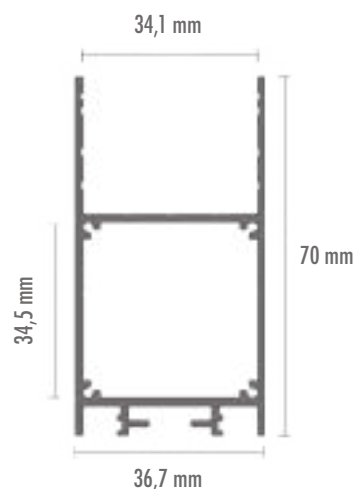

ARTIGOS COMPATÍVEIS COMPATIBLE ARTICLES / ARTICLES COMPATIBLES

Difusores Diffuser / Diffuseur	Referência Reference / Référence	Acabamento Color / Couleur	PVP
-----------------------------------	-------------------------------------	-------------------------------	-----



DIF-F-OP	Opalino	2m - 10,24 €
DIF-F-OP-6M	Opaline	6m - 30,72 €

Accessories / Accessoires	Referência Reference / Référence	Acabamento Color / Couleur	PVP
---------------------------	-------------------------------------	-------------------------------	-----



END-OUT008-G	Cinzento Grey / Gris	1,00 €
END-OUT008-B	Preto Black / Noir	1,00 €
END-OUT008-W	Branco White / Blanc	1,00 €
CLIP-OUT008	Cinzento Grey / Gris	4,50 €
SUSPKIT	Cinzento Grey / Gris	8,00 €
UNI-7	Cinzento Grey / Gris	2,85 €
UNI-15	Cinzento Grey / Gris	2,85 €
UNI90-7	Cinzento Grey / Gris	3,60 €
UNI90-15	Cinzento Grey / Gris	3,60 €



OUT 009



Perfil para instalações mais exigentes. Permite uma iluminação nos dois sentidos (direta e indireta), a colocação da alimentação e o controlador no interior. Ideal para locais de trabalho ou de exposição.

(ENG) Profile for more demanding installations. It allows lighting in both directions (direct and indirect), the placement of the power supply and the controller inside. Ideal for work or exhibition places.

(FR) Profilé pour des installations plus exigeantes. Permet un éclairage bidirectionnel (direct et indirect), avec placement pour la source de l'alimentation et le contrôleur à l'intérieur. Idéal pour les lieux de travail ou d'exposition.

Perfil Profile / Profilé	Referência Reference / Référence	Acabamento Color / Couleur	PVP
-----------------------------	-------------------------------------	-------------------------------	-----



OUT009-A	Anodizado cinzento Grey Anodized / Gris Anodisé	109,62 €
OUT009-B	Lacado Preto Black Lacquered / Laqué Noir	139,23 €
OUT009-W	Lacado Branco White Lacquered / Laqué Blanc	139,23 €
OUT009-RAL	RAL	155,25 €

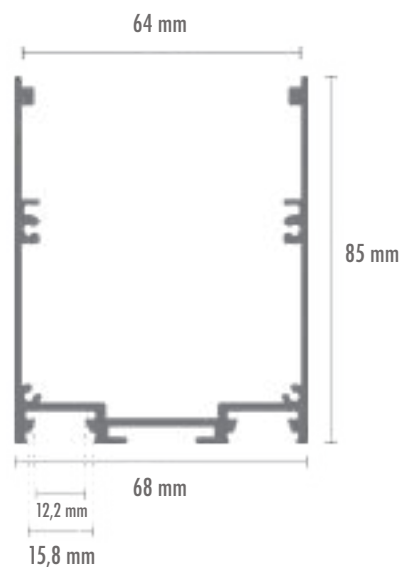

ARTIGOS COMPATÍVEIS
COMPATIBLE ARTICLES / ARTICLES COMPATIBLES

Difusores Diffuser / Diffuseur	Referência Reference / Référence	Acabamento Color / Couleur	PVP
-----------------------------------	-------------------------------------	-------------------------------	-----



DIF-H-OP DIF-H-OP-6M	Opalino Opaline	2m - 14,33 € 6m - 42,99 €
DIF-C-OP	Opalino Opaline	2m - 3,27 €

Accessories Accessories / Accessoires	Referência Reference / Référence	Acabamento Color / Couleur	PVP
------------------------------------------	-------------------------------------	-------------------------------	-----



END-OUT009-G	Cinzento Grey / Gris	1,00 €
END-OUT009-B	Preto Black / Noir	1,00 €
END-OUT009-W	Branco White / Blanc	1,00 €
CLIP-OUT009	Cinzento Grey / Gris	4,50 €
SUSPKIT	Cinzento Grey / Gris	8,00 €
UNI-25	Cinzento Grey / Gris	2,85 €
UNI90-25	Cinzento Grey / Gris	3,60 €



OUT 010







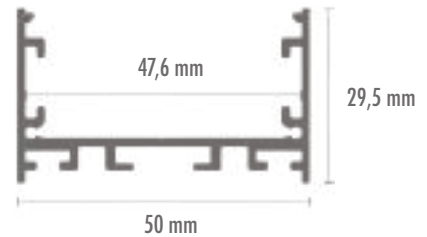

Perfil largo para instalações mais exigentes. Solução indicada para locais com maior necessidade de luz.
 (ENG) Wide profile for more challenging installations. Solution indicated for places with greater need for light.
 (FR) Profilé large pour des installations plus exigeantes. Solution adéquat pour les endroits avec un plus grand besoin de lumière.

Perfil Profile / Profilé	Referência Reference / Référence	Acabamento Color / Couleur	PVP
	OUT010-A	Anodizado cinzento Grey Anodized / Gris Anodisé	37,69 €
	OUT010-W	Lacado Branco White Lacquered / Laqué Blanc	51,20 €
	OUT010-RAL	RAL	67,50 €



ARTIGOS COMPATÍVEIS COMPATIBLE ARTICLES / ARTICLES COMPATIBLES

Difusores Diffuser / Diffuseur	Referência Reference / Référence	Acabamento Color / Couleur	PVP	Accessórios Accessories / Accessoires	Referência Reference / Référence	Acabamento Color / Couleur	PVP
	DIF-G-OP	Opalino Opaline	2m - 12,48 €		END-OUT010-G	Cinzento Grey / Gris	1,00 €
	DIF-G-OP-6M		6m - 37,44 €		END-OUT010-W	Branco White / Blanc	1,00 €
					CLIP-OUT010	Cinzento Grey / Gris	4,50 €
					SUSPKIT	Cinzento Grey / Gris	8,00 €
					UNI-15	Cinzento Grey / Gris	2,85 €
					UNI190-15	Cinzento Grey / Gris	2,60 €



OUT 011



Solução de perfil maleável que se ajusta às curvas da instalação. Perfil de fácil manuseamento para aplicações difíceis.
 (ENG) Flexible profile solution that adjusts to the curves of the installation. Easy handling profile for tough applications.
 (FR) Solution de profil flexible qui s'adapte aux courbes de l'installation. Profil de manipulation facile pour les applications difficiles.

Perfil Profile / Profilé	Referência Reference / Référence	Acabamento Color / Couleur	PVP
	OUT011-A	Anodizado cinzento Grey Anodized / Gris Anodisé	7 €

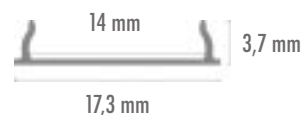

ARTIGOS COMPATÍVEIS COMPATIBLE ARTICLES / ARTICLES COMPATIBLES

Difusores Diffuser / Diffuseur	Referência Reference / Référence	Acabamento Color / Couleur	PVP	Acessórios Accessories / Accessoires	Referência Reference / Référence	Acabamento Color / Couleur	PVP
	DIF-T-OP	Opalino Opaline	3,50 €		END-OUT011-G	Cinzento Grey / Gris	0,50 €
					CLIP-OUT011	Cinzento Grey / Gris	0,50 €







COR 001



Perfil de canto para qualquer tipo de aplicação. Permite a passagem de fios no interior.





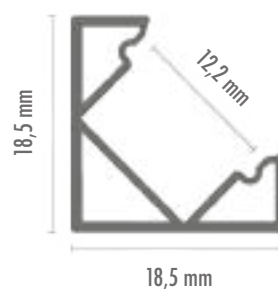

(ENG) Corner profile for any type of application. It allows the passage of wires inside.

(FR) Profilé d'angle pour tous les types d'applications. Il permet le passage des fils à l'intérieur.

Perfil Profile / Profilé	Referência Reference / Référence	Acabamento Color / Couleur	PVP
	COR001-A	Anodizado cinzento Grey Anodized / Gris Anodisé	8,87 €
	COR001-B	Lacado Preto Black Lacquered / Laqué Noir	10,37 €
	COR001-W	Lacado Branco White Lacquered / Laqué Blanc	10,37 €
	COR001-RAL	RAL	29,35 €



ARTIGOS COMPATÍVEIS COMPATIBLE ARTICLES / ARTICLES COMPATIBLES





Difusores Diffuser / Diffuseur	Referência Reference / Référence	Acabamento Color / Couleur	PVP	Acessórios Accessories / Accessoires	Referência Reference / Référence	Acabamento Color / Couleur	PVP
	DIF-A-OP	Opalino Opaline	3,21 €		END-COR001-G	Cinzento Grey / Gris	0,50 €
	DIF-A-TR	Transparente Transparent	3,21 €		END-COR001-B	Preto Black / Noir	0,50 €
	DIF-A-B	Preto Black / Noir	4,65 €		END-COR001-W	Branco White / Blanc	0,50 €
					CLIP-COR001	Cinzento Grey / Gris	0,50 €



COR 002 R







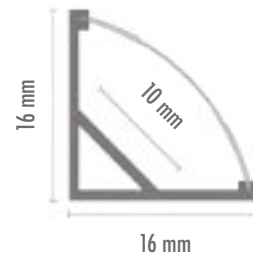

Perfil simples com toda a frente iluminada. Com esta solução apenas verá uma linha contínua de luz.
 (ENG) Simple profile with the entire front illuminated. With this solution you will only see a continuous line of light.
 (FR) Profilé simple avec toute la façade éclairée. Avec cette solution, vous ne verrez qu'une ligne continue de lumière.

Perfil Profile / Profilé	Referência Reference / Référence	Acabamento Color / Couleur	PVP
	COR002-A	Anodizado cinzento Grey Anodized / Gris Anodisé	7,16 €
	COR002-B	Lacado Preto Black Lacquered / Laqué Noir	9,60 €
	COR002-W	Lacado Branco White Lacquered / Laqué Blanc	9,60 €
	COR002-RAL	RAL	27,09 €



ARTIGOS COMPATÍVEIS
 COMPATIBLE ARTICLES / ARTICLES COMPATIBLES

Difusores Diffuser / Diffuseur	Referência Reference / Référence	Acabamento Color / Couleur	PVP	Acessórios Accessories / Accessoires	Referência Reference / Référence	Acabamento Color / Couleur	PVP
	DIF-I-OP-R	Opalino Opaline	3,20 €		END-COR002-G-R	Cinzento Grey / Gris	0,50 €
	DIF-I-TR-R	Transparente Transparent	3,20 €		END-COR002-B-R	Preto Black / Noir	0,50 €
	DIF-I-B-R	Preto Black / Noir	4,80 €		END-COR002-W-R	Branco White / Blanc	0,50 €
					CLIP-COR002	Cinzento Grey / Gris	0,50 €



COR 002 C







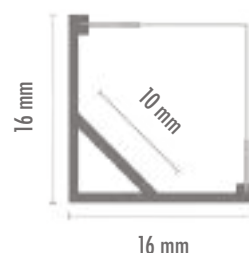

Perfil simples com toda a frente iluminada. Com esta solução apenas verá uma linha contínua de luz.
 (ENG) Simple profile with the entire front illuminated. With this solution you will only see a continuous line of light.
 (FR) Profilé simple avec toute la façade éclairée. Avec cette solution, vous ne verrez qu'une ligne continue de lumière.

Perfil Profile / Profilé	Referência Reference / Référence	Acabamento Color / Couleur	PVP
	COR002-A	Anodizado cinzento Grey Anodized / Gris Anodisé	7,16 €
	COR002-B	Lacado Preto Black Lacquered / Laqué Noir	9,60 €
	COR002-W	Lacado Branco White Lacquered / Laqué Blanc	9,60 €
	COR002-RAL	RAL	27,09 €



ARTIGOS COMPATÍVEIS COMPATIBLE ARTICLES / ARTICLES COMPATIBLES

Difusores Diffuser / Diffuseur	Referência Reference / Référence	Acabamento Color / Couleur	PVP	Acessórios Accessories / Accessoires	Referência Reference / Référence	Acabamento Color / Couleur	PVP
	DIF-I-OP-C	Opalino Opaline	4 €		END-COR002-G-C	Cinzento Grey / Gris	0,50 €
	DIF-I-TR-C	Transparente Transparent	4 €		END-COR002-B-C	Preto Black / Noir	0,50 €
	DIF-I-B-C	Preto Black / Noir	5,20 €		END-COR002-W-C	Branco White / Blanc	0,50 €
					CLIP-COR002	Cinzento Grey / Gris	0,50 €



COR 003 R







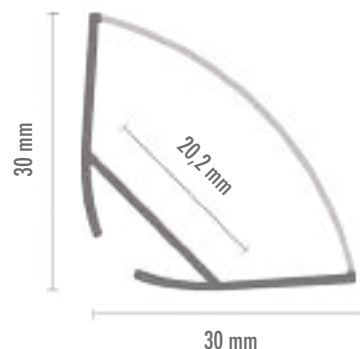

Perfil largo. Sem alumínio à vista, após aceso apenas verá uma linha contínua de luz.
 (ENG) Wide profile. With no aluminum in sight, once lit, you will only see a continuous line of light.
 (FR) Profilé large. Sans aluminium à vue, une fois allumé, vous ne verrez qu'une ligne continue de lumière.

Perfil Profile / Profilé	Referência Reference / Référence	Acabamento Color / Couleur	PVP
	COR003-A	Anodizado cinzento Grey Anodized / Gris Anodisé	13,25 €
	COR003-B	Lacado Preto Black Lacquered / Laqué Noir	18,96 €
	COR003-W	Lacado Branco White Lacquered / Laqué Blanc	18,96 €
	COR003-RAL	RAL	40,64 €



ARTIGOS COMPATÍVEIS
 COMPATIBLE ARTICLES / ARTICLES COMPATIBLES



Difusores Diffuser / Diffuseur	Referência Reference / Référence	Acabamento Color / Couleur	PVP	Acessórios Accessories / Accessoires	Referência Reference / Référence	Acabamento Color / Couleur	PVP
	DIF-J-OP-R	Opalino Opaline	6,99 €		END-COR003-G-R	Cinzento Grey / Gris	0,50 €
	DIF-J-TR-R	Transparente Transparent	6,99 €		END-COR003-B-R	Preto Black / Noir	0,50 €
	DIF-J-B-R	Preto Black / Noir	8,72€		END-COR003-W-R	Branco White / Blanc	0,50 €
					CLIP-COR003	Cinzento Grey / Gris	0,50 €



COR 003 C







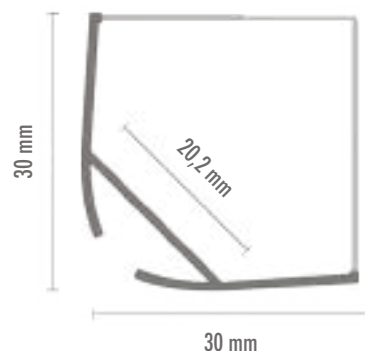

Perfil largo. Sem alumínio à vista, após aceso apenas verá uma linha contínua de luz.
 (ENG) Wide profile. With no aluminum in sight, once lit, you will only see a continuous line of light.
 (FR) Profilé large. Sans aluminium à vue, une fois allumé, vous ne verrez qu'une ligne continue de lumière.

Perfil Profile / Profilé	Referência Reference / Référence	Acabamento Color / Couleur	PVP
	COR003-A	Anodizado cinzento Grey Anodized / Gris Anodisé	13,25 €
	COR003-B	Lacado Preto Black Lacquered / Laqué Noir	18,96 €
	COR003-W	Lacado Branco White Lacquered / Laqué Blanc	18,96 €
	COR003-RAL	RAL	40,64 €



ARTIGOS COMPATÍVEIS COMPATIBLE ARTICLES / ARTICLES COMPATIBLES

Difusores Diffuser / Diffuseur	Referência Reference / Référence	Acabamento Color / Couleur	PVP	Accessórios Accessories / Accessoires	Referência Reference / Référence	Acabamento Color / Couleur	PVP
	DIF-J-OP-C	Opalino Opaline	6,99 €		END-COR003-G-C	Cinzento Grey / Gris	0,50 €
	DIF-J-TR-C	Transparente Transparent	6,99 €		END-COR003-B-C	Preto Black / Noir	0,50 €
	DIF-J-B-C	Preto Black / Noir	8,72€		END-COR003-W-C	Branco White / Blanc	0,50 €
					CLIP-COR003	Cinzento Grey / Gris	0,50 €







IN 001



Perfil para encastrar, com vários acabamentos disponíveis. Com apenas 7mm de profundidade, é ideal para mobiliário.





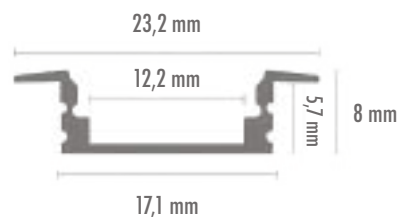

(ENG) Recessed profile, with various finishes available. With only 7 mm in depth, it is ideal for furniture.

(FR) Profilé d'encastrement, avec plusieurs sorts des finitions disponibles. Avec seulement 7 mm de profondeur, il est idéal pour les meubles.

Perfil Profile / Profilé	Referência Reference / Référence	Acabamento Color / Couleur	PVP
	IN001-A	Anodizado cinzento Grey Anodized / Gris Anodisé	6,14 €
	IN001-B	Lacado Preto Black Lacquered / Laqué Noir	7,85 €
	IN001-W	Lacado Branco White Lacquered / Laqué Blanc	7,85 €
	IN001-RAL	RAL	24,94 €



ARTIGOS COMPATÍVEIS COMPATIBLE ARTICLES / ARTICLES COMPATIBLES

Difusores Diffuser / Diffuseur	Referência Reference / Référence	Acabamento Color / Couleur	PVP	Accessórios Accessories / Accessoires	Referência Reference / Référence	Acabamento Color / Couleur	PVP
	DIF-A-OP	Opalino Opaline	3,21 €		END-IN001-G	Cinzento Grey / Gris	0,50 €
	DIF-A-TR	Transparente Transparent	3,21 €		END-IN001-B	Preto Black / Noir	0,50 €
	DIF-A-B	Preto Black / Noir	4,65 €		END-IN001-W	Branco White / Blanc	0,50 €



IN 002



Perfil de encastrar robusto para criar linhas de luz uniformes, sem pontos visíveis, com qualquer fita LED até 12 mm de largura.

(ENG) Robust profile to embed and create the uniform light lines, without visible dots, with any LED strip up to 12 mm wide.

(FR) Profilé robuste à encastrer, indiquée pour créer des lignes de lumière uniformes, sans points visibles, avec n'importe quelle bande LED jusqu'à 12 mm de large.

Perfil Profile / Profilé	Referência Reference / Référence	Acabamento Color / Couleur	PVP
-----------------------------	-------------------------------------	-------------------------------	-----

	IN002-A	Anodizado cinzento Grey Anodized / Gris Anodisé	9,56 €
	IN002-B	Lacado Preto Black Lacquered / Laqué Noir	11,67 €
	IN002-W	Lacado Branco White Lacquered / Laqué Blanc	11,67 €
	IN002-RAL	RAL	30,71 €

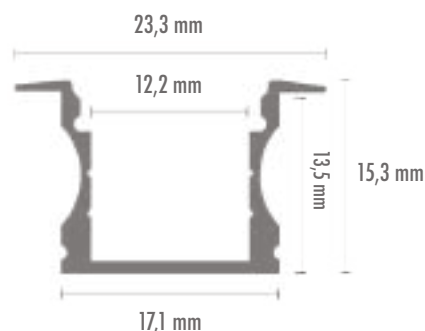

ARTIGOS COMPATÍVEIS COMPATIBLE ARTICLES / ARTICLES COMPATIBLES

Difusores Diffuser / Diffuseur	Referência Reference / Référence	Acabamento Color / Couleur	PVP
-----------------------------------	-------------------------------------	-------------------------------	-----

	DIF-A-OP	Opalino Opaline	3,21 €
	DIF-A-TR	Transparente Transparent	3,21 €
	DIF-A-B	Preto Black / Noir	4,65 €

Accesórios Accessories / Accessoires	Referência Reference / Référence	Acabamento Color / Couleur	PVP
-----------------------------------------	-------------------------------------	-------------------------------	-----

	END-IN002-G	Cinzento Grey / Gris	0,50 €
	END-IN002-B	Preto Black / Noir	0,50 €
	END-IN002-W	Branco White / Blanc	0,50 €







IN 003



Perfil de encastrar com apenas 9 mm de profundidade, que permite instalar até duas fitas de 8mm e assim obter maior luminosidade ou combinar cores.





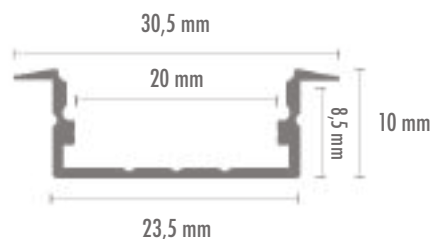

(ENG) Recessed profile just 9 mm deep, that allows to install two 8mm LED's strips and thus obtain greater luminosity or combine colors.

(FR) Profilé d'encastrement avec seulement 9 mm de profondeur, qui permet d'appliquer jusqu'à deux bandes de 8 mm et ainsi obtenir une plus grande luminosité ou combiner les couleurs.

Perfil Profile / Profilé	Referência Reference / Référence	Acabamento Color / Couleur	PVP
	IN003-A	Anodizado cinzento Grey Anodized / Gris Anodisé	12,53 €
	IN003-B	Lacado Preto Black Lacquered / Laqué Noir	16 €
	IN003-W	Lacado Branco White Lacquered / Laqué Blanc	16 €
	IN003-RAL	RAL	41,35 €



ARTIGOS COMPATÍVEIS COMPATIBLE ARTICLES / ARTICLES COMPATIBLES

Difusores Diffuser / Diffuseur	Referência Reference / Référence	Acabamento Color / Couleur	PVP	Accessórios Accessories / Accessoires	Referência Reference / Référence	Acabamento Color / Couleur	PVP
	DIF-B-OP	Opalino Opaline	4,78 €		END-IN003-G	Cinzento Grey / Gris	0,50 €
	DIF-B-TR	Transparente Transparent	4,78 €		END-IN003-B	Preto Black / Noir	0,50 €
	DIF-B-B	Preto Black / Noir	6,00 €		END-IN003-W	Branco White / Blanc	0,50 €



IN 004



Perfil robusto que permite colocar molas de fixação. Ideal para instalação em tetos e paredes. Pode instalar até duas fitas de 8 mm no interior.



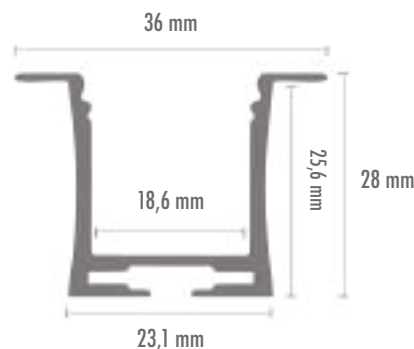

(ENG) Robust profile that allows fixing springs. Ideal for installation on ceilings and walls. You can install up to two 8 mm LED's strips inside.

(FR) Profilé robuste qui permet une fixation avec des ressorts. Idéal pour des installations sur plafonds et les murs. Vous pouvez installer jusqu'à deux bandes LED de 8 mm à l'intérieur.

Perfil Profile / Profilé	Referência Reference / Référence	Acabamento Color / Couleur	PVP
	IN004-A	Anodizado cinzento Grey Anodized / Gris Anodisé	24,34 €
	IN004-RAL	RAL	47,78 €



ARTIGOS COMPATÍVEIS COMPATIBLE ARTICLES / ARTICLES COMPATIBLES

Difusores Diffuser / Diffuseur	Referência Reference / Référence	Acabamento Color / Couleur	PVP	Accessórios Accessories / Accessoires	Referência Reference / Référence	Acabamento Color / Couleur	PVP
	DIF-D-OP	Opalino Opaline	4,78 €		END-IN004-G	Cinzento Grey / Gris	0,50 €
					SPRING	Cinzento Grey / Gris	1,40 €
					UNI-10	Cinzento Grey / Gris	2,85 €
					UNI190-10	Cinzento Grey / Gris	3,60 €



IN 005



Perfil sugerido para linhas de luz intensa. Indicado para espaços de lazer e de trabalho.





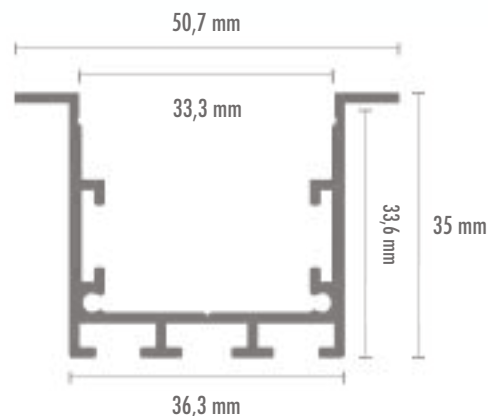

(ENG) Ideal profile for lines of intense light. Ideal for leisure and work spaces.

(FR) Profilé souvent suggérer pour avoir des lignes de lumière intense. Idéal pour les espaces de loisirs et de travail.

Perfil Profile / Profilé	Referência Reference / Référence	Acabamento Color / Couleur	PVP
	IN005-A	Anodizado cinzento Grey Anodized / Gris Anodisé	34,69 €
	IN005-W	Lacado Branco White Lacquered / Laqué Blanc	43,97 €
	IN005-RAL	RAL	61,43 €



ARTIGOS COMPATÍVEIS COMPATIBLE ARTICLES / ARTICLES COMPATIBLES

Difusores Diffuser / Diffuseur	Referência Reference / Référence	Acabamento Color / Couleur	PVP	Accessórios Accessories / Accessoires	Referência Reference / Référence	Acabamento Color / Couleur	PVP
	DIF-F-OP DIF-F-OP-6M	Opalino Opaline	2m - 10,24 € 6m - 30,72 €		END-IN005-G	Cinzento Grey / Gris	1,00 €
					END-IN005-W	Branco White / Blanc	1,00 €
					SPRING	Cinzento Grey / Gris	1,40 €
					UNI-10	Cinzento Grey / Gris	2,85 €
					UNI90-10	Cinzento Grey / Gris	3,60 €



IN 006







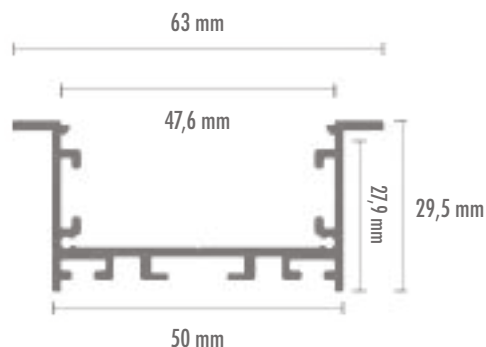

Perfil largo para instalações mais exigentes. Solução indicada para locais com maior necessidade de luz.
 (ENG) Wide profile for more challenging installations. Solution indicated for places with greater need for light.
 (FR) Profilé large pour des installations plus exigeantes. Solution adéquat pour les endroits avec un plus grand besoin de lumière.

Perfil Profile / Profilé	Referência Reference / Référence	Acabamento Color / Couleur	PVP
	IN006-A	Anodizado cinzento Grey Anodized / Gris Anodisé	39,74 €
	IN006-W	Lacado Branco White Lacquered / Laqué Blanc	50,04 €
	IN006-RAL	RAL	69,81 €



ARTIGOS COMPATÍVEIS COMPATIBLE ARTICLES / ARTICLES COMPATIBLES

Difusores Diffuser / Diffuseur	Referência Reference / Référence	Acabamento Color / Couleur	PVP
	DIF-G-OP	Opalino	2m - 12,48 €
	DIF-G-OP-6M	Opaline	6m - 37,44 €

Accessórios Accessories / Accessoires	Referência Reference / Référence	Acabamento Color / Couleur	PVP
	END-IN005-G	Cinzento Grey / Gris	1,00 €
	END-IN005-W	Branco White / Blanc	1,00 €
	SPRING	Cinzento Grey / Gris	1,40 €
	UNI-7	Cinzento Grey / Gris	2,85 €
	UNI-15	Cinzento Grey / Gris	2,85 €
	UNI90-7	Cinzento Grey / Gris	3,60 €
	UNI90-15	Cinzento Grey / Gris	3,60 €



PRO 001



Perfil para pladour. Solução oculta para que não haja alumínio visível. A dimensão não compromete a estrutura do tecto ou da parede.
 (ENG) Plasterboard profile. Hidden solution so that there are no visible aluminum. The size does not compromise the structure of the ceiling or wall.
 (FR) Profilé pour des surfaces en plâtre. Solution pour que l'aluminium ne soit pas visible. La taille ne compromet pas la structure du plafond ou du mur.

Perfil Profile / Profilé	Referência Reference / Référence	Acabamento Color / Couleur	PVP
	PRO001-A	Anodizado cinzento Grey Anodized / Gris Anodisé	19,79 €

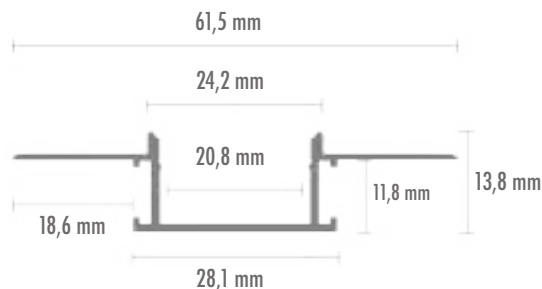

ARTIGOS COMPATÍVEIS COMPATIBLE ARTICLES / ARTICLES COMPATIBLES

Difusores Diffuser / Diffuseur	Referência Reference / Référence	Acabamento Color / Couleur	PVP	Accessórios Accessories / Accessoires	Referência Reference / Référence	Acabamento Color / Couleur	PVP
	DIF-K-OP	Opalino Opaline	5,20 €		END-PRO001-G	Cinzento Grey / Gris	0,50 €
	DIF-K-B	Preto Black / Noir	6,40 €		END-PRO001-B	Preto Black / Noir	0,50 €



PRO 002



Perfil largo para pladour. Solução oculta para instalações onde seja necessária mais luminosidade.

(ENG) Wide profile for plasterboard. Hidden solution for installations where more light is needed.

(FR) Profilé pour des surfaces en plâtre. Solution pour que l'aluminium ne soit pas visible et idéal dans les espaces où il y a un grand besoin de lumière.

Perfil Profile / Profilé	Referência Reference / Référence	Acabamento Color / Couleur	PVP
	PRO002-A	Anodizado cinzento Grey Anodized / Gris Anodisé	37,23 €

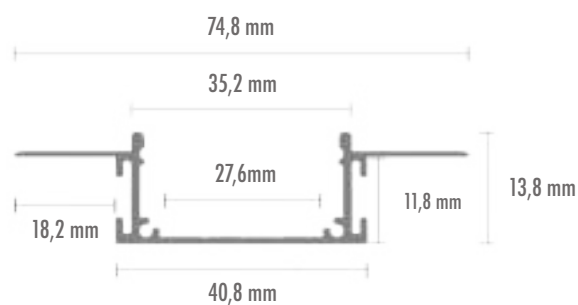

ARTIGOS COMPATÍVEIS COMPATIBLE ARTICLES / ARTICLES COMPATIBLES

Difusores Diffuser / Diffuseur	Referência Reference / Référence	Acabamento Color / Couleur	PVP
	DIF-L-OP	Opalino Opaline	5,87 €

Acessórios Accessories / Accessoires	Referência Reference / Référence	Acabamento Color / Couleur	PVP
	END-PRO002-G	Cinzento Grey / Gris	1,00 €



PRO 003





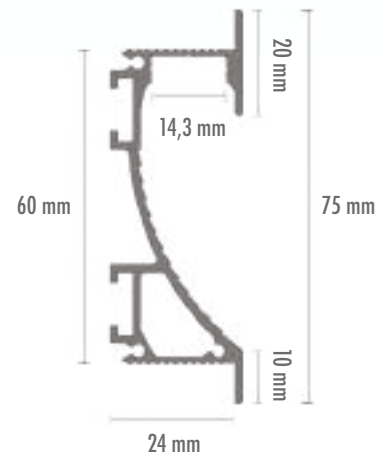

Perfil de encastrar para criação de sancas ou rodapés com iluminação indireta.
 (ENG) Recessed profile with coving LED's or baseboards for indirect lighting.
 (FR) Profilé d'encastrement avec corniche ou plinthes pour une éclairage indirect.

Perfil Profile / Profilé	Referência Reference / Référence	Acabamento Color / Couleur	PVP
	PRO003-A	Anodizado cinzento Grey Anodized / Gris Anodisé	121,39 €
	PRO003-W	Lacado Branco White Lacquered / Laqué Blanc	138,13 €
	PRO003-RAL	RAL	148,97 €



ARTIGOS COMPATÍVEIS COMPATIBLE ARTICLES / ARTICLES COMPATIBLES

Difusores Diffuser / Diffuseur	Referência Reference / Référence	Acabamento Color / Couleur	PVP	Accessórios Accessories / Accessoires	Referência Reference / Référence	Acabamento Color / Couleur	PVP
	DIF-M-OP	Opalino Opaline	29,25 €		END-PRO003-G	Cinzento Grey / Gris	4,95 €
					END-PRO003-W	Branco White / Blanc	4,95 €
					SPRING-2	Cinzento Grey / Gris	1,40 €



PRO 004



Perfil simples para criação de sancas ou rodapés com iluminação direta.

(ENG) Simple profile with coving LED's or baseboards for direct lighting.

(FR) Profilé simple d'encastrement avec corniche ou plinthes pour une éclairage direct.

Perfil Profile / Profilé	Referência Reference / Référence	Acabamento Color / Couleur	PVP
	PRO004-A	Anodizado cinzento Grey Anodized / Gris Anodisé	27,09 €
	PRO004-RAL	RAL	54,60 €

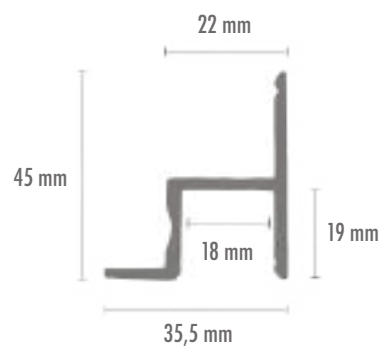

ARTIGOS COMPATÍVEIS COMPATIBLE ARTICLES / ARTICLES COMPATIBLES

Difusores Diffuser / Diffuseur	Referência Reference / Référence	Acabamento Color / Couleur	PVP	Acessórios Accessories / Accessoires	Referência Reference / Référence	Acabamento Color / Couleur	PVP
	DIF-N-OP	Opalino Opaline	4,29 €		END-PRO004-G	Cinzento Grey / Gris	0,50 €



PRO 005



2m

15W
Max.W/m



Perfil para degrau. Solução ideal para realçar as linhas de escadaria.

(ENG) Profile for stair step. Ideal solution to value the stairway lines.

(FR) Profilé pour les marches. Solution idéale pour mettre en valeur les lignes d'escalier.

Perfil Profile / Profilé	Referência Reference / Référence	Acabamento Color / Couleur	PVP
-----------------------------	-------------------------------------	-------------------------------	-----



PRO005-A

Anodizado cinzento
Grey Anodized / Gris Anodisé

78 €

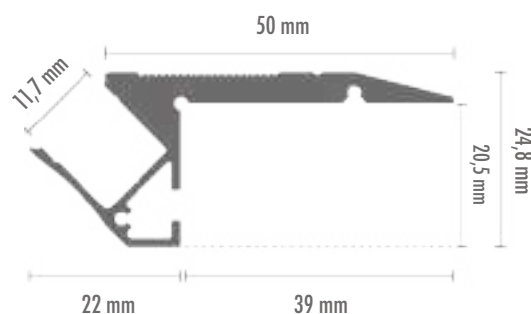

ARTIGOS COMPATÍVEIS COMPATIBLE ARTICLES / ARTICLES COMPATIBLES

Difusores Diffuser / Diffuseur	Referência Reference / Référence	Acabamento Color / Couleur	PVP
-----------------------------------	-------------------------------------	-------------------------------	-----



DIF-0-OP

Opalino
Opaline

35,75 €

Acessórios Accessories / Accessoires	Referência Reference / Référence	Acabamento Color / Couleur	PVP
-----------------------------------------	-------------------------------------	-------------------------------	-----



END-PRO005-G

Cinzento
Grey / Gris

4,95 €



PRO 006



Perfil para degrau. Ideal para iluminar e destacar os degraus do espaço.

(ENG) Profile for stair step. Ideal to illuminate and highlight the steps of space.

(FR) Profilé pour les marches. Idéal pour éclairer et mettre en valeur les marches de l'espace habitation ou commerce.

Perfil Profile / Profilé	Referência Reference / Référence	Acabamento Color / Couleur	PVP
-----------------------------	-------------------------------------	-------------------------------	-----



PRO006-A

Anodizado cinzento
Grey Anodized / Gris Anodisé

78 €

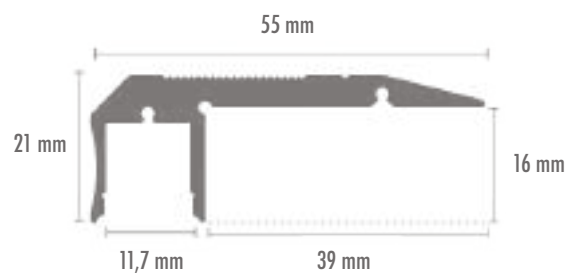

ARTIGOS COMPATÍVEIS COMPATIBLE ARTICLES / ARTICLES COMPATIBLES

Difusores Diffuser / Diffuseur	Referência Reference / Référence	Acabamento Color / Couleur	PVP
-----------------------------------	-------------------------------------	-------------------------------	-----



DIF-P-OP

Opalino
Opaline

35,75 €

Acessórios Accessories / Accessoires	Referência Reference / Référence	Acabamento Color / Couleur	PVP
-----------------------------------------	-------------------------------------	-------------------------------	-----



END-PRO006-G

Cinzento
Grey / Gris

4,95 €



PRO 007



Perfil para pavimento. Instalação simples e de elevada resistência física e à humidade.
 (ENG) Floor profile. Simple installation with high physical and humidity resistance.
 (FR) Profilé pour le plancher, d'installation simple avec de la haute résistance physique et à l'humidité.

Perfil Profile / Profilé	Referência Reference / Référence	Acabamento Color / Couleur	PVP
	PRO007-A	Anodizado cinzento Grey Anodized / Gris Anodisé	39 €

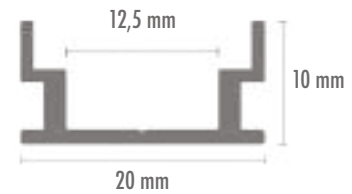

ARTIGOS COMPATÍVEIS COMPATIBLE ARTICLES / ARTICLES COMPATIBLES

Difusores Diffuser / Diffuseur	Referência Reference / Référence	Acabamento Color / Couleur	PVP	Acessórios Accessories / Accessoires	Referência Reference / Référence	Acabamento Color / Couleur	PVP
	DIF-Q-OP	Opalino Opaline	32,50 €		END-PRO007-G	Cinzento Grey / Gris	2,95 €



PRO 008



Perfil para pavimento. Instalação simples e de elevada resistência física e à humidade. Solução com abas para acabamento.

(ENG) Floor profile. Simple installation with high physical and humidity resistance. Finished flap solution.

(FR) Profilé pour le plancher, d'installation simple avec de la haute résistance physique et à l'humidité. Une solution avec rabat pour la finition.

Perfil Profile / Profilé	Referência Reference / Référence	Acabamento Color / Couleur	PVP
-----------------------------	-------------------------------------	-------------------------------	-----



PRO008-A

Anodizado cinzento
Grey Anodized / Gris Anodisé

39 €

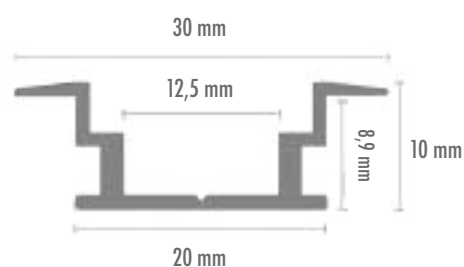

ARTIGOS COMPATÍVEIS COMPATIBLE ARTICLES / ARTICLES COMPATIBLES

Difusores Diffuser / Diffuseur	Referência Reference / Référence	Acabamento Color / Couleur	PVP
-----------------------------------	-------------------------------------	-------------------------------	-----



DIF-Q-OP

Opalino
Opaline

32,50 €

Acessórios Accessories / Accessoires	Referência Reference / Référence	Acabamento Color / Couleur	PVP
-----------------------------------------	-------------------------------------	-------------------------------	-----



END-PRO008-G

Cinzento
Grey / Gris

2,95 €



PRO 009



Perfil fundo para pavimento. Instalação simples e de elevada resistência física e à humidade.
 (ENG) Deep floor profile. Simple installation with high physical and humidity resistance.
 (FR) Profilé profond pour le plancher, d'installation simple avec de la haute résistance physique et à l'humidité.

Perfil Profile / Profilé	Referência Reference / Référence	Acabamento Color / Couleur	PVP
-----------------------------	-------------------------------------	-------------------------------	-----



PRO009-A

Anodizado cinzento
Grey Anodized / Gris Anodisé

69,88 €

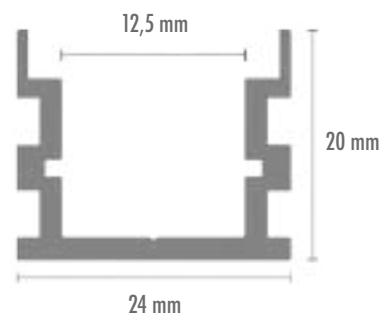

ARTIGOS COMPATÍVEIS COMPATIBLE ARTICLES / ARTICLES COMPATIBLES

Difusores Diffuser / Diffuseur	Referência Reference / Référence	Acabamento Color / Couleur	PVP
-----------------------------------	-------------------------------------	-------------------------------	-----



DIF-R-OP

Opalino
Opaline

35,75 €

Acessórios Accessories / Accessoires	Referência Reference / Référence	Acabamento Color / Couleur	PVP
-----------------------------------------	-------------------------------------	-------------------------------	-----



END-PRO009-G

Cinzento
Grey / Gris

4,95 €



PRO 010



Perfil robusto para pavimento. Instalação simples e de elevada resistência física e à humidade. Solução com abas para acabamento.

(ENG) Robust floor profile. Simple installation with high physical and humidity resistance. Finished flap solution.

(FR) Profilé pour le plancher, d'installation simple avec de la haute résistance physique et à l'humidité. Une solution avec rabat pour la finition.

Perfil Profile / Profilé	Referência Reference / Référence	Acabamento Color / Couleur	PVP
-----------------------------	-------------------------------------	-------------------------------	-----



PRO010-A

Anodizado cinzento
Grey Anodized / Gris Anodisé

69,88 €

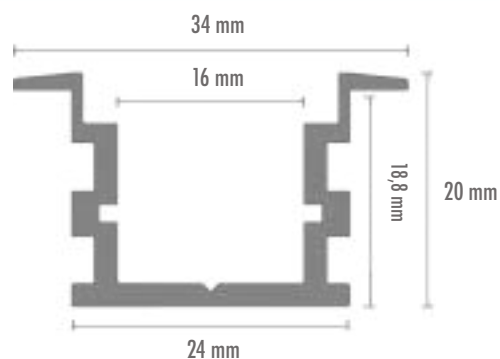

ARTIGOS COMPATÍVEIS COMPATIBLE ARTICLES / ARTICLES COMPATIBLES

Difusores Diffuser / Diffuseur	Referência Reference / Référence	Acabamento Color / Couleur	PVP
-----------------------------------	-------------------------------------	-------------------------------	-----



DIF-R-OP

Opalino
Opaline

35,75 €

Acessórios Accessories / Accessoires	Referência Reference / Référence	Acabamento Color / Couleur	PVP
-----------------------------------------	-------------------------------------	-------------------------------	-----



END-PRO010-G

Cinzento
Grey / Gris

2,95 €



PRO 011



Perfil robusto para pavimento. Instalação simples e de elevada resistência física e à humidade. Solução que aguenta passagem de peso até 1 tonelada.

(ENG) floor profile. Simple installation with high physical and humidity resistance. This solution that can handle a weight of up to 1 ton..

(FR) Profilé pour le plancher, simple à installer avec de la haute résistance physique et à l'humidité. Une solution que peut supporter le passage d'un poids allant jusqu'à 1 tonne.

Perfil Profile / Profilé	Referência Reference / Référence	Acabamento Color / Couleur	PVP
	PRO011-A	Anodizado cinzento Grey Anodized / Gris Anodisé	104 €

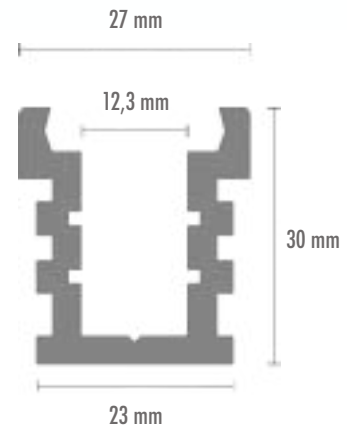

ARTIGOS COMPATÍVEIS COMPATIBLE ARTICLES / ARTICLES COMPATIBLES

Difusores Diffuser / Diffuseur	Referência Reference / Référence	Acabamento Color / Couleur	PVP
	DIF-S-OP	Opalino Opaline	39,38 €

Acessórios Accessories / Accessoires	Referência Reference / Référence	Acabamento Color / Couleur	PVP
	END-PRO011-G	Cinzento Grey / Gris	4,95 €



PRO 012



Perfil para pladour. Solução oculta para que não haja alumínio visível, ideal para linhas de luz mais subtis com uma só fita.

(ENG) Pladour profile. Hidden solution so that there is no visible aluminum, ideal for more subtle beamlines with a single LED strip.

(FR) Profilé pour des surfaces en plâtre. Solution pour qu'il n'y ait pas d'aluminium visibles, idéale pour avoir des lignes de lumière plus subtiles avec une seule bande LED.

Perfil Profile / Profilé	Referência Reference / Référence	Acabamento Color / Couleur	PVP
	PRO012-A	Anodizado cinzento Grey Anodized / Gris Anodisé	18,77 €

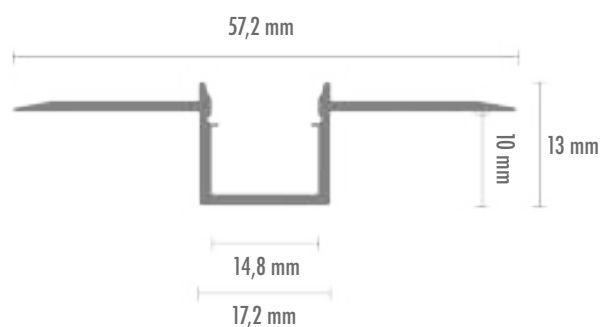

ARTIGOS COMPATÍVEIS COMPATIBLE ARTICLES / ARTICLES COMPATIBLES

Difusores Diffuser / Diffuseur	Referência Reference / Référence	Acabamento Color / Couleur	PVP	Acessórios Accessories / Accessoires	Referência Reference / Référence	Acabamento Color / Couleur	PVP
	DIF-A-OP	Opalino Opaline	3,21 €		END-PRO012-G	Cinzento Grey / Gris	0,50 €
	DIF-A-TR	Transparente Transparent	3,21 €				
	DIF-A-B	Preto Black / Noir	4,65 €				
	DIF-A2-OP	Opalino Opaline	3,21 €				



PRO 013

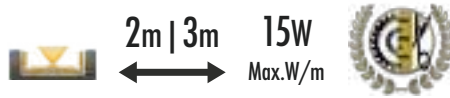

Perfil de canto interior para pladour. Acabamento perfeito e luminosidade incrível.
 (ENG) Interior corner profile for plasterboard. Perfect finish and incredible luminosity.
 (FR) Profilé d'angle intérieur pour le plâtre. Finition parfaite et luminosité incroyable.

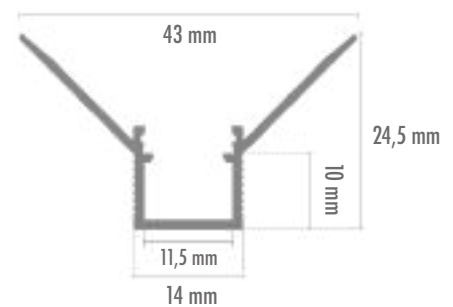

Perfil Profile / Profilé	Referência Reference / Référence	Acabamento Color / Couleur	PVP
	PRO013-A PRO013-A-3M	Anodizado cinzento Grey Anodized / Gris Anodisé	2m - 19,18 € 3m - 28,77 €

ARTIGOS COMPATÍVEIS
 COMPATIBLE ARTICLES / ARTICLES COMPATIBLES

Difusores Diffuser / Diffuseur	Referência Reference / Référence	Acabamento Color / Couleur	PVP	Accessórios Accessories / Accessoires	Referência Reference / Référence	Acabamento Color / Couleur	PVP
	DIF-U-OP DIF-U-OP-3M	Opalino Opaline	2m - 3,21 € 3m - 4,82 €		END-PRO013-G	Cinzento Grey / Gris	0,50 €



PRO 014





Perfil de canto exterior para pladour. Acabamento perfeito e luminosidade incrível.
 (ENG) Exterior corner profile for plasterboard. Perfect finish and incredible luminosity.
 (FR) Profilé d'angle extérieur pour le plâtre. Finition parfaite et luminosité incroyable.

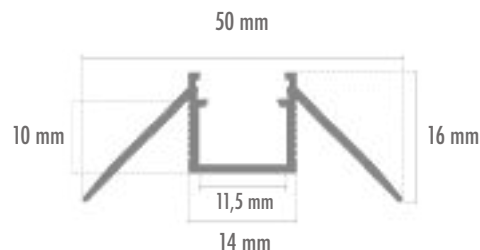

Perfil Profile / Profilé	Referência Reference / Référence	Acabamento Color / Couleur	PVP
	PRO014-A PRO014-A-3M	Anodizado cinzento Grey Anodized / Gris Anodisé	2m - 19,18 € 3m - 28,77 €



ARTIGOS COMPATÍVEIS COMPATIBLE ARTICLES / ARTICLES COMPATIBLES

Difusores Diffuser / Diffuseur	Referência Reference / Référence	Acabamento Color / Couleur	PVP	Accessórios Accessories / Accessoires	Referência Reference / Référence	Acabamento Color / Couleur	PVP
	DIF-U-OP DIF-U-OP-3M	Opalino Opaline	2m - 3,21 € 3m - 4,82 €		END-PRO014-G	Cinzento Grey / Gris	0,50 €



PRO 015



Perfil desenhado para iluminação indireta em pladour (ex. Rodapé). Proporciona uma fácil instalação, discreta e um resultado magnífico.

(ENG) Profile designed for indirect lighting in pladour (eg. plinth). Provides an easy, discreet installation and a magnificent result.

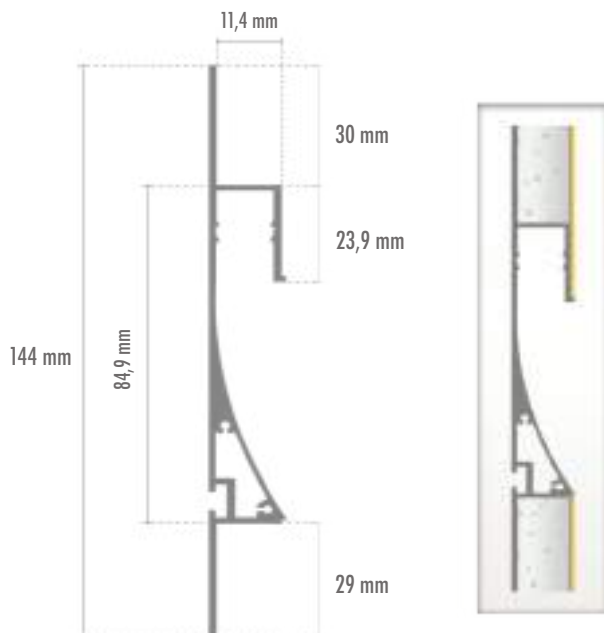

(FR) Profil conçu pour l'éclairage indirect en pladour (ex. plinthe). Fournit une installation facile et discrète et un résultat magnifique.

Perfil Profile / Profilé	Referência Reference / Référence	Acabamento Color / Couleur	PVP
	PRO015-W	Lacado Branco White Lacquered / Laqué Blanc	75,18 €
	PRO015-RAL	RAL	97,50 €



ARTIGOS COMPATÍVEIS COMPATIBLE ARTICLES / ARTICLES COMPATIBLES

Difusores Diffuser / Diffuseur	Referência Reference / Référence	Acabamento Color / Couleur	PVP
	DIF-V-OP	Opalino Opaline	4,20 €

Acessórios Accessories / Accessoires	Referência Reference / Référence	Acabamento Color / Couleur	PVP
	UNI-PRO015	Cinzento Grey / Gris	7,34 €
	UNI90-PRO015	Cinzento Grey / Gris	7,70 €

A blue background with a white, curled-up corner in the top right, revealing a strip of LED lights. The strip contains various components like resistors, capacitors, and small yellow LEDs.

e⁺ LED

EPLUS LED, é uma gama especializada em iluminação linear. As nossas fitas foram concebidas para uso intensivo, sem interrupções, eficiência superior a 100LM/W com níveis de luminosidade altos e cores muito definidas.

O grau de exigência a que nos propomos só é conseguido através da seleção cuidada dos componentes e dos melhores fabricantes Europeus/Asiáticos, garantindo os padrões de qualidade mais altos da indústria.

Obtenha sempre a mesma cor (3-Step MacAdam) e mantenha a melhor reprodução cromática (CRI >80/90).

(ENG) EPLUS LED is a range specialized in linear lighting.

Our tapes are designed for intensive use, without interruptions, an efficiency above 100LM/W, with high brightness levels and very defined colors.

The level of demand we set ourselves is only achieved through the careful selection of components and the best European/Asian manufacturers, guaranteeing the highest quality standards in the industry.

Always get the same color (3-Step MacAdam) at all times and maintain the best chromatic reproduction (CRI >80/90).

(FR) EPLUS LED est une gamme spécialisée dans l'éclairage linéaire.

Nos rubans sont conçus pour une utilisation intensive, sans interruption, avec une efficacité supérieure à 100LM/W, des niveaux de luminosité très élevés et des couleurs très définies.

Le niveau d'exigence que nous nous fixons n'est atteint que grâce à une sélection rigoureuse des composants et des meilleurs fabricants Européens/Asiatiques, garantissant les normes de qualité les plus élevées de l'industrie.

Obtenez toujours la même couleur (3-Step MacAdam) et maintenez la meilleure reproduction chromatique (IRC >80/90).

 **EFFI 30W**

LED

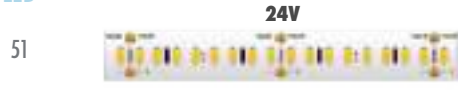

40Z 
EFFICIENCY
+175 lm/W

 **ECOB 15W**

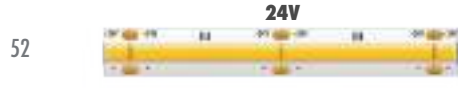

IP65

 **ECOB 10W**

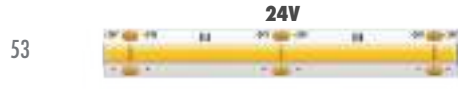

IP65

EPRO 22W



EPRO 16.8W



IP65

EPRO 14.4W



 **EPRO 9.6W**



EPRO 4.8W



EPRO 24W
CCT





EPRO 19.2W
RGB+W



40Z 

EPRO 24W
RGB+CCT



40Z 

EPRO 14.4W
RGB DIGITAL





EPRO 14.4W
RGB





HQS 14.4W
RGB

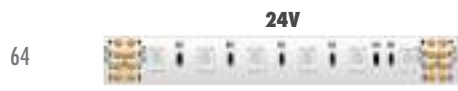



 **EPRO S 7.2W**



 **IP65** 

 **EPRO S LENS 16W**



 **IP44**

SIMBOLOGIA

(ENG) SYMBOLOGY (FR) SYMBOLOGIE

LED



Funcionamento Ininterrupto
(ENG) Uninterrupted Operation
(FR) Fonctionnement Ininterrompu



Vida Útil
(ENG) Lifespan
(FR) Durée de vie



Profundidade de iluminação Direta
(ENG) Direct Lighting Depth
(FR) Profondeur d'Éclairage Périmétrique



Ângulo de abertura
(ENG) Opening angle
(FR) Angle d'ouverture



Dimável
(ENG) Dimable
(FR) Dimmable



LEDs/m

Nº de Leds por metro
(ENG) Number of LEDs per meter
(FR) Nombre de LEDs par mètre



Índice de Reprodução Cromática
(ENG) Color Rendering Index
(FR) Indice de Rendu de Couleur



Nº de Metros por rolo
(ENG) Number of Meters per roll
(FR) Nombre de Mètres par rouleau



Elevada Eficiência
(ENG) High Efficiency
(FR) Haute efficacité



Tipo de Led
(ENG) Led type
(FR) Type de Led



Aplicável em todo o tipo de ângulos
(ENG) Applicable on all types of angles
(FR) Applicable sur tous les types d'angles



CCT



RGB+W



RGB+CCT



RGB



RGB DIGITAL



Espessura da Pista de Cobre
(ENG) Copper Runway Thickness
(FR) Épaisseur de la Piste en Cuivre



Proteção contra objetos sólidos com 2,5 mm de diâmetro ou mais e à prova de borrifos de água
(ENG) Protection against solid objects 2.5 mm in diameter or larger and splash proof
(FR) Protection contre les objets solides de 2,5 mm de diamètre ou plus et résistant aux éclaboussures



Proteção contra objetos sólidos maiores que 1 mm e respingos de água
(ENG) Protection against solid objects larger than 1 mm and water splash
(FR) Protection contre les corps solides supérieurs à 1 mm et éclaboussure d'eau



À prova de poeiras e proteção contra jatos de água
(ENG) Dust proof and water jet protection
(FR) Anti-poussière et protection contre les jets d'eau



À prova de poeiras e proteção contra imersão temporária em água
(ENG) Dust proof and protection against temporary immersion in water
(FR) Anti-poussière et protection contre l'immersion temporaire dans l'eau



Anos de Garantia
(ENG) Years Warranty
(FR) Années de Garantie



Chip SAMSUNG 2835
(ENG) SAMSUNG 2835 Chip
(FR) Puce SAMSUNG 2835



3 Step MacAdam



Corte GRATUITO
(ENG) FREE cutting
(FR) Coupe GRATUITE



Certificado ETL
(ENG) ETL Certificate
(FR) Certificat ETL



Certificado RoHS compliant
(ENG) RoHS compliant Certificate
(FR) Certificat RoHS compliant



Conformidade com as diretivas legais vigentes na Europa
(ENG) Compliance with legal directives in Europe
(FR) Conformité aux directives légales en vigueur en Europe



Impróprio ao lixo comum
(ENG) Inappropriate for common garbage
(FR) Inapproprié pour les ordures ménagères



EFFI 30W



A nova fita de EFFI traz alta luminosidade com menor consumo. A melhor solução para iluminar grandes áreas. Com 5000 lumens por metro e apenas 30W, é possível iluminar divisões inteiras sem consumos pesados.

(ENG) The new EFFI Led strip brings high luminosity with less consumption. The best solution for illuminating large areas. With 5000 lumens per meter and only 30W, it is possible to light up entire rooms without heavy consumption.

(FR) Le nouveau ruban EFFI apporte une luminosité élevée avec moins de consommation. La meilleure solution pour éclairer de grandes surfaces. Avec 5000 lumens par mètre et seulement 30W, il est possible d'éclairer des pièces entières sans grosse consommation.

Referência Reference Référence	Temperatura de cor Color temperature Température de couleur	Intensidade luminosa (lm) Light Intensity Intensité lumineuse	PVP P/m
EFFI-30W24V3000KIP20	● 3000k	4947 lm	19,50 €
EFFI-30W24V4000KIP20	○ 4000k	5189 lm	
EFFI-30W24V6500KIP20	● 6500k	5189 lm	

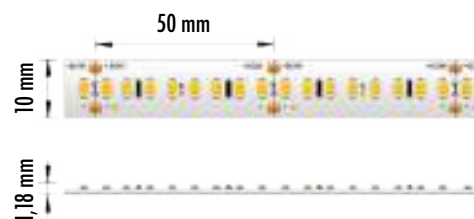

24V
IP20





LED

ECOB 15W



Concebida para eliminar os pontos visíveis do Led e manter uma alta intensidade luminosa. Com CRI>90 é uma excelente solução para espaços comerciais e mobiliário.

(ENG) Designed to eliminate visible LED spots and maintain a high luminous intensity. With CRI>90 it is an excellent solution for commercial spaces and furniture.

(FR) Conçu pour éliminer les spots LED visibles et maintenir un haut niveau intensité lumineuse. Avec CRI>90, c'est une excellente solution pour les espaces commerciaux et les meubles.

24V
IP20

24V
IP65

Referência Reference Référence	Temperatura de cor Color temperature Température de couleur	Intensidade luminosa (lm) Light Intensity Intensité lumineuse	PVP P/m
ECOB-15W24V3000KIP20	● 3000k	1557 lm	12,23 €
ECOB-15W24V4000KIP20	○ 4000k	1575 lm	
ECOB-15W24V6500KIP20	● 6500k	1650 lm	
ECOB-15W24V3000KIP65	● 3000k	1401 lm	14,63 €
ECOB-15W24V4000KIP65	○ 4000k	1418 lm	
ECOB-15W24V6500KIP65	● 6500k	1485 lm	

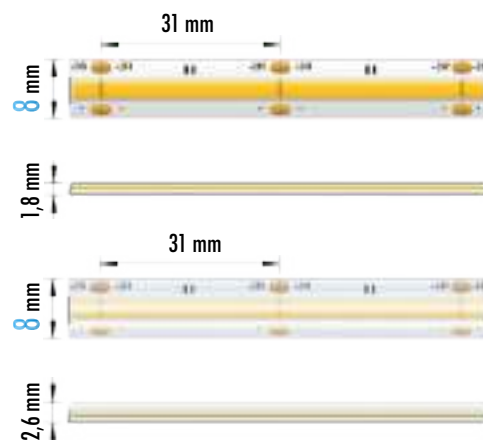



ECOB 10W



Concebida para eliminar os pontos do Led, com 8mm, com CRI>90 e baixo consumo, é a melhor solução para linhas que fiquem visíveis (ex. estantes).

(ENG) Designed to eliminate Led dots, with 8mm, with CRI>90 and low consumption, it is the best solution for lines that are visible (eg shelves).

(FR) Conçu pour enlever les points visibles de la bande LED, de 8 mm, avec un IRC>90 et une faible consommation, c'est la meilleure solution pour les lignes visibles (ex. sur les étagères).

Referência Reference Référence	Temperatura de cor Color temperature Température de couleur	Intensidade luminosa (lm) Light Intensity Intensité lumineuse	PVP P/m
ECOB-10W24V3000KIP20	● 3000k	910 lm	9,10 €
ECOB-10W24V4000KIP20	○ 4000k	950 lm	
ECOB-10W24V6500KIP20	● 6500k	1000 lm	
ECOB-15W24V3000KIP65	● 3000k	819 lm	11,40 €
ECOB-15W24V4000KIP65	○ 4000k	855 lm	
ECOB-15W24V6500KIP65	● 6500k	900 lm	

24V
IP20

24V
IP65

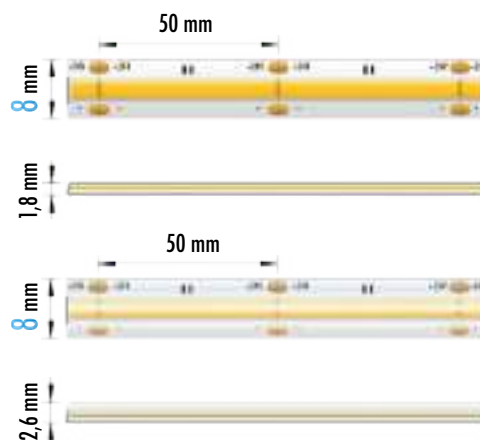

LED



EPRO 22W



Concebida para uso intensivo, a fita de 22W com 120 Leds por metro é indicada para ambientes de trabalho ou estudo, exposição de produtos e iluminação interior ou exterior, garantindo níveis altos de luminosidade.

(ENG) Designed for intensive use, the 22W with 120 LEDs per meter LED strip is suitable for work or study environments, product display and indoor or outdoor lighting, ensuring high levels of light.

(FR) Conçues pour un usage intensif, la bande LED de 22W avec 120 LEDs par mètre convient aux environnements de travail ou d'étude, à l'affichage des produits et à l'éclairage d'intérieur ou d'extérieur, garantissant des niveaux de luminosité très élevés.

Referência Reference Référence	Temperatura de cor Color temperature Température de couleur	Intensidade luminosa (lm) Light Intensity Intensité lumineuse	PVP P/m
12V IP20 EPRO-22W12V2700KIP20	● 2700k	2091 lm	13,29 €
EPRO-22W12V3000KIP20	● 3000k	2180 lm	
EPRO-22W12V4000KIP20	○ 4000k	2314 lm	
EPRO-22W12V6500KIP20	● 6500k	2269 lm	
24V IP20 EPRO-22W24V2700KIP20	● 2700k	2091 lm	13,29 €
EPRO-22W24V3000KIP20	● 3000k	2180 lm	
EPRO-22W24V4000KIP20	○ 4000k	2314 lm	
EPRO-22W24V6500KIP20	● 6500k	2269 lm	

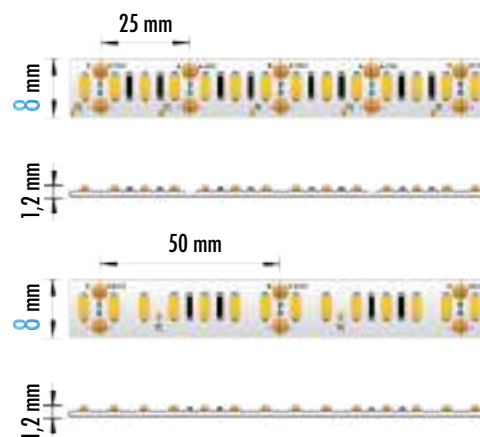



EPRO 16.8W

Uma fita pensada para aplicação em ambientes húmidos e secos. Com 16.8W, 84 leds e IP65, pode iluminar qualquer zona da sua habitação em segurança, mantendo uma boa intensidade luminosa.

(ENG) A tape designed for application in wet and dry environments. With 16.8W, 84 leds and IP65, you can safely illuminate any area of your home, maintaining a good light intensity.

(FR) Un ruban conçu pour une application dans des environnements humides et secs. Avec 16,8 W, 84 leds et IP65, peut éclairer n'importe quelle zone de votre maison en toute sécurité, en gardant une bonne intensité lumineuse.

**24V
IP65**

Referência Reference Référence	Temperatura de cor Color temperature Température de couleur	Intensidade luminosa (lm) Light Intensity Intensité lumineuse	PVP P/m
EPRO-168W24V3000KIP65	● 3000k	1478 lm	9,53 €
EPRO-168W24V4000KIP65	○ 4000k	1495 lm	
EPRO-168W24V6000KIP65	● 6000k	1512 lm	





EPRO 14.4W



A solução ideal para todos os ambientes, espaços e aplicações. Com 14.4W e 60 LEDs por metro, esta é uma fita com alto fluxo luminoso. Indicada para mobiliário, locais de trabalho ou estudo, iluminação indireta ou direta, interior ou exterior.

(ENG) The ideal solution for all environments, spaces and applications. With 14.4W and 60 LEDs per meter, this is a ribbon with a high luminous flux. Suitable for furniture, work or study places, indirect or direct lighting, indoor or outdoor.

(FR) La solution idéale pour tous les environnements, espaces et applications. Avec 14,4W et 60 LEDs par mètre, c'est une bande avec un flux lumineux élevé. Convient pour les meubles, les lieux de travail ou d'étude, l'éclairage direct ou indirect, intérieur ou extérieur.

12V
IP20

Referência Reference Référence	Temperatura de cor Color temperature Température de couleur	Intensidade luminosa (lm) Light Intensity Intensité lumineuse	PVP P/m
EPRO-144W12V3000KIP20	● 3000k	1302 lm	8,66 €
EPRO-144W12V4000KIP20	○ 4000k	1389 lm	
EPRO-144W12V6500KIP20	● 6500k	1389 lm	
EPRO-144W12V3000KIP67	● 3000k	1299 lm	13,82 €
EPRO-144W12V4000KIP67	○ 4000k	1385 lm	
EPRO-144W12V6500KIP67	● 6500k	1385 lm	

12V
IP67

24V
IP20

EPRO-144W24V3000KIP20	● 3000k	1302 lm	8,66 €
EPRO-144W24V4000KIP20	○ 4000k	1389 lm	
EPRO-144W24V6500KIP20	● 6500k	1389 lm	
EPRO-144W24V3000KIP67	● 3000k	1299 lm	13,82 €
EPRO-144W24V4000KIP67	○ 4000k	1385 lm	
EPRO-144W24V6500KIP67	● 6500k	1385 lm	

24V
IP67

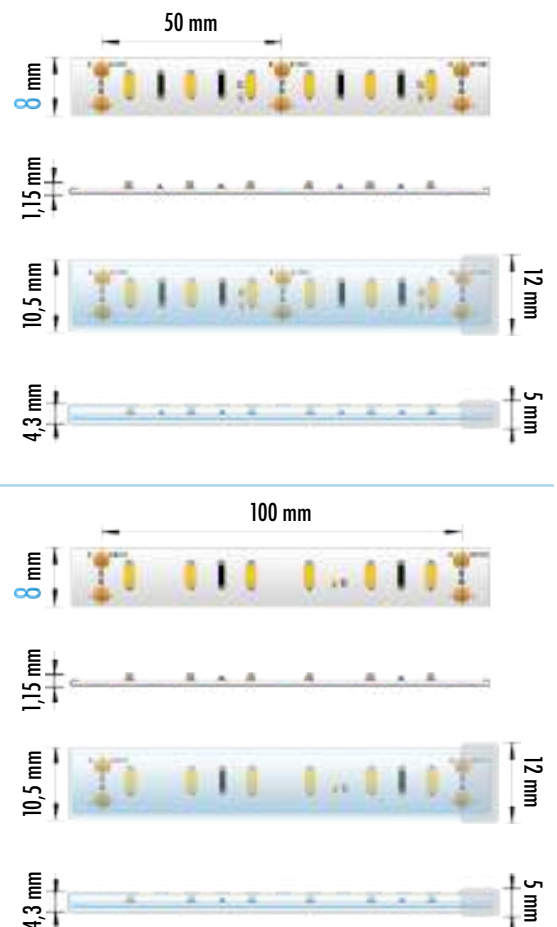



EPRO 9.6W



Fita de 60 LEDs por metro ,com mais de 100 lm / W, para ambientes relaxantes numa versão mais económica.

(ENG) Led strip of 60 LEDs per meter, with more than 100 lm / W, for relaxing environments in a more economical version.

(FR) Bande LED de 60 LED par mètre, avec plus de 100 lm / W, pour des environnements relaxants dans une version plus économique.

12V
IP20

Referência Reference Référence	Temperatura de cor Color temperature Température de couleur	Intensidade luminosa (lm) Light Intensity Intensité lumineuse	PVP P/m
EPRO-96W12V3000KIP20	● 3000k	1000 lm	7,72 €
EPRO-96W12V4000KIP20	○ 4000k	1061 lm	
EPRO-96W12V6500KIP20	● 6500k	1041 lm	
EPRO-96W12V3000KIP67	● 3000k	974 lm	12,74 €
EPRO-96W12V4000KIP67	○ 4000k	1025 lm	
EPRO-96W12V6500KIP67	● 6500k	1011 lm	

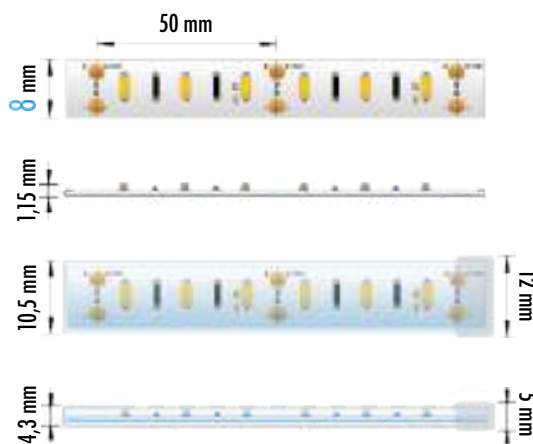

24V
IP20

EPRO-96W24V3000KIP20	● 3000k	1000 lm	7,72 €
EPRO-96W24V4000KIP20	○ 4000k	1061 lm	
EPRO-96W24V6500KIP20	● 6500k	1041 lm	
EPRO-96W24V3000KIP67	● 3000k	974 lm	12,74 €
EPRO-96W24V4000KIP67	○ 4000k	1025 lm	
EPRO-96W24V6500KIP67	● 6500k	1011 lm	

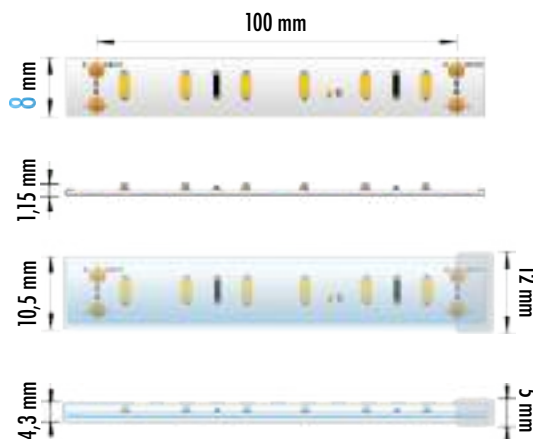

LED



EPRO 4.8W



A fita de 4.8W por metro foi concebida para aplicação em peças de mobiliário, iluminação ambiente ou para destacar a decoração e arquitetura do espaço.

(ENG) The 4.8W LED per meter LED strip was designed for application in pieces of furniture, ambient lighting or to highlight the decoration and architecture of the space.

(FR) La bande LED de 4,8 W par mètre à été conçu pour une application dans des meubles, un éclairage d'ambiance ou pour mettre en valeur la décoration et l'architecture de l'espace.

	Referência Reference Référence	Temperatura de cor Color temperature Température de couleur	Intensidade luminosa (lm) Light Intensity Intensité lumineuse	PVP P/m	
12V IP20	EPRO-48W12V3000KIP20	● 3000k	498 lm	6,50 €	
	EPRO-48W12V4000KIP20	○ 4000k	531 lm		
	EPRO-48W12V6500KIP20	● 6500k	531 lm		
12V IP67	EPRO-48W12V3000KIP67	● 3000k	496 lm	11,02 €	
	EPRO-48W12V4000KIP67	○ 4000k	529 lm		
	EPRO-48W12V6500KIP67	● 6500k	529 lm		
24V IP20	EPRO-48W24V3000KIP20	● 3000k	498 lm	6,50 €	
	EPRO-48W24V4000KIP20	○ 4000k	531 lm		
	EPRO-48W24V6500KIP20	● 6500k	531 lm		
24V IP67	EPRO-48W24V3000KIP67	● 3000k	496 lm	11,02 €	
	EPRO-48W24V4000KIP67	○ 4000k	529 lm		
	EPRO-48W24V6500KIP67	● 6500k	529 lm		



EPRO 24W CCT

24h/7
 50.000h
 180°
 +/-
 120 LEDs/m
 CRI > 90
 Rolo / Roll / Rouleau 5m
 CCT MULTI-WHITE LIGHTING
 3Step MacKöten

Uma solução versátil que permite variar entre 2200K e 6500K com apenas um clique. Com até 24W por metro, pode optar pela melhor cor sem comprometer a intensidade luminosa.

(ENG) A versatile solution that lets you change between 2200K and 6500K with just one click. With up to 24W per meter, you can choose the best color without compromising light intensity.

(FR) Une solution polyvalente qui vous permet de varier entre 2200K et 6500K en un seul clic. Avec jusqu'à 24 W par mètre, vous pouvez choisir la meilleure couleur sans compromettre l'intensité lumineuse.

Referência Reference Référence	Temperatura de cor Color temperature Température de couleur	Intensidade luminosa (lm) Light Intensity Intensité lumineuse	PVP P/m
--------------------------------------	-------------------------------------------------------------------	---------------------------------------------------------------------	------------

24V
IP20

EPRO-24W24VCCTIP20

CCT
 2200k - 6500k

- 12W - 2200k - 960 lm
- 12W - 6500k - 1140 lm
- 24W - Mix - 2160lm

10,15 €

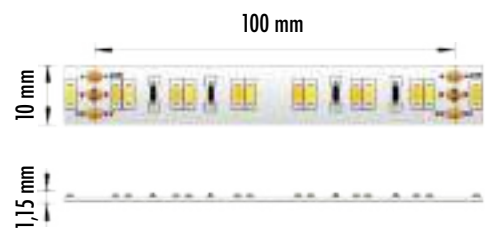



EPRO 19.2W RGB+W



Concebida para iluminar, criar ambientes e ser versátil, a fita de 19.2W por metro com 60 Leds RGB e 60 Leds de 3000K/4000K/6500K é a solução indicada. Ideal para todos os espaços e ambientes.

(ENG) Designed to illuminate, create environments and be versatile, the 19.2W per meter LED strip with 60 RGB LEDs and 60 LEDs from 3000K to 6500K is the right solution. Ideal for all spaces and environments.

(FR) Conçu pour éclairer, créer des environnements et être polyvalent, la bande de 19,2W par mètre avec 60 LEDs RVB et 60 LEDs de 3000K à 6500K est la bonne solution. Idéale pour tous les espaces et environnements.

24V IP20

Referência Reference Référence	Temperatura de cor Color temperature Température de couleur	Intensidade luminosa (lm) Light Intensity Intensité lumineuse	PVP P/m
EPRO-192W24VRGB3000KIP20	● 625 nm	58 lm	25,25 €
	● 523 nm	245 lm	
	● 469 nm	66 lm	
	● 3000k	512 lm	
EPRO-192W24VRGB4000KIP20	○ 4000k	528 lm	
EPRO-192W24VRGB6500KIP20	● 6500k	546 lm	

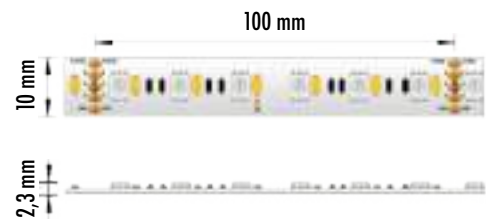

24V IP67

EPRO-192W24VRGB3000KIP67	● 625 nm	57 lm	28,51 €
	● 523 nm	238 lm	
	● 469 nm	64 lm	
	● 3000k	467 lm	
EPRO-192W24VRGB4000KIP67	○ 4000k	510 lm	
EPRO-192W24VRGB6500KIP67	● 6500k	530 lm	





EPRO 24W RGB+CCT



A fita de 24W por metro com 60 Leds RGB, 60 Leds de 2700K e 60 Leds de 6500K, é uma solução única no mercado de fitas. Ideal para todos os espaços e ambientes. Todas as cores numa só fita.

(ENG) The 24W per meter ribbon with 60 RGB LEDs, 60 2700K LEDs and 60 6500K LEDs, is a unique solution in the Leds strips market. Ideal solution for all spaces and environments. All colors in one Led stripe.

(FR) Le ruban 24W par mètre avec 60 Leds RVB, 60 Leds de 2700K et 60 Leds 6500K, est une solution unique sur le marché des rubans. Idéale pour tous les espaces et environnements. Toutes les couleurs dans un seul ruban.

24V
IP20

Referência Reference Référence	Temperatura de cor Color temperature Température de couleur	Intensidade luminosa (lm) Light Intensity Intensité lumineuse	PVP P/m
EPRO-24W24VRGBCCTIP20	● 625 nm	86 lm	26,65 €
	● 523 nm	21 lm	
	● 469 nm	23 lm	
	● 2700k	534 lm	
	● 6500k	580 lm	

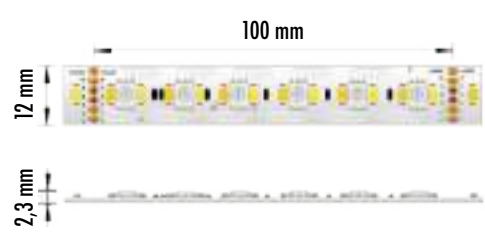



EPRO 14.4W RGB DIGITAL



Fita RGB Digital de 14.4W por metro de alta eficiência e fluxo luminoso. Programe os melhores efeitos para animar os seus ambientes. Indicada para espaços festivos, mobiliário de exposição e decoração de ambientes interiores ou exteriores. A fita pode ser cortada Led a Led, garantindo uma instalação à medida.

(ENG) 14.4W Digital RGB tape per meter with high efficiency and luminous flux. Program the best effects to liven up your environments. Indicated for festive spaces, exhibition furniture and decoration of indoor or outdoor environments. The tape can be cut Led to Led, ensuring a bespoke installation.

(FR) Ruban RVB Digital de 14,4 W par mètre à une haute efficacité et flux lumineux. Programmez les meilleurs effets pour animer vos environnements. Indiqué pour les espaces festifs, le mobilier d'exposition et la décoration d'environnements intérieurs ou extérieurs. Le ruban peut être découpé de Led à Led, assurant une installation sur mesure.

12V
IP20

Referência Reference Référence	Temperatura de cor Color temperature Température de couleur	Intensidade luminosa (lm) Light Intensity Intensité lumineuse	PVP P/m
EPRO-144W12VRGBDIGITALIP20	● 620 - 630 nm	40 lm	30,85 €
	● 520 - 530 nm	150 lm	
	● 465 - 475 nm	29 lm	
	● RGB	231.6 lm	





EPRO 14.4W RGB



Uma fita RGB de 14.4W por metro de alta eficiência e fluxo luminoso. Tenha a luz e cor que procura para animar os seus ambientes. Indicada para espaços festivos, mobiliário de exposição e decoração de ambientes interiores ou exteriores.

(ENG) One LED strip with 14.4W RGB per meter of high efficiency and luminous flux. Bring the light and color you are looking for to liven up your environments. Suitable for festive spaces, exhibition furniture and interior or exterior decoration.

(FR) La bande LED RVB de 14,4 W par mètre, a un haut niveau d'efficacité et de flux lumineux. Apportez la lumière et la couleur que vous recherchez pour animer vos environnements. Convient pour les espaces festifs, le mobilier d'exposition et la décoration intérieure ou extérieure.

24V
IP20

Referência Reference Référence	Temperatura de cor Color temperature Température de couleur	Intensidade luminosa (lm) Light Intensity Intensité lumineuse	PVP P/m
EPRO-144W24VRGBIP20	● 625 nm	58 lm	15,12 €
	● 523 nm	245 lm	
	● 469 nm	66 lm	

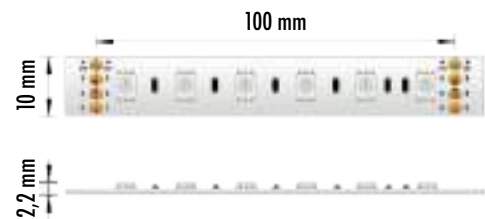

24V
IP67

EPRO-144W24VRGBIP67	● 625 nm	57 lm	18,04 €
	● 523 nm	238 lm	
	● 469 nm	64 lm	



HQS 14.4W RGB

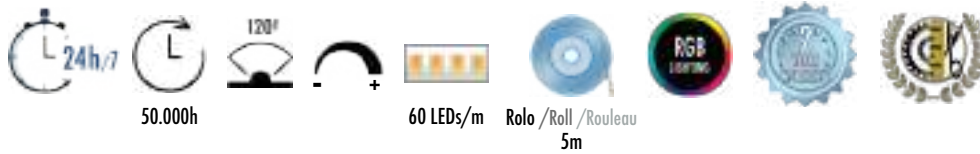

Fita RGB preparada para instalações rigorosas com IP33. Altamente competitiva, mantendo os mais altos padrões de qualidade.

(ENG) RGB tape prepared for rigorous installations with IP33. Highly competitive, maintaining the highest quality standards.

(FR) Ruban RVB préparé pour des installations rigoureuses avec IP33. Très compétitif, en gardant les hautes critères de qualité.

24V
IP33

Referência Reference Référence	Temperatura de cor Color temperature Température de couleur	Intensidade luminosa (lm) Light Intensity Intensité lumineuse	PVP P/m
HQS-144W24VRGBIP33	● 625 nm	115 lm	11,05 €
	● 525 nm	240 lm	
	● 465 nm	67 lm	

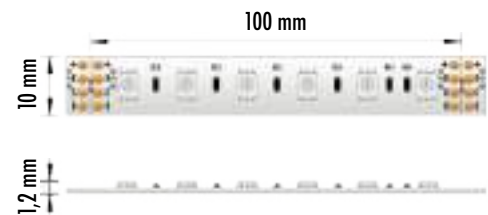



EPRO S 7.2W



Fita preparada para instalações difíceis. Permite fazer ângulos e cortes de 25mm em 25mm. Disponível em 8 cores diferentes.

(ENG) Led strip prepared for difficult installations. Allows you to make angles and cuts from 25mm to 25mm. Available in 8 different colors.

(FR) Bande led préparée pour les installations difficiles. Permet de réaliser des angles et des coupes de 25mm à 25mm. Disponible en 8 couleurs différentes.

Referência Reference Référence	Temperatura de cor Color temperature Température de couleur	Intensidade luminosa (lm) Light Intensity Intensité lumineuse	PVP P/m
EPRO-S72W12V3200KIP65	● 3200k	840 lm - 960 lm	5,20 €
EPRO-S72W12V4500KIP65	○ 4500k	840 lm - 960 lm	5,20 €
EPRO-S72W12V6500KIP65	● 6500k	840 lm - 960 lm	5,20 €
EPRO-S72W12VBLUEIP65	● BLUE	—————	5,20 €
EPRO-S72W12VGREENIP65	● GREEN	—————	5,20 €
EPRO-S72W12VYELLOWIP65	● YELLOW	—————	5,20 €
EPRO-S72W12VREDIP65	● RED	—————	5,20 €
EPRO-S72W12VPINKIP65	● PINK	—————	5,20 €

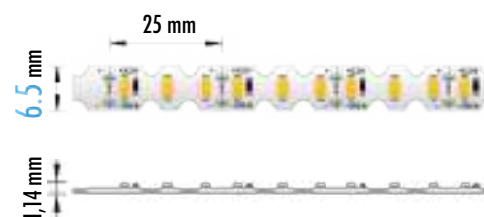

12V
IP65





EPRO S LENS 16W



Fita com lentes de 175°, permite a retro-iluminação de vidros, acrílicos, telas e pedras a uma curta distância sem se verem os pontos.

(ENG) Led strip with 175° lenses, allows the backlighting of glass, acrylics, canvas and stones at a short distance without seeing the points.

(FR) Ruban avec lentilles 175°, permet le rétroéclairage du verre, de l'acrylique, de la toile et des pierres à courte distance sans voir les points.

Referência Reference Référence	Temperatura de cor Color temperature Température de couleur	Intensidade luminosa (lm) Light Intensity Intensité lumineuse	PVP P/m
--------------------------------------	-------------------------------------------------------------------	---------------------------------------------------------------------	------------

24V
IP44

EPRO-SLENS16W24V11000KIP44	● 11000k	1600 lm	44,36 €
----------------------------	----------	---------	---------

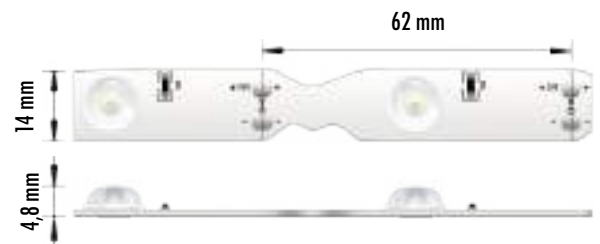



e⁺ NEON

EPLUS NEON, é uma gama de Neon Led de fabrico europeu. Garantimos até 5 anos de funcionamento sem interrupções. Concebido para as utilizações mais diversas, o tubo tem alta resistência às condições climatéricas e aos raios UV, garantindo-lhe até 5 anos sem alterações na cor. Os nossos tubos de Neon são fabricados por medida para garantir que tudo corre bem com a sua instalação. Consulte-nos para obter mais informações sobre o fabrico à medida dos seus projetos.

(ENG) EPLUS NEON is a range of European-made Neon Leds. We guarantee up to 5 years of uninterrupted operation. Designed for the most diverse uses, the tube is highly resistant to weather conditions and UV rays, guaranteeing you up to 5 years without color changes.

Our Neon tubes are custom-made to ensure everything runs smoothly with your installation.

Contact us for more information on tailor-made manufacturing for your projects.

(FR) EPLUS NEON est une gamme de Leds Néon de fabriquée en Europe. Nous garantissons jusqu'à 5 ans de fonctionnement ininterrompu. Conçu pour les usages les plus divers, le tube est très résistant aux intempéries et aux rayons UV, vous garantissant jusqu'à 5 ans sans changement de couleur. Nos tubes néon sont fabriqués sur mesure pour garantir que tout se passe bien avec votre installation. Contactez-nous pour plus d'informations sur la fabrication sur mesure de vos projets.

NEON

NEON MINI-CUT
11W

71



NEON S
9.6W

72



NEON M
9.6W

73



NEON L
9.6W

74



NEON L
14.4W
RGB

75



NEON L
19.2W
RGB+W

76



SIMBOLOGIA

(ENG) SYMBOLOGY (FR) SYMBOLOGIE

NEON



Funcionamento Ininterrupto
(ENG) Uninterrupted Operation
(FR) Fonctionnement Ininterrompu



Vida Útil
(ENG) Lifespan
(FR) Durée de vie



Ângulo de abertura
(ENG) Opening angle
(FR) Angle d'ouverture



Dimável
(ENG) Dimable
(FR) Dimmable



LEDs/m

Nº de Leds por Metro
(ENG) Number of LEDs per Meter
(FR) Nombre de LEDs par Mètre



Índice de Reprodução Cromática
(ENG) Color Rendering Index
(FR) Indice de Rendu de Couleur



Zonas de corte
(ENG) Cutting places
(FR) Endroits de coupe



Nº de Metros por rolo
(ENG) Number of Meters per roll
(FR) Nombre de Mètres par rouleau



RGB



RGB+W



Resistente aos raios UV
(ENG) Resistant to UV rays
(FR) Résistant aux rayons UV



Espessura da Pista de Cobre
(ENG) Copper Runway Thickness
(FR) Épaisseur de la Piste en Cuivre

IP65

À prova de poeiras e proteção contra jatos de água
(ENG) Dust proof and water jet protection
(FR) Anti-poussière et protection contre les jets d'eau

IP67

À prova de poeiras e proteção contra imersão temporária em água
(ENG) Dust proof and protection against temporary immersion in water
(FR) Anti-poussière et protection contre l'immersion temporaire dans l'eau



Anos de Garantia
(ENG) Years Warranty
(FR) Années de Garantie



Anos de Garantia da Fita Led
(ENG) Led Strip Warranty Years
(FR) Années de Garantie du Ruban LED



Anos de Garantia da Tubo Neon
(ENG) Tube Neon Years Warranty
(FR) Tube Néon Années de Garantie



Chip SAMSUNG 2835
(ENG) SAMSUNG 2835 Chip
(FR) Puce SAMSUNG 2835



Certificado 3 Step MacAdam



Corte GRATUITO
(ENG) FREE cutting
(FR) Coupe GRATUITE



Certificado RoHS compliant
(ENG) RoHS compliant Certificate
(FR) Certificat RoHS compliant



Conformidade com as diretivas legais vigentes na Europa
(ENG) Compliance with legal directives in Europe
(FR) Conformité aux directives légales en vigueur en Europe



Impróprio ao lixo comum
(ENG) Inappropriate for common garbage
(FR) Inapproprié pour les ordures ménagères



NEON MINI-CUT



Com o seu feixe de luz forte e uniforme e extrema flexibilidade, poderá elaborar letras, contornos, formas elaboradas ou logótipos com extrema facilidade, podendo ser cortado a cada 1 cm (LED a LED)

(ENG) With its strong and uniform light beam and extreme flexibility, you can create letters, outlines, elaborate shapes or logos with extreme ease, can be cut every 1 cm (LED to LED)

(FR) Avec son faisceau lumineux puissant et uniforme et son extrême flexibilité, vous pouvez créer des lettres, des contours, des formes élaborées ou des logos avec une extrême facilité, peuvent être découpés tous les 1 cm (LED à LED).

NEON

Referência Reference Référence	Temperatura de cor Color temperature Température de couleur	Intensidade luminosa (lm) Light Intensity Intensité lumineuse	PVP P/m
NEON-MC11W12V3000KIP65	● 3000k	220 lm	16,19 €
NEON-MC11W12V4000KIP65	○ 4000k	230 lm	
NEON-MC11W12V6000KIP65	● 6000k	240 lm	
NEON-MC11W12VREDIP65	● 88000 mcd	66 lm	
NEON-MC11W12VGREENIP65	● 152000 mcd	115 lm	
NEON-MC11W12VBLUEIP65	● 31200 mcd	24 lm	

11W
12V



IP65

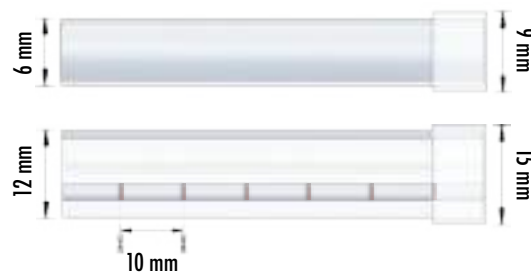

Acessórios Accessories/ Accessoires

Referência Reference / Référence	Descrição Description	PVP
NEON-MCCLIP	Clip de Fixação Fixation Clip / Clip de Fixation	0,65 €
NEON-MCEND	Tampa Final End Cap / Embout	0,75 €





NEON S



50.000h

120 LEDs/m

> 80

Corte/ Cut/ Découpe
50 - 50 mm

RESISTENCE

TUBO Neon
Neon TUBE
TUBE Neon

FITA Led
Led STRIP
RUBAN Led



Tubo Neon super fino. Com apenas 4mm de largura é a solução ideal para criar publicidade, letras e outras formas. Também indicado para mobiliário.

(ENG) Super thin Neon tube. Only 4mm wide it is the ideal solution for creating advertising, letters and other shapes. Also suitable for furniture.

(FR) Tube Neon super fin. Seulement 4 mm de diamètre c'est la solution idéale pour des créations publicitaires, des lettres et d'autres formes. Convient également pour les meubles.

Referência Reference Référence	Temperatura de cor Color temperature Température de couleur	Intensidade luminosa (lm) Light Intensity Intensité lumineuse	PVP P/m
NEON-S96W24V3000KIP67	● 3000k	271 lm	30,79 €
NEON-S96W24V4000KIP67	○ 4000k	288 lm	
NEON-S96W24V6500KIP67	● 6500k	282 lm	45,82 €
NEON-S96W24VREDIP67	● 88000 mcd	69 lm	
NEON-S96W24VGREENIP67	● 152000 mcd	120 lm	
NEON-S96W24VBLUEIP67	● 31200 mcd	25 lm	
NEON-S96W24VYELLOWIP67	● 112000 mcd	88 lm	

9.6W
24V



IP67

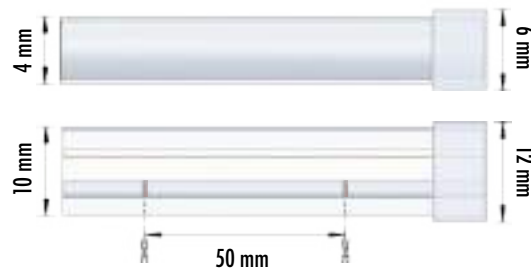

Accesórios Accessories/ Accessoires

Referência Reference / Référence	Descrição Description	PVP
NEON-SCLIP	Clip de Fixação Fixation Clip / Clip de Fixation	1,77 €
NEON-SEND	Tampa Final End Cap / Embout	0,75 €
NEON-SENDF	Tampa Final com ligação frontal End Cap with front connection Embout avec connexion frontale	0,75 €



FABRICADO POR MEDIDA (Min - 1m | Máx - 10m)

(ENG) CUSTOM-MADE (Min - 1m | Max - 10m)

(FR) FABRIQUER SUR MESURE (Min - 1m | Max - 10m)





NEON M



50.000h



120 LEDs/m

CRI

> 80



Corte/ Cut/ Découpe
50 - 50 mm



RESISTENCE



40Z



TUBO Neon
Neon TUBE
TUBE Neon



FITA Led
Led STRIP
RUBAN Led



Solução indicada para linhas perfeitas de iluminação no exterior como no interior. Ideal para criar limites e contornos.

(ENG) Solution indicated for perfect lines of exterior and interior lighting. Ideal for creating boundaries and contours

(FR) Solution indiquée pour avoir des lignes d'éclairage parfaites, à l'extérieur et l'intérieur. Idéal pour créer des bordures et des contours.

NEON

9.6W
24V

Referência Reference Référence	Temperatura de cor Color temperature Température de couleur	Intensidade luminosa (lm) Light Intensity Intensité lumineuse	PVP P/m
NEON-M96W24V3000KIP67	● 3000k	260 lm	36,16 €
NEON-M96W24V4000KIP67	○ 4000k	276 lm	
NEON-M96W24V6500KIP67	● 6500k	271 lm	
NEON-M96W24VREDIP67	● 88000 mcd	66 lm	
NEON-M96W24VGREENIP67	● 152000 mcd	115 lm	
NEON-M96W24VBLUEIP67	● 31200 mcd	24 lm	
NEON-M96W24VYELLOWIP67	● 112000 mcd	85 lm	



IP67

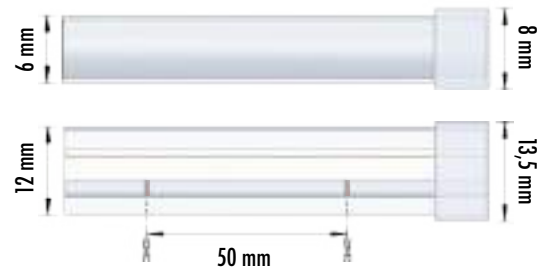

Accesórios Accessories/ Accessoires

Referência Reference / Référence	Descrição Description	PVP
NEON-MCLIP	Clip de Fixação Fixation Clip / Clip de Fixation	1,77 €
NEON-MEND	Tampa Final End Cap / Embout	1,04 €
NEON-MENDF	Tampa Final com ligação frontal End Cap with front connection Embout avec connexion frontal	1,04 €



FABRICADO POR MEDIDA (Min - 1m | Máx - 10m)
(ENG) CUSTOM-MADE (Min - 1m | Max - 10m)
(FR) FABRIQUER SUR MESURE (Min - 1m | Max - 10m)





NEON L



50.000h

120 LEDs/m

CRI > 80

Corte/ Cut/ Découpe
50 - 50 mm

RESISTENCE

40Z



TUBO Neon
Neon TUBE
TUBE Neon



FITA Led
Led STRIP
RUBAN Led



Tubo Neon largo para maior luminosidade e destaque arquitetónico. Permite criar linhas sem interrupções, tanto no interior como no exterior do seu espaço.

(ENG) Wide Neon tube for greater luminosity and architectural highlight. It allows you to create lines without interruptions, both inside and outside your space.

(FR) Tube Neon large pour une plus grande luminosité et une mise en valeur architecturale. Il vous permet de créer des lignes sans interruption, tant à l'intérieur qu'à l'extérieur de votre espace.

Referência Reference Référence	Temperatura de cor Color temperature Température de couleur	Intensidade luminosa (lm) Light Intensity Intensité lumineuse	PVP P/m
NEON-L96W24V3000KIP67	● 3000k	509 lm	52,77 €
NEON-L96W24V4000KIP67	○ 4000k	541 lm	
NEON-L96W24V6500KIP67	● 6500k	530 lm	68,13 €
NEON-L96W24VREDIP67	● 88000 mcd	130 lm	
NEON-L96W24VGREENIP67	● 152000 mcd	225 lm	
NEON-L96W24VBLUEIP67	● 31200 mcd	46 lm	
NEON-L96W24VYELLOWIP67	● 112000 mcd	165 lm	

9.6W
24V



IP67

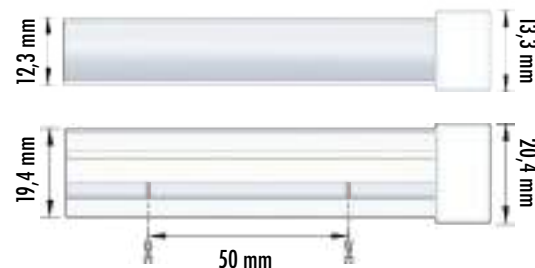

Acessórios Accessories/ Accessoires

Referência Reference / Référence	Descrição Description	PVP
NEON-LCLIP	Clip de Fixação Fixation Clip / Clip de Fixation	2,64 €
NEON-LEND	Tampa Final End Cap / Embout	2,04 €
NEON-LENDF	Tampa Final com ligação frontal End Cap with front connection Embout avec connexion frontale	2,04 €
NEON-LENDL	Tampa Final com ligação lateral End Cap with side connection / Embout avec connexion de côté	2,04 €



FABRICADO POR MEDIDA (Min - 1m | Máx - 10m)

(ENG) CUSTOM-MADE (Min - 1m | Max - 10m)

(FR) FABRIQUER SUR MESURE (Min - 1m | Max - 10m)





NEON L RGB



NEON

Tubo Neon RGB com alta intensidade luminosa e cores perfeitas. Preparado para colorir o seu espaço no exterior ou interior. Solução ideal para publicidade.

(ENG) Neon RGB tube with high luminous intensity and perfect colors. Ready to color your outdoor or indoor space. Ideal solution for advertising.

(FR) Tube Neon RGB avec une intensité lumineuse élevée et des couleurs parfaites. Prêt à colorer votre espace extérieur ou intérieur. Solution idéale pour la publicité.

Referência Reference Référence	Temperatura de cor Color temperature Température de couleur	Intensidade luminosa (lm) Light Intensity Intensité lumineuse	PVP P/m
--------------------------------------	-------------------------------------------------------------------	---------------------------------------------------------------------	------------

**14.4W
24V**

NEON-L144W24VRGBIP67	● 8482 mcd	27 lm	51,48 €
	● 35568 mcd	112 lm	
	● 9576 mcd	30 lm	



IP67

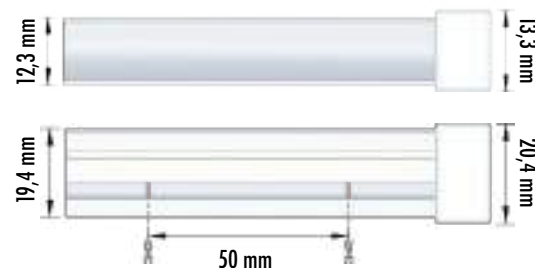

Accesórios Accessories/ Accessoires

Referência Reference / Référence	Descrição Description	PVP
NEON-LRGBCLIP	Clip de Fixação Fixation Clip / Clip de Fixation	2,64 €
NEON-LRGBEND	Tampa Final End Cap / Embout	2,04 €
NEON-LRGBENDF	Tampa Final com ligação frontal End Cap with front connection Embout avec connexion frontale	2,04 €
NEON-LRGBENDL	Tampa Final com ligação lateral End Cap with side connection / Embout avec connexion de côté	2,04 €

★ **FABRICADO POR MEDIDA (Min - 1m | Máx - 10m)**
(ENG) CUSTOM-MADE (Min - 1m | Max - 10m)
(FR) FABRIQUER SUR MESURE (Min - 1m | Max - 10m)





NEON L RGB+W



Tube Neon RGB+W com 120 leds por metro para criar linhas perfeitas e escolher a cor mais adequada ao momento.

(ENG) RGB+W tube with 120 leds per meter to create perfect lines and choose the most appropriate color for the moment.

(FR) Tube Neon RGB+W avec 120 leds par mètre pour créer des lignes parfaites et choisir la couleur la plus appropriée pour le moment présent.

Referência Reference Référence	Temperatura de cor Color temperature Température de couleur	Intensidade luminosa (lm) Light Intensity Intensité lumineuse	PVP P/m
	● 8482 mcd	27 lm	63,29 €
	● 35568 mcd	115 lm	
	● 9576 mcd	31 lm	
	● 3000k	241 lm	
NEON-L192W24VRGB3000KIP67	○ 4000k	257 lm	
NEON-L192W24VRGB4000KIP67	● 6500k	257 lm	
NEON-L192W24VRGB6500KIP67			

19.2W
24V



IP67

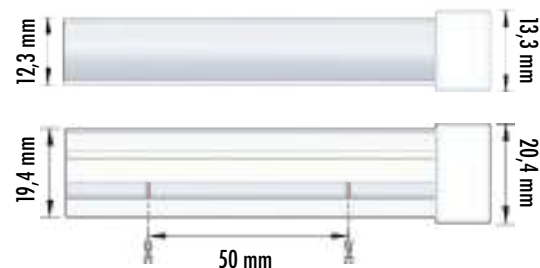

Acessórios Accessories/ Accessoires

Referência Reference / Référence	Descrição Description	PVP
NEON-LRGBWCLIP	Clip de Fixação Fixation Clip / Clip de Fixation	2,64 €
NEON-LRGBWEND	Tampa Final End Cap / Embout	2,04 €
NEON-LRGBWENDF	Tampa Final com ligação frontal End Cap with front connection Embout avec connexion frontal	2,04 €
NEON-LRGBWENDL	Tampa Final com ligação lateral End Cap with side connection / Embout avec connexion de côté	2,04 €

★ FABRICADO POR MEDIDA (Min - 1m | Máx - 10m)
(ENG) CUSTOM-MADE (Min - 1m | Max - 10m)
(FR) FABRIQUER SUR MESURE (Min - 1m | Max - 10m)





e⁺ SIGN

EPLUS SIGN é uma linha de artigos concebidos para execução de todo o tipo de trabalhos publicitários. Segundo os mais rigorosos critérios de qualidade, os produtos EPLUS SIGN aliam a excelência à versatilidade. Uma gama capaz de fazer face a todos os desafios e apresentar magníficos resultados.

(ENG) EPLUS SIGN is a line of articles designed to carry out all types of advertising work. According to the strictest quality criteria, EPLUS SIGN products combine excellence with versatility. A range capable of meeting all challenges and delivering magnificent results.

(FR) EPLUS SIGN est une ligne d'articles conçue pour réaliser tous types de travaux publicitaires. Selon les critères de qualité les plus stricts, les produits EPLUS SIGN allient l'excellence à la polyvalence. Une gamme capable de relever tous les défis et d'acquiescer des magnifiques résultats.



SIGN

SIGN 001

81-83



0.36W

0.72W

1.08W



SIGN 002

84



32W

SIGN 003

85



5W

SIGN 004

86



1.2W

SIGN 005

87



0.72W

1.2W



SIGN 006

88-90



0,36W

0,48W

0,72W

SIGN 007

91



1.2W

SIGN 008

92



2W

SIGN 009

93



0.72W



SIGN 010

94



0.96W



SIGN 011

95



0.72W



SIGN 012

96



0.72W



SIGN 013

97



0.72W



SIGN 014

98



2.5W



SIGN NEON

99



SIGN

SIMBOLOGIA

(ENG) SYMBOLOGY (FR) SYMBOLOGIE



Mod. p/m

Número de Módulos por metro
(ENG) Number of Modules per meter
(FR) Nombre de Modules par mètre



Mod. p/Uni

Número de Módulos por unidade
(ENG) Number of Modules per unity
(FR) Nombre de Modules par unité



Vida Útil
(ENG) Lifespan
(FR) Durée de vie



Profundidade de Iluminação Direta
(ENG) Direct Lighting Depth
(FR) Profondeur d'Éclairage Direct



Profundidade de Iluminação Perimetral
(ENG) Perimeter Illumination Depth
(FR) Profondeur d'Éclairage Périmétrique



Ângulo de abertura
(ENG) Opening angle
(FR) Angle d'ouverture



Dimável
(ENG) Dimmable
(FR) Dimmable



Nº de unidades por embalagem
(ENG) Number of units per bag
(FR) Nombre d'unités par poche



Elevada Eficiência
(ENG) High Efficiency
(FR) Haut niveau d'Efficiency



RGB DIGITAL



RGB



RGB+W



CCT



Resistente aos raios UV
(ENG) Resistant to UV rays
(FR) Résistant aux rayons UV

IP65

À prova de poeiras e proteção contra jatos de água
(ENG) Dust proof and water jet protection
(FR) Anti-poussière et protection contre les jets d'eau

IP67

À prova de poeiras e proteção contra imersão temporária em água
(ENG) Dust proof and protection against temporary immersion in water
(FR) Anti-poussière et protection contre l'immersion temporaire dans l'eau



Controlador de Corrente Integrado (CCI)
(ENG) Integrated Current Controller (CCI)
(FR) Contrôleur de Courant Intégré (CCI)



Anos de Garantia
(ENG) Years Warranty
(FR) Années de Garantie



Corte GRATUITO
(ENG) FREE cutting
(FR) Coupe GRATUITE



Certificado RU
(ENG) RoHS compliant Certificate
(FR) Certificat RoHS compliant



Certificado RoHS compliant
(ENG) RoHS compliant Certificate
(FR) Certificat RoHS compliant



Conformidade com as diretivas legais vigentes na Europa
(ENG) Compliance with legal directives in Europe
(FR) Conformité aux directives légales en vigueur en Europe



Impróprio ao lixo comum
(ENG) Inappropriate for common garbage
(FR) Inapproprié pour les ordures ménagères

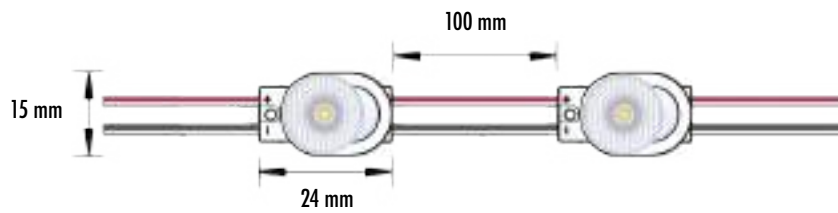

SIGN 001



SIGN

Módulo LED com uma estupenda eficiência (150lm/W), para aplicação em espaços de dimensões reduzidas.

(ENG) LED module with stupendous efficiency (150lm/W), for application in small spaces.

(FR) Module LED avec une efficacité prodigieuse (150lm/W), pour une application dans de petits espaces.

Referência Reference / Référence	Temperatura de cor Color temperature / Température de couleur	Potência Rated power / Puissance nominale	Intensidade luminosa (lm) Light Intensity / Intensité lumineuse	PVP
SIGN-001-036W-C	● 7000k - 8000k	0.36W	54 lm	0,88 €

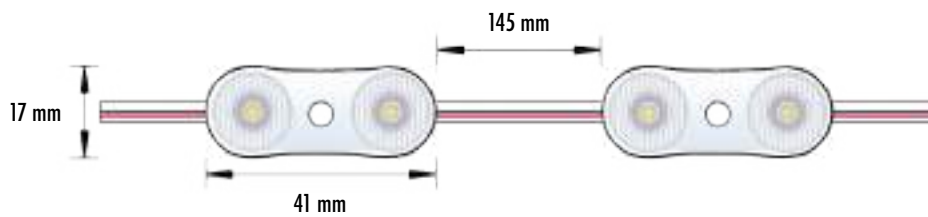

SIGN 001

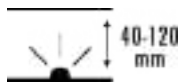

Módulo LED com uma estupenda eficiência (150lm/W) e com dimensões compactas que facilitam o manuseamento e instalação.

(ENG) LED module with stupendous efficiency (150lm/W) and compact dimensions that facilitate handling and installation.

(FR) Module LED avec une efficacité prodigieuse (150lm/W) et des dimensions compactes qui facilitent la manipulation et l'installation.

Referência Reference / Référence	Temperatura de cor Color temperature / Température de couleur	Potência Rated power / Puissance nominale	Intensidade luminosa (lm) Light Intensity / Intensité lumineuse	PVP
SIGN-001-072W-C	● 7000k - 8000k	0.72W	108 lm	1,27 €

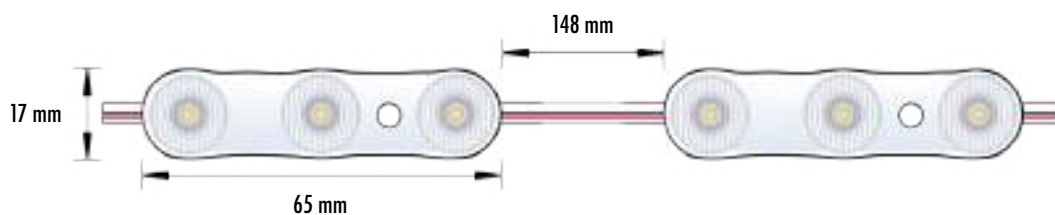

SIGN 001



Módulo LED com uma estupenda eficiência (150lm/W), para aplicação em letras mono-bloco ou caixas de luz de grande dimensão.

(ENG) LED module with a stupendous efficiency (150lm/W), for application in 3D channel letters or large light boxes.

(FR) Module LED avec une efficacité prodigieuse (150lm/W), pour une application dans des lettres monoblocs ou de grands caissons lumineux.

Referência Reference / Référence	Temperatura de cor Color temperature / Température de couleur	Potência Rated power / Puissance nominale	Intensidade luminosa (lm) Light Intensity / Intensité lumineuse	PVP
SIGN-001-108W-C	● 7000k - 8000k	1.08W	162 lm	1,67 €



SIGN 002

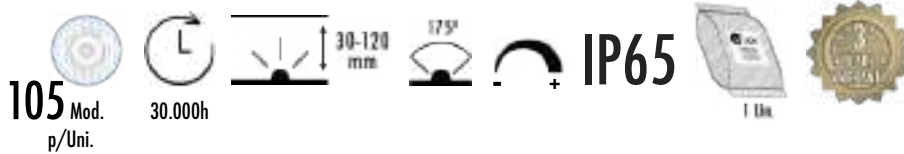

Módulo concebido para retro-iluminar superfícies a uma curta distância sem pontos visíveis (Ex. acrílico, tela, pedra).
 (ENG) Module designed to backlight surfaces at a short distance without visible points (eg acrylic, canvas, stone).
 (FR) Module conçu pour rétroéclairer des surfaces à courte distance sans points visibles (ex. acrylique, toile, pierre).

Referência Reference / Référence	Temperatura de cor Color temperature / Température de couleur	Potência Rated power / Puissance nominale	Intensidade luminosa (lm) Light Intensity / Intensité lumineuse	PVP
SIGN-002-32W-C	● 7000k	32W	3480 lm	134,03 €

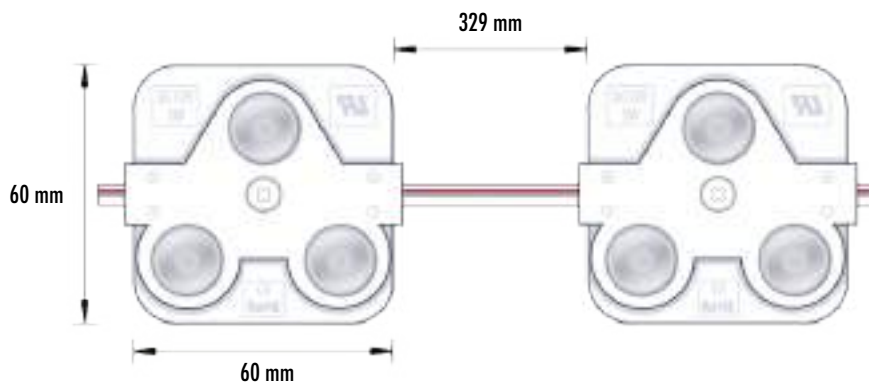

SIGN 003

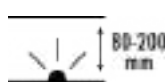

IP65



Módulo LED com elevada potência, para aplicação em caixas de luz de grande dimensão, garantindo uma iluminação intensa e uniforme.

(ENG) LED module with high power, for application in large light boxes, ensuring intense and uniform lighting.

(FR) Module LED à haute puissance, pour une application dans de grands caissons lumineux, assurant un éclairage intense et uniforme.

Referência Reference / Référence	Temperatura de cor Color temperature / Température de couleur	Potência Rated power / Puissance nominale	Intensidade luminosa (lm) Light Intensity / Intensité lumineuse	PVP
SIGN-003-5W-C	● 6500k	5W	500 lm	3,70 €

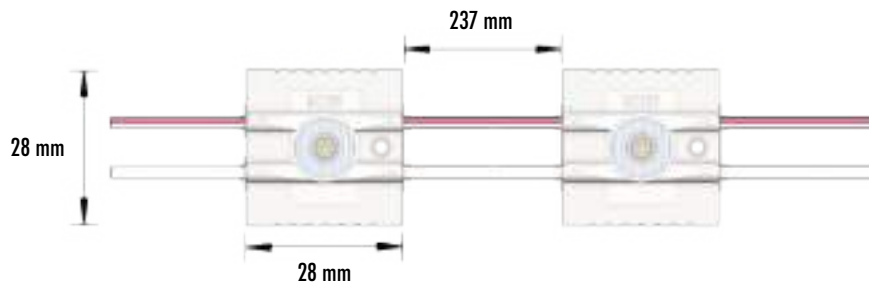

SIGN 004

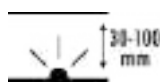

IP67



Módulo LED com a melhor relação qualidade-preço, para caixas de luz de qualquer dimensão.

(ENG) LED module with the best value for money, for light boxes of any size.

(FR) Module LED au meilleur rapport qualité-prix, pour caissons lumineux de toutes tailles.

Referência Reference / Référence	Temperatura de cor Color temperature / Température de couleur	Potência Rated power / Puissance nominale	Intensidade luminosa (lm) Light Intensity / Intensité lumineuse	PVP
SIGN-004-12W-C	● 6000k - 8000k	1.2W	100 lm	0,86 €

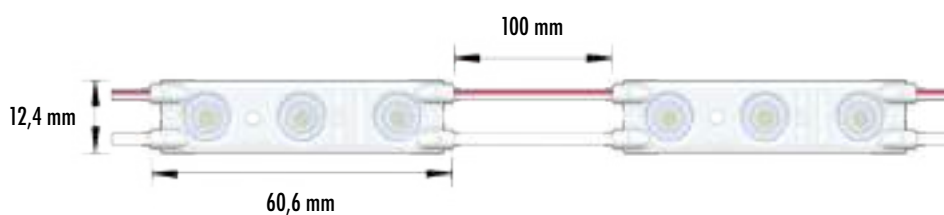

SIGN 005

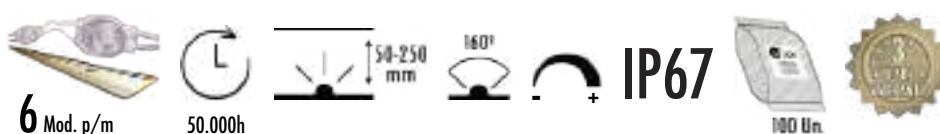

Módulo LED com excelente relação qualidade-preço, dimensões compactas que facilitam o manuseamento e a instalação, para caixas de luz ou letras mono-bloco.

(ENG) LED module with excellent value for money, compact dimensions that facilitate handling and installation, for application in 3D channel letters or light boxes.

(FR) Module LED avec un excellent rapport qualité-prix, des dimensions compactes qui facilitent la manipulation et l'installation, pour caissons lumineux ou lettres monobloc.

Referência Reference / Référence	Temperatura de cor Color temperature / Température de couleur	Potência Rated power / Puissance nominale	Intensidade luminosa (lm) Light Intensity / Intensité lumineuse	PVP
SIGN-005-072W-C	● 6000k - 7000k	0.72W	69 lm	0,69 €
SIGN-005-12W-C	● 6000k - 7000k	1.2W	114 lm	0,78 €

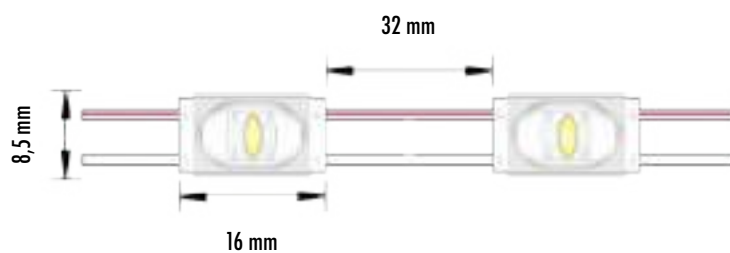

SIGN 006



20 Mod. p/m



50.000h

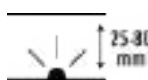

IP67



100 Un.



Módulo LED com dimensões extremamente compactas, facilitando a instalação em espaços apertados ou com necessidade de curvaturas acentuadas.

(ENG) LED module with extremely compact dimensions, facilitating installation in tight spaces or those in need of sharp bends..

(FR) Module LED aux dimensions extrêmement compactes, facilitant l'installation dans des espaces restreints et très courbés.

Referência Reference / Référence	Temperatura de cor Color temperature / Température de couleur	Potência Rated power / Puissance nominale	Intensidade luminosa (lm) Light Intensity / Intensité lumineuse	PVP
SIGN-006-036W-C	● 6000k - 7000k	0.36W	41 lm	0,79 €

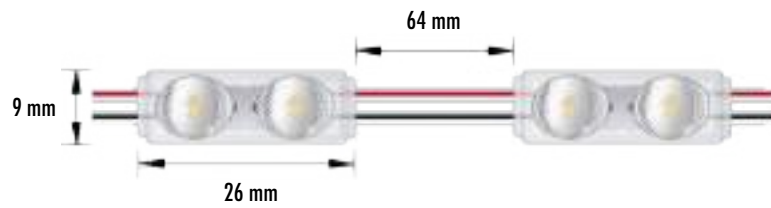

SIGN 006

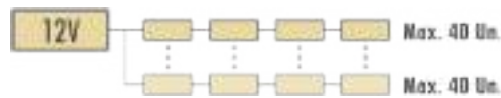

Módulo LED com dimensões extremamente compactas, facilitando a instalação em espaços apertados ou com necessidade de curvaturas acentuadas.
 (ENG) LED module with extremely compact dimensions, facilitating installation in tight spaces or those in need of sharp bends..
 (FR) Module LED aux dimensions extrêmement compactes, facilitant l'installation dans des espaces restreints et très courbés.

Referência Reference / Référence	Temperatura de cor Color temperature / Température de couleur	Potência Rated power / Puissance nominale	Intensidade luminosa (lm) Light Intensity / Intensité lumineuse	PVP
SIGN-006-048W-W	● 3000k	0.48W	50 lm	
SIGN-006-048W-N	○ 4000k	0.48W	50 lm	1,37 €
SIGN-006-048W-C	● 7000k	0.48W	50 lm	



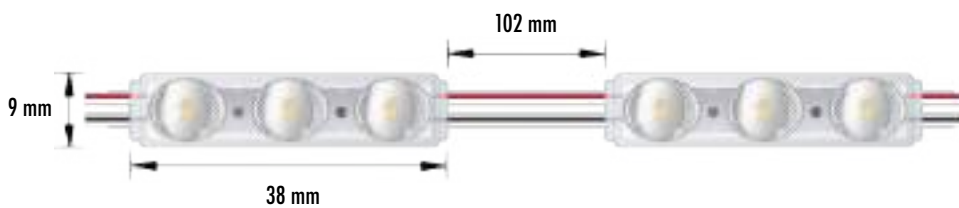

SIGN 006

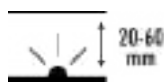

Módulo LED com dimensões extremamente compactas, facilitando a instalação em espaços apertados ou com necessidade de curvaturas acentuadas.

(ENG) LED module with extremely compact dimensions, facilitating installation in tight spaces or those in need of sharp bends..

(FR) Module LED aux dimensions extrêmement compactes, facilitant l'installation dans des espaces restreints et très courbés.

Referência Reference / Référence	Temperatura de cor Color temperature / Température de couleur	Potência Rated power / Puissance nominale	Intensidade luminosa (lm) Light Intensity / Intensité lumineuse	PVP
SIGN-006-072W-W	● 3000k	0.72W	80 lm	
SIGN-006-072W-N	○ 4000k	0.72W	80 lm	1,54 €
SIGN-006-072W-C	● 7000k	0.72W	80 lm	

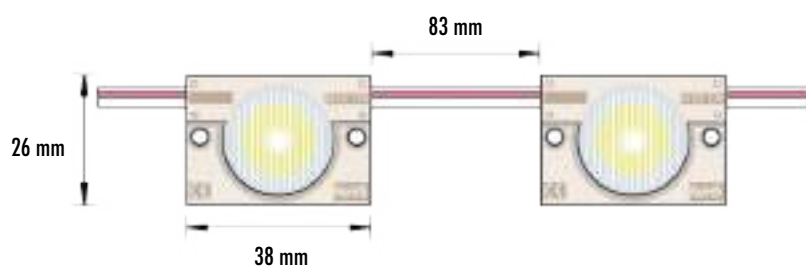

SIGN 007

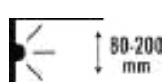
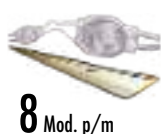

Módulo de LED para iluminação perimetral e dupla face, para caixas de luz de pequena e média dimensão.

(ENG) LED module for perimeter and double-sided lighting, for small and medium-sized light boxes.

(FR) Module LED pour éclairage périmétrique et double face, pour caissons lumineux de petite et moyenne taille.

Referência Reference / Référence	Temperatura de cor Color temperature / Température de couleur	Potência Rated power / Puissance nominale	Intensidade luminosa (lm) Light Intensity / Intensité lumineuse	PVP
SIGN-007-12W-C	● 6500K - 10 000K	1.2W	120 lm	1,21 €

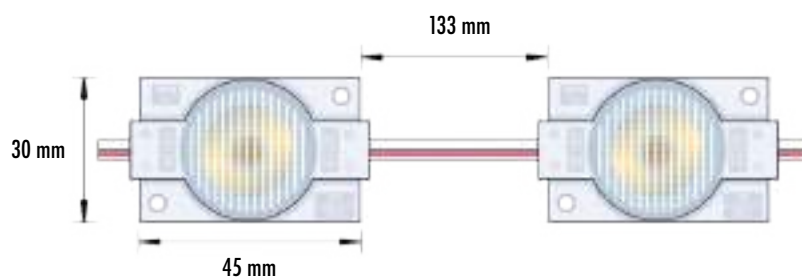

SIGN 008

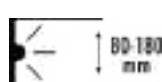
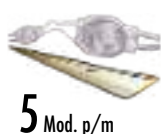

Módulo de LED para iluminação perimetral e dupla face, para caixas de luz com maior necessidade de intensidade luminosa.

(ENG) LED module for perimeter and double-sided lighting, for light boxes with a greater need for luminous intensity.

(FR) Module LED pour éclairage périmétrique et double face, pour caissons lumineux avec un plus grand besoin d'intensité lumineuse.

Referência Reference / Référence	Temperatura de cor Color temperature / Température de couleur	Potência Rated power / Puissance nominale	Intensidade luminosa (lm) Light Intensity / Intensité lumineuse	PVP
SIGN-008-2W-C	● 6500K	2W	160 lm	1,73 €

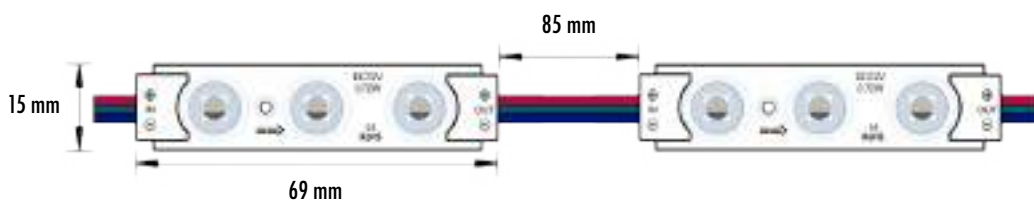

SIGN 009

SIGN



Módulo de LED RGB DIGITAL IC, que permite a atribuição de funções a cada módulo, como mudança de cor (RGB ou monocromático), ordem de reprodução, etc.
 (ENG) RGB DIGITAL IC LED module, which allows you to assign functions to each module, such as color change (RGB or monochrome), playback order, etc.
 (FR) Module LED RGB DIGITAL IC, qui permet d'attribuer des fonctions à chaque module, telles que le changement de couleur (RVB ou monochrome), l'ordre de lecture, etc.

Referência Reference / Référence	Temperatura de cor Color temperature / Température de couleur	Potência Rated power / Puissance nominale	Intensidade luminosa (lm) Light Intensity / Intensité lumineuse	PVP
SIGN-009-072W-DIGITAL	● RGB	0.72W	● 21.9lm , ● 25.5lm, ● 12.2lm ● 48.8lm	1,78 €

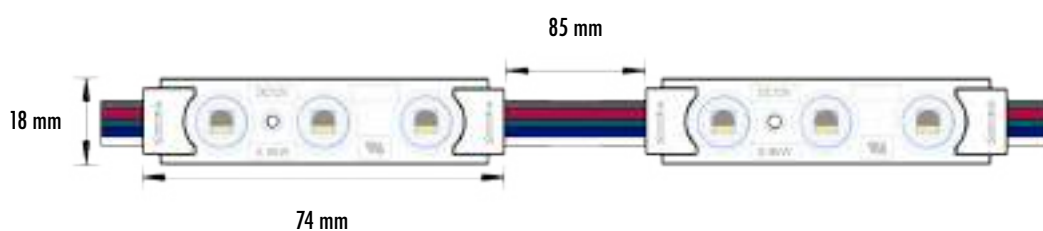
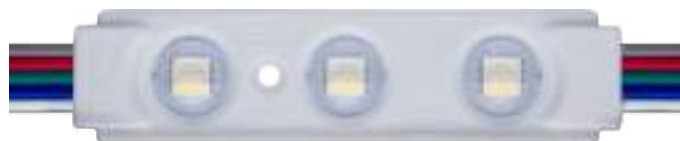

SIGN 010

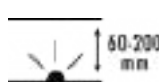

IP65



Módulo de LED RGB + W (6000K), que permite a mudança de cor ou alterar para monocromático, tudo no mesmo módulo.

(ENG) RGB + W LED module (6000K), which allows you to change color or change to monochrome, all in the same module.

(FR) Module LED RVB + W (6000K), qui permet de changer de couleur ou de passer en monochrome, le tout dans un même module.

Referência Reference / Référence	Temperatura de cor Color temperature / Température de couleur	Potência Rated power / Puissance nominale	Intensidade luminosa (lm) Light Intensity / Intensité lumineuse	PVP
SIGN-010-096W-RGBW	● RGB + ● 6000K	0.96W	● 6lm , ● 16lm , ● 3.5lm ● 18lm	2,15 €

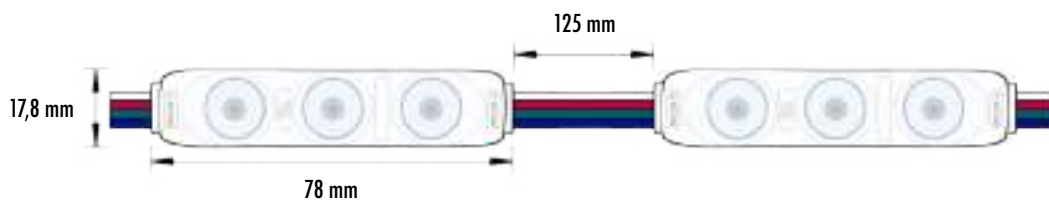

SIGN 011



IP65



Módulo de LED RGB, que permite a mudança de cor, conferindo um efeito luminoso de cariz decorativo.

(ENG) RGB LED module, which allows color change, providing a decorative luminous effect.

(FR) Module LED RVB, qui permet le changement de couleur, fournissant un effet lumineux décoratif.

Referência Reference / Référence	Temperatura de cor Color temperature / Température de couleur	Potência Rated power / Puissance nominale	Intensidade luminosa (lm) Light Intensity / Intensité lumineuse	PVP
SIGN-011-072W-RGB	● RGB	0.72W	● 5lm, ● 14lm, ● 3lm ● 21lm	1,67 €

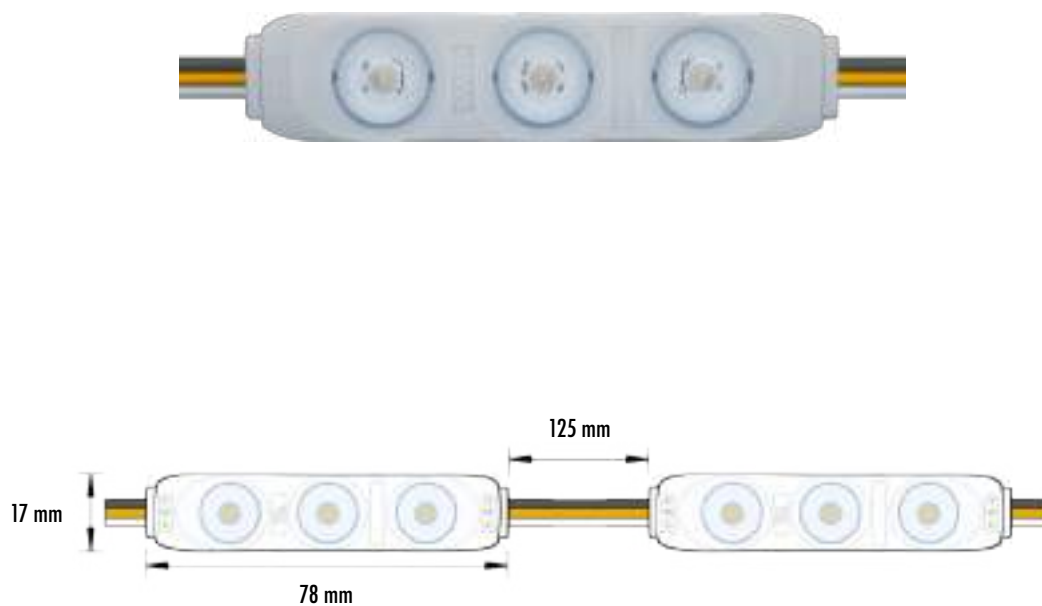

SIGN 012



Módulo de LED CCT, que permite a regulação da temperatura de cor com variação entre 2800K e 6500K, tudo no mesmo módulo.

(ENG) CCT LED module, which allows color temperature regulation ranging between 2800K and 6500K, all in the same module.

(FR) Module LED CCT, qui permet la régulation de la température de couleur allant de 2800K à 6500K, le tout dans un même module.

Referência Reference / Référence	Temperatura de cor Color temperature / Température de couleur	Potência Rated power / Puissance nominale	Intensidade luminosa (lm) Light Intensity / Intensité lumineuse	PVP
SIGN-012-072W-CCT	CCT (2800K - 6500K)	0.72W	63.5lm , 65lm	1,67 €

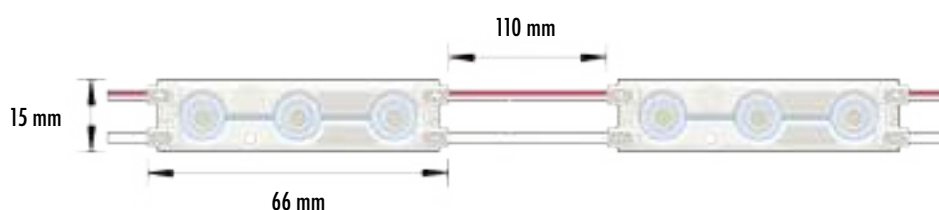

SIGN 013



Módulo de LED com dimensões compactas, para todas as necessidades de iluminação decorativa.

(ENG) LED module with compact dimensions, for all decorative lighting needs.

(FR) Module LED aux dimensions compactes, pour tous les besoins d'éclairage décoratif.

Referência Reference / Référence	Temperatura de cor Color temperature / Température de couleur	Potência Rated power / Puissance nominale	Intensidade luminosa (lm) Light Intensity / Intensité lumineuse	PVP
SIGN-013-072W-W	● 2700k - 3200k	0.72W	66 lm	1,21 €
SIGN-013-072W-N	○ 4000k	0.72W	66 lm	1,21 €
SIGN-013-072W-R	● 620 - 630nm	0.72W	66 lm	1,21 €
SIGN-013-072W-G	● 520 - 530nm	0.72W	66 lm	1,21 €
SIGN-013-072W-B	● 460 - 470nm	0.72W	66 lm	1,21 €

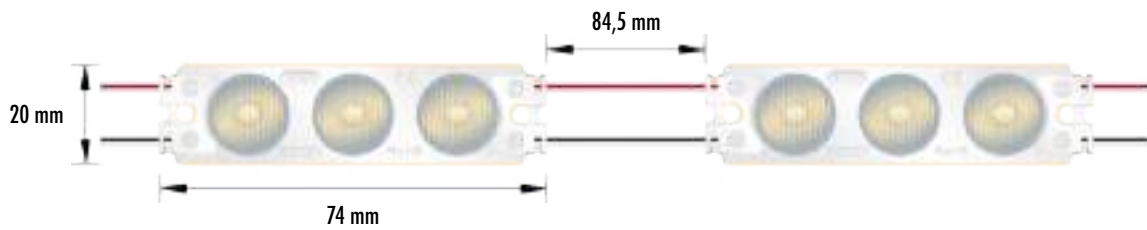

SIGN 014



IP67



Solução de luz perimetral de alta intensidade para instalações mais exigentes. Disponível em três cores.

(ENG) High intensity perimeter light solution for the most demanding installations. Available in three colors.

(FR) Solution d'éclairage périmétrique à haute intensité pour les installations les plus exigeantes. Disponible en trois couleurs.

Referência Reference / Référence	Temperatura de cor Color temperature / Température de couleur	Potência Rated power / Puissance nominale	Intensidade luminosa (lm) Light Intensity / Intensité lumineuse	PVP
SIGN-013-25W-W	● 2700k	2.5W	230 lm	
SIGN-013-25W-N	○ 4000k	2.5W	250 lm	2,72 €
SIGN-013-25W-C	● 7000K	2.5W	250 lm	

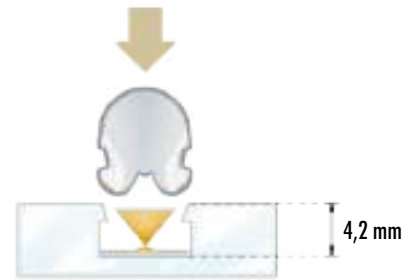
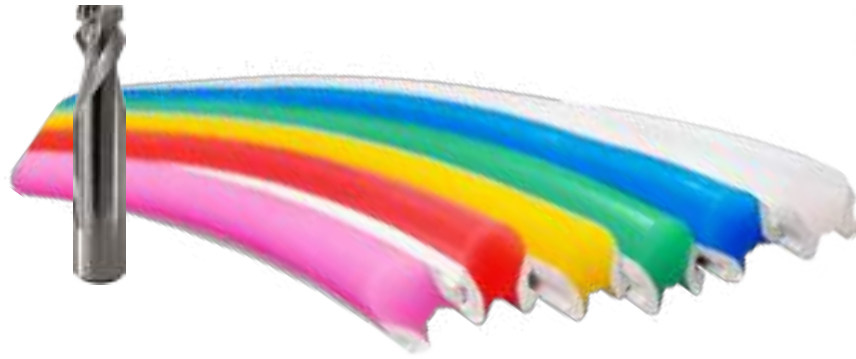

○ Acrílico (ENG) Acrylic (FR) Acrylique

SIGN NEON



Solução em silicone para encastrar, resistente aos UV para substituir o NEON. Super maleável, ideal para diversos trabalhos e superfícies. Disponível em 6 cores e em duas medidas.

(ENG) Silicone solution for recessed, UV resistant to replace NEON. Super malleable, ideal for different jobs and surfaces. Available in 6 colors and in two sizes.

(FR) Solution silicone pour encastré, résistant aux UV pour remplacer NEON. Super malléable, idéal pour différents travaux et surfaces. Disponible en 6 couleurs et en deux tailles.

	Referência Reference / Référence	Cor Color / Couleur	PVP P/m		Referência Reference / Référence	Cor Color / Couleur	PVP P/m
6mm	SIGN-NEON-6-W	○ WHITE	6 €	8mm	SIGN-NEON-8-W	○ WHITE	6,50 €
	SIGN-NEON-6-BLUE	● BLUE	6 €		SIGN-NEON-8-BLUE	● BLUE	6,50 €
	SIGN-NEON-6-GREEN	● GREEN	6 €		SIGN-NEON-8-GREEN	● GREEN	6,50 €
	SIGN-NEON-6-YELLOW	● YELLOW	6 €		SIGN-NEON-8-YELLOW	● YELLOW	6,50 €
	SIGN-NEON-6-RED	● RED	6 €		SIGN-NEON-8-RED	● RED	6,50 €
	SIGN-NEON-6-PINK	● PINK	6 €		SIGN-NEON-8-PINK	● PINK	6,50 €
	SIGN-NEON-6-FREZA		121,72 €		SIGN-NEON-8-FREZA		121,72 €

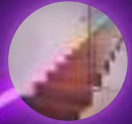
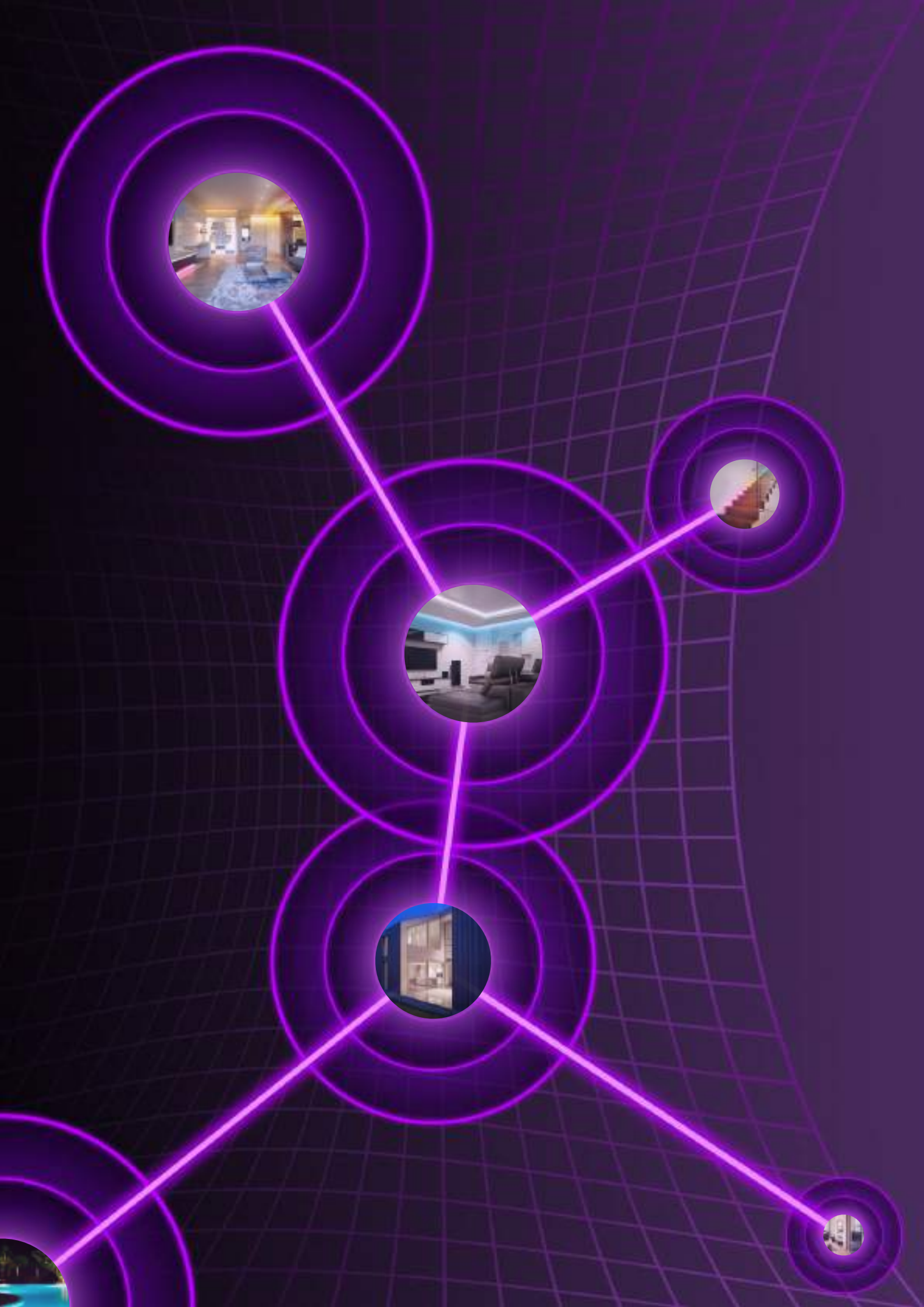



e⁺ CONTROL



EPLUS CONTROL é uma gama de artigos de controlo sem fios de alto rendimento, que inclui opções para controlar LED mono, CCT, RGB, RGBW, RGBW+CCT e RGB DIGITAL.

Permitindo a criação de modos de cores, estáticas ou em alternância de forma dinâmica, oferecendo várias opções na criação do ambiente desejado e possibilitando a adaptação aos diferentes momentos.

Este sistema de automação residencial, permite controlar remotamente várias zonas, sem limite de receptores e com sincronização perfeita. Os receptores podem ser controlados por RF, WiFi (via APP) ou voz (Amazon Alexa/Google Home).

(ENG) EPLUS CONTROL is a range of high-performance wireless control items, which includes options to control mono LED lighting, CCT, RGB, RGBW, RGBW+CCT and RGB DIGITAL.. Allowing the creation of color modes, static or alternating dynamically, offering several options in creating the desired environment and enabling adaptation to different moments.

This wireless home automation system allows you to remotely control multiple zones, unlimited receivers and perfect synchronization.

Receivers can be controlled by RF, WiFi (via APP) or voice (Amazon Alexa/Google Home).

(FR) EPLUS CONTROL c'est une gamme d'articles de contrôle sans fils de hautes performances, qui comprend des options pour contrôler l'éclairage mono LED, CCT, RGB, RGBW, RGBW+CCT et RGB DIGITAL.

Permettant la création des modes de couleurs, statiques ou alternés et dynamiques, offrant plusieurs options pour créer l'environnement souhaité et permettant l'adaptation aux différents moments.

Ce système automatisation résidentiel vous permet de contrôler plusieurs zones à distance, un nombre illimités des récepteurs et une synchronisation parfaite.

Les récepteurs peuvent être contrôlés par RF, WiFi (via APP) ou voix (Amazon Alexa/Google Home).



CONTROL

CONTROL

CONTROL



RECEIVER 001

107



1 CH, 8A/CH
96W (12VDC) / 192W (24VDC)
288W (36VDC)



RECEIVER 002

108

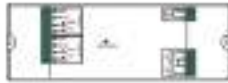

2CH (0-5/0-10/0-15VDC) 96w
20mA Max.



RECEIVER 003

109



4 CH, 5A/CH
240W (12VDC) / 480W (24VDC)
720W (36VDC)



RECEIVER 004

110



4 CH, 5A/CH
240W (12VDC) / 480W (24VDC)
720W (36VDC)



IP67

RECEIVER 005

111



5 CH, 5A/CH
300W (12VDC) / 600W (24VDC)
900W (36VDC)



RECEIVER 006

112



1 CH, 6.5A/CH
32.5W (5VDC) / 78W (12VDC)
Max. 2048 px / Min. 300 px



DRIVER 001

113



1 CH, 12VDC
50W/4.16A Max.



DRIVER 002

114



4 CH, 24VDC
75W/3.12A Max.



DRIVER 003

115



4 CH, 12VDC
100W/8.33A Max.
4 CH, 24VDC
100W/4.16A Max.



AMP 001

116



4 CH, 5A/CH
240W (12VDC) / 480W (24VDC)
720W (36VDC)



AMP 002

117



4 CH, 5A/CH
240W (12VDC) / 480W (24VDC)
720W (36VDC)



IP67

REMOTE A

118



4.5VDC
(3x AAA pilhas/ battery's/ piles)



REMOTE B

119



4.5VDC
(3x AAA pilhas/ battery's/ piles)



REMOTE C

120



4.5VDC
(3x AAA pilhas/ battery's/ piles)



REMOTE D

121



3VDC
(1x CR2025 pilha/ battery/ pile)

GATEWAY

122



12VDC
2.4GHz



SIMBOLOGIA

(ENG) SYMBOLOGY (FR) SYMBOLOGIE



PUSH-DIM

Regulação através de botão de pressão

(ENG) PUSH-DIM dimmer
(FR) Réglage par bouton poussoir



Função de Interruptor (Liga/Desliga)

(ENG) Switch Function (On/Off)
(FR) Fonction d'Interrupteur (Marche/Arrêt)



Dimável

(ENG) Dimable
(FR) Dimmable



Comunicam por Rádio Frequência

(ENG) Communicate by Radio Frequency
(FR) Communique par Radio Fréquence



Leds compatíveis

(ENG) Compatible Leds
(FR) Leds compatibles



Comandos de Voz compatíveis com Amazon Alexa e Google Home

(ENG) Amazon Alexa and Google Home Supported Voice Commands
(FR) Commandes vocales compatibles avec Amazon Alexa et Google Home



Artigos que trabalham por WiFi

(ENG) Work over WiFi
(FR) Articles qui fonctionnent par WiFi



Artigos que trabalham por μWiFi (micro-WiFi)

(ENG) Work by μWiFi (micro-WiFi)
(FR) Articles qui fonctionnent par μWiFi (micro-WiFi)



Compatível com sistema Android, IOS e Windows

(ENG) Compatible with Android, IOS and Windows system
(FR) Compatible avec le système Android, IOS et Windows



Aplicação Smart Life - Smart Living

(ENG) Smart Life - Smart Living Application
(FR) Application Smart Life - Smart Living



Aplicação wBox by blebox.eu

(ENG) wBox by blebox.eu Application
(FR) Application wBox by blebox.eu



Input



Base Magnética para Comando

(ENG) Magnetic base for Command
(FR) Base magnétique pour la télécommande



Suporte Magnético

(ENG) Magnetic support
(FR) Support magnétique



Entrada micro USB (5V)

(ENG) Micro USB Input (5V)
(FR) Entrée micro USB (5V)



CCT



RGB+W



RGB+CCT



RGB DIGITAL

IP54

Proteção contra poeiras e salpicos de água

(ENG) Protection against dust and water splash
(FR) Protection contre la poussière et les projections d'eau

IP67

À prova de poeiras e proteção contra imersão temporária em água

(ENG) Dust proof and protection against temporary immersion in water
(FR) Anti-poussière et protection contre l'immersion temporaire dans l'eau



Anos de Garantia

(ENG) Years Warranty
(FR) Années de Garantie



Certificado TUV

(ENG) RoHS compliant Certificate
(FR) Certificat RoHS compliant



Certificado UL

(ENG) RoHS compliant Certificate
(FR) Certificat RoHS compliant



Certificado RU

(ENG) RoHS compliant Certificate
(FR) Certificat RoHS compliant



Certificado FCC

(ENG) RoHS compliant Certificate
(FR) Certificat RoHS compliant



Certificado RoHS compliant

(ENG) RoHS compliant Certificate
(FR) Certificat RoHS compliant



Conformidade com as diretivas legais vigentes na Europa

(ENG) Compliance with legal directives in Europe
(FR) Conformité aux directives légales en vigueur en Europe



Impróprio ao lixo comum

(ENG) Inappropriate for common garbage
(FR) Inapproprié pour les ordures ménagères

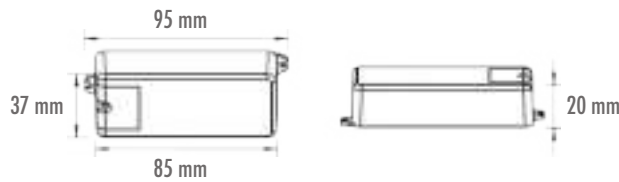
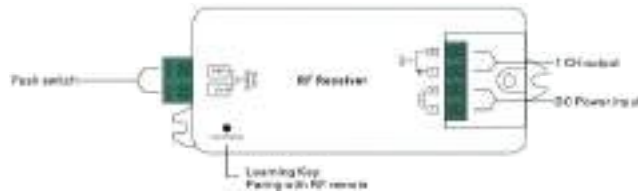

RECEIVER 001



RECEIVER 001 é um controlador que permite uma regulação de intensidade perfeita através de um botão de pressão ou comando remoto.

(ENG) RECEIVER 001 is a controller that allows perfect dimming via push-button or remote control.

(FR) Le RECEIVER 001 est un contrôleur qui permet une régulation parfaite, par un bouton-poussoir ou une commande à distance.

Referência Reference / Référence	Input	Output	Comando Remote control / Commande	PVP
ECT-RECEIVER001	12-36VDC	1 CH, 8A/CH 96W (12VDC) / 192W (24VDC) 288W (36VDC)	ECT-REMOTE-D	47,55 €

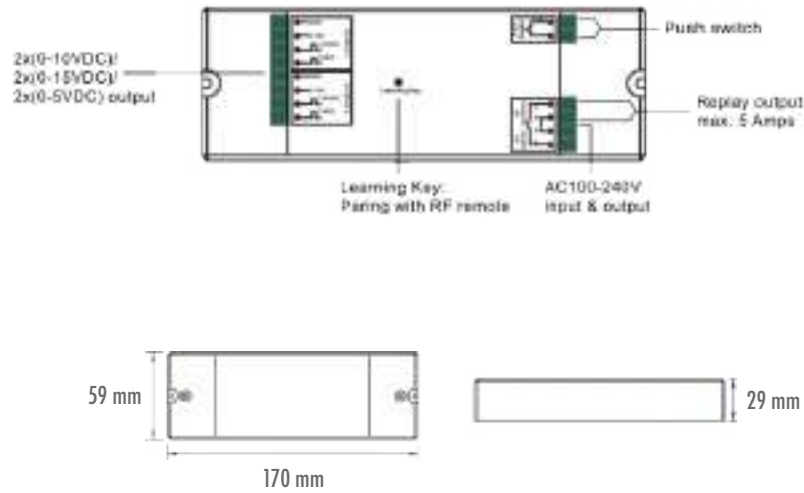

RECEIVER 002



RECEIVER 002 é um controlador concebido para gerir dispositivos que aceitem regulação 0-10V/PWM (Ex. Campânulas industriais).

(ENG) RECEIVER 002 is a controller designed to manage devices that accept 0-10V/PWM regulation (Ex. industrial bells).

(FR) RECEIVER 002 c'est un contrôleur conçu pour gérer les appareils qu'accepte une régulation 0-10V/PWM (Ex. cloches industrielles).

Referência Reference / Référence	Input	Output	Comando Remote control / Commande	PVP
ECT-RECEIVER002	100-240VAC 60mA Max.	2CH (0-5/0-10/0-15VDC) 96w 20mA Max.	ECT-REMOTE-D	105,96 €

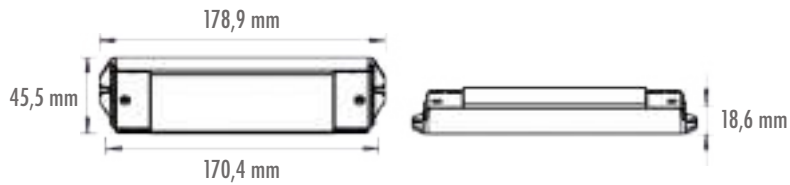
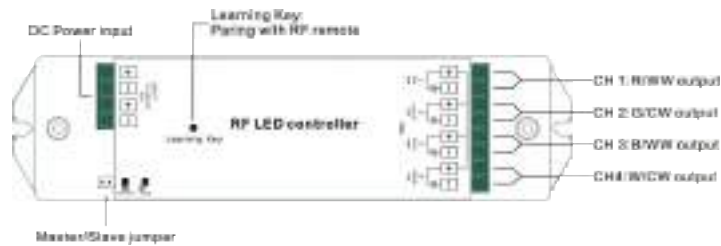

RECEIVER 003



Sinal RF
RF Signal
Signal RF

RECEIVER 003 é um controlador mono, CCT ou RGB+W. Com 4 canais de 5A pode controlar longos comprimentos de fita apenas com um comando ou via APP.

(ENG) RECEIVER 003 is a mono, CCT or RGB+W controller. With 4 channels of 5A you can control long lengths of Led tape with remote control or via APP.

(FR) Le RECEIVER c'est un contrôleur mono, CCT ou RGB+W. Avec 4 canaux de 5A, que permet de contrôler des longues longueurs de bande Led avec une commande à distance ou via APP.

Referência Reference / Référence	Input	Output	Comando Remote control / Commande	PVP
ECT-RECEIVER003	12-36 VDC	4 CH, 5A/CH 240W (12VDC) / 480W (24VDC) 720W (36VDC)	ECT-REMOTE-A ECT-REMOTE-B ECT-REMOTE-D	91,71 €

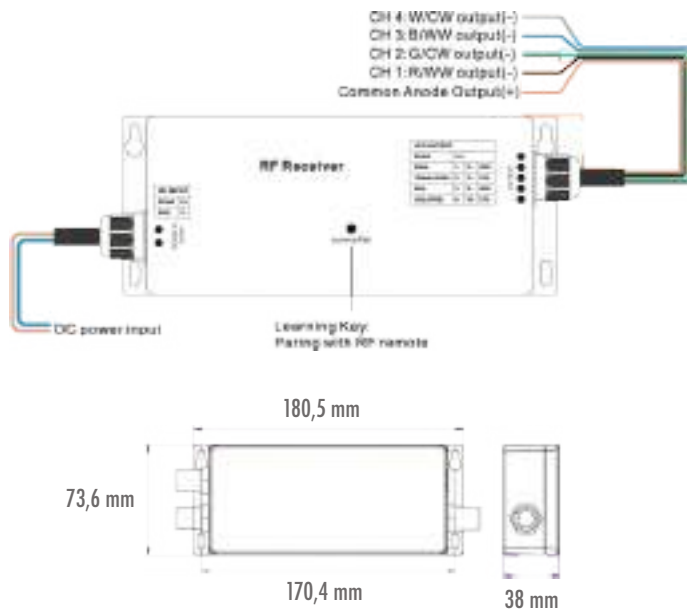

RECEIVER 004



RECEIVER 004 é um controlador mono, CCT ou RGB+W. Com IP67, pode ser instalado no exterior ou em zonas de humidade elevada.

(ENG) RECEIVER 004 is a mono, CCT or RGB+W controller. With IP67, it can be installed outdoors or in high humidity areas.

(FR) Le RECEIVER 004 c'est un contrôleur mono, CCT ou RGB+W. Avec IP67, il peut être installé à l'extérieur ou dans des zones très humides.

Referência Reference / Référence	Input	Output	Comando Remote control / Commande	PVP
ECT-RECEIVER004	12-36VDC	4 CH, 5A/CH 240W (12VDC) / 480W (24VDC) 720W (36VDC)	ECT-REMOTE-A ECT-REMOTE-B ECT-REMOTE-D	118,72 €

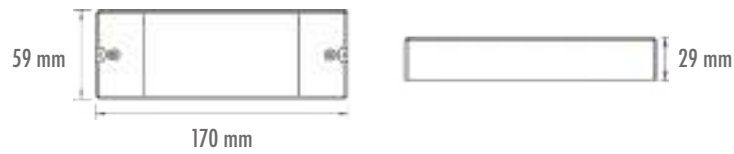
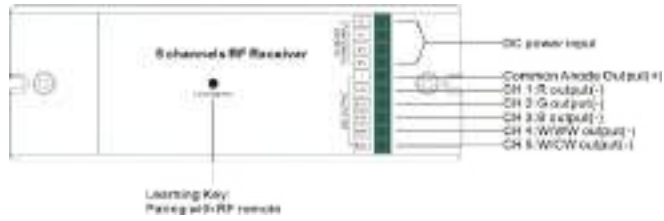

RECIIVER 005



RECIIVER 005 é controlador RF mais completo do mercado. Permite controlar todo o tipo de fitas LED com uma capacidade de 5A/CH.

(ENG) RECIIVER 005 is the most complete RF controller on the market. Allows you to control all types of LED tapes with a capacity of 5A/CH.

(FR) RECIIVER 005 est le contrôleur RF le plus complet du marché. Permet de contrôler tous types de bandes LED avec une capacité de 5A/CH.

Referência Reference / Référence	Input	Output	Comando Remote control / Commande	PVP
ECT-RECIIVER005	12-36 VDC	5CH, 5A/CH 300W (12VDC) / 600W (24VDC) 900W (36VDC)	ECT-REMOTE-A ECT-REMOTE-B ECT-REMOTE-C ECT-REMOTE-D	117,73 €

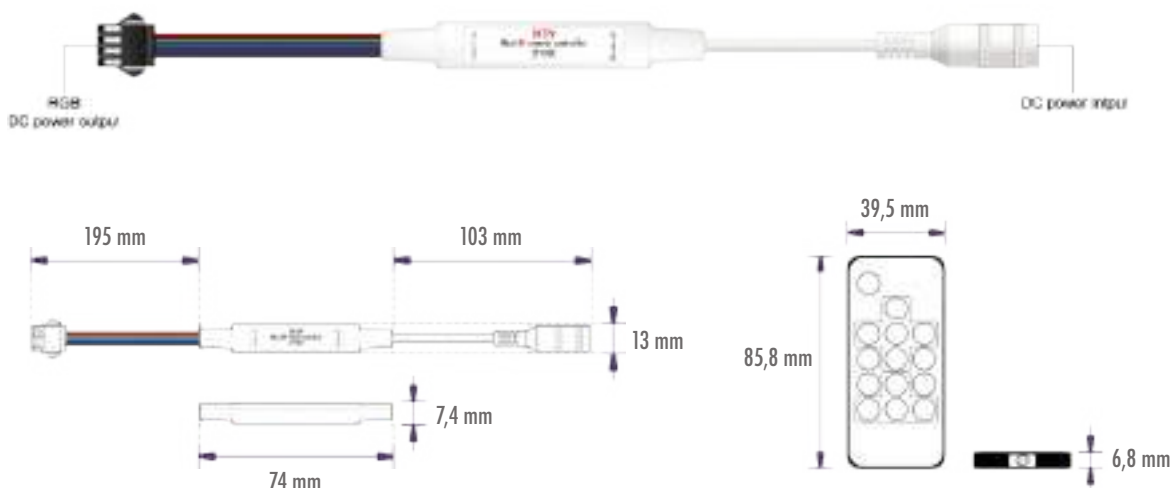

RECEIVER 006



Compatible Led
5050SMD
GS8208

Sinal RF
RF Signal
Signal RF

RECEIVER 006 é controlador RF para fita led endereçável. Simples e intuitivo.

(ENG) RECEIVER 006 is RF controller for addressable led strip (RGB DIGITAL). Simple and intuitive.
(FR) RECEIVER 006 est un contrôleur RF pour bande led adressable (RGB DIGITAL). Simple et intuitif.

Referência Reference / Référence	Input	Output	Comando Remote control / Commande	PVP
ECT-RECEIVER006	5-12 VDC	1 CH, 6.5A/CH 32.5W (5VDC) / 78W (12VDC) Max. 2048 px Min. 300 px	Incluido Included / Inclus	46,43 €

CONTROL

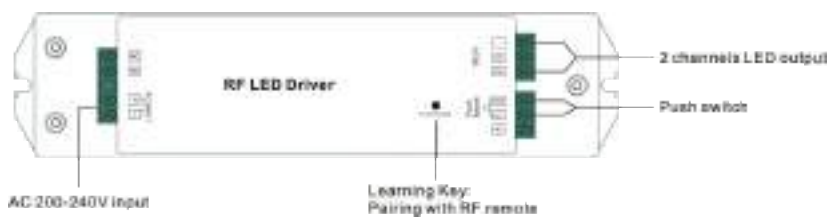

DRIVER 001



DRIVER 001 é um transformador e controlador de 50W. Controle 50W de fita com botão de pressão, comando à distância ou via APP.

(ENG) DRIVER 001 is a 50W transformer and controller. Control up to 50W of LED strip with push-button, remote control or via APP.

(FR) Le DRIVER 001 c'est un transformateur et contrôleur de 50W. Vous pouvez contrôler jusqu'à 50W de ruban LED avec bouton poussoir, commande à distance ou via APP.

Referência Reference / Référence	Input	Output	Comando Remote control / Commande	PVP
ECT-DRIVER001	200-240VAC	1 CH, 12VDC 50W/4.16A Max.	ECT-REMOTE-D	95,75 €

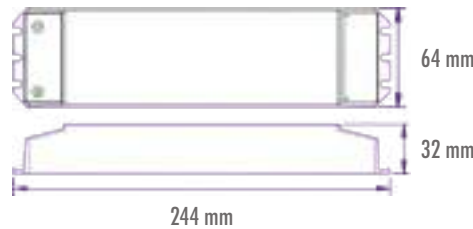
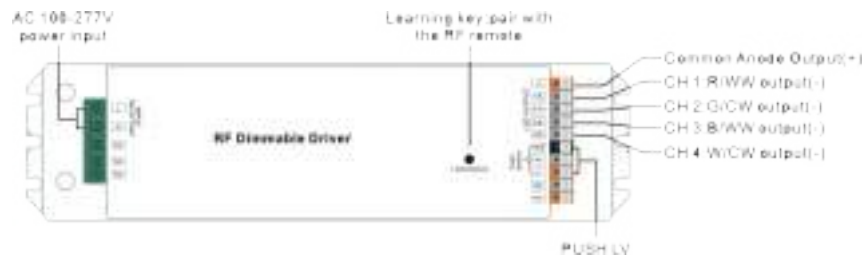

DRIVER 002



DRIVER 002 é um transformador e controlador de 75W. Controle 75W em modo mono, CCT ou RGBW com botão de pressão, comando à distância ou via APP.

(ENG) DRIVER 002 is a 75W transformer and controller. 75W control in mono, CCT or RGBW mode with push-button, remote command or via APP.

(FR) Le DRIVER 002 c'est un transformateur et contrôleur de 75W. Vous pouvez contrôler jusqu'à 75W en mode mono, CCT ou RGBW avec bouton poussoir, commande à distance ou via APP.

Referência Reference / Référence	Input	Output	Comando Remote control / Commande	PVP
ECT-DRIVER002	100-277VAC	4 CH, 24VDC 75W/3.12A Max.	ECT-REMOTE-A ECT-REMOTE-B ETC-REMOTE-D	114,17 €

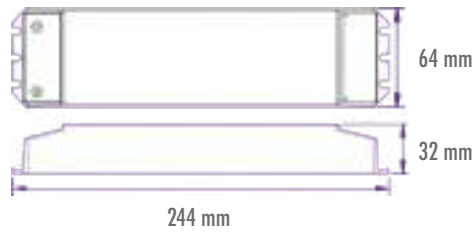
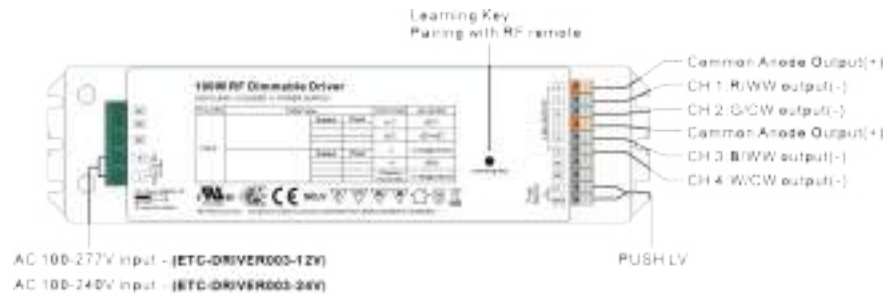

DRIVER 003



DRIVER 003 é um transformador e controlador de 100W. Controle 100W em modo mono, CCT ou RGBW com botão de pressão, comando á distância ou via APP.

(ENG) DRIVER 003 is a 100W transformer and controller. 100W control in mono, CCT or RGBW mode with push-button, remote command or via APP.

(FR) Le DRIVER 003 c'est un transformateur et contrôleur de 100W. Contrôle 100W en mode mono, CCT ou RGBW avec bouton poussoir, commande à distance ou via APP.

Referência Reference / Référence	Input	Output	Comando Remote control / Commande	PVP
ECT-DRIVER003-12V	100-277VAC	4 CH, 12VDC 100W/8.33A Max.	ECT-REMOTE-A ECT-REMOTE-B ETC-REMOTE-D	152,85 €
ECT-DRIVER003-24V	100-240VAC	4 CH, 24VDC 100W/4.16A Max.		

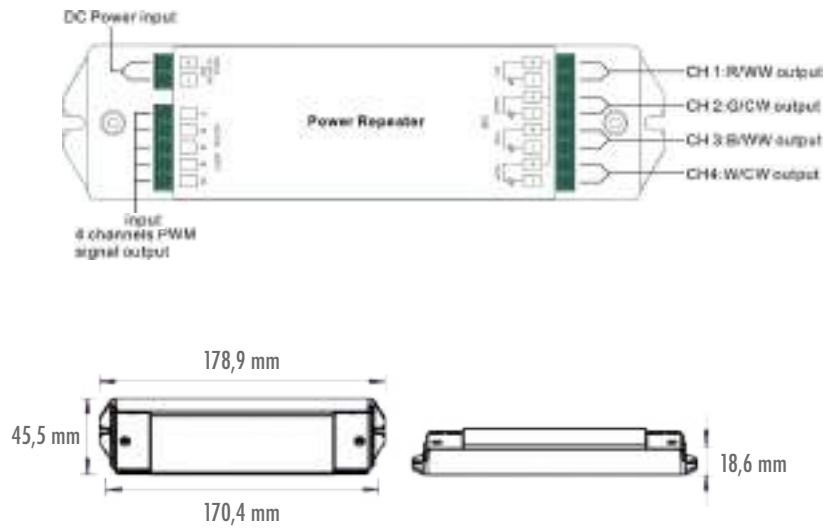

AMP 001



AMP 001 é um amplificador, compatível com todos os nossos controladores, que permite aumentar a potência da instalação.

(ENG) AMP 001 is an amplifier, compatible with all our controllers, which allows you to increase the power of the installation.

(FR) L'AMP 001 c'est un amplificateur, compatible avec tous nos contrôleurs, qui permet d'augmenter la puissance de l'installation.

Referência Reference / Référence	Input	Output	PVP
ECT-AMP001	12-36VDC	4 CH, 5A/CH 240W (12VDC) / 480W (24VDC) 720W (36VDC)	46,22 €

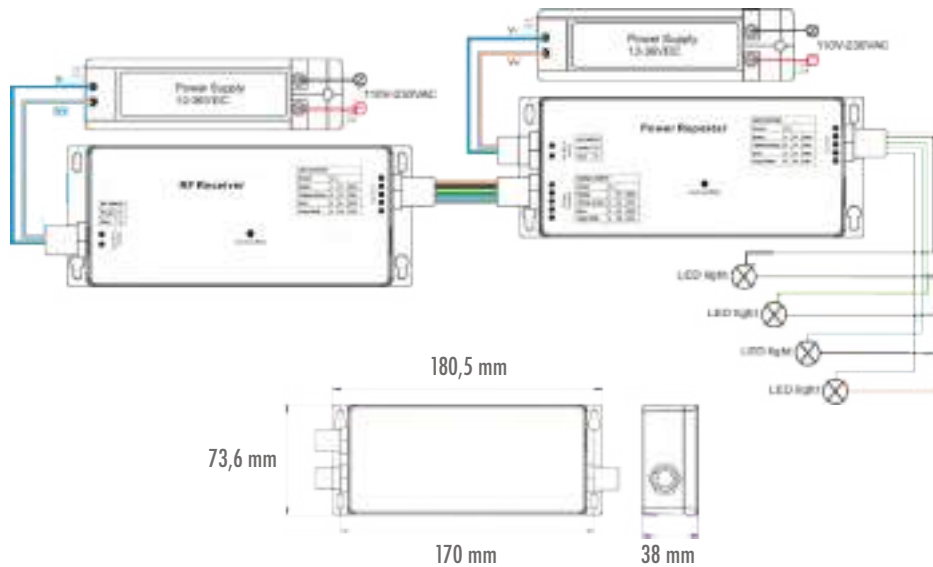

AMP 002



AMP 002 é um amplificador IP67, compatível com todos os nossos controladores, que permite aumentar a potência da instalação.

(ENG) AMP 002 is an IP67 amplifier, compatible with all our controllers, which allows you to increase the power of the installation.

(FR) L'AMP 002 c'est un amplificateur IP67, compatible avec tous nos contrôleurs, qui permet d'augmenter la puissance de l'installation.

Referência Reference / Référence	Input	Output	PVP
ECT-AMP002	12-36VDC	4 CH, 5A/CH 240W (12VDC) / 480W (24VDC) 720W (36VDC)	67,50 €

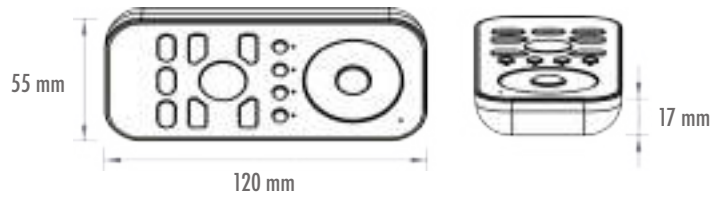

REMOTE A



Base Magnética
Magnetic Base
Base Magnétique

Sinal RF
RF Signal
Signal RF

REMOTE-A é um comando CCT que permite gerir 4 zonas distintas, associar um número ilimitado de controladores por zona e a gravação de cenários.

(ENG) REMOTE-A is an CCT command that allows managing 4 distinct zones, associating an unlimited number of controllers per zone and recording scenarios.

(FR) REMOTE-A c'est une commande à distance CCT qui permet de gérer 4 zones distinctes, associer un nombre illimité de contrôleurs par zone et l'enregistrement des scénarios.

Referência Reference / Référence	Voltagem de funcionamento Operating voltage/ Tension de fonctionnement	Frequência Frequency/ Fréquence	PVP
ECT-REMOTE-A	4.5VDC (3x AAA pilhas/ battery's/ piles)	434MHz/869.5MHz/ 9.16.5MHz	71,82 €

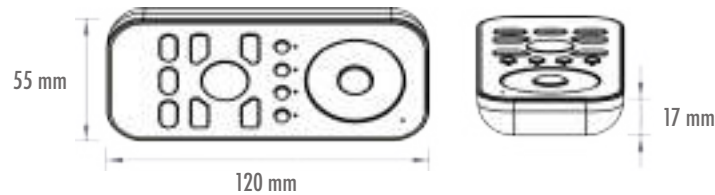

REMOTE B



Base Magnética
Magnetic Base
Base Magnétique

Sinal RF
RF Signal
Signal RF

REMOTE-B é um comando RGB que permite gerir 4 zonas distintas, associar um número ilimitado de controladores por zona e a gravação de cenários. Utilize os programas de reprodução dinâmicos para animar o seu ambiente.

(ENG) REMOTE-A is an RGB command that allows managing 4 distinct zones, associating an unlimited number of controllers per zone and recording scenarios. Use dynamic reproduction programs to liven up your environment.

(FR) REMOTE-A c'est une commande à distance RGB qui permet de gérer 4 zones distinctes, associer un nombre illimité de contrôleurs par zone et l'enregistrement des scénarios. Utilisez des programmes de reproduction dynamique pour animer votre environnement.

Referência Reference / Référence	Voltagem de funcionamento Operating voltage/ Tension de fonctionnement	Frequência Frequency/ Fréquence	PVP
ECT-REMOTE-B	4.5VDC (3x AAA pilhas/ battery's/ piles)	434MHz/869.5MHz/ 9.16.5MHz	71,82 €

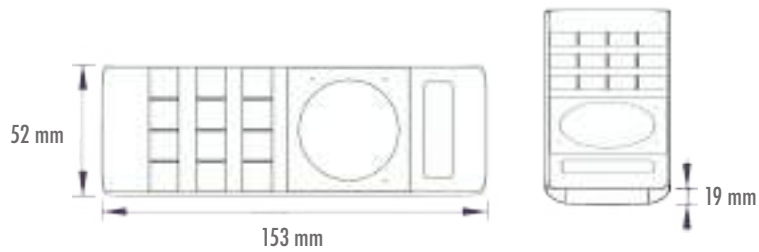

REMOTE C



Base Magnética
Magnetic Base
Base Magnétique



Sinal RF
RF Signal
Signal RF



REMOTE-C controla RGB e CCT em separado ou em conjunto. Permite programar, definir cenários e diferenciar zonas. Utilize os programas de reprodução dinâmicos para animar o seu ambiente.

(ENG) REMOTE-C controls RGB and CCT separately or together. Allows you to program, define scenarios and differentiate zones. Use dynamic reproduction programs to liven up your environment.

(FR) REMOTE-C contrôle RVB et CCT séparément ou ensemble. Permet de programmer, définir des scénarios et différencier des zones. Utilisez des programmes de reproduction dynamique pour animer votre environnement.

Referência Reference / Référence	Voltagem de funcionamento Operating voltage/ Tension de fonctionnement	Frequência Frequency/ Fréquence	PVP
ECT-REMOTE-C	4.5VDC (3x AAA pilha/ battery/ pile)	434MHz/869.5MHz/ 916.5MHz	102,76 €

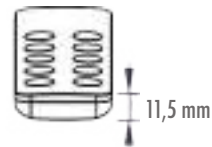
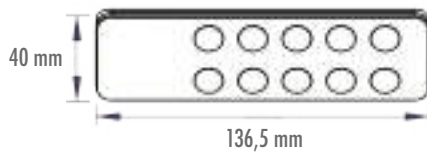

REMOTE D



Base Magnética
Magnetic Base
Base Magnétique



Sinal RF
RF Signal
Signal RF



REMOTE-D é um comando de regulação de intensidade que permite controlar 4 zonas e associar um número ilimitado de controladores.

(ENG) REMOTE-D is a dimming command that allows you to control 4 zones and associating an unlimited number of controllers per zone.

(FR) REMOTE-D c'est une commande à distance capable de régler l'intensité de la lumière, qui permet de contrôler 4 zones et associer un nombre illimité de contrôleurs par zone.

Referência Reference / Référence	Voltagem de funcionamento Operating voltage/ Tension de fonctionnement	Frequência Frequency/ Fréquence	PVP
ECT-REMOTE-D	3VDC (1x CR2025 pilha/ battery/ pile)	434MHz/869.5MHz/ 9.16.5MHz	27,99 €

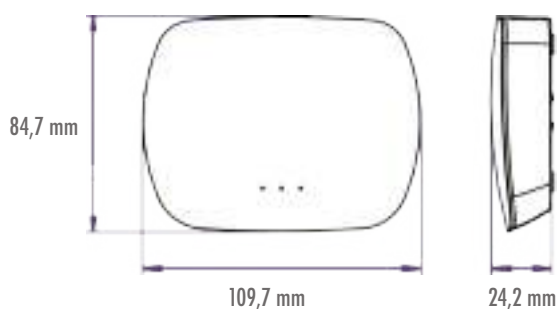

GATEWAY



O GATEWAY serve para gerir os seus controladores via APP através do WiFi
 (ENG) The GATEWAY is for managing your controllers via APP, connected from WiFi.
 (FR) Le GATEWAY permet de gérer vos contrôleurs via APP, connectés depuis le WiFi.

Referência Reference / Référence	Voltagem de funcionamento Operating voltage/ Tension de fonctionnement	Frequência Frequency/ Fréquence	PVP
ECT-GATEWAY	12VDC	2.4 GHz	125,58 €



e⁺ CONTROL





IP54

WLIGHT BOX

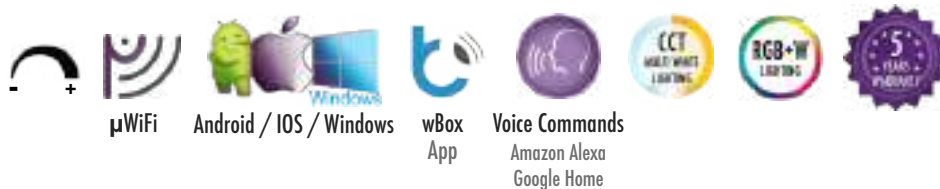

µWiFi

Android / IOS / Windows

wBox
App

Voice Commands
Amazon Alexa
Google Home

WLightBox é o controlador de luz sem fios mais pequeno do mundo, que lhe permite controlar a iluminação LED monocromática, RGBW e CCT. Também disponível em versão PRO com IP54.

(ENG) WLightBox is the world's smallest wireless light controller, that lets you control monochrome, RGBW and CCT LED lighting. Also available in PRO version with IP54.

(FR) WLightBox est le plus petit contrôleur d'éclairage sans fil au monde, qui vous permet de contrôler l'éclairage LED monocromatique, RGBW et CCT. Également disponible en version PRO avec IP54.

Referência Reference / Référence	Input	Output	PVP
WLIGHTBOXIP20	12-24VDC	4 CH, 3A/CH 144W (12VDC) / 288W (24VDC)	67,21 €
WLIGHTBOXPROIP54			96,36 €



IP54

WLIGHT BOX S



WLightBox S é um dispositivo em miniatura que lhe permite controlar o brilho da iluminação LED de cor única através da APP.
Também disponível em versão PRO com IP54.

(ENG) WLightBox S is a miniature device that allows you to control the brightness of single color LED lighting through the APP. Also available in PRO version with IP54.
(FR) WLightBox S est un appareil miniature qui vous permet de contrôler la luminosité de l'éclairage LED monocolore via l'APP. Également disponible en version PRO avec IP54.

Referência Reference / Référence	Input	Output	PVP
WLIGHTBOXSIP20	12-24VDC	1CH, 5A 60W (12VDC) / 120W (24VDC)	49,30 €
WLIGHTBOXPROIP54			87,39 €



WLIGHT BOX 5



WLightBox 5 é controlador RGB CCT mais pequeno do mundo. Controla e programa todas as cores com apenas um dispositivo.

(ENG) WLightBox 5 is the smallest RGB+CCT controller in the world. Control and program all colors with just one device.

(FR) WLightBox 5 est le plus petit contrôleur RGB+CCT au monde. Contrôlez et programmez toutes les couleurs avec un seul appareil.

Referência Reference / Référence	Input	Output	PVP
WLIGHTBOX5IP20	12-24VDC	5 CH, 3A/CH 180W (12VDC) / 360W (24VDC)	POR CONSULTA UNDER REQUEST SUR DEMANDE



PIXEL BOX



PixelBox é um controlador dedicado a sistemas RGB digital LED de 5V e 12V. Crie efeitos e controle até 360 diodos em qualquer parte do mundo.

(ENG) PixelBox is a controller dedicated to 5V and 12V LED digital RGB systems. Create effects and control up to 360 diodes from anywhere in the world.

(FR) PixelBox est un contrôleur dédié aux systèmes LED RGB DIGITAL 5V et 12V. Créez des effets et contrôlez jusqu'à 360 diodes depuis n'importe où dans le monde.

Referência Reference / Référence	Input	Output	Leds compatíveis Compatible leds / Leds compatibles	PVP
PIXELBOXIP20	12-24VDC	1CH, 5A 25W (5VDC) / 60W (12VDC)	ws2815 rgb ws2811 rgb LC8088 rgb WS2812 WS2811	67,28 €



AMP BOX

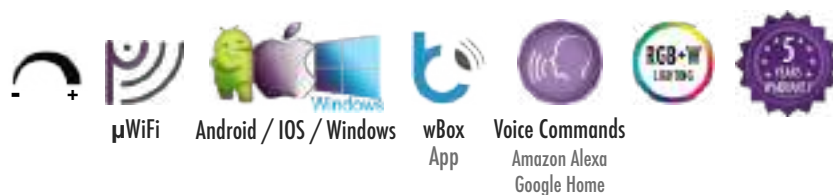

AmpBox é um amplificador LED profissional de quatro canais, concebido para funcionar em sistemas LED tradicionais e inteligentes de baixa voltagem.

(ENG) AmpBox is a professional four-channel LED amplifier, designed to work in traditional and intelligent low-voltage LED systems.

(FR) AmpBox est un amplificateur LED professionnel à quatre canaux, conçu pour fonctionner dans les systèmes LED traditionnels et intelligents de basse tension.

Referência Reference / Référence	Input	Output	PVP
AMPBOXIP20	12-24VDC	4CH, 5A/CH 240W (12VDC) / 480W (24VDC)	40,33 €



SWITCH BOX

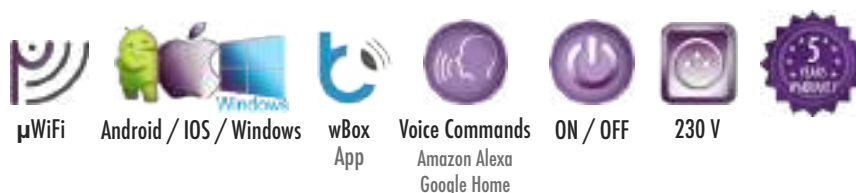

SwitchBox é o controlador mais pequeno do mundo, que permite, sem fios e de qualquer lugar, ligar e desligar aparelhos alimentados a 230V com potência até 1kW. Disponível em versão de 1 ou 2 canais (CH).

(ENG) SwitchBox is the smallest controller in the world, which allows, wirelessly and from anywhere, to turn on and off devices powered at 230V with power up to 1kW. Available in 1 or 2 channel (CH) version.

(FR) SwitchBox est le plus petit contrôleur au monde, qui permet, sans fils et de n'importe où, d'allumer et d'éteindre des appareils alimentés en 230V, avec une puissance jusqu'à 1kW. Disponible en version de 1 ou 2 canaux (CH).

Referência Reference / Référence	Input	Output	PVP
SWITCHBOXP20		1CH, 16A	89,64 €
SWITCHBOXLIGHTIP20	230V AC	1CH, 5A	65,59 €
SWITCHBOXDIP20		2CH, 5A	89,64 €



DIMMER BOX

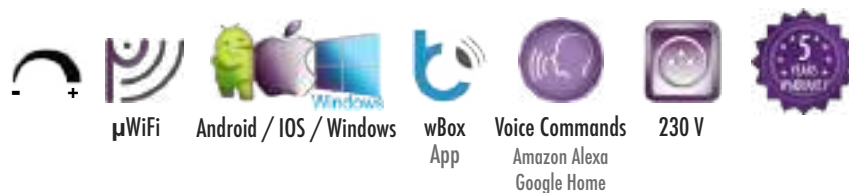

DimmerBox permite controlar a intensidade luminosa da divisão e criar diferentes atmosferas através do telemóvel.

(ENG) DimmerBox lets you control the light intensity of the room and create different atmospheres via your mobile phone.

(FR) DimmerBox vous permet de contrôler l'intensité lumineuse de la pièce et de créer différentes ambiances à partir de votre téléphone portable.

Referência Reference / Référence	Input	Output	PVP
DIMMERBOXV2IP20	230V AC	1CH, 1A	89,64 €



ACTION BOX S

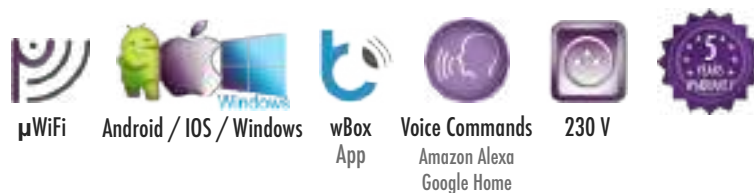

A central de controlo mais pequena do mundo. ActionBox S permite controlar os outros dispositivos de forma autónoma, recebendo informação de outros sensores, executando acções e notificando o utilizador do que se passa.

(ENG) The smallest control center in the world. ActionBox S lets you control other devices autonomously, receiving information from other sensors, executing actions and notifying the user of what is happening.

(FR) Le plus petit centre de contrôle au monde. ActionBox S vous permet de contrôler d'autres appareils de manière autonome, de recevoir des informations d'autres capteurs, d'exécuter des actions et d'informer l'utilisateur de ce qui se passe.

Referência Reference / Référence	Input	Output	PVP
ACTIONBOXSIP20	230V AC	1CH, 1A	59,80 €



PROXI BOX



Controle outros dispositivos através de toque mas de forma invisível. O ProxiBox pode ser instalado atrás de uma superfície.
Calibração automática mediante a espessura e tipo de material.

(ENG) Control other devices by touch but invisibly. ProxiBox can be installed behind a surface. Automatic calibration depending on the thickness and type of material.

(FR) Contrôlez d'autres appareils au toucher mais de manière invisible. ProxiBox peut être installé derrière une surface.
 Calibrage automatique en fonction de l'épaisseur et du type de matériau.

Referência Reference / Référence	Input	PVP
PROXIBOXIP20	12-24VDC	67,21 €



PROXI DIMMER



Regulador de intensidade oculto. Calibração automática mediante a espessura e tipo de material.

(ENG) PixelBox is a controller dedicated to 5V and 12V LED digital RGB systems. Create effects and control up to 360 diodes from anywhere in the world.

(FR) PixelBox est un contrôleur dédié aux systèmes LED RGB DIGITAL 5V et 12V. Créez des effets et contrôlez jusqu'à 360 diodes depuis n'importe où dans le monde.

Referência Reference / Référence	Input	Output	PVP
PROXIDIMMERIP20	12-24VDC	1CH, 5A 60W (12VDC) / 120W (24VDC)	35,85 €



PROXI SWITCH



ProxiSwitch é um interruptor oculto que pode ser instalado atrás de diversas superfícies. Calibração automática mediante a espessura e tipo de material.

(ENG) ProxiSwitch is a hidden switch that can be installed behind many surfaces. Automatic calibration based on the thickness and type of material.

(FR) ProxiSwitch est un interrupteur caché qui peut être installé derrière de nombreuses surfaces. Calibrage automatique en fonction de l'épaisseur et du type de matériau.

Referência Reference / Référence	Input	Output	PVP
PROXISWITCHIP20	12-24VDC	1CH, 5A 60W (12VDC) / 120W (24VDC)	35,85 €



U REMOTE

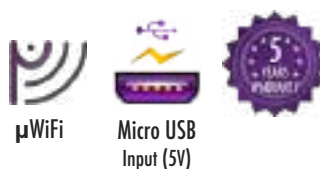

Comando remoto programável e recarregável (micro USB). Corpo metálico e resistente. Tem 3 canais diferentes nos quais pode programar 3 botões diferentes.
 (ENG) Programmable and rechargeable remote control (micro USB). Metallic and resistant body. It has 3 different channels on which you can program 3 different buttons.
 (FR) Télécommande programmable et rechargeable (micro USB). Corps métallique et résistant. Il dispose de 3 canaux différents sur lesquels vous pouvez programmer 3 boutons différents.

BLEBOX

Referência Reference / Référence	Tensão de alimentação Supply voltage / Tension d'alimentation	Frequência Frequency / Fréquence	PVP
UREMOTE	Bateria de polímero de lítio Lithium-polymer battery Batterie lithium-polymère	2.4 GHz	76,18 €



U REMOTE



Comando de 4 teclas programáveis. Utilize a App para configurar as funções de cada tecla. Funcional e simples.

(ENG) Command of 4 programmable keys. Use the App to configure the functions of each key. Functional and simple.

(FR) Commande de 4 touches programmables. Utilisez l'application pour configurer les fonctions de chaque touche. Fonctionnel et simple.

Referência Reference / Référence	Tensão de alimentação Supply voltage / Tension d'alimentation	Frequência Frequency / Fréquence	PVP
SREMOTE	X2 pilhas alcalinas LR03 / AAA 2x alkaline battery 2 piles alcalines	2.4 GHz	65 €

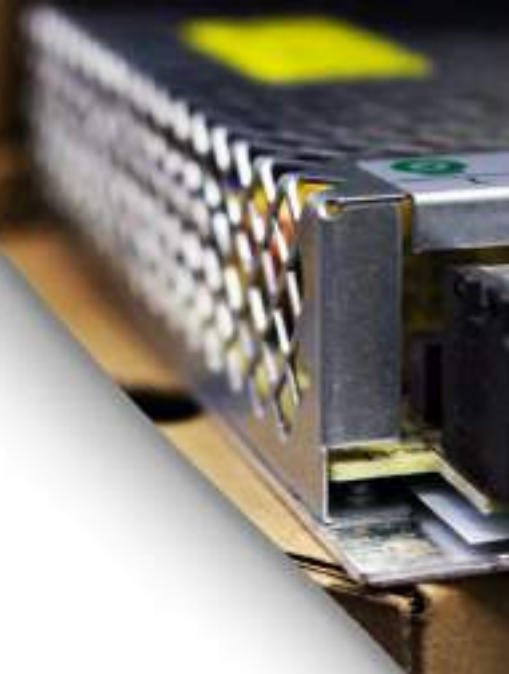

e⁺ POWER

EPLUS POWER é uma seleção dos melhores transformadores para instalações de tensões reduzidas. Uma gama completa, com soluções de características únicas que respondem a todas as necessidades do mercado de tensão constante.

(ENG) EPLUS POWER is a selection of the best transformers for low voltage installations.

A complete range, with unique feature solutions that meet all the needs of the constant voltage market.

(FR) EPLUS POWER est une sélection des meilleurs transformateurs pour les installations à basse tension. Une gamme complète, avec des solutions aux fonctionnalités uniques qui répondent à tous les besoins du marché à tension constante.





POS C 2

POWER

141



5V/12V/24V

35W | 50W | 75W | 100W | 150W | 200W | 350W

DIN

142



12V/24V

15W | 30W | 60W | 100W |

FTPC S

143



12V/24V

30W | 60W | 100W | 150W | 200W | 240W

FTPC S WP

144



12V/24V

60W | 100W | 150W

IP66

FTPC DA

145



12V/24V

60W | 100W | 150W

IP30



PUSH-DIM

FTPC DA WP

146



12V/24V

60W | 100W | 150W

IP67



PUSH-DIM

FTPC FP

147



12V/24V

6W | 12W | 15W | 20W | 30W | 60W | 100W

IP44

GPV

148



5V/12V/15V/24V/36V

12W | 18W | 35W | 50W | 60W | 75W | 100W | 120W | 150W | 200W

IP67

GLSV

149



12V/24V/36V/48V

35W | 50W | 75W | 100W | 150W | 200W | 320W

IP67



GTPC S

150



12V/24V

30W | 45W | 60W | 75W | 100W | 150W | 200W | 240W

GTPC D

151



12V/24V

25W | 50W | 100W



TRIAC

MPL 03

152



350mA/700mA

3W

IP65

MPLC 12/16

153



350mA/700mA

12W | 16W

MPL 06

154



12V/24V

6W

MPL 12

155



12V

12W

MPL 16 LC

156



12V/24V

15W

POWER

SIMBOLOGIA (ENG) SYMBOLOGY (FR) SYMBOLOGIE



Regulação Triac
(ENG) Triac regulation
(FR) Régulation Triac

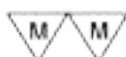

Conformidade com o regulamento Europeu, para montagem dentro de caixas inflamáveis
(ENG) Compliance with European regulations, for mounting inside flammable boxes
(FR) Conformité à la réglementation Européenne, pour montage à l'intérieur de boîtes inflammables



Instalação em superfícies facilmente inflamáveis
(ENG) Installation on easily flammable surfaces
(FR) Installation sur des surfaces facilement inflammables



Em caso de sobrecarga ou curto-circuito, a temperatura superficial do transformador não excede os 110°C
(ENG) In case of overload or short circuit, the surface temperature of the transformer does not exceed 110°C
(FR) En cas de surcharge ou de court-circuit, la température de surface du transformateur ne dépasse pas 110°C



Símbolo Internacional de proteção Classe II
(ENG) International Class II Protection Symbol
(FR) Symbole International de protection de Classe II



Transformador primário com isolamento de segurança e proteção contra curto-circuito
(ENG) Primary transformer with safety isolation and short circuit protection
(FR) Transformateur primaire avec isolation de sécurité et protection contre les courts-circuits



Símbolo Internacional para conversor independente
(ENG) International symbol for standalone converter
(FR) Symbole international pour convertisseur indépendant



Proteção eléctrica Classe II
(ENG) Second class of electrical protection
(FR) Protection électrique Classe II



Certificado de Segurança NEMKO
(ENG) NEMKO Security Certificate
(FR) Certificat de sécurité NEMKO



Certificado EMC pela NEMKO - EN 55015, EN 62493, EN 61547
(ENG) EMC Certified by NEMKO - EN 55015, EN 62493, EN 61547
(FR) EMC Certifié par NEMKO - EN 55015, EN 62493, EN 61547



Certificado EMC - EN 55015, EN 62493, EN 61547
(ENG) EMC Certified - EN 55015, EN 62493, EN 61547
(FR) Certifié EMC - EN 55015, EN 62493, EN 61547



Certificado SEMKO
(ENG) SEMKO Certified
(FR) Certifié SEMKO



Aplicação no interior
(ENG) Indoor application
(FR) Application en intérieur



PUSH-DIM

Regulação através de botão de pressão
(ENG) PUSH-DIM dimmer
(FR) Réglage par bouton poussoir

IP30

Proteção contra objetos sólidos com 2,5 mm de diâmetro ou mais
(ENG) Protection against solid objects 2.5 mm in diameter or larger
(FR) Protection contre les objets solides de 2,5 mm de diamètre ou plus

IP44

Proteção contra objetos sólidos com 1,0 mm de diâmetro ou mais e salpicos de água
(ENG) Protection against solid objects 1.0 mm in diameter or larger and splashing water
(FR) Protection contre les objets solides de 1,0 mm de diamètre ou plus et les projections d'eau

IP66

À prova de poeira e proteção contra massas em água
(ENG) Dust proof and protection against masses in water
(FR) Anti-poussière et protection contre les masses dans l'eau

IP67

À prova de poeiras e proteção contra imersão temporária em água
(ENG) Dust proof and protection against temporary immersion in water
(FR) Anti-poussière et protection contre l'immersion temporaire dans l'eau



Anos de Garantia
(ENG) Years Warranty
(FR) Années de Garantie



Regulação DALI2
(ENG) Régulation DALI2
(FR) Régulation DALI2



Certificado TUV
(ENG) RoHS compliant Certificate
(FR) Certificat RoHS compliant



Certificado TUV Rheinland
(ENG) TUV Rheinland Certificate
(FR) Certificat TUV Rheinland



Certificado RoHS compliant
(ENG) RoHS compliant Certificate
(FR) Certificat RoHS compliant

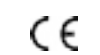

Conformidade com as diretivas legais vigentes na Europa
(ENG) Compliance with legal directives in Europe
(FR) Conformité aux directives légales en vigueur en Europe



Impróprio ao lixo comum
(ENG) Inappropriate for common garbage
(FR) Inapproprié pour les ordures ménagères

SELV

Safety Extra-Low Voltage

LPS

Limited Power Source - IEC 60950-1

POWER



POS C2



- **Tensão Constante.**
(ENG) Constant Voltage Design.
(FR) Conçu pour Tension constant.
- **Tensão de Entrada universal**
(ENG) Universal AC Input Range.
(FR) Plage d'Entrée AC universelle.
- **Proteção contra Sobreaquecimento/Curto-circuito/Sobretensão.**
(ENG) Overheat Protection/Short-circuit/Over voltage.
(FR) Protection contre la Surchauffe//Court-circuit/Surtension.
- **Arrefecimento por livre circulação de ar (excepto POS-350-C).**
(ENG) Cooling by free air convection (except POS-350-C).
(FR) Refroidissement avec circulation d'air libre (sauf POS-350-C).
- **Baixo perfil - 30 mm de altura.**
(ENG) Low profile - 30 mm high.
(FR) Profil bas - 30 mm de haut.

Referência Reference / Référence	Output	Potência Power / Puissance	Dimensões (mm) Dimensions	PVP
POS-35-5-C2	5V/ 7A	35W	99 x 82 x 30	18,88 €
POS-35-12-C2	12V/ 3A			
POS-35-24-C2	24V/ 1.5A	36W		
POS-50-5-C2	5V/ 10A	50W	99 x 82 x 30	20,93 €
POS-50-12-C2	12V/ 4.2A			
POS-50-24-C2	24V/ 2.1A	50.4W		
POS-75-12-C2	12V/ 6A	72W	99 x 97 x 30	24,60 €
POS-75-24-C2	24V/ 3.2A	77W		
POS-100-5-C2	5V/ 16A	80W	129 x 97 x 30	26,17 €
POS-100-12-C2	12V/ 8.4A	101W		
POS-100-24-C2	24V/ 4.2A			
POS-150-5-C	5V/ 22A	110W	159 x 97 x 30	33,42 €
POS-150-12-C2	12V/ 12.5A			
POS-150-24-C2	24V/ 6.25A	150W		
POS-200-12-C2	12V/ 16.7A	200W	215 x 115 x 30	46,16 €
POS-200-24-C2	24V/ 8.3A	199W		
POS-350-5-C	5V/ 60A	300W	215 x 115 x 30	56,44 €
POS-350-12-C2	12V/ 29.2A			
POS-350-24-C2	24V/ 14.6A	350,4W		





DIN

- **Tensão Constante.**
(ENG) Constant Voltage Design.
(FR) Conçu pour Tension constant.
- **Tensão de Entrada Europeia**
(ENG) EU AC Input Range.
(FR) Plage d'Entrée AC Européenne.
- **Possibilidade de instalação em calha TS-35 / DIN.**
(ENG) Can be installed on TS-35 / DIN rail.
(FR) Peut être installé sur rail TS-35 / DIN.
- **Excelente relação qualidade - preço.**
(ENG) Excellent quality / price ratio.
(FR) Excellent rapport qualité/prix.

Referência Reference / Référence	Output	Potência Power / Puissance	Dimensões (mm) Dimensions	PVP
DIN15W12 DIN15W24	12V/ 1.25A 24V/ 0.63A	15W	25 x 92,5 x 56	14,62 €
DIN30W12 DIN30W24	12V/ 2.5A 24V/ 1.25A	30W	65,5 x 93 x 56	22,43 €
DIN60W12 DIN60W24	12V/ 6A 24V/ 3.2A	60W	78 x 93 x 56	30,46 €
DIN100W12 DIN100W24	12V/ 8.3A 24V/ 4.15A	100W	100 x 93 x 56	36,29 €





FTPC S



- **Conformidade com os parâmetros de segurança mundiais para iluminação.**
(ENG) Compliance to worldwide regulations for lighting.
(FR) Conformité aux normes internationales d'éclairage.
- **Filtro ativo de fator de correção de potência (PFC).**
(ENG) Built-In active PFC function.
(FR) Fonction PFC active intégrée.
- **Arrefecimento por livre circulação de Ar.**
(ENG) Cooling by free Air convection.
(FR) Refroidissement avec circulation d'air libre.
- **Encapsulamento fino e estreito.**
(ENG) Narrow and low profile.
(FR) Boîte étroite et basse.
- **Aprovadas e certificadas para iluminação direta na madeira.**
(ENG) Approved for for installation directly in Wood.
(FR) Homologué et certifié pour l'éclairage direct sur bois.
- **EN 61347 - 2 - 13**

Referência Reference / Référence	Output	Potência Power / Puissance	Dimensões (mm) Dimensions	PVP
FTPC30V12-S FTPC30V24-S	12V/ 2.5A 24V/ 1.25A	30W	251 x 30 x 16	28,78 €
FTPC60V12-S FTPC60V24-S	12V/ 5A 24V/ 2.5A	60W	304,5 x 30 x 17	49,44 €
FTPC100V12-S FTPC100V24-S	12V/ 8.33A 24V/ 4.17A	100W	321 x 30 x 18,5	73,63 €
FTPC150V12-S FTPC150V24-S	12V/ 11A 24V/ 6.25A	132W 150W	323 x 30 x 22	87,63 €
FTPC200V12-S FTPC200V24-S	12V/ 15A 24V/ 8.33A	180W 200W	356,4 x 32,1 x 22,3	109,76 €
FTPC240V24-S	24V/ 10A	240W	356,4 x 32,1 x 22,3	120,61 €

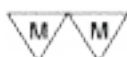

SELV



FTPC S WP

- **Conformidade com os parâmetros de segurança mundiais para iluminação.**
(ENG) Compliance to worldwide regulations for lighting.
(FR) Conformité aux normes internationales d'éclairage.
- **Filtro ativo de fator de correção de potência (PFC).**
(ENG) Built-In active PFC function.
(FR) Fonction PFC active intégrée.
- **Arrefecimento por livre circulação de Ar.**
(ENG) Cooling by free Air convection.
(FR) Refroidissement avec circulation d'air libre.
- **Encapsulamento fino e estreito.**
(ENG) Narrow and low profile.
(FR) Boîte étroite et basse.
- **Aprovadas e certificadas para iluminação direta na madeira.**
(ENG) Approved for for installation directly in Wood.
(FR) Homologué et certifié pour l'éclairage direct sur bois.
- **EN 61347 - 2 - 13**

Referência Reference / Référence	Output	Potência Power / Puissance	Dimensões (mm) Dimensions	PVP
FTPC60V12-S-WP FTPC60V24-S-WP	12V/ 5A 24V/ 2.5A	60W	339 x 30 x 18	55,32 €
FTPC100V12-S-WP FTPC100V24-S-WP	12V/ 8.33A 24V/ 4.17A	100W	359 x 30 x 20	75,13 €
FTPC150V12-S-WP FTPC150V24-S-WP	12V/ 11A 24V/ 6.25A	132W 150W	359 x 30 x 23	100,43 €



IP66

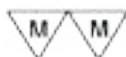

SELV



FTPC DA



- **Amplitude da Tensão de Entrada : 180 - 264 VAC.**
(ENG) Input Voltage Range : 180 - 264 VAC.
(FR) Plage de Tension d'Entrée : 180 - 264 VAC.
- **Arrefecimento por livre circulação de ar.**
(ENG) Cooling by free air convection.
(FR) Refroidissement avec circulation d'air libre.
- **Proteção contra Sobreaquecimento.**
(ENG) Overheat Protection.
(FR) Protection contre la Surchauffe.
- **DALI 2 IEC62386**

Referência Reference / Référence	Output	Potência Power / Puissance	Dimensões (mm) Dimensions	PVP
FTPC60V12-DA FTPC60V24-DA	12V/ 5A 24V/ 2.5A	60W	361,5 x 30 x 21,3	82,56 €
FTPC100V12-DA FTPC100V24-DA	12V/ 8.33A 24V/ 4.17A	100W	361,5 x 30 x 21,3	112,31 €
FTPC150V12-DA FTPC150V24-DA	12V/ 11A 24V/ 6.25A	132W 150W	361,5 x 30 x 21,3	135,49 €



IP30

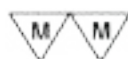

SELV



FTPC DA WP

- **Amplitude da Tensão de Entrada : 180 - 264 VAC.**
(ENG) Input Voltage Range : 180 - 264 VAC.
(FR) Plage de Tension d'Entrée : 180 - 264 VAC.
- **Proteção contra Sobreaquecimento.**
(ENG) Overheat Protection.
(FR) Protection contre la Surchauffe.
- **Arrefecimento por livre circulação de ar.**
(ENG) Cooling by free air convection.
(FR) Refroidissement avec circulation d'air libre.
- **DALI 2 IEC62386**

Referência Reference / Référence	Output	Potência Power / Puissance	Dimensões (mm) Dimensions	PVP
FTPC60V12-DA-WP FTPC60V24-DA-WP	12V/ 5A 24V/ 2.5A	60W	407,6 x 37 x 21,4	97,18 €
FTPC100V12-DA-WP FTPC100V24-DA-WP	12V/ 8.33A 24V/ 4.17A	100W	407,6 x 37 x 21,4	113,74 €
FTPC150V12-DA-WP FTPC150V24-DA-WP	12V/ 11A 24V/ 6.25A	132W 150W	407,6 x 37 x 21,4	148,06 €

POS





FTPC FP



- **Conformidade com os parâmetros de segurança mundiais para iluminação.**
(ENG) Compliance to worldwide regulations for lighting.
(FR) Conformité aux normes internationales d'éclairage.
- **Aprovadas e certificadas para instalação direta na madeira.**
(ENG) Approved for for installation directly in Wood.
(FR) Homologué et certifié pour l'éclairage direct sur bois.
- **Conformidade com a Directiva ERP.**
(ENG) Compliance to ERP Directive.
(FR) Conformité à la Directive ERP.
- **Arrefecimento por livre circulação de ar.**
(ENG) Cooling by free air convection.
(FR) Refroidissement avec circulation d'air libre.
- **Isolamento de classe II.**
(ENG) Class II insulation.
(FR) Isolation Classe II.
- **EN 55015, EN61347-2-13.**

Referência Reference / Référence	Output	Potência Power / Puissance	Dimensões (mm) Dimensions	PVP
FTPC6V12-FP FTPC6V24-FP	12V/ 0.5A 24V/ 0.25A	6W	132 x 52 x 12	12,97 €
FTPC12V12-FP FTPC12V24-FP	12V/ 1A 24V/ 0.5A	12W	132 x 52 x 12	16,84 €
FTPC15V12-FP FTPC15V24-FP	12V/ 1.25A 24V/ 0.625A	15W	130 x 41,5 x 15	18,19 €
FTPC20V12-FP FTPC20V24-FP	12V/ 1.67A 24V/ 0.83A	20W	127 x 44 x 14,5	20,56 €
FTPC30V12-FP FTPC30V24-FP	12V/ 2.5A 24V/ 1.25A	30W	158 x 51 x 17,3	31,40 €
FTPC60V12-FP FTPC60V24-FP	12V/ 5A 24V/ 2.5A	60W	172 x 59,5 x 18,5	49,51 €
FTPC100V12-FP FTPC100V24-FP	12V/ 8.33A 24V/ 4.17A	100W	167,5 x 52,8 x 17,5	70,68 €



IP44





GPV

- **Tensão Constante.**
(ENG) Constant Voltage Design.
(FR) Conçu pour Tension constant.
- **Tensão de entrada Universal / Espectro completo (excepto GPV-18).**
(ENG) Universal AC Input/ Full Range (except GPV-18).
(FR) Tension d'entrée universelle/à spectre complet (sauf GPV-18).
- **EN 55015, EN61347-2-13.**
- **Excelente relação qualidade - preço.**
(ENG) Excellent quality / price ratio.
(FR) Excellent rapport qualité/prix.
- **Arrefecimento por livre circulação de ar.**
(ENG) Cooling by free air convection.
(FR) Refroidissement avec circulation d'air libre.

Referência Reference / Référence	Output	Potência Power / Puissance	Dimensões (mm) Dimensions	PVP
GPV-12-12 GPV-12-24	12V/ 1A 24V/ 0.5A	12W	129,5 x 25 x 21	12,29 €
GPV-18-12 GPV-18-24	12V/ 1.5A 24V/ 0.75A	18W	129,5 x 25 x 21	13,08 €
GPV-35-5 GPV-35-12 GPV-35-15 GPV-35-24 GPV-35-36	5V/ 5A 12V/ 3A 15V/ 2.4A 24V/ 1.5A 36V/ 1A	25W 36W	149 x 32 x 28	20,76 €
GPV-50-12 GPV-50-24	12V/ 4A 24V/ 2A	48W	148 x 40 x 34	22,95 €
GPV-60-5 GPV-60-12 GPV-60-15 GPV-60-24 GPV-60-36	5V/ 8A 12V/ 5A 15V/ 4A 24V/ 2.5A 36V/ 1.67A	40W 60W	162x 42 x 33	25,99 €

Referência Reference / Référence	Output	Potência Power / Puissance	Dimensões (mm) Dimensions	PVP
GPV-75-12 GPV-75-24	12V/ 6A 24V/ 3A	72W	162x 42 x 33	30,99 €
GPV-100-12 GPV-100-24 GPV-100-36	12V/ 8.3A 24V/ 4.2A 36V/ 2.8A	100W 101W	187x 52 x 37	43,36 €
GPV-120-12 GPV-120-24	12V/ 10A 24V/ 5A	120W	203 x 70 x45	64,43 €
GPV-150-12N GPV-150-24	12V/ 12.5A 24V/ 6A	150W 144W	203 x 70 x45	64,43 €
GPV-200-12 GPV-200-24	12V/ 16A 24V/ 8.3A	192W 199W	205 x 70 x45	82,23 €



IP67

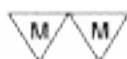

SELV



GLSV



- **Tensão Constante.**
(ENG) Constant Voltage Design.
(FR) Conçu pour Tension constant.
- **Função PFC activo, PF > 0,96 (Carga Total)**
(ENG) Built-in active PFC function, PF > 0,96 (Full Load)
(FR) Fonction PFC active intégrée, PF > 0,96 (Pleine Charge)
- **Proteção de Sobrecarga: DM-5KV, CM-10KV.**
(ENG) Surge Immunity: DM-5KV, CM-10KV.
(FR) Immunité contre les surtensions : DM-5KV, CM-10KV.
- **EN 55015, EN61000-3-2.**

Referência Reference / Référence	Output	Potência Power / Puissance	Dimensões (mm) Dimensions	PVP
GLSV-035B12	12V/ 2.9A	35W	199 x 42,5 x 34	41,76 €
GLSV-035B24	24V/ 1.46A			
GLSV-035B36	36V/ 0.97A			
GLSV-035B48	48V/ 0.73A			
GLSV-050B12	12V/ 4.17A	50W	199 x 42,5 x 34	45,55 €
GLSV-050B24	24V/ 2.08A			
GLSV-050B36	36V/ 1.39A			
GLSV-050B48	48V/ 1.04A			
GLSV-075B12	12V/ 6.25A	75W	164 x 68 x 39	50,31 €
GLSV-075B24	24V/ 3.13A			
GLSV-075B36	36V/ 2.08A			
GLSV-075B48	48V/ 1.56A			
GLSV-100B12	12V/ 8.33A	100W	178 x 68 x 39	62,65 €
GLSV-100B24	24V/ 4.17A			
GLSV-100B36	36V/ 2.78A			
GLSV-100B48	48V/ 2.08A			

Referência Reference / Référence	Output	Potência Power / Puissance	Dimensões (mm) Dimensions	PVP
GLSV-150B12	12V/ 12.5A	150W	207x 68 x 39	70,64 €
GLSV-150B24	24V/ 6.25A			
GLSV-150B36	36V/ 4.17A			
GLSV-150B48	48V/ 3.13A			
GLSV-200B12	12V/ 16.67A	200W	234x 68 x 43,5	87,78 €
GLSV-200B24	24V/ 8.33A			
GLSV-200B36	36V/ 5.56A			
GLSV-200B48	48V/ 4.17A			
GLSV-320B12	12V/ 22A	264W	234x 98 x 40	158,41 €
GLSV-320B24	24V/ 13.33A	320W		
GLSV-320B36	36V/ 8.9A			
GLSV-320B48	48V/ 6.67A			



IP67



SELV



GTPC S

- **Tensão Constante.**
(ENG) Constant Voltage Design.
(FR) Conçu pour Tension constant.
- **Tensão de Entrada Europeia 220 - 240 VAC.**
(ENG) EU AC Input Range 220 - 240 VAC.
(FR) Plage d'Entrée CA Européenne 220 - 240 VAC.
- **Capacidade de carga standard.**
(ENG) Standard reference load.
(FR) Capacité de charge standard.
- **Filtro ativo de fator de correção de potência (PFC).**
(ENG) Built-In active PFC function.
(FR) Fonction PFC active intégrée.
- **Encapsulamento extra fino e estreito.**
(ENG) Extra thin and narrow encapsulation.
(FR) Taille de boîtier extra fine et étroite.
- **Arrefecimento por livre circulação de ar.**
(ENG) Cooling by free air convection.
(FR) Refroidissement avec circulation d'air libre.

Referência Reference / Référence	Output	Potência Power / Puissance	Dimensões (mm) Dimensions	PVP
GTPC-30-S-12	12V/ 2.5A	30W	251 x 30 x 16,5	26,24 €
GTPC-30-S-24	24V/ 1.25A			
GTPC-45-S-12	12V/ 3.75A	45W	251 x 30 x 16,5	26,58 €
GTPC-45-S-24	24V/ 1.87A			
GTPC-60-S-12	12V/ 5A	60W	305 x 30 x 17	39,85 €
GTPC-60-S-24	24V/ 2.5A			
GTPC-75-S-12	12V/ 6.25A	75W	305 x 30 x 17	44,88 €
GTPC-75-S-24	24V/ 3.125A			
GTPC-100-S-12	12V/ 8.34A	100W	320 x 30 x 18,2	49,00 €
GTPC-100-S-24	24V/ 4.17A			
GTPC-150-S-12	12V/ 11A	132W	335 x 30 x 21,6	59,22 €
GTPC-150-S-24	24V/ 6,25A			
GTPC-200-S-24	24V/ 8,33A	200W	335 x 30 x 21,6	64,56 €
GTPC-240-S-24	24V/ 10A	240W	360 x 32,1 x 22,5	98,28 €





GTPC D



- **Tensão de Entrada Europeia.**
(ENG) EU AC Input Range.
(FR) Plage d'Entrée AC Européenne.
- **Tensão Constante.**
(ENG) Constant Voltage Design.
(FR) Conçu pour Tension constant.
- **Adequado para trabalhar com AC Triac Dimmer.**
(ENG) Suitable to work with AC Triac Dimmer.
(FR) Convient pour fonctionner avec le Dimmer AC Triac.
- **Proteções: Sobrecarga / Sobretensão / Curto-circuito.**
(ENG) Protections: Overload / Over Voltage / Short Circuit.
(FR) Protections : Surcharge / Surtension / Court-circuit.
- **Arrefecimento por livre circulação de ar.**
(ENG) Cooling by free air convection.
(FR) Refroidissement avec circulation d'air libre.
- **Certificado CB, EN 61347-2-13.**
(ENG) CB Certificate, EN 61347-2-13.
(FR) Certificat CB, EN 61347-2-13.

Referência Reference / Référence	Output	Potência Power / Puissance	Dimensões (mm) Dimensions	PVP
GTPC-25-D-12 GTPC-25-D-24	12V/ 2.08A 24V/ 1.04A	25W	122 x 52 x 30	21,26 €
GTPC-50-D-12 GTPC-50-D-24	12V/ 4.16A 24V/ 2.08A	50W	166 x 52 x 32	34,95 €
GTPC-100-D-12 GTPC-100-D-24	12V/ 8.3A 24V/ 4.2A	100W	210 x 67 x 34	80,13 €



SELV



MPL 03

- **Corrente Constante.**
(ENG) Constant Current.
(FR) Conçu pour Courant constant.
- **Tensão de Entrada Europeia.**
(ENG) EU AC Input Range.
(FR) Plage d'Entrée CA Européenne.
- **Preço acessível.**
(ENG) Low price.
(FR) Prix accessible.
- **Arrefecimento por livre circulação de ar.**
(ENG) Cooling by free Air convection.
(FR) Refroidissement avec circulation d'air libre.
- **Proteção: Curto-circuito / Sobrecarga.**
(ENG) Protection: Short circuit / Overload.
(FR) Protection: Court-circuit / Surcharge.

Referência Reference / Référence	Output	Potência Power / Puissance	Dimensões (mm) Dimensions	PVP
MPL-03-350LC	6V - 12V / 350 mA	3W	53 x 37 x 26 x 21	7,72 €
MPL-03-700LC	2,5V - 4,2V / 700 mA			8,97 €
MPL-03-350	0,5V - 10V / 350 mA	3W	53 x 37 x 26 x 21	8,97 €
MPL-03-700	0,5V - 4V / 700 mA			9,72 €



MW POWER



IP65

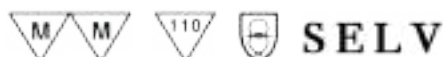



MPLC 12/16



- **Corrente Constante.**
(ENG) Constant Current.
(FR) Conçu pour Courant constant.
- **Tensão de Entrada Europeia.**
(ENG) EU AC Input Range.
(FR) Plage d'Entrée CA Européenne.
- **Função PFC activo, PF ≥ 0.8**
(ENG) Built-in active PFC function, PF ≥ 0.8
(FR) Fonction PFC active intégrée, PF ≥ 0.8
- **Arrefecimento por livre circulação de ar.**
(ENG) Cooling by free Air convection.
(FR) Refroidissement avec circulation d'air libre.
- **Proteção: Curto-circuito / Sobrecarga.**
(ENG) Protection: Short circuit / Overload.
(FR) Protection: Court-circuit / Surcharge.
- **EN 55015, EN61000-3-2.**

Referência Reference / Référence	Output	Potência Power / Puissance	Dimensões (mm) Dimensions	PVP
MPLC-12-350	17V - 34V / 350mA	11.9W	88 x 39 x 22,5	12,14 €
MPLC-12-700	9V - 17V / 700mA			
MPLC-16-350	23V - 46V / 350mA	16W	115 x 45 x 27,5	14,66 €
MPLC-16-700	12V - 23V / 700mA			





MPL 06

- **Tensão Constante.**
(ENG) Constant Voltage Design.
(FR) Conception à Tension constante.
- **Tensão de Entrada Europeia.**
(ENG) EU AC Input Range.
(FR) Plage d'Entrée CA Européenne.
- **EN 55015, EN61000-3-2.**
- **Arrefecimento por livre circulação de ar.**
(ENG) Cooling by free Air convection.
(FR) Refroidissement avec circulation d'air libre.
- **Proteção: Curto-circuito / Sobrecorrente / Sobretensão.**
(ENG) Protection: Short circuit / Over current / Over voltage.
(FR) Protection : Court-circuit / Surintensité / Surtension.

Referência Reference / Référence	Output	Potência Power / Puissance	Dimensões (mm) Dimensions	PVP
MPL-06-12LC	12V/ 0.5A	6W	52 x 21 x 43,5	6,73 €
MPL-06-24LC	24V/ 0.25A			





MPL 12



- **Tensão Constante.**
(ENG) Constant Voltage Design.
(FR) Conception à Tension constante.
- **Tensão de Entrada Europeia.**
(ENG) EU AC Input Range.
(FR) Plage d'Entrée CA Européenne.
- **EN 55015, EN61000-3-2.**
- **Arrefecimento por livre circulação de ar.**
(ENG) Cooling by free air convection.
(FR) Refroidissement avec circulation d'air libre.
- **Proteção: Curto-circuito / Sobrecorrente / Sobretensão.**
(ENG) Protection: Short circuit / Over current / Over voltage.
(FR) Protection : Court-circuit / Surintensité / Surtension.

Referência Reference / Référence	Output	Potência Power / Puissance	Dimensões (mm) Dimensions	PVP
MPL-12-12LC	12V/ 1A	12W	100 x 42 x 24,5	9,91 €





MPL 16 LC

- **Tensão Constante.**
(ENG) Constant Voltage Design.
(FR) Conception à Tension constante.
- **Tensão de Entrada Europeia.**
(ENG) EU AC Input Range.
(FR) Plage d'Entrée CA Européenne.
- **EN 55015, EN61000-3-2.**
- **Arrefecimento por livre circulação de ar.**
(ENG) Cooling by free air convection.
(FR) Refroidissement avec circulation d'air libre.
- **Proteção: Curto-circuito / Sobrecorrente / Sobretensão.**
(ENG) Protection: Short circuit / Over current / Over voltage.
(FR) Protection : Court-circuit / Surintensité / Surtension.

Referência Reference / Référence	Output	Potência Power / Puissance	Dimensões (mm) Dimensions	PVP
MPL-16-12LC	12V/ 1.25A	15W	115 x 45 x 27,5	13,54 €
MPL-16-24LC	24V/ 0.625A			





ACCESSORIES

EPLUS ACCESSORIES é um grupo de acessórios completamente adaptado para auxiliar as instalação dos nossos artigos. Uma seleção escolhida e testada, para tornar a nossa marca Eplus LIGHTING não só uma referência em termos de qualidade, mas igualmente uma marca completa, com a capacidade de acompanhar as necessidades dos nossos clientes, do início ao fim.

(ENG) EPLUS ACCESSORIES is a group of accessories completely adapted to help with the installation of our articles. A selection chosen and tested, to make our Eplus LIGHTING brand not only a reference in terms of quality, but also a complete brand, with the ability to accompany our customers' needs, from beginning to end.

(FR) EPLUS ACCESSORIES c'est un groupe d'accessoires complètement adapté pour assister l'installation de nos articles. Une sélection choisie et testée pour faire de notre marque Eplus LIGHTING non seulement une référence en termes de qualité, mais aussi une marque complète, avec la capacité de suivre les besoins de nos clients du début à la fin.



	ACCESSORIES
 INTERRUPTORES (ENG) SWITCHES (FR) INTERRUPTEUR	160 - 161
ACESSÓRIOS para fita LED (ENG) ACCESSORIES for LED strip (FR) ACCESSOIRES pour bande LED	162 - 165
LIGAÇÃO (ENG) CONNECTIONS (FR) LIENS	166
 FIXAÇÃO (ENG) FIXATION (FR) FIXATION	167
FIO PARALELO (ENG) PARALLEL WIRE (FR) FIL PARALLÈLE	168
 EXTENSÕES COM FICHA (ENG) EXTENSIONS CABLE WITH PLUG (FR) CABLES AVEC FICHE MÂLE	169
MANGA TERMORETRÁTIL (ENG) THERMORETCHABLE SLEEVE (FR) GAINE THERMORÉTRATABLE	170
FERROS & FIO DE SOLDAR (ENG) SOLDERING IRON & WIRE (FR) FER & FIL À SOUDER	

INTERRUPTORES

(ENG) SWITCHES (FR) INTERRUPTEUR

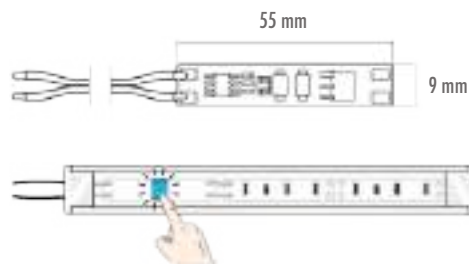
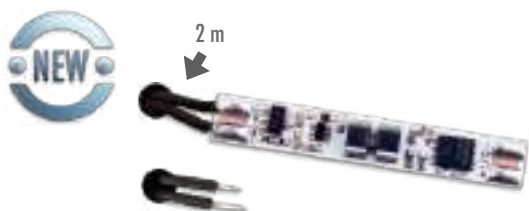

Referência Reference / Référence	Input	Output	Descrição Description	PVP
WYL-XC60-NI-02W	12-24VDC	Max. 5A 60W(12VDC) / 120W(24VDC)	Interruptor de Toque com LED (azul) integrado para facilitar o seu uso. (ENG) Touch switch with LED (blue) for easy use. (FR) Interrupteur tactile avec LED intégrée (bleu) pour une utilisation facile.	12,53 €

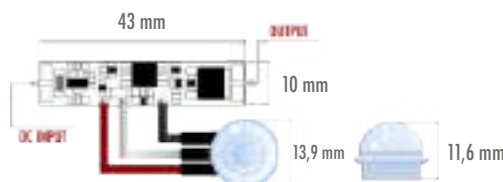

Referência Reference / Référence	Input	Output	Descrição Description	PVP
CTR-130SENSMOV8A	12-24VDC	Max. 8A 96W(12VDC) / 192W(24VDC)	Interruptor com sensor de movimento ideal para mobiliário. Liga automaticamente ao captar qualquer movimento até a uma distância de 2m, desligando de forma independente passado 40 segundos. (ENG) Switch with motion sensor ideal for furniture. It turns on automatically when capturing any movement up to a distance of 2m, turning off independently after 40 seconds. (FR) Interrupteur avec détecteur de mouvement idéal pour le mobilier. Il s'allume automatiquement lors de la capture de tout mouvement jusqu'à une distance de 2 m et s'éteignant indépendamment après 40 secondes.	17,90 €



IP67

Referência Reference Référence	Input	Output	Descrição Description	PVP
INT-IP67-GR	12VDC / 230V AC	Max. 5A (12VDC / 230V AC)	Interruptor manual de alta resistência em aço endurecido, com LED (verde) para facilitar o seu uso. (ENG) High strength manual switch in hardened steel, with LED (green) to facilitate its use. (FR) Interrupteur manuel à haute résistance en acier trempé, avec LED (verte) pour faciliter son utilisation.	15,39 €

INTERRUPTORES

(ENG) SWITCHES (FR) INTERRUPTEUR

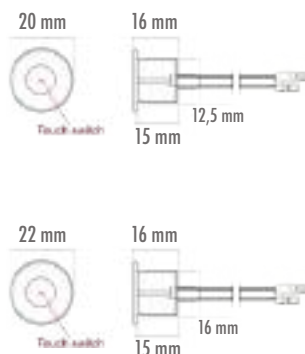

Referência Reference / Référence	Input	Output	Descrição Description	PVP
WYL-SENS-36W-CH-02			Interruptor de embutir ideal para mobiliário, com opção ON/OFF (com um toque < 1 seg.) e DIMÁVEL (com um toque contínuo > 1 seg.). Acabamentos disponíveis em CROMADO, BRANCO e PRETO. (ENG) Recessed switch ideal for furniture, with ON/OFF option (with a touch < 1 sec.) and DIMMABLE (with a continuous touch > 1 sec.). Finishes available in CHROME, WHITE and BLACK. (FR) Interrupteur encastré idéal pour les meubles, avec option ON/OFF (avec une touche < 1 sec.) et DIMMABLE (avec une touche continue > 1 sec.). Finitions disponibles en CHROME, BLANC et NOIR.	15,75 €
WYL-SENS-36W-BI-02	12-24VDC	Max. 3A 36W(12VDC) / 72W(24VDC)		
WYL-SENS-36W-CZ-02				

































Referência Reference Référence	Input	Output	Descrição Description	PVP
INT-0/1-W			Interruptor manual com função ON/OFF. Disponível em BRANCO, PRETO, CINZENTO e CASTANHO. (ENG) Manual switch with ON/OFF function. Available in WHITE, BLACK, GRAY and BROWN. (FR) Interrupteur manuel avec fonction ON/OFF. Disponible en BLANC, NOIR, GRIS et MARRON.	1,60 €
INT-0/1-B	12VDC / 230V AC	Max. 6A (12VDC / 230V AC)		
INT-0/1-G				
INT-0/1-BN				
INT-AR-W	12VDC / 230V AC	Max. 2A (12VDC / 230V AC)	Interruptor para porta comum ou porta de correr, com função ON/OFF. Disponível em BRANCO e PRETO. (ENG) Switch for common door or sliding door, with ON/OFF function. Available in WHITE and BLACK. (FR) Interrupteur pour porte commune ou porte coulissante, avec fonction ON/OFF. Disponible en BLANC et NOIR.	5,73 €
INT-AR-B				

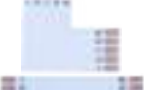

ACESSÓRIOS para fita LED

(ENG) ACCESSORIES for LED strip (FR) ACCESSOIRES pour bande LED

	Referência Reference Référence	Largura Width Largeur	Saídas Output Sorties	Corrente Current Courant	PVP		Referência Reference Référence	Largura Width Largeur	Saídas Output Sorties	Corrente Current Courant	PVP
	CNT-998U	8 mm	x 2	4A	0,50 €		CNT-9910UCRGB	10 mm	x 2	4A	1,20 €
	CNT-9910U	10 mm	x 2	4A	0,50 €		CNT-9912UCRGBW	12 mm	x 2	4A	1,20 €
	CNT-9910URGB	10 mm	x 2	4A	0,95 €		CNT-998UCCOB	8 mm	x 2	4A	2,81 €
	CNT-9912URGBW	12 mm	x 2	4A	0,95 €		CNT-998ACCOB	8 mm	x 1	4A	1,50 €
	CNT-998UL	8 mm	x 2	4A	1,50 €		CNT-998L	8 mm	x 2	4A	0,40 €
	CNT-9910UL	10 mm	x 2	4A	1,50 €		CNT-998T	8 mm	x 3	4A	0,50 €
	CNT-9910ULRGB	10 mm	x 2	4A	1,50 €		CNT-998X	8 mm	x 4	4A	0,50 €
	CNT-998UT	8 mm	x 3	4A	1,50 €		CNT-9910L	10 mm	x 2	4A	0,40 €
	CNT-9910UT	10 mm	x 3	4A	1,90 €		CNT-9910T	10 mm	x 3	4A	0,50 €
	CNT-9910UTRGB	10 mm	x 3	4A	1,90 €		CNT-9910X	10 mm	x 4	4A	0,50 €
	CNT-998UX	8 mm	x 4	4A	2,00 €		CNT-9910LRGB	10 mm	x 2	4A	0,40 €
	CNT-9910UX	10 mm	x 4	4A	2,00 €		CNT-9910TRGB	10 mm	x 3	4A	0,50 €
	CNT-9910UXRGB	10 mm	x 4	4A	2,50 €		CNT-9910XRGB	10 mm	x 4	4A	0,50 €
	CNT-998UCOB	8 mm	x 2	4A	1,30 €		CNT-9912LRGBW	12 mm	x 2	4A	0,50 €
	CNT-998UC	8 mm	x 2	4A	1,00 €		CNT-9912TRGBW	12 mm	x 3	4A	0,60 €
	CNT-9910UC	10 mm	x 2	4A	1,00 €		CNT-9912XRGBW	12 mm	x 4	4A	0,60 €









ACESSÓRIOS para fita LED

(ENG) ACCESSORIES for LED strip (FR) ACCESSOIRES pour bande LED

	Referência Reference Référence	Descrição Description	Corrente Current Courant	PVP
	CNT-9910ACF	DC SOCKET 2.1x 5.5mm + CLIP 10mm PRISE DC 2.1x 5.5mm + CLIP 10mm	4A	1,30 €
	CNT-023512M	DC PLUG 2.1x 5.5mm + Terminais de Parafuso DC PLUG 2.1x 5.5mm + Screw Terminals FICHE DC 2.1x 5.5mm + Bornes à Vis	10A	0,70 €
	CNT-023512	DC SOCKET 2.1x 5.5mm + Terminais de Parafuso DC SOCKET 2.1x 5.5mm + Screw Terminals PRISE DC 2.1x 5.5mm + Bornes à Vis	10A	0,70 €
	CNT-996PLUGPR	Repartidor c/Mini Ficha x6 Saídas Distributor w/Mini Sheet x6 Outputs Distributeur avec Mini Fiche x6 Sorties	3A	4,50 €
	CNT-996PLUGBR	Repartidor c/Mini Ficha x6 Saídas Distributor w/Mini Sheet x6 Outputs Distributeur avec Mini Fiche x6 Sorties	3A	4,50 €
	CNT-993PLUGPR	Repartidor c/Mini Ficha x3 Saídas Distributor w/Mini Sheet x3 Outputs Distributeur avec Mini Fiche x3 Sorties	3A	3,80 €
	CNT-993PLUGBR	Repartidor c/Mini Ficha x3 Saídas Distributor w/Mini Sheet x3 Outputs Distributeur avec Mini Fiche x3 Sorties	3A	3,80 €
	CNT-99UMFC2M	União de Repartidores Union of Distributors Union des Distributeurs	8A	1,50 €
	CNT-998AC2M	Mini Ficha de Repartição + CLIP 10mm Distributors Mini Sheet + CLIP 10mm Mini Fiche de Distributeur + CLIP 10mm	8A	1,50 €
	CNT-993135M	Conector c/ Cabo 14cm MACHO Connector w/ 14cm MALE Cable Connecteur avec câble MALE 14cm	15A	0,95 €
	CNT-993135F	Conector c/ Cabo 14cm FÊMEA Connector w/ 14cm FEMALE Cable Connecteur avec câble FEMELLE 14cm	15A	0,95 €

ACESSÓRIOS para fita LED

(ENG) ACCESSORIES for LED strip (FR) ACCESSOIRES pour bande LED

	Referência Reference Référence	Descrição Description	Canais Channels Canaux	PVP
	CNT-992CHIP65F	Ligador Rápido IP65 c/ Cabo 20 cm DC3-36V / Max. 5.9A FÊMEA IP65 Quick Connector w/ 20 cm Cable DC3-36V / Max. 5.9A FEMALE Connecteur Rapide IP65 avec câble de 20 cm DC3-36V / Max. 5.9A FEMELLE	x 2	1,30 €
	CNT-992CHIP65M	Ligador Rápido IP65 c/ Cabo 20 cm DC3-36V / Max. 5.9A MACHO IP65 Quick Connector w/ 20 cm Cable DC3-36V / Max. 5.9A MALE Connecteur Rapide IP65 avec câble de 20 cm DC3-36V / Max. 5.9A MALE	x 2	1,30 €
	CNT-993CHIP65F	Ligador Rápido IP65 c/ Cabo 20 cm DC3-36V / Max. 3.7A FÊMEA IP65 Quick Connector w/ 20 cm Cable DC3-36V / Max. 3.7A FEMALE Connecteur Rapide IP65 avec câble de 20 cm DC3-36V / Max. 3.7A FEMELLE	x 3	1,95 €
	CNT-993CHIP65M	Ligador Rápido IP65 c/ Cabo 20 cm DC3-36V / Max. 3.7A MACHO IP65 Quick Connector w/ 20 cm Cable DC3-36V / Max. 3.7A MALE Connecteur Rapide IP65 avec câble de 20 cm DC3-36V / Max. 3.7A MALE	x 3	1,95 €
	CNT-994CHIP65F	Ligador Rápido IP65 c/ Cabo 20 cm DC3-36V / Max. 2.3A FÊMEA IP65 Quick Connector w/ 20 cm Cable DC3-36V / Max. 2.3A FEMALE Connecteur Rapide IP65 avec câble de 20 cm DC3-36V / Max. 2.3A FEMELLE	x 4	2,55 €
	CNT-994CHIP65M	Ligador Rápido IP65 c/ Cabo 20 cm DC3-36V / Max. 2.3A MACHO IP65 Quick Connector w/ 20 cm Cable DC3-36V / Max. 2.3A MALE Connecteur Rapide IP65 avec câble de 20 cm DC3-36V / Max. 2.3A MALE	x 4	2,55 €
	CNT-995CHIP65F	Ligador Rápido IP65 c/ Cabo 20 cm DC3-36V / Max. 1.3A FÊMEA IP65 Quick Connector w/ 20 cm Cable DC3-36V / Max. 1.3A FEMALE Connecteur Rapide IP65 avec câble de 20 cm DC3-36V / Max. 1.3A FEMELLE	x 5	3,20 €
	CNT-995CHIP65M	Ligador Rápido IP65 c/ Cabo 20 cm DC3-36V / Max. 1.3A MACHO IP65 Quick Connector w/ 20 cm Cable DC3-36V / Max. 1.3A MALE Connecteur Rapide IP65 avec câble de 20 cm DC3-36V / Max. 1.3A MALE	x 5	3,20 €

ACESSÓRIOS para fita LED

(ENG) ACCESSORIES for LED strip (FR) ACCESSOIRES pour bande LED

	Referência Reference Référence	Descrição Description	PVP
	EPLUS-9945GSILICONE	EPLUS Bisnaga 45g Cola Silicone EPLUS Tube 45g Silicone Glue EPLUS Tube 45g Colle Silicone	5,65 €
	ELED-ENDCAP8MM	Topo de 10 mm para Fita LED de 8mm 10mm End Cap for 8mm LED strip Embout 10 mm pour Ruban LED de 8 mm	0,25 €
	ELED-ENDCAP10MM	Topo de 12 mm para Fita LED de 10mm 12mm End Cap for 10mm LED strip Embout 12 mm pour Ruban LED de 10 mm	0,25 €
	CLIP-998MM	Clip para Fita LED de 8mm 8mm LED Strip Clip Clip pour Ruban LED de 8 mm	0,10 €
	CLIP-9910MM	Clip para Fita LED de 10mm 10mm LED Strip Clip Clip pour Ruban LED de 10 mm	0,10 €
	CLIP-9912MM	Clip para Fita LED de 12mm 12mm LED Strip Clip Clip pour Ruban LED de 12 mm	0,10 €
	CLIP-9910MMSILICONE	Clip em Silicone para Fita LED de 10mm 10mm Silicone LED Strip Clip Clip en Silicone pour Ruban LED de 10 mm	0,35 €
	CLIP-9912MMSILICONE	Clip em Silicone para Fita LED de 12mm 12mm Silicone LED Strip Clip Clip en Silicone pour Ruban LED de 12 mm	0,35 €

LIGAÇÃO

(ENG) CONNECTIONS (FR) LIENS



Referência Reference Référence	Descrição Description	Saídas Output Sorties	PVP
MTE-38221412	2x 0,14 - 0,4 mm x 100 Uni.	x 2	0,73 €
MTE-38MO223413	3x 0,14 - 0,4 mm x 50 Uni.	x 3	0,92 €
MTE-991415	5x 0,14 - 0,4 mm x 25 Uni.	x 5	1,43 €



MTE-99SLUY2	2x 0,4 - 0,9 mm IP65 24V x 100 Uni.	x 2	0,17 €
MTE-990465	3x 0,4 - 0,9 mm IP65 24V x 100 Uni.	x 3	0,45 €
MTE-993M314	3x 0,5 - 1,5 mm IP65 230V x 50 Uni.	x 3	1,28 €



MTE-99U2C9A União 2 Condutores 0,35 - 0,50 mm² | 300V | x 100 Uni.
Union 2 Conductors
Union 2 Conducteurs x 4 1,25 €



MTE-99D1C9A Derivador 1 Condutores 0,35 - 0,50 mm² | 300V | x 100 Uni.
Derivator 1 Conductor
Dérivateur 1 Conducteur x 3 0,85 €



MTE-99D2C9A Derivador 2 Condutores 0,35 - 0,50 mm² | 300V | x 100 Uni.
Derivator 2 Conductors
Dérivateur 2 Conducteurs x 6 1,41 €

FIXAÇÃO

(ENG) FIXATION (FR) FIXATION





















Referência Reference Référence	Modelo Medidas Model Measures Modèle Mesures	Descrição Description	PVP
MTE-993M110GF12	GPH-110GF 12 mm x 33 m		52,61 €
MTE-993M110GF19	GPH-110GF 19 mm x 33 m	Fita de Espuma Acrílica Acrylic Foam Tape Ruban de Mousse Adhésif Acrylique	71,59 €
MTE-993M110GF25	GPH-110GF 25 mm x 33 m		94,36 €
MTE-993M4910F	4910F 19 mm x 11 m (BLISTER)	Fita de Espuma Acrílica Transparente Transparent Acrylic Foam Tape	70,51 €
MTE-993M4910F12	4910F 12 mm x 33 m	Ruban de Mousse Adhésif Acrylique Transparent	102,06 €
GPT020-9MM	GPT 020 9 mm x 50 m		17,50 €
GPT020-19MM	GPT 020 19 mm x 50 m	Fita de Dupla Face Double Sided Tape Ruban Adhésif Double Face	30,37 €
GPT020-25MM	GPT 020 25 mm x 50 m		49,11 €
MTE-993M9508W19MMPR	9508W 19 mm x 66 m PRETO / BLACK / NOIRE	Fita de Dupla Face Poliuretano Polyethylene Double Sided Foam Tape	49,11 €
MTE-993M9508W19MMBR	9508W 19 mm x 66 m BRANCO / WHITE / BLANC	Ruban de Mousse Polyéthylène Double Face	
MTE-993M550FCPR	550FC PRETO / BLACK / NOIRE	Mastique Poliuretano Rápido 310 ml Fast Polyurethane Putty 310 ml	15,43 €
MTE-993M550FCBR	550FC BRANCO / WHITE / BLANC	Mastic Polyuréthane Prise Rapide 310 ml	

FIO PARALELO

(ENG) PARALLEL WIRE (FR) FIL PARALLÈLE

- **Condutores CCA.**
(ENG) CCA Conductors.
(FR) Conducteurs CCA.
- **Rolos de 100 m.**
(ENG) 100m Rolls..
(FR) Bobine de 100m.
- **Polarizado.**
(ENG) Polarized.
(FR) Polarisé.
- **Comunicação e Alimentação Eléctrica.**
(ENG) Communication and Power Supply.
(FR) Communication et Alimentation.
- **Metrado.**
(ENG) Marked meter by meter.
(FR) Mètre.
- **EN 50575 : 2014**
- **CPR , ECA.**

	Referência Reference Référence	Descrição Description	Uni.	PVP (Rolo / Roll / Rouleau)
	MTE-99WIR9001	CCA 2x 0,5mm ² (14 x 0,21mm x 2)	x8	23,80 €
	MTE-99WIR9002	CCA 2x 0,75mm ² (20 x 0,21mm x 2)	x4	33,10 €
	MTE-99WIR9003	CCA 2x 1mm ² (28 x 0,21mm x 2)	x4	39,81 €
	MTE-99WIR9004	CCA 2x 1,5mm ² (42 x 0,21mm x 2)	x4	54,20 €
	MTE-99WIR9005	CCA 2x 2,5mm ² (50 x 0,24mm x 2)	x2	90,68 €
	MTE-99WIR9006	CCA 2x 4mm ² (80 x 0,24mm x 2)	x2	141,88 €
	MTE-99WIR9010	CCA 2x 0,5mm ² (14 x 0,21mm x 2)	x8	23,80 €
	MTE-99WIR9011	CCA 2x 0,75mm ² (20 x 0,21mm x 2)	x4	33,10 €
	MTE-99WIR9012	CCA 2x 1mm ² (28 x 0,21mm x 2)	x4	39,81 €
	MTE-99WIR9013	CCA 2x 1,5mm ² (42 x 0,21mm x 2)	x4	54,20 €
	MTE-99WIR9014	CCA 2x 2,5mm ² (50 x 0,24mm x 2)	x2	90,68 €
	MTE-99WIR9015	CCA 2x 4mm ² (80 x 0,24mm x 2)	x2	141,88 €
	MTE-99WIR9020	CCA 2x 0,5mm ² (14 x 0,21mm x 2)	x8	23,80 €
	MTE-99WIR9021	CCA 2x 0,75mm ² (20 x 0,21mm x 2)	x4	33,10 €
	MTE-99WIR9022	CCA 2x 1mm ² (28 x 0,21mm x 2)	x4	39,81 €
	MTE-99WIR9023	CCA 2x 1,5mm ² (42 x 0,21mm x 2)	x5	54,20 €
	MTE-99WIR9024	CCA 2x 2,5mm ² (50 x 0,24mm x 2)	x2	90,68 €
	MTE-99WIR9025	CCA 2x 4mm ² (80 x 0,24mm x 2)	x3	141,88 €
	MTE-99FIORGBW	CCA 5x 0,32 mm ²	x1	182,00 €
	MTE-99FIORGB	CCA 4x 0,32 mm ²	x1	147,00 €
	MTE-99FIOCCT	CCA 3x 0,32 mm ²	x1	112,00 €

EXTENSÕES COM FICHA

(ENG) EXTENSIONS CABLE WITH PLUG (FR) CABLES AVEC FICHE MÂLE



Referência Reference / Référence	Descrição Description	PVP
MTE-99EXT150BR	Extensão com ficha macho (EURO), com 2 x 0,75mm ² e 2m comprimento. Disponível em BRANCO e PRETO.	4,88 €
MTE-99EXT150PR	(ENG) Extension cable with male plug (EURO) measuring 2 x 0.75mm ² and 2m long. Available in WHITE and BLACK. (FR) Câble électrique avec fiche mâle (EURO) mesurant 2 x 0,75mm ² et 2m de long. Disponible en BLANC et NOIR.	

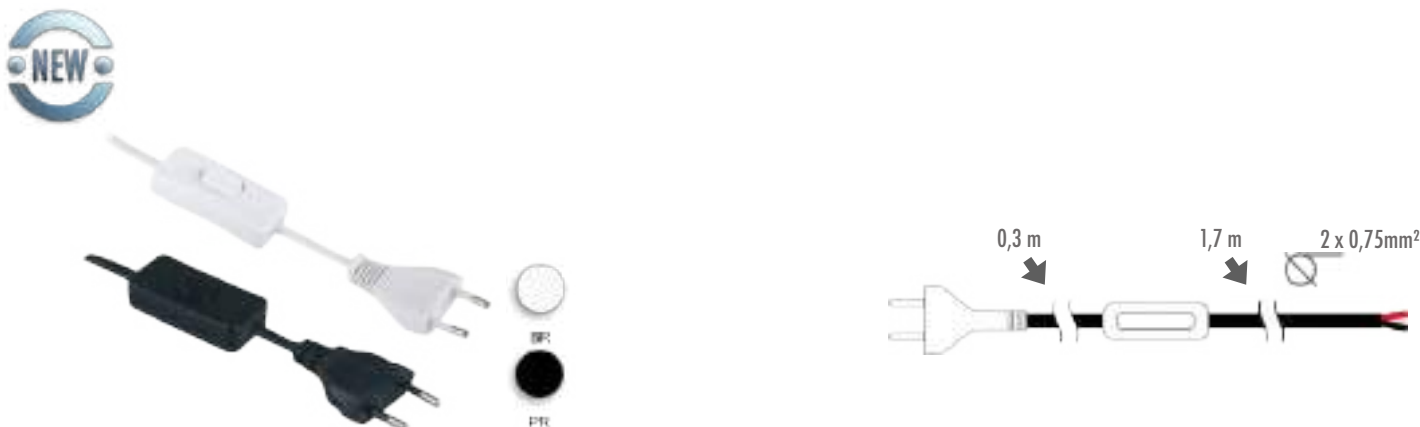

Referência Reference / Référence	Descrição Description	PVP
MTE-99EXT120*80INT-BR	Extensão com interruptor e uma ficha macho (EURO), com 2 x 0,75mm ² de diâmetro e 2m comprimento. Disponível em BRANCO e PRETO.	6,50 €
MTE-99EXT120*80INT-PR	(ENG) Extension cable with switch and a male plug (EURO), measuring 2 x 0.75mm ² and 2m long. Available in WHITE and BLACK. (FR) Câble électrique avec bouton et une fiche mâle (EURO) mesurant 2 x 0,75mm ² et 2m de long. Disponible en BLANC et NOIR.	

MANGA TERMORETRÁTIL

(ENG) THERMORETCHABLE SLEEVE (FR) GAINE THERMORÉTRATABLE



Referência Reference Référence	Medida Inicial Initial Measure Mesure initiale	Medida Final Final Measure Mesure finale	Qt. (m)	PVP
MTE-99HSR45PR	4,8 mm	2,25 mm	12 m	10,98 €
MTE-99HSR13PR	13,5 mm	6,5 mm	8m	10,98 €
MTE-99HSR20PR	20,7 mm	10 mm	5m	10,98 €
MTE-99HSR25PR	25,7 mm	12,5 mm	3m	10,98 €

FERROS & FIO DE SOLDAR





(ENG) SOLDERING IRON & WIRE (FR) FER & FIL À SOUDER



Referência Reference Référence	Descrição Description	PVP
MTE-99HRV120	Ferro de Soldar tipo Lápis 30W 220V - 240V Pencil Soldering Iron 30W 220V - 240V Fer à Souder type Crayon 30W 220V - 240V	22,75 €
MTE-99HRV8204	Ferro de Soldar de Dupla Potência 30W - 60W 220V - 240V Dual Power Soldering Iron 30W - 60W 220V - 240V Fer à Souder à Double Puissance 30W - 60W 220V - 240V	18,05 €
MTE-99EST119	Fio de Estanho Tri-Metal EST 119 15g EST 119 Tri-Metal Tin Wire 15g Fil d'Étain Tri-Métal EST 119 15g	5,25 €

SERVIÇOS

(ENG) SERVICES (FR) PRESTATIONS DE SERVICE

	Tipo de serviço Kind of service Genre de service	Referência Reference Référence	Descrição Description	PVP
	Solda Solder Soudure	ESERVICE-WELD	Ponto de solda Welding point Point de soudure	2 €
		ESERVICE-INSTALL1	Aplicação de fita Led em PERFIL Application of Led strip in PROFILE Application de la bande Led dans le PROFIL	0,50 €/m
		ESERVICE-INSTALL2	Aplicação de fita adesiva dupla face em PERFIL Application of double-sided adhesive tape on PROFILE Application de ruban adhésif double face sur le PROFIL	0,50 €/m
	Aplicação de componentes Component assembly Assemblage de composants	ESERVICE-INSTALL3	Aplicação de componentes em PERFIL (Ex. sensor, interruptor, difusor, tampa, transformador, fixação, etc.) Application of components in PROFILE. (Eg. sensor, switch, diffuser, cover, transformer, fixture, etc.) Application des composants dans le PROFIL. (Ex. capteur, interrupteur, diffuseur, couvercle, transformateur, fixation, etc.)	2,5 €
		ESERVICE-INSTALL4	Aplicação de componentes em fita LED/NEON. (Ex. união, ficha, sensor, interruptor, tampa, extensão, etc.) Application of components in LED STRIP/NEON. (Eg. union, plug, sensor, switch, cover, extension, etc.) Application de composants en BANDE LED/NEON. (Ex. union, prise, capteur, interrupteur, couvercle, rallonge, etc.)	2,5 €
		ESERVICE-INSTALL5	Aplicação de uniões lineares ou de canto em PERFIS Application of linear or corner joints in PROFILES Application de joints linéaires ou d'angle dans les PROFILÉS	4 €
	Preparação de fontes Power supply preparation Préparation de l'alimentation électrique	ESERVICE-ASSEMBLE	Montagem de ficha no Input / Output Plug mounting at Input / Output Installation d'une fiche sur le Input / Output	2 €
	Etiquetagem Labeling Étiquetage	ESERVICE-LABEL	Aplicação de etiqueta específica do cliente Customer-specific label application Application d'étiquette spécifique du client	4 €
	Corte de perfil, fita led ou neon led Profile cutting, led tape or led neon Découpe de profil, ruban led ou néon led	ESERVICE-CUT	Corte à medida do perfil, da fita led ou do neon led (apenas corte) Cut to size profile, led strip or led neon (cut only) Découpe sur mesure sur profilé, bande led ou led néon (coupe uniquement)	0 €

CONDIÇÕES GERAIS DE VENDA (ENG) GENERAL CONDITIONS OF SALE (FR) CONDITIONS GENERALES DE VENTE

CATÁLOGO	Os dados deste catálogo estão corretos, exceto por erros tipográficos. Este catálogo atualiza os dados e características dos mesmos produtos presentes em catálogos anteriores. As imagens podem diferir da realidade. Reserva-se o direito de cancelar ou modificar qualquer um dos modelos, tamanhos, referências e especificações técnicas dos diferentes produtos deste catálogo sem aviso prévio. É proibida a reprodução total ou parcial deste catálogo sem o consentimento expresso da EPLUS LIGHTING.
PREÇOS	Os preços presentes no catálogo não incluem impostos. Os descontos comerciais atribuídos, podem ser alterados a qualquer momento, bastando a comunicação ao cliente.
ENVIOS	As encomendas efetuadas até às 17h30, serão expedidas no mesmo dia por transportadora. Encomendas de valor líquido superior a 200€ terão isenção de portes de envio. Qualquer problema detetado na receção das encomendas deverá ser reportado ao estafeta e anotado no documento de transporte. Os problemas decorrentes de envios, para serem aceites, deverão ser-nos reportados num prazo máximo de 48 horas.
DEVOLUÇÕES	São aceites pedidos de devolução até 30 dias após a data de fatura. Os artigos deverão estar nas mesmas condições aquando da sua expedição. O transporte de todas as devoluções é por conta e risco do cliente. É imperativo que os artigos se façam acompanhar de um documento que justifique a devolução e indique a fatura de compra. Artigos que pela quantidade ou especificidade não façam parte do nosso stock habitual não serão aceites para devolução.
GARANTIA	Todos os artigos têm, como regra geral, 2 anos de garantia após data de emissão de fatura, excepto nos artigos assinalados no catálogo. Quando o artigo apresenta avaria ou defeito de fabrico durante o período de garantia, o cliente deverá enviar o mesmo para análise técnica. O artigo poderá ser reparado, substituído ou devolvido ao cliente (por não aplicação de garantia), num prazo máximo de 30 dias úteis. O transporte de todos os artigos para garantia é por conta e risco do cliente. É imperativo que os artigos se façam acompanhar de um documento que indique a fatura de compra. Não serão assumidos custos de montagem e desmontagem de artigos avariados ou com defeito. O mesmo se aplica a quaisquer danos diretos ou indiretos decorrentes da avaria. Casos de avaria provocados por uso indevido ou desgaste normal do produto, não serão aceites para efeitos de garantia. Nomeadamente: -Uso impróprio ou negligente do artigo que pode causar danos irreversíveis, assim como variações de temperatura, contacto com a água, instalações elétricas mal executadas e catástrofes naturais. -Intervenção nos produtos, nomeadamente tentativas de reparação, manutenção inadequada, ligação a fontes de alimentação impróprias ou alterações nas mesmas, assim como cortes mal executados, que tenham sido efetuados pelo cliente. -A alteração de cor do produto com o tempo, devido a oxidação dos acabamentos.
LITÍGIO	Em caso de litígio é única e exclusivamente competente o Tribunal da Comarca de Viseu.
(ENG)	
CATALOG	The data in this catalog is correct, except for typographical errors. This catalog updates the data and characteristics of the same products present in previous catalogues. Images may differ from reality. It reserves the right to cancel or modify any of the models, sizes, references and technical specifications of the different products in this catalog without prior notice. Total or partial reproduction of this catalog is prohibited without the express consent of EPLUS LIGHTING.
PRICES	The prices shown in the catalog do not include taxes. The commercial discounts assigned can be changed at any time, simply by communicating to the customer.
SHIPMENTS	Orders placed before 5:30 pm will be shipped on the same day by carrier. Orders with a net value of more than €200 will be exempt from shipping costs. Any problem detected in the receipt of orders must be reported to the courier and noted on the transport document. Problems arising from shipments, to be accepted, must be reported to us within a maximum period of 48 hours.
RETURNS	Return requests are accepted up to 30 days after the invoice date. The articles must be in the same condition when they are shipped. Shipping of all returns is at the customer's risk and expense. It is imperative that the items are accompanied by a document justifying the return and indicating the purchase invoice. Items that, due to their quantity or specificity, are not part of our usual stock will not be accepted for return.
WARRANTY	As a general rule, all items have a 2-year warranty after the invoice issuance date, except for items marked in the catalogue. When the item has a fault or manufacturing defect during the warranty period, the customer must send it for technical analysis. The item can be repaired, replaced or returned to the customer (due to non-application of warranty), within a maximum period of 30 working days. Shipping of all warranty items is at the customer's risk and expense. It is imperative that the items are accompanied by a document indicating the purchase invoice. No costs will be assumed for the assembly and disassembly of damaged or defective items. The same applies to any direct or indirect damages resulting from the breakdown. Failures caused by misuse or normal wear and tear of the product will not be accepted for warranty purposes. Namely: - Improper or negligent use of the article that can cause irrecoverable damage, as well as variations in temperature, contact with water, poorly executed electrical installations and natural disasters. - Intervention in the products, namely repair attempts, inadequate maintenance, connection to improper power sources or alterations in them, as well as poorly executed cuts, which have been carried out by the customer. -The color change of the product over time, due to the oxidation of the finishes.
LITIGATION	In case of dispute, the Court of the Comarca de Viseu is solely and exclusively competent.
(FR)	
CATALOGUE	Les données de ce catalogue sont correctes, à l'exception des erreurs typographiques. Ce catalogue met à jour les données et les caractéristiques des mêmes produits présents dans les catalogues précédents. Les images peuvent différer de la réalité. Il se réserve le droit d'annuler ou de modifier sans préavis les modèles, tailles, références et spécifications techniques des différents produits de ce catalogue. Toute reproduction totale ou partielle de ce catalogue est interdite sans l'autorisation d'EPLUS LIGHTING.
PIX	Les prix indiqués dans le catalogue n'incluent pas les taxes. Les remises commerciales attribuées peuvent être modifiées à tout moment, simplement en communiquant avec le client.
EXPÉDITIONS	Les commandes passées avant 17h30 seront expédiées le jour même par transporteur. Les commandes d'une valeur nette supérieure à 200 € seront exemptées de frais de port. Tout problème détecté lors de la réception des commandes doit être signalé au transporteur et noté sur le document de transport. Pour que les problèmes liés aux envois, soient acceptés, ils doivent nous être signalés dans un délai maximum de 48 heures.
RETOURS	Les demandes de retour sont acceptées jusqu'à 30 jours après la date de facturation. Les articles doivent être dans le même état lorsqu'ils sont expédiés. L'expédition de tous les retours est aux risques et aux frais du client. Il est impératif que les articles soient accompagnés d'un document justifiant le retour et indiquant la facture d'achat. Les articles qui, en raison de leur quantité ou de leur spécificité, ne font pas partie de notre stock habituel ne seront pas acceptés en retour.
GARANTIE	En règle générale, tous les articles bénéficient d'une garantie de 2 ans à compter de la date d'émission de la facture, à l'exception des articles signalés dans le catalogue. Lorsque l'article présente une panne ou un défaut de fabrication pendant la période de garantie, le client doit l'envoyer pour analyse technique. L'article peut être réparé, remplacé ou retourné au client (pour non application de la garantie), dans un délai maximum de 30 jours ouvrés. L'expédition de tous les articles sous garantie est aux risques et aux frais du client. Il est impératif que les articles soient accompagnés d'un document indiquant la facture d'achat. Aucun frais ne sera assumé pour le montage et le démontage des articles endommagés ou défectueux. Il en est de même des dommages directs ou indirects résultant de la panne. Les défaillances causées par une mauvaise utilisation ou l'usure normale du produit ne seront pas acceptées à des fins de garantie. À savoir: -Une utilisation inappropriée ou négligente de l'article pouvant causer des dommages irréparables, ainsi que des variations de température, un contact avec l'eau, des installations électriques mal exécutées et des catastrophes naturelles. - Intervention sur les produits, à savoir tentatives de réparation, entretien inadéquat, raccordement à des sources d'alimentation inappropriées ou modifications de ceux-ci, ainsi que coupures mal exécutées, qui ont été effectuées par le client. -Le changement de couleur du produit au fil du temps, dû à l'oxydation des finitions.
LITIGE	En cas de litige, le tribunal de la Comarca de Viseu est seul et exclusivement compétent.



Inspired by light

e PROFILES **e** LED **e** NEON **e** SIGN **e** CONTROL **e** POWER ACCESSORIES



www.eplus.lighting



info@eplus.lighting



+351 232 093 154