



Mureva Styl,
simply brilliant



se.com

Life Is On

Schneider
Electric

Life Is On

Content

- 4 Presentation
- 12 Green Premium products
- 13 Inserts
For surface mounting and flush mounting
- 14 Accessories
For surface mounting and flush mounting
- 15 Boxes and frames
For surface mounting and flush mounting
- 16 Complete products
Surface mounting
Flush mounting
- 19 Technical information
- 23 Reference number overview



Fittings available in Polar White and Anthracite Grey



Mureva Styl, a range of IP55 equipment

At Schneider Electric, we strive towards **technological innovation** on a daily basis. Strict market regulations means developing ever more advanced innovation, to deliver efficiency, **convenience and safety** for you and for your customers.

The heart of this innovation is based on ergonomics - **enabling easy installation** for you and easy operation for occupants.

Mureva Styl is the end result of our research. Mureva Styl reinvents “ease of installation” of your equipment, and innovates - with a design that is **robust yet trendy and unique**.

Simplify your life by opting for **the comfort** that Mureva Styl brings.

More business for you, more satisfaction for your customers.



The latest innovations

- Smart LED technology for easy location in the dark
- A transparent cover to easily identify between switch and socket

Mureva Styl, a tough and robust design

The new robust design of Mureva Styl means you can now work with full confidence.

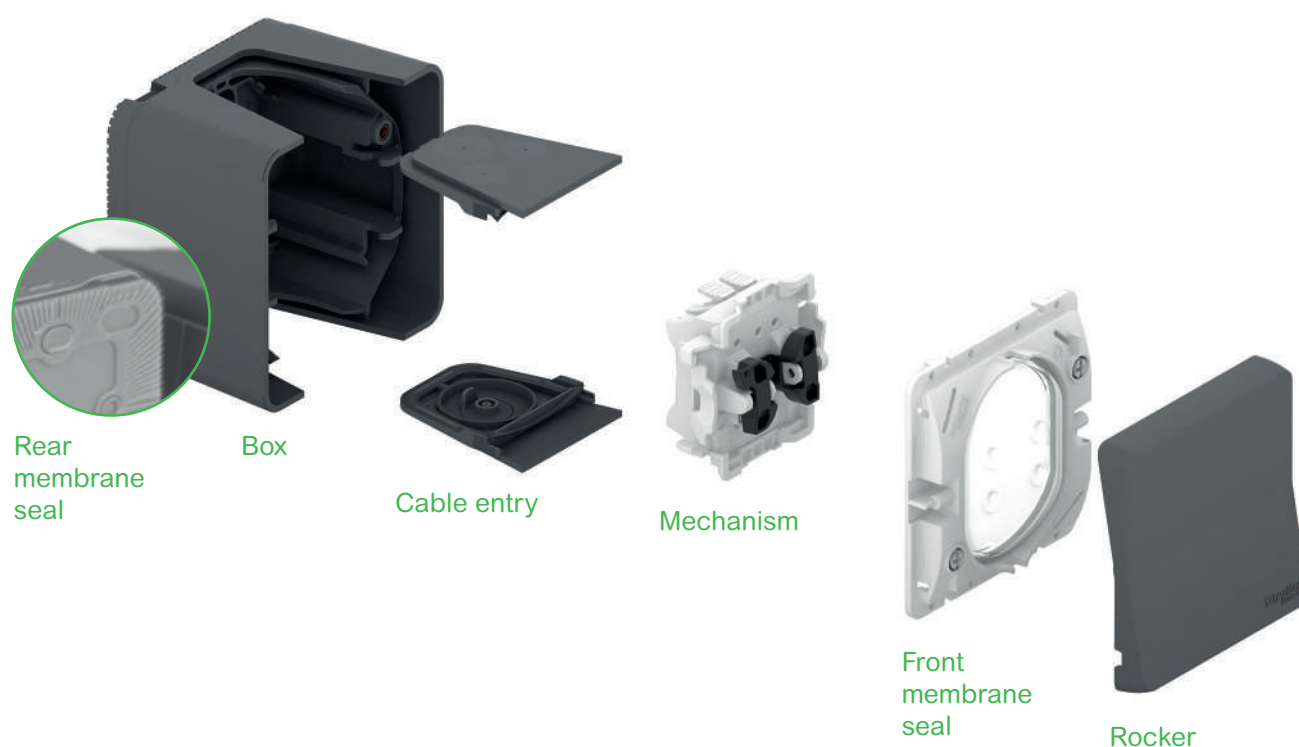

1 Components are reinforced with strong mechanism fittings, rigid enclosure boxes and frames as well as its waterproof rear membrane seal.

2 Because all its components are IP55 rated, Mureva Styl withstands the harshest of environment conditions:

- Waterproof, whether open or fitted,
- IK 08 classified for protection from knocks, - UV resistant, (meaning that the Polar White version suffers no discoloration),
- Dirt and dust resistant, as well as resistant to solvents...

Mureva Styl, an ergonomic design

The biggest advance is in its new ergonomic design which makes for a straightforward installation.

The Mureva Styl range is designed to be installed effortlessly, thanks to its intuitive and intelligent fitting design that is based on advanced ergonomics.

1 Now it's easy to connect your devices thanks to a insert that gives you plenty of wiring space...

2 ... Wiring is so simple. It clips and unclips easily.

3 Socket-outlets, switches and push-buttons can be easily illuminated with plug-and-play LED accessories or hardwired.

4 A standard switch can be easily be transformed into a push-button thanks to a simple spring mechanism and positioning aid.



Mureva Styl, a trendy design

The Mureva Styl range is not just easy to install and able to withstand all conditions, it has also been ingeniously designed with usability in mind.

Its curved profile goes perfectly with all ranges, and visually is a harmonious match with Schneider Electric ranges.

1 The two smart LEDs built into the sockets which is a Schneider Electric innovation make it easy to check when power is on. An innovative feature that also makes it easy to locate in the dark.

2 A transparent window cover replaces the opaque cover, meaning no more mistaking a switch with a socket.



Polar White or Anthracite Grey?

In line with current color trends for the residential and small-commercial markets, Mureva Styl is available in two colors: Polar White and Anthracite Grey. Polar White is discreet and suited to a variety of environments (hospitals, laboratories, warehouses for example...). Whereas, Anthracite Grey is stylish and perfectly suited to offices, garages, lofts and gardens. The plastic fittings are specially treated so that both models resist the build up of dust and dirt.



The Mureva Styl range, less inventory, more functionality

Reducing its number of components from 272 to just 90, the Mureva Styl range compromises none of its qualities at the expense of functionality.

A range that has been refined to deliver greater efficiency.

	Full product	Product components
<p>Mureva Styl New generation range</p> <p>  Anthracite Grey  Polar White </p> <p>  </p> <p>90 part numbers</p>		 <p>IP 55 for surface mounting & for flush mounting</p> <p>Only 2 part numbers to cost out and install and only one product to assemble : simple to cost out with an inventory that is optimized</p>

Brand features

The Mureva Styl range now brings you a number of new functions : emergency stop button, blind control, key-operated switch



Emergency stop button



Blind control



Key-operated switch

The Mureva range, a complete waterproof system

And to make installation even easier, Mureva Styl comprises a comprehensive waterproof range.

Surface-mounted

Mureva Box

A large selection of boxes wherever security and tightness are required



Mureva Tube

Designed to be bent without breaking, to ensure a perfectly aligned channel



Mureva Fix

Designed to ensure a time-proof quality and security in the fixation



Flush-mounted

Mureva Styl and Multifix Air flush-mounted box

Deeper for an optimal comfort of installation, they are strong and universal.



Green Premium™

Endorsing the most eco-friendly products in the industry



Green Premium™ Product

Green Premium is the only label that allows you to effectively develop and promote an environmental policy whilst preserving your business efficiency. This ecolabel guarantees compliance with the most up-to-date environmental regulations, but it does more than this.

Over 75 % of
Schneider Electric
manufactured products
have been awarded the
Green Premium ecolabel



Discover what we
mean by green

Check your products!

Schneider Electric's Green Premium ecolabel is committed to offering transparency, by disclosing extensive and reliable information related to the environmental impact of its products:

RoHS

Schneider Electric products are subject to RoHS requirements at a worldwide level, even for the many products that are not required to comply with the terms of the regulation. Compliance certificates are available for products that fulfil the criteria of this European initiative, which aims to eliminate hazardous substances.

REACH

Schneider Electric applies the strict REACH regulation on its products at a worldwide level, and discloses extensive information concerning the presence of SVHC (Substances of Very High Concern) in all of these products.

PEP: Product Environmental Profile

Schneider Electric publishes the most complete set of environmental data, including carbon footprint and energy consumption data for each of the lifecycle phases on all of its products, in compliance with the ISO 14025 PEP ecopassport program. PEP is especially useful for monitoring, controlling, saving energy, and/or reducing carbon emissions.

EoLI: End of Life Instructions

Available at the click of a button, these instructions provide:

- Recyclability rates for Schneider Electric products.
- Guidance to mitigate personnel hazards during the dismantling of products and before recycling operations.
- Parts identification for recycling or for selective treatment, to mitigate environmental hazards/ incompatibility with standard recycling processes.

Mureva Styl

Inserts

For surface mounting and flush mounting

Controls						CE	NF	EAC
	Single					Double		
	Two-way switch	Intermediate switch	2 pole switch	Push-button	Push-button with label holder	Double two-way switch	Double push-button	
White	MUR39723	MUR39023	MUR39033	MUR39027	MUR39129	MUR39022		
Anthracite	MUR37021	MUR35020	MUR35034	MUR35027	MUR34029	MUR35019	MUR35326	
Characteristics	10 AX	10 AX	16 AX	10 A	10 A	10 AX	10 A	
	250 V AC					250 V AC		
	screwless					screwless		
	IP55 ⁽¹⁾ - IK08					IP55 ⁽¹⁾ - IK08		

With lamp			
Two-way switch	Push-button	Double push-button	
White	MUR39024	MUR39127	MUR35228
Anthracite	MUR35025	MUR35127	
Characteristics	10 AX	10 A	10 A
	250 V AC		
	screwless		
	blue LED, 0.15 mA - 250 V		
	locator or indicator (not wired)	locator	locator (not wired)
	IP55 ⁽¹⁾ - IK08		

WiFi Repeater	
White	MUR39070
Anthracite	MUR35070
Characteristics	IP55 - IK07

Specialized controls					CE	EAC	CE	NF	EAC
with 2 positions	with 3 positions	Key to release	Turn to release	Push-button					
Anthracite	MUR35062	MUR35061	MUR35052	MUR35053	MUR35042				
Characteristics	screw terminals				screwless				
	key switches and emergency switches are with 3 A switches				10 A - 250 V AC				
	IP55 ⁽¹⁾ - IK08				IP55 ⁽¹⁾ - IK08				

Signalling device		CE	EAC
	with red lens for E14 incandescent or LED lamp		
Anthracite	MUR34526		
Characteristics	delivered without lamp		
	see "Lamp for light signal" page 14		
	screw terminals		
	5 W maximum		
	IP55 ⁽¹⁾ - IK08		

Socket-outlets				NF	EAC
French		German			
16 A 2P+E, shuttered pin-earth	16 A 2P+E, shuttered pin-earth	16 A 2P+E, shuttered side-earth	16 A 2P+E, shuttered side-earth		
White	MUR39133		MUR39134		
Anthracite	MUR36133	MUR38030	MUR36134	MUR39135	MUR36135
Characteristics	screwless	screw terminals	screwless	screw terminals	
	250 V AC - 50 Hz		250 V AC - 50 Hz		
	IP55 ⁽¹⁾ - IK08		IP55 ⁽¹⁾ - IK08		

⁽¹⁾ when installed in a box or frame

Surface mounting



Complete with a box
▶ page 15

Flush mounting



Complete with a frame
▶ page 15

Accessories

For surface mounting and flush mounting

Rockers			
	with bell symbol	with light symbol	for illumination, label holder
White	MUR39201	MUR39202	MUR39203
Anthracite	MUR34201	MUR34202	MUR34203
Characteristics	IP55 - IK08	IP55 - IK08	including label sheet with (blank+bell+light+key marking)

Rockers with lens		
	single	double
White	MUR39204	MUR39205
Anthracite	MUR34204	MUR34205
Characteristics	IP55 - IK08	IP55 - IK08

Cable outlet	
	for one cable
White	MUR37933
Anthracite	MUR37931
Characteristics	IP55 - IK08 for one cable 3 x 2.5 mm ²

Set of 10 cable entries		
	for 3 cables	for 1 tube
White	MUR39007	MUR39008
Anthracite	MUR35007	MUR35008
Characteristics	IP55 - IK08	ø tube: 6 mm min., 20 mm max.

10 sets of 2 covers for surface-box wall mounting screw head	
Anthracite	MUR34206

Set of 10 labelling sheet	
	MUR34004
	with blank + bell + light + key marking

Lamps for light signal		
	incandescent	LED
	MUR34555	MUR34556
Characteristics	for MUR34526 signalling device, see page 13	

LED lamps			
	Blue LED, 0.15 mA 250 V, wire	Blue LED, 0.15 mA 250 V, plug & play	Blue LED, 5 mA 12-48 V,dc plug & play
	S520291	S520292	S520293
Characteristics	for switches and socket-outlets for RL and special loads	for switches only	for switches only

Spring to transform a switch to push-button	
	Spring
	S520299
Characteristics	10 units, delivered in a plastic bag with a positioning aid tool note: push-button switches are suitable for 10 A loading only (not 10 AX)

Box cover with lid ⁽¹⁾	
	for New Unica range products
White	MUR39110
Anthracite	MUR35110
Characteristics	IP55 ⁽²⁾ - IK06

Surface mounting
 Complete with a box
 ▶ page 15

Flush mounting
 Complete with a frame
 ▶ page 15

⁽¹⁾ see page 20 and 21 of chapter "Technical informations", the table of Unica and New Unica range products compatible with these box covers with lid.
⁽²⁾ when installed in a box or frame.

Boxes and frames

For surface mounting and flush mounting

Boxes for surface mounting



1 gang

2 gangs, horizontal

2 gangs, vertical

3 gangs, horizontal

White **MUR39911**

MUR39914

MUR39912

MUR39913

Anthracite **MUR37911**

MUR37914

MUR37912

MUR37713

Characteristics IP55⁽¹⁾ - IK08

Frames for flush mounting



1 gang

1 gang, with claws

2 gangs, horizontal

2 gangs, vertical

3 gangs, horizontal

White **MUR39107**

MUR39108

MUR39101

MUR39151

MUR39109

Anthracite **MUR34107**

MUR34108

MUR34101

MUR34151









MUR34109

Characteristics IP55⁽¹⁾ (on flat/smooth walls only).

⁽¹⁾ when completed with covers

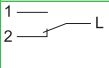
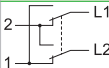
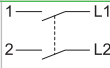
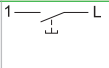
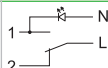
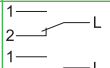
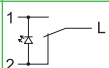
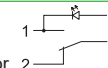

Complete products

Surface mounting





Controls								CE	NF	ER	ERC
	Single				Double		With lamp				
											
	Two-way	Intermediate	2 pole	Push-button	Two-way	Double two-way	Two-way	Push-button			
											
White	MUR39021 MUR40015 ^(D) MUR89021 ^(D)		MUR40007 ^(D)	MUR39026 MUR40009 ^(D) MUR89026 ^(D)	MUR39036 ^(D)	MUR40016	MUR40018 ^(D)	MUR40010 ^(D)			
Anthracite	MUR35021 MUR55021 ^(D)	MUR35023	MUR35033 MUR55033 ^(D)	MUR35026 MUR40019 ^(D) MUR85026 ^(D)	MUR35036 ^(D)	MUR35022 MUR55022 ^(D)	MUR35024 MUR55024 ^(D)	MUR35028			
Characteristics	10 AX 250 V AC screwless	10 AX	16 AX	10 A	10 A	10 AX 250 V AC screwless	10 AX 250 V AC screwless blue LED, 0.15 mA 250 V locator or indicator (not wired)	10 A locator			
	IP55 - IK08					IP55 - IK08		IP55 - IK08			

^(D) Available in DIY Packaging

Mechanical time delay switches		CE	ER
			
White	MUR39067		
Anthracite	MUR35067		
Characteristics	250 V AC up to 14 min. - adjustable steps: 2 min. screw terminals switching capacity: 10 A IP55 - IK08		

Socket-outlets + two-way switches				CE	NF	ER	ERC
	French		German				
							
	10 AX 2P+E, shuttered + two-way, pin-earth		10 AX 2P+E, shuttered + two-way, side-earth				
Anthracite	MUR36025		MUR36024 MUR56024 ^(D)				
Characteristics	screwless switch: 10 AX-250 V AC IP55 - IK08		screwless switch: 10 AX-250 V AC IP55 - IK08				





^(D) Available in DIY Packaging

French socket-outlets					NF
	Single		Double	Triple	
					
	16 A 2P+E, shuttered, pin-earth		16 A 2P+E, shuttered, horizontal, pin-earth	16 A 2P+E, shuttered, horizontal, pin-earth	
White	MUR39030		MUR36027 ^(D)	MUR36039 ^(D)	
Anthracite	MUR35031		MUR36028	MUR36037 MUR86037 ^(D)	
Characteristics	IP55 - IK08 16 A 250 V AC screwless		prewired IP55 - IK08 16 A 250 V AC screwless	prewired IP55 - IK08 16 A 250 V AC screwless	



^(D) Available in DIY Packaging

Complete products

Surface mounting

German socket-outlets				EAC
	Single		Double	Triple
				
	16 A 2P+E, shuttered, screwless	16 A 2P+E, shuttered, screw terminals	16 A 2P+E, shuttered, screwless	16 A 2P+E, shuttered, screw terminals
White	MUR39034	MUR39206 MUR40011 ^(D) MUR89206 ^(D)	MUR39035 MUR40005 ^(D) MUR80005 ^(D) MUR89035 ^(D)	
Anthracite	MUR36034	MUR36731 MUR40012 ^(D) MUR86731 ^(D) MUR56034 ^(D)	MUR36029 MUR40006 ^(D) MUR56029 ^(D) MUR56129 ^(D) MUR80006 ^(D)	MUR36038 MUR86038 ^(D)
Characteristics	IP55 - IK08		prewired IP55 - IK08	prewired IP55 - IK08

^(D) Available in DIY Packaging

EV Socket-outlets		
	French	German
		
	16 A 2P+E, shuttered, pin-earth	16 A 2P+E, shuttered, side-earth
White	MUR39010	MUR39012
Anthracite	MUR36010	MUR36012
Characteristics	16 A 250 V AC IP55 - IK08	16 A 250 V AC IP55 - IK08

Complete products

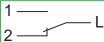

Flush mounting

Controls		CE	NF	EAC
	Single			
	Two-way with fixing claws			
White	MUR39721 MUR89721^(D)			
Characteristics	10 AX 250 V AC screwless IP55 (on flat/smooth walls only).			





^(D) Available in DIY Packaging

German Socket-outlets		EAC
		
	16 A 2P+E, shuttered, side-earth	
White	MUR39132 MUR40003^(D) MUR89132^(D)	
Anthracite	MUR36132 MUR86132^(D)	
Characteristics	16 A 250 V AC screwless IP55 - IK08	

^(D) Available in DIY Packaging

EV Socket-outlets		
	French	German
		
	16 A 2P+E, shuttered, pin-earth	16 A 2P+E, shuttered, side-earth
White	MUR39011^(D)	MUR39013^(D)
Anthracite	MUR36011^(D)	MUR36013^(D)
Characteristics	16 A 250 V AC IP55 - IK08	16 A 250 V AC IP55 - IK08

^(D) Available in DIY Packaging

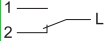
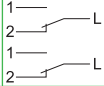
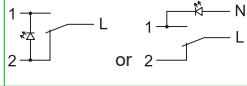
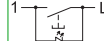
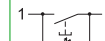
Controls						CE	NF	EAC
	Single	Double	With lamp	With lamp	With lamp and frame			
								
	Two-way	Double two-way	Two-way	Push-button	Push-button			
								
White	MUR40000^(D) MUR80000^(D)	MUR40001^(D)	MUR40017^(D)	MUR40021^(D)	MUR86628^(D)			
Anthracite	MUR40013^(D)	MUR40014^(D)						
Characteristics	10 AX 250 V AC IP55 - IK08							

^(D) Available in DIY Packaging

Technical information

Connection examples

Controls

Two-way switches

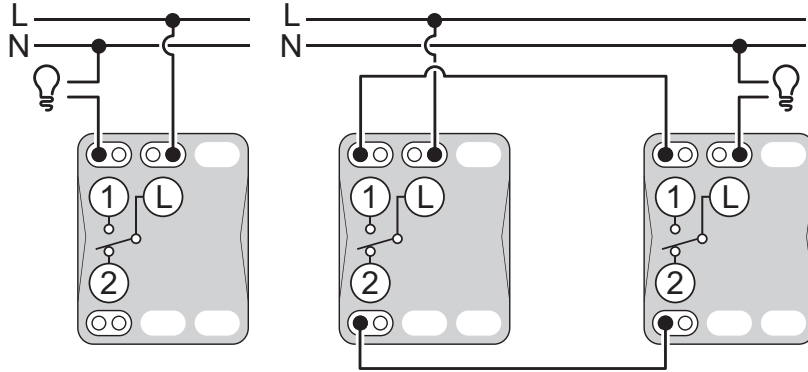

On/Off circuit

Two-way circuit

Two-way switches with LED

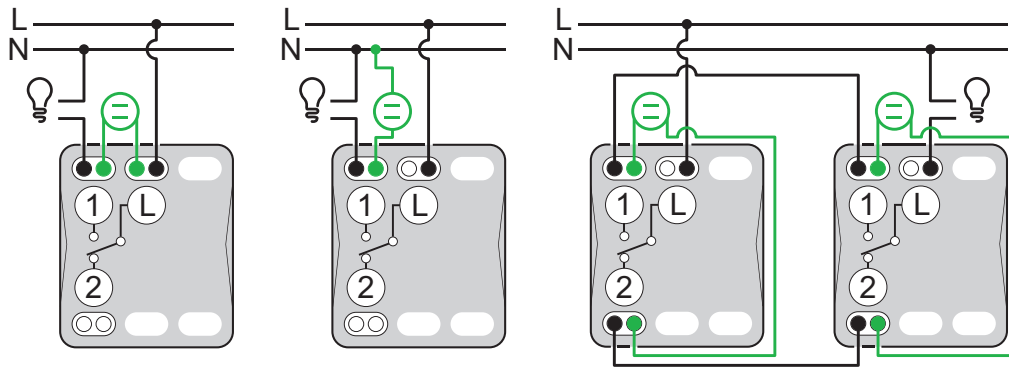

On/Off circuit with locator lamp

On/Off circuit with indicator lamp

Two-way circuit with locator lamp

Double two-way switches

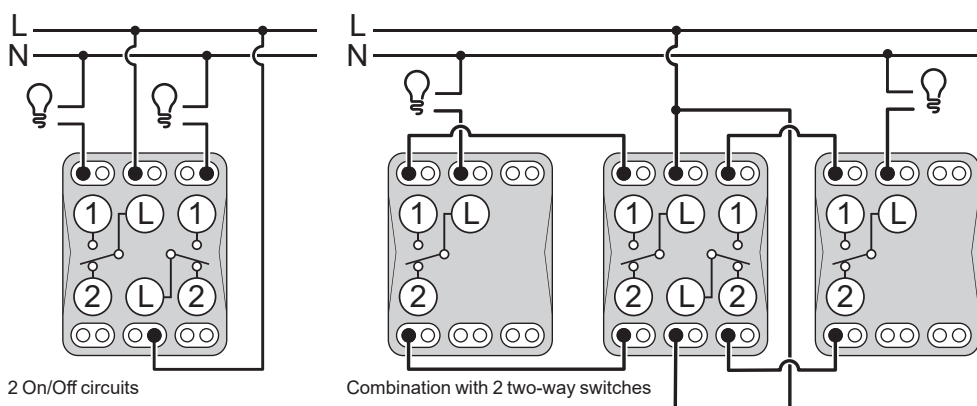

2 On/Off circuits

Combination with 2 two-way switches

Technical information

Connection examples

Push-button

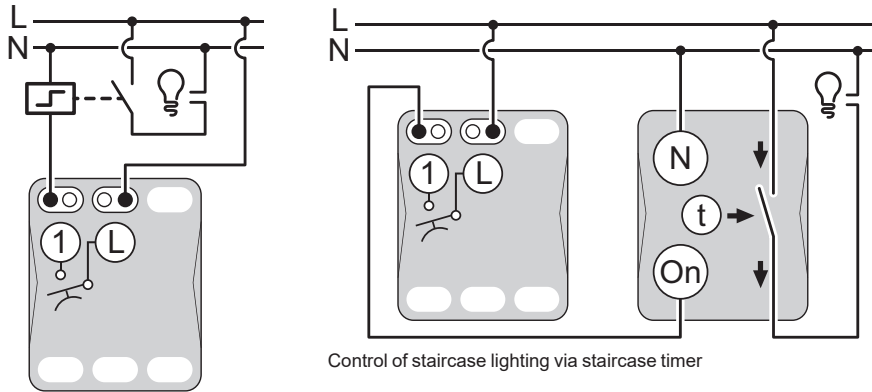

Control of light via impulse relay

Control of staircase lighting via staircase timer

Push-button with LED

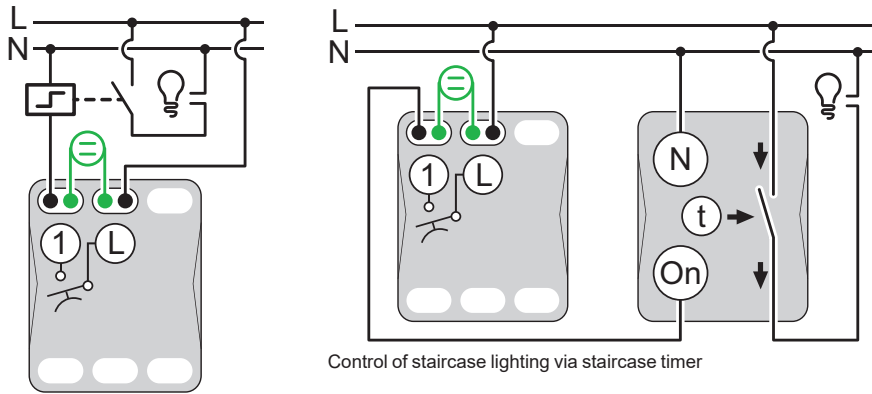

Control of light via impulse relay

Control of staircase lighting via staircase timer

Specialized controls

Roller blind push-button

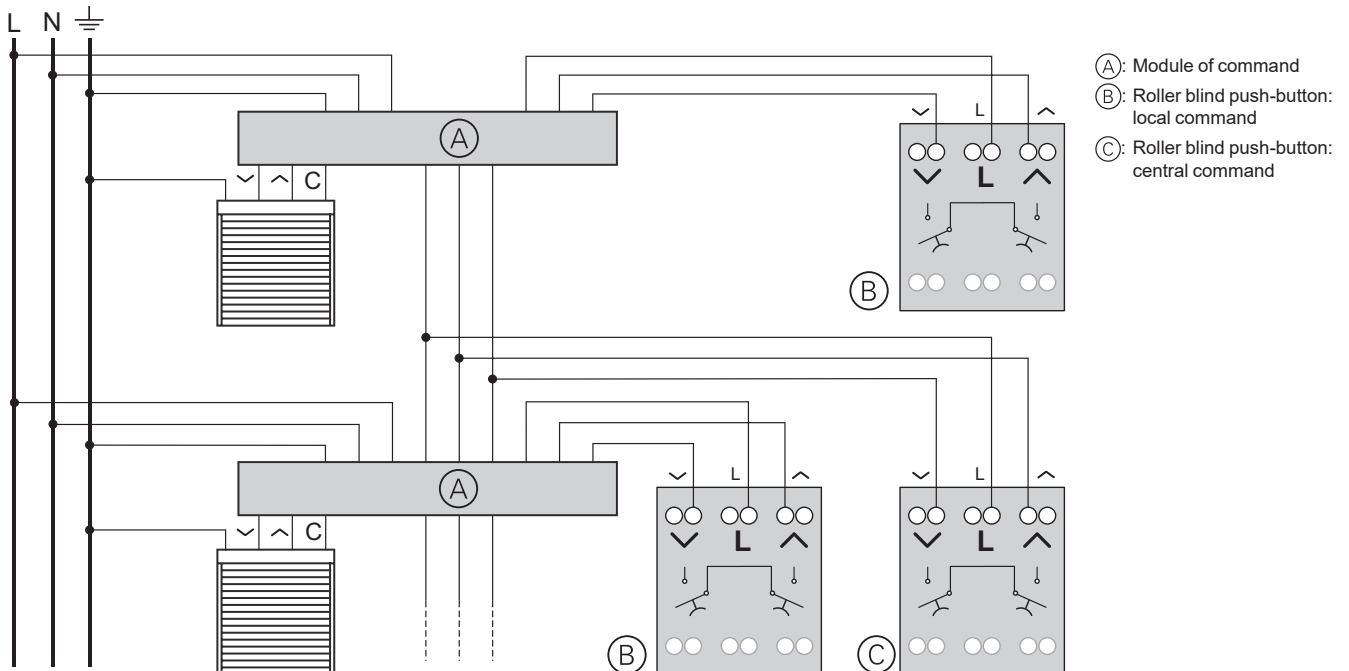

- (A): Module of command
- (B): Roller blind push-button: local command
- (C): Roller blind push-button: central command

Technical information

Lighting circuit equipment dimensioning and selection guide

- For english version; you can use the "http://download.schneider-electric.com/files?p_Doc_Ref=A9GT15E" link to download the "Lighting technical guide: How to control and protect lighting circuits?"
- For french version; you can use the "http://download.schneider-electric.com/files?p_Doc_Ref=A9GT15F" link to download the "Lighting technical guide: How to control and protect lighting circuits?"

Technical information

Dimensions

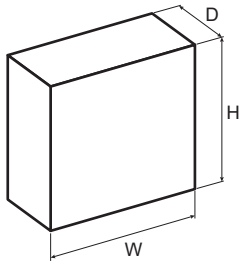

Ref.	Width (W)	Height (H)	Depth (D)
MUR34029	71	71	40
MUR34101	155	84	23
MUR34107	84	84	28
MUR34108	84	84	44
MUR34109	226	84	23
MUR34151	84	155	23
MUR34201	71	70	14
MUR34202	71	70	14
MUR34203	71	70	14
MUR34204	71	70	14
MUR34205	71	70	14
MUR35007	49	42	8
MUR35008	49	42	13
MUR35019	71	71	40
MUR35020	71	71	40
MUR35021	76	76	64
MUR35022	76	76	64
MUR35023	76	76	64
MUR35024	76	76	64
MUR35025	71	71	40
MUR35026	76	76	64
MUR35027	71	71	40
MUR35028	76	76	64
MUR35031	76	76	64
MUR35033	76	76	64
MUR35034	71	71	40
MUR35036	83	83	46
MUR35042	71	71	40
MUR35052	71	71	80
MUR35053	71	71	80
MUR35061	71	71	72
MUR35062	71	71	72
MUR35067	76	76	80
MUR35110	71	71	29
MUR35127	71	71	40
MUR35228	71	71	40
MUR35326	71	71	40
MUR36010	76	76	64
MUR36011	76	76	64
MUR36012	76	76	64
MUR36013	71	71	50
MUR36024	76	147	64
MUR36025	76	147	64
MUR36027	147	76	64
MUR36028	147	76	64
MUR36029	147	76	64
MUR36030	76	76	64
MUR36034	76	76	64
MUR36037	218	76	64
MUR36038	218	76	64
MUR36039	218	76	64
MUR36132	84	84	56
MUR36133	71	71	47
MUR36134	71	71	50
MUR36135	71	71	43
MUR36731	76	76	64
MUR37021	71	71	40
MUR37713	218	76	54
MUR37911	76	76	54
MUR37912	76	147	54
MUR37914	147	76	54
MUR37931	71	71	45
MUR37933	71	71	45
MUR38030	71	71	47
MUR39007	49	42	8
MUR39008	49	42	13
MUR39010	76	76	54
MUR39011	76	76	64
MUR39012	76	76	64
MUR39013	71	71	50
MUR39021	76	76	64
MUR39022	71	71	40
MUR39023	71	71	40
MUR39024	71	71	40

Ref.	Width (W)	Height (H)	Depth (D)
MUR39026	76	76	64
MUR39027	71	71	40
MUR39030	76	76	64
MUR39033	71	71	40
MUR39034	76	76	64
MUR39035	147	76	64
MUR39036	83	83	46
MUR39067	76	76	80
MUR39101	155	84	23
MUR39107	84	84	28
MUR39108	84	84	44
MUR39109	226	84	23
MUR39110	71	71	29
MUR39127	71	71	40
MUR39129	71	71	40
MUR39132	84	84	50
MUR39133	71	71	47
MUR39134	71	71	50
MUR39135	71	71	50
MUR39151	84	155	23
MUR39201	71	71	14
MUR39202	71	70	40
MUR39203	71	70	14
MUR39204	71	70	14
MUR39205	71	70	14
MUR39206	76	76	64
MUR39721	84	84	56
MUR39723	71	71	40
MUR39911	76	76	54
MUR39912	76	147	54
MUR39913	218	76	54
MUR39914	147	76	54
MUR40000	84	84	40
MUR40001	84	84	40
MUR40003	84	84	50
MUR40005	147	76	64
MUR40006	147	76	64
MUR40007	76	76	64
MUR40009	76	76	64
MUR40010	76	76	64
MUR40011	76	76	64
MUR40012	76	76	64
MUR40013	84	84	50
MUR40014	84	84	40
MUR40015	76	76	64
MUR40016	76	76	64
MUR40017	84	84	40
MUR40018	76	76	64
MUR40019	76	76	64
MUR40021	84	84	40
MUR55021	76	76	64
MUR55022	76	76	64
MUR55024	76	76	64
MUR55033	76	76	64
MUR56024	76	147	64
MUR56029	147	76	64
MUR56034	76	76	64
MUR56129	147	76	64
MUR80000	84	84	50
MUR80005	147	76	64
MUR80006	147	76	64
MUR85026	76	76	64
MUR86037	218	76	64
MUR86038	218	76	64
MUR86132	84	84	56
MUR86628	84	84	40
MUR86731	76	76	64
MUR89021	76	76	64
MUR89026	76	76	64
MUR89035	147	76	64
MUR89132	84	84	50
MUR89206	76	76	64
MUR89721	84	84	56

Reference number overview

Ref.	Page	Ref.	Page	Ref.	Page	Ref.	Page
MUR34004	14	MUR36028	16	MUR39151	15	MUR89035	17
MUR34029	13	MUR36029	17	MUR39201	14	MUR89132	18
MUR34101	15	MUR36030	16	MUR39202	14	MUR89206	17
MUR34107	15	MUR36034	17	MUR39203	14	MUR89721	18
MUR34108	15	MUR36037	16	MUR39204	14	S520291	14
MUR34109	15	MUR36038	17	MUR39205	14	S520292	14
MUR34151	15	MUR36039	16	MUR39206	17	S520293	14
MUR34201	14	MUR36132	18	MUR39721	18	S520299	14
MUR34202	14	MUR36133	13	MUR39723	13		
MUR34203	14	MUR36134	13	MUR39911	15		
MUR34204	14	MUR36135	13	MUR39912	15		
MUR34205	14	MUR36731	17	MUR39913	15		
MUR34206	14	MUR37021	13	MUR39914	15		
MUR34526	13	MUR37713	15	MUR40000	18		
MUR34555	14	MUR37911	15	MUR40001	18		
MUR34556	14	MUR37912	15	MUR40003	18		
MUR35007	14	MUR37914	15	MUR40005	17		
MUR35008	14	MUR37931	14	MUR40006	17		
MUR35019	13	MUR37933	14	MUR40007	16		
MUR35020	13	MUR38030	13	MUR40009	16		
MUR35021	16	MUR39007	14	MUR40010	16		
MUR35022	16	MUR39008	14	MUR40011	17		
MUR35023	16	MUR39010	17	MUR40012	17		
MUR35024	16	MUR39011	18	MUR40013	18		
MUR35025	13	MUR39012	17	MUR40014	18		
MUR35026	16	MUR39013	18	MUR40015	16		
MUR35027	13	MUR39021	16	MUR40016	16		
MUR35028	16	MUR39022	13	MUR40017	18		
MUR35031	16	MUR39023	13	MUR40018	16		
MUR35033	16	MUR39024	13	MUR40019	16		
MUR35034	13	MUR39026	16	MUR40021	18		
MUR35036	16	MUR39027	13	MUR55021	16		
MUR35042	13	MUR39030	16	MUR55022	16		
MUR35052	13	MUR39033	13	MUR55024	16		
MUR35053	13	MUR39034	17	MUR55033	16		
MUR35061	13	MUR39035	17	MUR56024	16		
MUR35062	13	MUR39036	16	MUR56029	17		
MUR35067	16	MUR39067	16	MUR56034	17		
MUR35070	13	MUR39070	13	MUR56129	17		
MUR35110	14	MUR39101	15	MUR80000	18		
MUR35127	13	MUR39107	15	MUR80005	17		
MUR35228	13	MUR39108	15	MUR80006	17		
MUR35326	13	MUR39109	15	MUR85026	16		
MUR36010	17	MUR39110	14	MUR86037	16		
MUR36011	18	MUR39127	13	MUR86038	17		
MUR36012	17	MUR39129	13	MUR86132	18		
MUR36013	18	MUR39132	18	MUR86628	18		
MUR36024	16	MUR39133	13	MUR86731	17		
MUR36025	16	MUR39134	13	MUR89021	16		
MUR36027	16	MUR39135	13	MUR89026	16		

Life Is On



Schneider Electric Industries SAS

35, rue Joseph Monier
CS 30323
92506 Rueil Malmaison Cedex
France

RCS Nanterre 954 503 439
Capital social 896 313 776 €
www.schneider-electric.com

09 2023
Mureva Styl catalogue

© 2023 - Schneider Electric. All Rights Reserved.
All trademarks are owned by Schneider Electric Industries SAS or its affiliated companies.
LSB03520EN

This document has been
printed on recycled paper

