

emergency

twenty-one



WHOLESALE





# emergency

wholesale  
twenty-one



## Index

### EMERGENCY

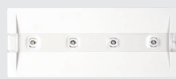
	<b>UpLED Lite</b>
IP65 - IP42	TR P. 4

	<b>Eurocompleta</b>
IP65 - IP42	TR P. 6

	<b>Aestetica</b>
IP40	TR P. 8

	<b>Stile+</b>
IP66 - IP40	TR P. 10

### EXIT SIGNE

	<b>UpLED Exit Lite</b>
IP40	TR P. 12



### CONDITIONS OF SALE

# UP LED Lite

emergency



- IP65
- IP42
- IK07
-  850°
- 
- Batt. LiFe  
 +40°C  
0°C

-  Compact design with only 2 cm thickness.
-  Rest mode input available. Signe screen not included (to be ordered separately) for signal exit light whit visibility from 20 m.
-  Optical system with 4 opal lenses for a more diffuse illumination.

## Applications

Industry, retail, hospitals, schools, offices, residential

## Characteristics

### Power supply voltage

230Vac ± 10%, 50Hz,

**Mounting** Wall, ceiling

**Recharging time** 12hrs

**Housing** Polycarbonate, white RAL 9003



**Optics** transparent Polycarbonate

**Screen** Clear polycarbonate

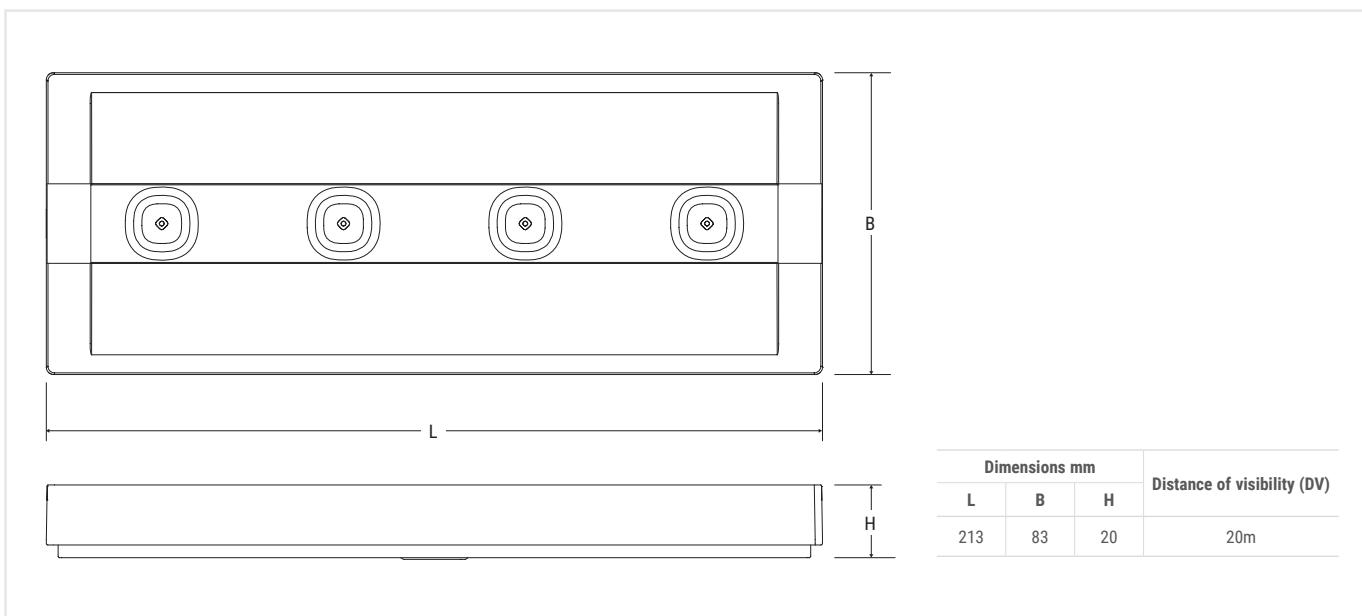
**Compliance** EN 60598-1, EN 60598-2-22, UNI EN 1838, EN 50172



## Performance according to EN 1838

Height (m) 	Centre distance (m) ESCAPE ROUTES 		Illuminated surface area (m) LARGE AREAS 	
	Wall	Ceiling	Wall	Ceiling
2.5	5,5	-	4x6	-
3	-	9	-	7x7
Lighting >1lx at floor level along the centre line without reflections Emax/Emin <40			Lighting >0.5lx at floor level without reflections Emax/Emin <40	
Performance with reference to luminaire Order Code 4341 200 lm			Maintenance coefficient 0.8	

## UP LED Lite

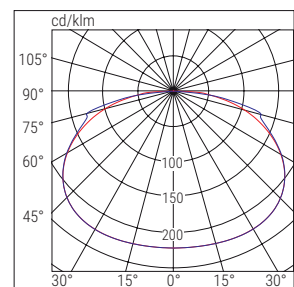

■ C0-C180 ■ C90-C270

	Order Code	Description	Version	Autonomy h	Battery	FLUX SE lm	FLUX SA lm	Input power		Weight Kg	Packaging Single/ Multi pack
								DC	AC		
TR	IP42										
	4353	UP LED LITE IP42 SE/SA RM LF	SA/SE	1/3	LiFe 3.2V 0.5Ah	200/100	-	2.3W	0.25	1/12	STANDARD
IP65											
	4354	UP LED LITE IP65 SE/SA RM LF	SA/SE	1/3	LiFe 3.2V 0.5Ah	200/100	-	2.3W	0.25	1/12	

## ACCESSORIES - included



## ACCESSORIES - to be ordered separately

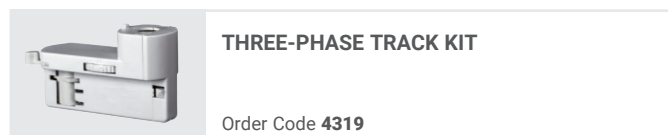
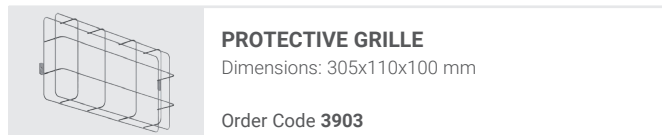
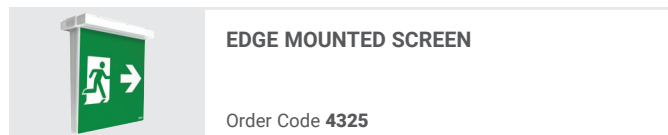
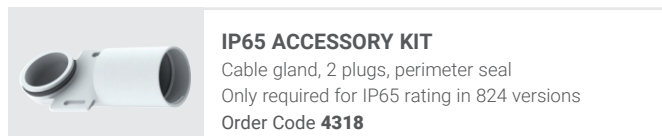
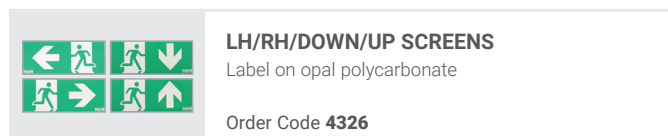

# Eurocompleta

emergency



IP65

IP42

IK08

850°



Batt. LiFe

+40°C  
0°C



IP65 luminaire particularly resistant to mechanical stress and weathering.



Innovative lens with RTI technology to increase mounting spacing. Signe stickers included for signal exit light with visibility from 24 m.



Housing equipped with many pre-drilled inlets, and accessories for  $\varnothing 16$  and  $\varnothing 20$ mm tube adapter and the IP Plug membranes supplied.

## Applications

Industry, hospitals, schools

## Characteristics

### Power supply

230Vac  $\pm$  10%, 50Hz

**Mounting:** Wall, ceiling, recessed, suspended ceiling, electrified track

**Recharging time** 12hrs

**Housing** Polycarbonate, white RAL 9003

**Optics** Symmetrical, white

**Screen** Transparent Polycarbonate

**Compliance** EN 60598-1, EN 60598-2-2, EN 60598-2-22, UNI EN 1838, UNI 11222

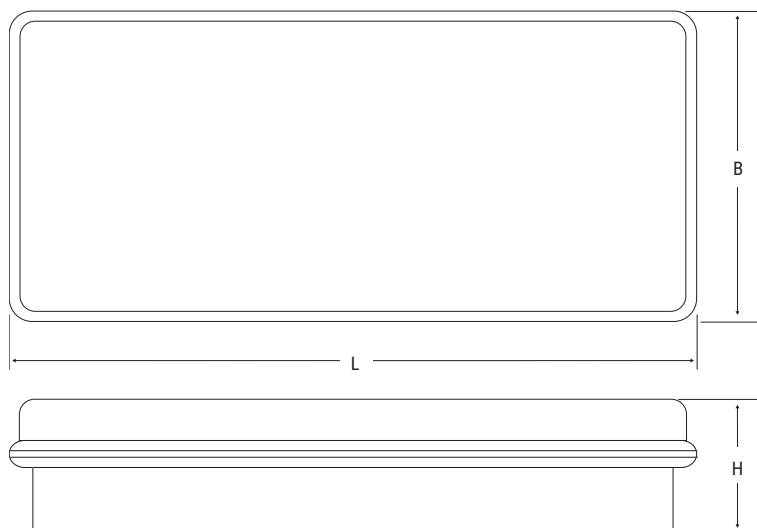

Dimensions mm			Distance of visibility (DV)
L	B	H	
300	138	55	24m

## Performance according to EN 1838

Height (m)	Centre distance (m) ESCAPE ROUTES		Illuminated surface area (m) LARGE AREAS	
	Wall	Ceiling	Wall	Ceiling
2.5	12	-	4x6	-
3	-	12	-	8x8
Lighting >1lx at floor level along the centre line without reflections Emax/Emin <40			Lighting >0.5lx at floor level without reflections Emax/Emin <40	
Performance with reference to luminaire <b>Order Code 4114</b> 350 lm			Maintenance coefficient 0.8	

## EUROCOMPLETA

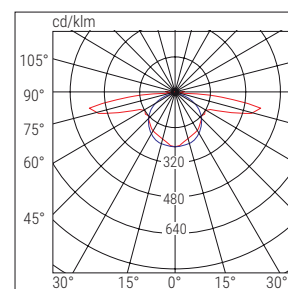

■ C90-C270

■ C0-C180

	Order Code	W eq.	Description	Version	Autonomy h	Battery	FLUX SE lm	FLUX SA lm	Input power		Weight Kg	Packaging Single/Multi pack
									DC	AC		
TR	<b>IP42</b>											
	4113	11	EUROCOMP LED IP42 SESA 1/3H LI-FE RM	SA/SE	1/3	LiFe 3.2V 0.5Ah	120/40	120		2.5W	0.8	1/12
	4114	24	EUROCOMP LED IP42 SESA 1/3H LI-FE RM	SA/SE	1/3	LiFe 3.2V 1.5Ah	350/70	200		4W	0.8	1/12
	<b>IP65</b>											
	4115	11	EUROCOMP LED IP65 SESA 1/3H LI-FE RM	SA/SE	1/3	LiFe 3.2V 0.5Ah	120/40	120		2.5W	1	1/12
	4116	24	EUROCOMP LED IP65 SESA 1/3H LI-FE RM	SA/SE	1/3	LiFe 3.2V 1.5Ah	350/70	200		4W	1	1/12

## ACCESSORIES - included



**LH/RH/DOWN/UP SIGN STICKERS**

Order Code **4117**



**CABLE CONDUIT GLAND PG16/PG20**

Removable for overhead mounting

Order Code **3727**

## ACCESSORIES - to be ordered separately



**SCREENS**

Order Code **4124** (LH/RH)

Order Code **4125** (DOWN)

Order Code **4126** (UP)



**RECESSED BOX**

Order Code **2742**



**SUSPENDED MOUNTING HOOKS**

Order Code **3723**

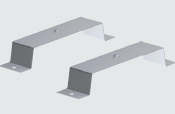

**FALSE CEILING BRACKET**

Order Code **2751**

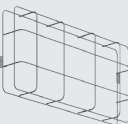

**PROTECTIVE GRILLE**

Dimensions 440x215x99 mm

Order Code **3912**

# Aestetica

emergency



Luminaire designed for recessed mounting.



The extensive range of accessories allows one luminaire to be used for recessed, edge mounting and plasterboard applications.



The housing is pre-fitted with several pre-drilled inlets to allow the entry of wire ways from all directions.

## Applications

Retail, restaurants, offices, schools, residential

## Characteristics

**Power supply** 230Vac  $\pm$  10%, 50Hz

**Mounting** Wall, ceiling, recessed, suspended ceiling, wall suspended

**Housing** Polycarbonate, white RAL 9003

**Optics** symmetrical, white

**Screen** Transparent Polycarbonate

**Compliance** EN 60598-1, EN 60598-2-2, EN 60598-2-22, UNI EN 1838, EN 50172

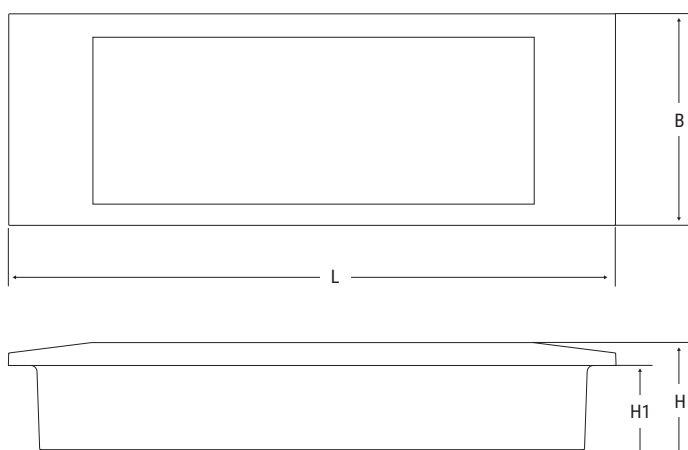

Dimensions mm				Distance of visibility (DV)
L	B	H	H1	
292	102	34,6	23	16m



## Performance according to EN 1838

Height (m)	Centre distance (m) ESCAPE ROUTES		Illuminated surface area (m) LARGE AREAS	
	Wall	Ceiling	Wall	Ceiling
2.5	5	-	3x3	-
3	-	7	-	5x5

Lighting >1lx at floor level along the centre line without reflections Emax/Emin <40

Lighting >0.5lx at floor level without reflections Emax/Emin <40

Performance with reference to luminaire **Order Code 16222** 140 lm

Maintenance coefficient 0.8

## AESTETICA

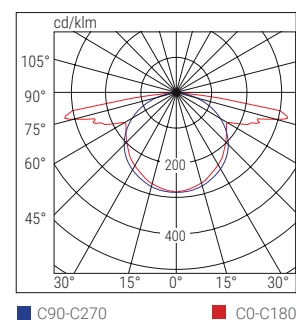

■ C90-C270 ■ C0-C180

	Order Code	W eq.	Description	Version	Autonomy h	Battery	FLUX SE lm	FLUX SA lm	Input power		Weight Kg	Packaging Single/Multi pack
									DC	AC		
TR	16220	6	AESTETICA LED 6W SE 1H IP40	SE	1	NIMH 3.6V 1.2Ah	70	-		0.8W	0.6	1/12
	16221	8	AESTETICA LED 8W SE 1H IP40	SE	1	NIMH 3.6V 1.2Ah	120	-		0.8W	0.6	1/12
	16222	11	AESTETICA LED 11W SE 1H IP40	SE	1	NIMH 3.6V 1.2Ah	140	-		0.8W	0.6	1/12
	16223	11	AESTETICA LED 11W SA 1H IP40	SA/SE	1	NIMH 3.6V 1.2Ah	140	90		0.8W	0.6	1/12
	16224	24	AESTETICA LED 24W SE 1H IP40	SE	1	2xNIMH 3.6V 1.2Ah	225	-		0.8W	0.6	1/12
	16225	8	AESTETICA LED 8W SE/SA 3H IP40	SA/SE	3	NIMH 3.6V 1.2Ah	105	70		1W	0.6	1/12
	16226	24	AESTETICA LED 24WSE/SA 3H IP40	SA/SE	3	2xNIMH 3.6V 1.2Ah	190	115		1W	0.6	1/12

## ACCESSORIES - to be ordered separately

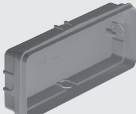

**RECESSED BOX**

Order Code **3733**

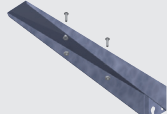

**WALL BRACKET X EDGE MOUNTING**

Order Code **4265**



**LH/RH/DOWN SIGN SCREENS**

Screen printing on opal polycarbonate

Order Code **4269**



**LH/RH EDGE MOUNTED SCREENS**

Screen printing on clear polycarbonate

Order Code **4267**

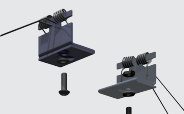

**FALSE CEILING BRACKET**

Order Code **4266**



**DOWN EDGE MOUNTED SCREEN**

Screen printing on clear polycarbonate

Order Code **4268**

# Stile+

emergency



- IP40
- IK05
- 850°
- 
- Batt. LiFe
- +40°C  
0°C

Luminaire suitable for both emergency lighting and signage, thanks to the Sign stickers not provided. Housing built to withstand outdoor use, equipped with LiFe battery and a 5-year warranty.

Unique luminaire with SE and SA function, with adjustable autonomy from 1 to 3hrs.

Large spaces inside the product facilitate wiring and maintenance. The housing is equipped with 3 x ø16 pre-drilled inlets and can be installed over a 503 box. Recessed box supplied.

## Applications

Services, commercial activities, shops, restaurants, offices

## Characteristics

**Power supply** 230Vac± 10%, 50Hz

**Mounting** Wall, ceiling, recessed, suspended, electrified track

**Recharging time** 12h

**Housing** Polycarbonate, white RAL 9003

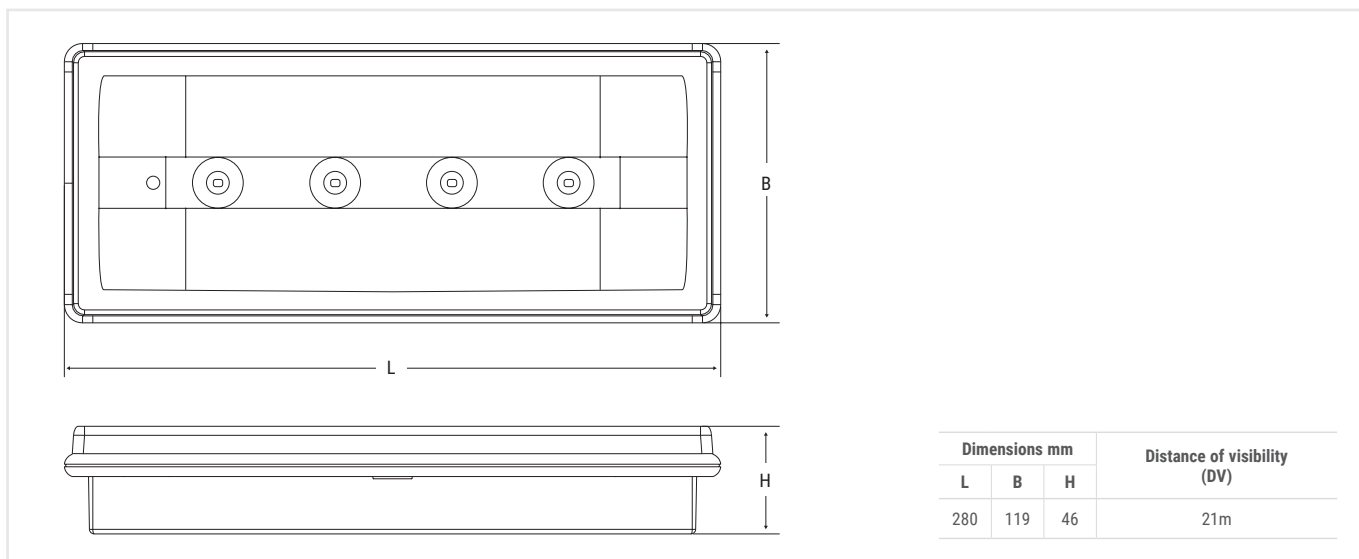

**Screen** Clear polycarbonate

**Compliance** EN 60598-1, EN 60598-2-2, EN 60598-2-22, UNI EN 1838, UNI 11222, EN 62034



Dimensions mm			Distance of visibility (DV)
L	B	H	
280	119	46	21m

## Performance according to EN 1838

Height (m) 	Centre distance (m) ESCAPE ROUTES 		Illuminated surface area (m) LARGE AREAS 	
	Wall	Ceiling	Wall	Ceiling
2.5	5	-	3x3	-
3	-	8	-	6x6
Lighting >1lx at floor level along the centre line without reflections Emax/Emin <40			Lighting >0.5lx at floor level without reflections Emax/Emin <40	
Performance with reference to luminaire <b>Order Code 19502</b> 120 lm			Maintenance coefficient 0.8	

## STILE+ RM

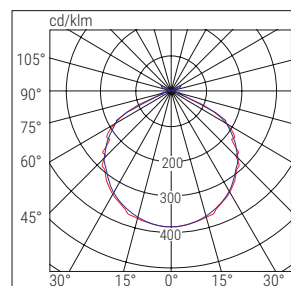

■ CO-C180

■ C90-C270

	Order Code	W eq.	Description	Version	Autonomy h	Battery	FLUX SE lm	FLUX SA lm	Input power		Weight Kg	Packaging Single/ Multi pack	STANDARD
									DC	AC			
TR	19502	11	STILE+ LED 11W SE/SA RM 1/3H	SA/SE	1/3	LiFe 3.2V 0.5Ah	120/50	110	0.8W	0.25	1/12	STANDARD	
	19503	18	STILE+ LED 18W SE/SA RM 1,5/3H	SA/SE	1.5/3	LiFe 3.2V 1.5Ah	250/150	110	0.8W	0.25	1/12		

## ACCESSORIES - included

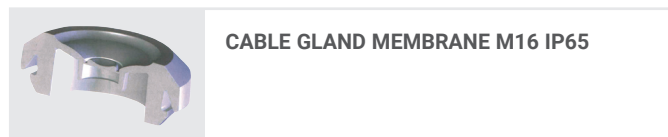

## ACCESSORIES - to be ordered separately

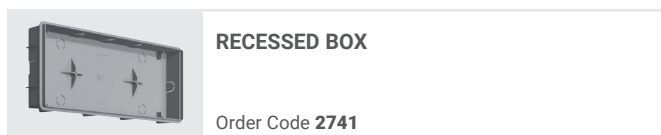
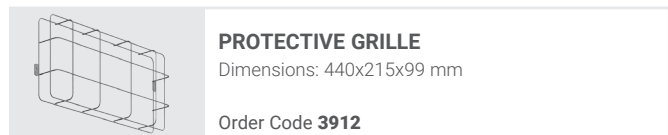
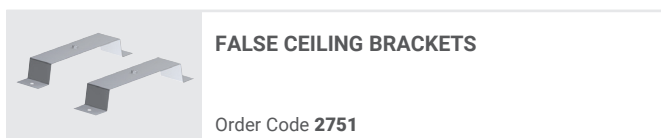
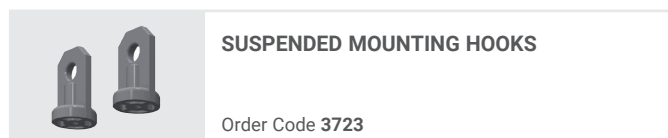
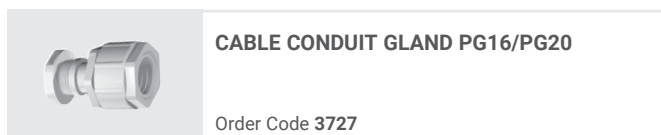

# UP LED Exit Lite

emergency



- IP40
- 850°
- IK05
- 
- Batt. NiCd
- +40°C  
0°C

- Signage suitable for any industrial or services installation. Available in two sizes with a distance of visibility (DV) of 20, 30 m.
- Screen-printed screen for more uniform signal illumination
- Innovative concealed fixing system. The same bracket, supplied, is used for both ceiling and edge mounting.

## Applications

Services, industry

## Characteristics

### Power supply

120Vac ± 10%, 60Hz

230Vac ± 10%, 50Hz

**Mounting** wall, suspended ceiling, ceiling with tiges, wall suspended, three-phase binary

**Housing** Polycarbonate, white RAL 9003

**Optics** high-efficiency back light system

**Screen** Clear polycarbonate

**Compliance** EN 60598-1, EN 60598-2-22, EN 60598-2-22, EN 1838, EN 50172, ISO 7010

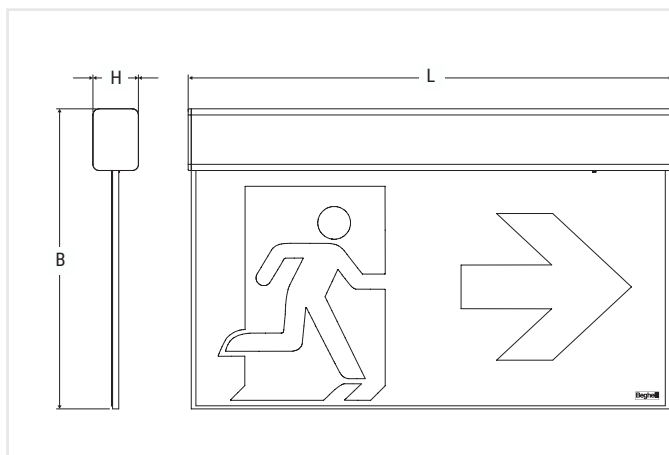

DV 20m

DV 30m

W	Dimensions mm			Distance of visibility (DV)
	L	B	H	
2	299	155	30	20m
3	329	205	30	30m

	Order Code	W	Description	Version	Autonomy h	Battery	Distance of visibility DV	Input power		Weight Kg	Packaging Single/ Multi pack	
								DC	AC			
TR	4350	2	UP LED EXIT 20M SA RM 1h	SA	1	NiCd 3.6V 0.75Ah	20m		2.5W	0.3	1/6	STANDARD
	4351	3	UP LED EXIT 30M SA RM 1h	SA	1	NiMh 3.6V 1.2Ah	30m		3.5W	0.5	1/6	

### ACCESSORIES - included



**LH/RH/DOWN SCREENS**  
Screen printing on opal polycarbonate



**UNIVERSAL BRACKET**

### ACCESSORIES - to be ordered separately



**CEILING RECESSED MOUNTING ACCESSORY**  
Distance of visibility (DV) 20-30 m  
Order Code **4312** (20 m) - **4313** (30 m)



**SUSPENDED MOUNTING ACCESSORY WITH CABLES**  
Order Code **14771**



**THREE-PHASE TRACK KIT**  
Order Code **4319**

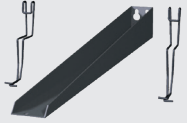

**EDGE MOUNTING WALL BRACKET**  
60m versions only  
Order Code **19045**



**SUSPENDED MOUNTING RODS**  
250 - 500 - 1000 mm  
Order Code **4315** (250 mm) - **4316** (500 mm)  
**4317** (1000 mm)

# General terms and conditions of sale

## 1. ORDERS - FINALISATION OF AGREEMENTS

Product purchase orders shall be formulated in writing. Order placement is deemed irrevocable. All collaboration programs, orders, work orders and agreements are considered finalised by the written or verbal confirmation of the Seller or, however, as soon as the invoicing and/or delivery of the ordered products is initiated.

## 2. VARIANTS AND MODIFICATIONS

After order finalisation, any modification or addition to the content and conditions of the order shall be valid and will become effective only after the Buyer receives a confirmation variant from the Seller. The text of the Seller's confirmation or confirmation variant shall in all cases prevail over any other document. If the Buyer does not intend to accept the conditions that differ from his/her order, he/she must inform the Seller within 20 (twenty) days from the date of confirmation; otherwise, the confirmation variant will be considered fully accepted.

## 3. METHOD OF ACCEPTANCE

The Seller shall not be held liable for any unaccepted orders or for any failed or delayed delivery of the products part thereof. Acceptance and execution of the order are specifically subject to the availability of the products ordered as well as the absence of circumstances that may affect the availability of the same and the timeliness of their delivery.

## 4. TERMS OF DELIVERY

The delivery terms communicated by the Seller are purely indicative. Delivery terms expressed in days are normally counted in working days. Any changes to the delivery terms requested by the Buyer must be first accepted in writing by the Seller. Any delay in deliveries, as well as any interruption and/or total or partial suspension of supplies, even if not due to force majeure and/or accidental circumstances, will not entitle the Buyer to compensation for damages and/or to any other kind of indemnity or interest, except for the sole right to cancel the order, provided that the Seller is notified in advance, with at least thirty days before the day of receipt of the registered letter with acknowledgement of receipt sent by the Buyer.

## 5. FORCE MAJEURE

By way of example, but not limited to, the following are considered cases of force majeure: strikes, lockouts, riots, labour conflicts, fires, natural disasters, impossibility of supplying products, interruptions or difficulties in transport, delays of shipment, lack of raw materials, government acts, authority measures, contractual non-fulfilment by suppliers and, in general, any unforeseeable event that is outside the reasonable control of the Seller. In all such cases, as well as in the event of any accidental circumstances, the Seller reserves the right to suspend and/or delay the delivery of the products and even cancel the orders, even if already confirmed; this will not entitle the Buyer to compensation for damages and/or to any other kind of indemnity, including those for direct, indirect and consequential loss.

## 6. DELIVERY - TRANSPORT

The goods always travel at the risk and danger of the Buyer, even if delivered carriage paid and/or using a vehicle of the Seller; therefore, the Seller will not accept disputes for any product breakage and/or tampering. The delivery of the products is intended to be carried out at the Seller's headquarters in Monteveglio - Valsamoggia (Bologna) or at third party warehouses with which the Seller has entered into special agreements ("Ex works" condition - Incoterms 2010). Transport costs are borne by the Buyer. The Seller does not accept returns.

## 7. COMPLAINTS - PRODUCT REPLACEMENT

Any requests for replacement and complaints shall be handled by applying the safeguards provided by the applicable legislation in relation to the specific type of customer, professional operator or consumer. Upon product receipt, the Buyer must check its condition, the quantity delivered and its compliance with the delivery note. Any complaints concerning product quality, quantity or type shall be submitted in writing within 8 (eight) days from the date of receipt of the goods. After this period, without prejudice to the warranty conditions provided for the individual products, no claim can be made regarding the material and quality of the goods, or their condition in general. The Buyer may not, under any circumstances, return the products without the prior written authorisation of the Seller, nor delay and/or suspend the payment of invoices in whole or in part, not even in the case of complaints. If, in the opinion of the Seller, the claim is justified and has been filed within the warranty terms stated in the booklets accompanying the individual products, the obligation of the latter is limited only to the replacement of the nonconforming product in accordance with the delivery terms established for the first delivery. It is, therefore, excluded any right of the Buyer to cancel the order or to obtain any compensation for expenses and/or damages. The right to replace the contested product shall lapse if the product is not diligently stored, kept at the disposal of the Seller, and returned immediately to the place determined by the Seller.

## 8. APPLICATION OF WARRANTY

The warranty applies only to faults and/or defects in the conformity of the product in relation to the terms and conditions indicated in the declared and/or agreed technical specifications or in case of premature breakage of one of its parts. The validity period of the aforementioned warranty is at least 24 months from the date of purchase, which can be proved by presenting a valid tax document. Luminaires with extended warranties are marked in catalogues or instruction sheets with the number of years of total warranty in conjunction with the letter G (e.g., 5G marking for products with a 5-year warranty). As a general rule, the following extensions apply: emergency luminaires equipped with Lithium Iron batteries (LiFe) and centralised emergency lighting systems benefit from a 5-year warranty, those equipped with Lithium Titanate batteries (LTO) benefit from a 10-year warranty (for all parts, including batteries); EcoDriver or Dimmable luminaires benefit from a 3-year warranty, SmartDriver luminaires benefit from a 5-year warranty (for all parts, including sources). The warranty does not apply in case of tampering, to defects caused by accidental damage of any kind, including during transport and installation, in case of improper use or use in disagreement with the product specifications, in case of negligence in use and maintenance, errors in installation or connection, and installation performed by unqualified personnel or without respecting the state-of-the-art standards. Unless otherwise required by applicable law, the warranty is limited only to the replacement/repair of nonconforming products or parts, according to the delivery terms of the first delivery. All work performed under warranty by the Seller shall be subject to observance of the payment conditions by the Buyer.

## 9. PRICES

The prices indicated in the Seller's price lists are not binding; therefore, the Seller reserves the right to modify them until the time of delivery of the products. All prices are exclusive of VAT and any other tax charges.

## 10. PAYMENTS

All payments shall be made, within the terms and in the manner indicated by the Seller, to its headquarters in Monteveglio - Valsamoggia (Bologna) or to the appointed person authorised in writing by the Seller. In case of delay in payment, the defaulting buyer will be obliged to pay the Seller interests on late payment from the date of expiry of the contractual period until settlement, to the extent provided for in Legislative Decree 231/2002, apart from any compensation for any further damages incurred. Failure to comply with the payment terms by the Buyer will give the Seller the right to terminate the corresponding supply contract with immediate effect and to suspend the delivery of all products ordered without the need for any communication, with the consequent right of the Seller to demand the immediate payment of the entire credit as well as to claim compensation for the damages incurred. In case of non-fulfilment and/or worsening of the patrimonial conditions of the Buyer to a degree that may jeopardise the collection of the credit by the Seller, as well as in the event of prolonged delay in payments and/or high total debt exposure (also due to previous uncollected sales), the Seller reserves the right to apply the provisions of art. 1460 and 1461 CC, undertake appropriate precautionary actions and resort to any other form of self-protection permitted; it is further agreed that in such cases the Seller may suspend any and all supplies.

## 11. LIEN AGREEMENT

The products sold are subject to a lien agreement; therefore, the Seller will retain possession of the goods sold until their price is paid in full. The Buyer, therefore, undertakes to inform third parties of the existence and effectiveness of this Lien Agreement, as well as to safeguard the Seller's rights deriving from the same.

## 12. SAFEGUARDING – DISPUTES AND JURISDICTION

The invalidity or unenforceability of any of the clauses contained in these general conditions of sale shall not affect, or detract from the validity and enforceability of the other provisions; the Seller and the Buyer undertake to replace any clauses declared ineffective and/or null, or impracticable, with other provisions having similar effects. For any dispute or contestation relating to the interpretation, validity and execution of the order or, in any case, concerning the contracts to which these general conditions of sale apply shall be governed by the Italian Law. The Forum of Bologna shall have exclusive jurisdiction.

# Product safety and European Directives

## PRODUCT SAFETY AND EUROPEAN DIRECTIVES

Beghelli products are manufactured according to the state-of-the-art standards concerning safety and quality and will not affect, even when used under foreseeable overload conditions, the safety of persons, pets and property, on condition that they are correctly installed and used according to their intended purpose in the recommended environmental conditions and subject to proper maintenance by qualified personnel.

To the extent applicable, the products shall be manufactured in accordance with the requirements of Community Directives 2014/35/EU, 2014/30/EU, 2014/53/EU, 2014/30/EU, 2009/125/CE, 2001/65/CE.

The CE marking affixed to the product and/or packaging and/or any warnings of use accompanying the product attest to the conformity of the product with the aforementioned Directives. Beghelli has its own Technical Archive, available to the competent authorities for possible inspections, containing documentation demonstrating that the product has been examined to assess its compliance.

Products that do not fall within the scope of the above-mentioned EC Directives comply with the quality standards laid down by the regulations in force and by Directive 2001/95/CE ("General Product Safety Directive"), transposed by Legislative Decree No. 172/2004.

The data contained in this catalogue may be subject to change without notice.

The indications, dimensions, drawings and photos of the products and components are given for informational purposes only and may be modified without prior notice, as they do not constitute pre-contractual information. All products intended to be connected to the mains shall be installed in compliance with the installation standards in force in the country of use, observing the information contained in the Catalogue and/or the relevant instructions supplied with the product itself.

# Environmental protection

## WEEE DIRECTIVE 2012/19/EU

The quantities of waste from electrical and electronic equipment (WEEE) are rapidly increasing; most of the light sources are included in this category.

The main aim of the directive is to prevent WEEE from being discarded to landfills or incinerators at the end of their life, thereby causing further serious environmental impact. Directive 2012/19/EU, therefore, sought to induce a control mechanism which provides for a controlled end-of-life management of the device by giving priority to its reuse or recycling. In addition, the legislative mechanism promotes design and production concepts that make it easier to dispose of the products in terms of both their disassembly and their materials.

All supply chain participants are invited to make their own contribution, some with regard to the economic aspects, some in terms of activity, so that the spirit of the directive is respected (and the environment is protected).

In Italy, the Directive has been transposed by Legislative Decree No. 49 of 14 March 2014.

## THESE ARE THE MAIN OBLIGATIONS FORESEEN

The manufacturer (understood in a broad sense and, therefore, essentially as the person who affixes one's own brand on the goods and who imports them from third countries) is responsible for the costs of disposing of their products at the end of their life.

The consumer is required to guarantee an intelligent end-of-life management of the product by sending it to a specially equipped site, a point of sale or by observing the instructions provided by the manufacturer.

Beghelli, always sensitive to environmental issues, is one of the founding members of the ECOLIGHT consortium.

Choosing products from companies that have joined voluntary consortia for the recovery and recycling of goods is the responsible and ecologically correct choice to protect the environment and our future.

Products falling under the scope of the WEEE Directive are identified by this symbol.



## ROHS DIRECTIVE 2011/65/UE

In order to facilitate the recovery and recycling of electrical equipment and to prevent hazardous substances from accumulating into the environment, the European Community has enacted the ROHS Directive. Essentially, this Directive states that:

Without prejudice to Annex 3, the placing on the market of new electrical and electronic equipment falling within the categories identified in Annex 1 containing lead, mercury, cadmium, hexavalent chromium, polybrominated biphenyls (PBB) or polybrominated diphenyl ether (PBDE) in excess of the value indicated in Annex 2, shall be prohibited.

In Italy, the Directive has been transposed by Legislative Decree No. 27 of 4 March 2014.

**ECOLIGHT**



Dealer  
IMQ mark



Partner **DIALUX**

Associate:



*Assil*



The technical data and images in this catalogue are subject to continuous development and may change without notice. To check the latest technical update of the luminaires, please refer to the electronic catalogue on [www.beghelli.com](http://www.beghelli.com).

Digital catalogues of the various product ranges are also available on the website and can also be requested in hard copy from:  
**BEGHELLI S.p.A. - Commercial Division - Via Mozzeghine, 13/15  
Valsamoggia Loc. Monteveglio - 40053 BO**

© Copyright 09/2021

**Beghelli**

BEGHELLI S.p.A. Via Mozzeghine 13/15 - 40053 Valsamoggia loc. Monteveglio  
Bologna - Italy - Tel. +39 051 9660411 - [info@beghelli.it](mailto:info@beghelli.it) - [www.beghelli.com](http://www.beghelli.com)

**Beghelli**