

**Pioneering Products, Solutions and Services**  
Your Partner in Smart Industrial Connectivity



**Weidmüller** 



# **A Global Player** from East Westphalia-Lippe

We are where our customers are







# Technologies help overcome hurdles

## We create access

Be it automobile manufacturing, electricity production or water management – hardly any of today's industries can do without electronics and electrical connectivity. And in this internationalised world characterized by technological change, the associated requirements are rapidly becoming more complex due to the emergence of new markets. New, more varied challenges have to be overcome, and the solutions to them will not be found in high-tech products alone. Connectivity is the key, whether it involves power, signals and data, demands and solutions or theory and practice. Industrial Connectivity needs connections. And that is precisely what we stand for.

### Shaping the digital transformation together

As pioneers of Industrial Connectivity, we are taking the next logical step into digitalisation – both in our own production and in the development of products, solutions and services for Smart Industrial Connectivity and the Industrial Internet of Things. In partnership, we support our customers in the digital transformation, the distribution of power, signals and data and the development of new business models.



### Chapter

- 01**      **Connectivity**  
Page 6
- 02**      **Electronics**  
Page 14
- 03**      **Automation & Software**  
Page 20
- 04**      **Workplace & Accessories**  
Page 26
- 05**      **Assembly**  
Page 32
- 06**      **Customised solutions**  
Page 36
- 07**      **Service & Support**  
Page 42







# Our markets

## As individual as our customers

Our customers' markets are our home. With passion and comprehensive know-how, we develop innovative solutions for our customers' challenges, whether in the automotive industry, in transport, in conventional power generation or in the field of renewable energies.

Together with our customers and partners, we meet the challenges of the various industries with cutting-edge and innovative solution concepts from a single source that go with the trend of digital transformation.

### Machine & Factory Automation

 Consumer Goods & Packaging	 Automotive & Suppliers
 Elevators & Escalators	 Intralogistics

### Energy

 Wind	 Photovoltaics
 Hydrogen	 Transmission & Distribution

### Transport

 Railway	 Marine
 e-mobility	 Infrastructure





### Process

 Water treatment	 Oil & Gas
 Chemical & Pharmaceuticals	 Glass

### Building Infrastructure

 Office buildings	 Industrial buildings
 Commercial buildings	 Official buildings













### Device Manufacturers





 Robotics	 Control devices
 Telecommunications devices	 Power electronics

# From the panel via the device to the field

## Our products and solutions at a glance

**Panel IP20**

<b>POWER</b>						
	Terminal blocks	Power supplies	Lightning and surge protection	Measuring and monitoring systems		
	<b>SIGNAL</b>					
		Terminal blocks	PLC interfaces and migration solutions	Analogue signal conditioning	Relay modules & Solid-state relays	
<b>DATA</b>						
		Sensors	Controls	I/O Systems	Touch-Panels	Industrial Ethernet

<b>WORKPLACE</b>				
	fully-automated machines	semi-automated machines	Tools	Printers



## Device



PCB terminals and connectors



PCB terminals and connectors



PCB jacks

## Field > IP20 ... IP69K



Heavy duty connectors

Distribution boxes

Contactless connectivity

PV Combiner Boxes



Enclosure Systems



Cable entry systems

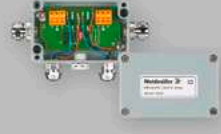

Fieldbus distributors



Service interfaces



Cord sets, patchcords and cables



IP67 I/O-Systems



EV charger

## Software & Cloud



Industrial Analytics & IIoT-Services



Engineering and Visualisation tools



Weidmüller Configurator



Markers



Cable ducts



Industry lights



Marking software



# Connectivity

Well thought-out connections increase your efficiency

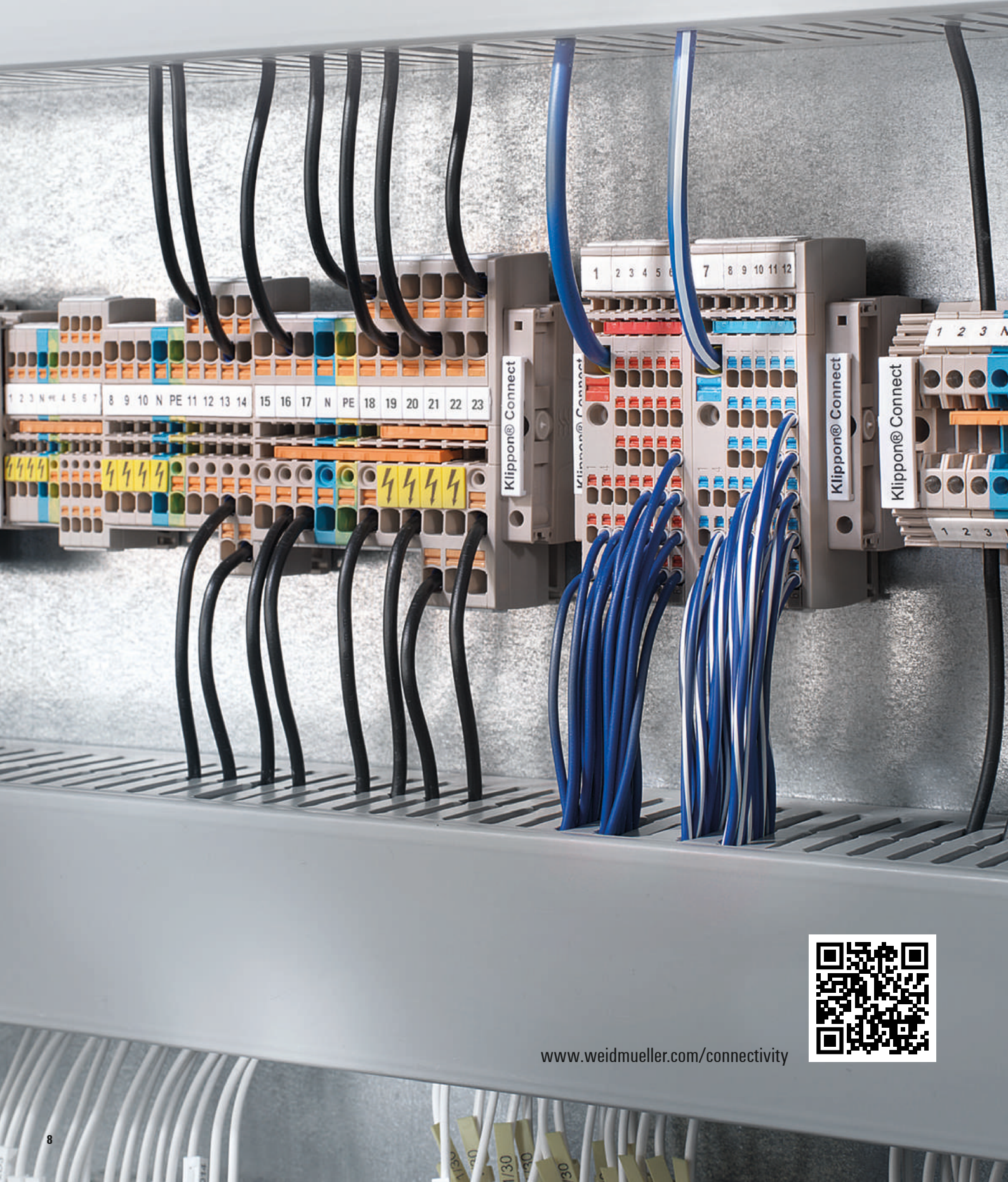

[www.weidmueller.com/connectivity](http://www.weidmueller.com/connectivity)





## The pioneering connectivity solution

### Klippon® Connect terminal blocks

Whether it is easy handling, more space in the control cabinet or time savings during installation: Klippon® Connect ensures you numerous advantages throughout the entire panel building process.

#### Application range

There are applications in the control cabinet that are an integral part of almost any area of use. We have closely examined them to make your work easier for you. The result: our innovative Klippon® Connect application products.

#### Universal range

With the Klippon® Connect universal range, we offer you a complete range of standard products with all common connection systems and functions.

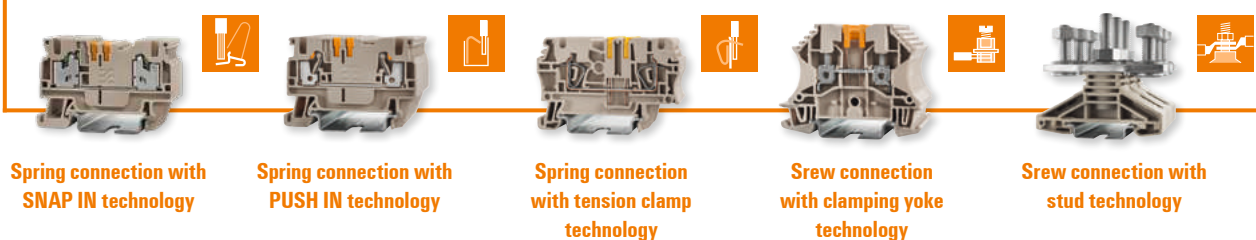
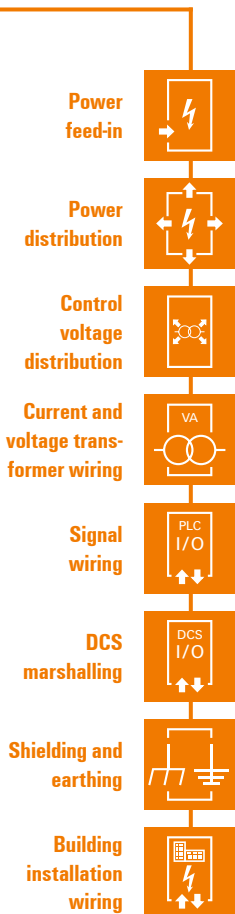



## Connection solutions for the transmission of power, signals and data

### Connectors

Whether it is circular connectors for signal processing between the sensor and the controller or heavy-duty IP67 connectors for power transmission at the carriage transition of high-speed trains – Weidmüller offers suitable connection solutions for the transmission of power, signals and data between the field level and the control cabinet.

Our range is also complemented by our customised assembly services. In this way, we help to manage even the most complex cabling projects with ease and are the best partner for implementing complete connection solutions – from individual connectors to cabling concepts and smart solutions for the systems of the future.

#### Your benefits at a glance:

- All relevant connectors for industrial applications
- Developed, tested and manufactured for the highest requirements
- Requirements of worldwide standards 100 % fulfilled





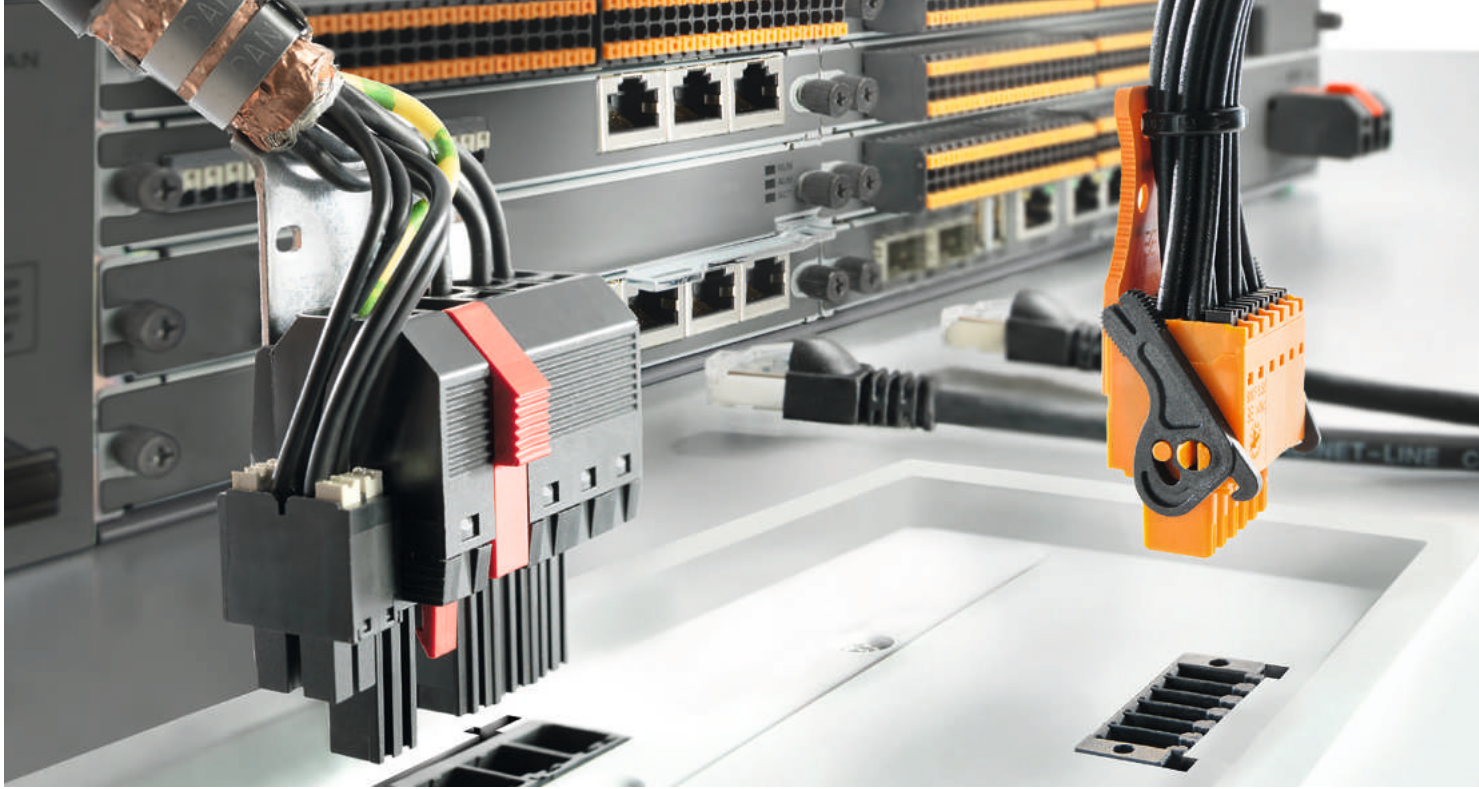

## Tailor-made connections across the board

### OMNIMATE® device connectivity

Device designs are smaller, more powerful and more cost-effective with each new generation. Accordingly, the connection system for more compact sizes must transfer high currents to the printed circuit board reliably and with minimum losses. At the same time, a mechanically stable connection must be ensured.

Put your trust in the original in PCB connection technology with OMNIMATE® – we offer you the right products and services for your device design.

#### Your benefits at a glance:

- Cutting-edge connection solutions for data, signals and power
- Global 72-hour sample service
- Product configurations for individual solutions with just a few clicks of the mouse
- Support for each step of your design-in process

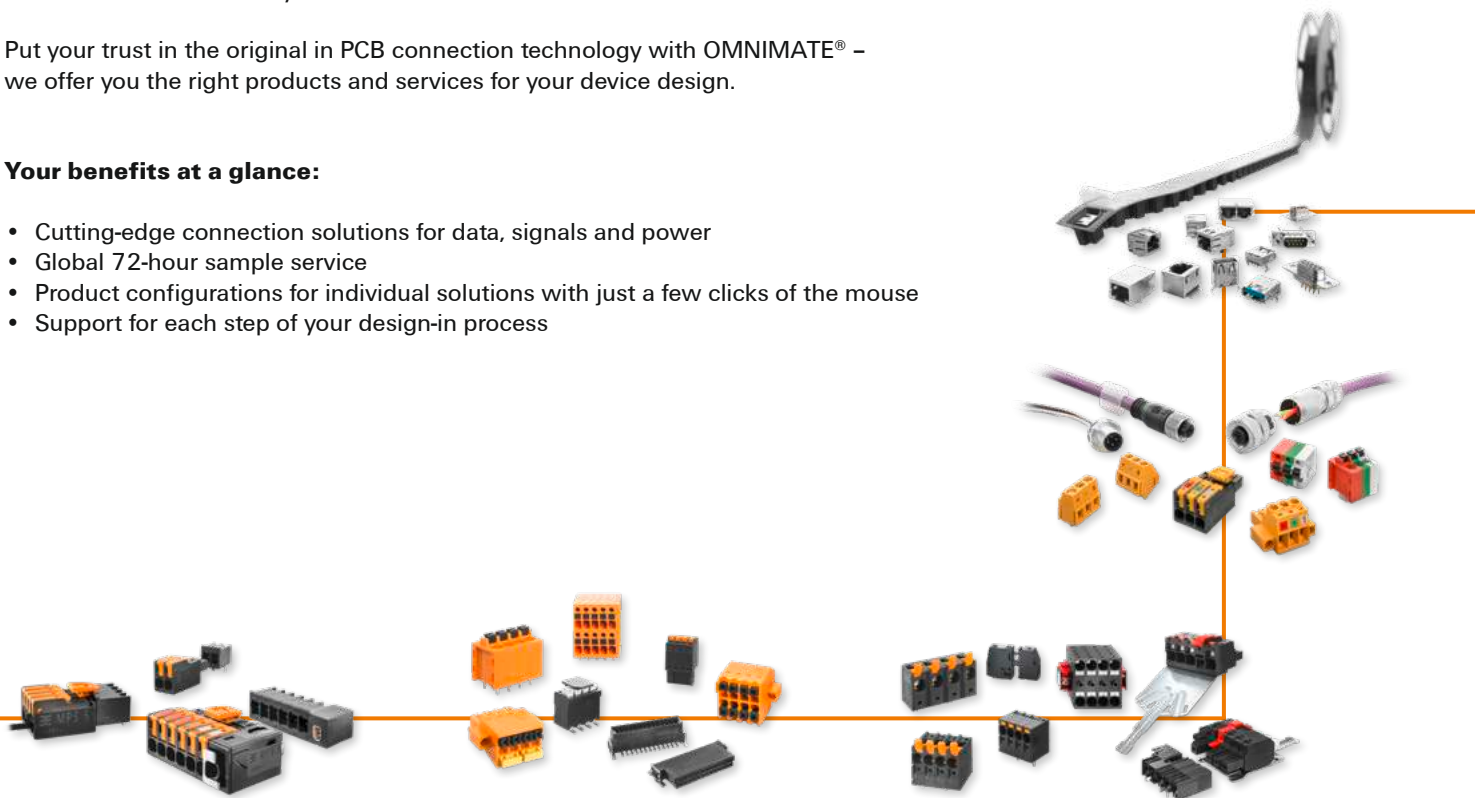

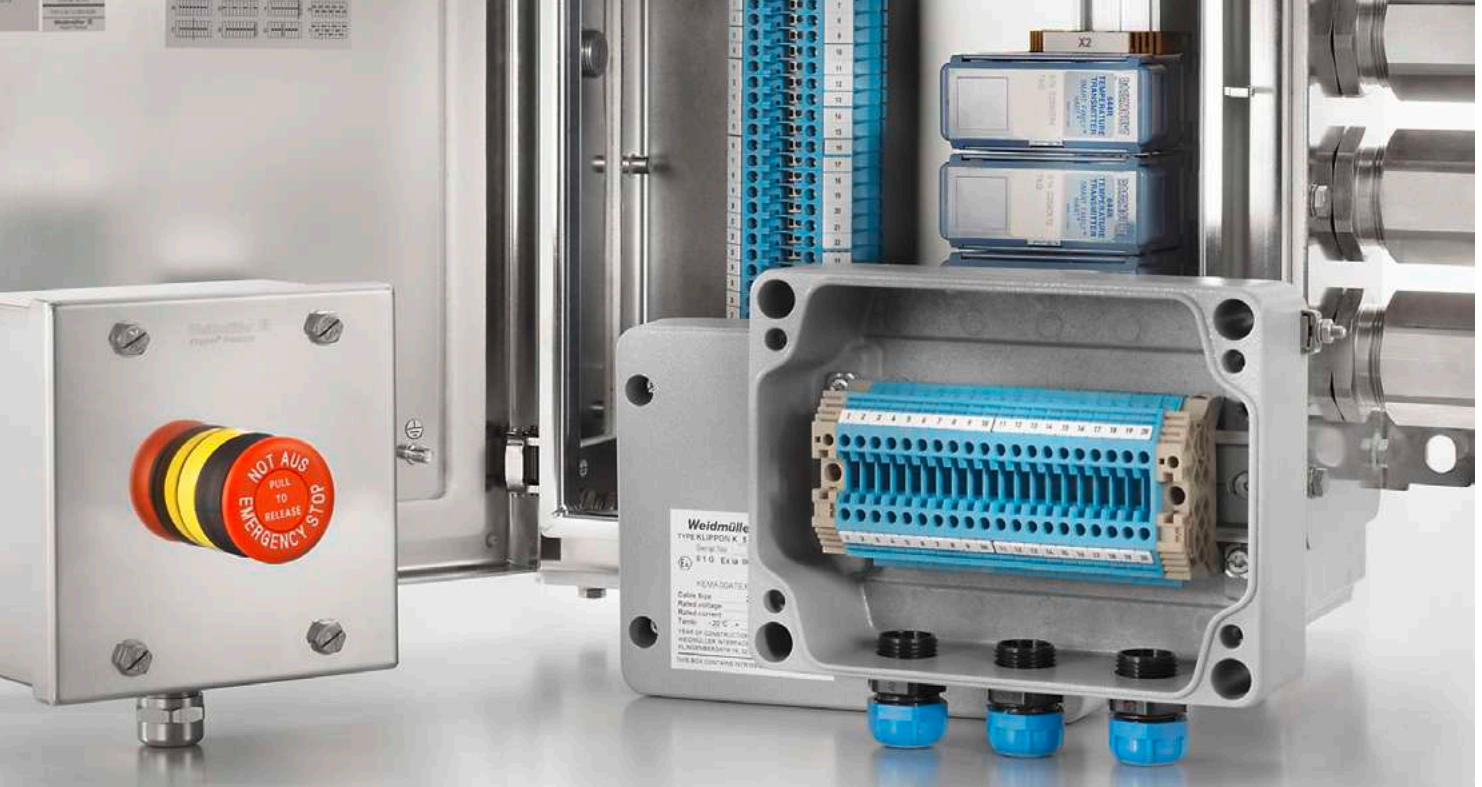

## Secure protection for your components Klippon® Protect enclosure systems

Enclosures fulfil an important safety function and prove their worth every day, even under the toughest conditions. Every industry has its own specific requirements for enclosure technology. At the same time, the enclosures must meet the strict requirements of the international approvals.

Our Klippon® Protect enclosure system has all the approvals required for use in industrial and explosive risk zones. In addition, it can be optimally adapted to your needs. We round off our range with individual services to provide you with the best possible support for your processes.

### Your benefits at a glance:

- Innovative enclosure concepts for outstanding performance
- Robust and safe enclosures for the highest protection requirements
- Comprehensive range of service

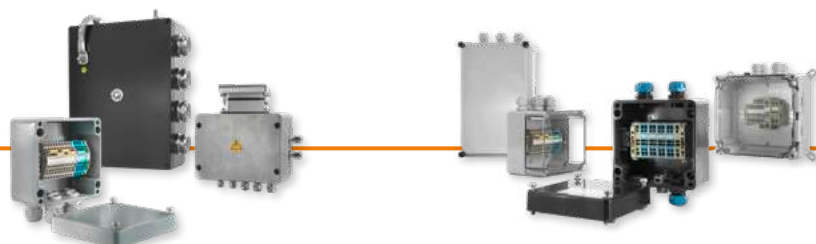





## Reliable and contactless energy transmission

### FreeCon contactless

Thanks to inductive resonance coupling, FreeCon Contactless enables reliable and contactless power transmission of up to 240 W with compact dimensions and maximum efficiency. Contact-related failures can be avoided and maintenance costs significantly reduced.

The process of charging driverless transport systems, for instance, can consequently be automated. With this multitude of advantages, it helps to increase the level of automation and optimises the production process.

#### Your benefits at a glance:

- High power density with maximum efficiency
- High flexibility thanks to unlimited approach options
- PROFINET PushPull power connection

## Simple, fast and safe cable entry

### Cable glands & Cabtite

We offer a variety of add-on components for a multitude of applications in addition to its wide range of enclosures. These include standard cable glands made of brass, plastic and stainless steel for industrial applications and hazardous areas.

Another alternative is our modular cable entry system Cabtite, which saves you time, space and costs while offering you maximum flexibility.

#### Your benefits at a glance:

- High IP ingress protection class with IP66
- Integrated strain relief
- Installation safety through acoustic feedback
- Quick adaptation of cable management

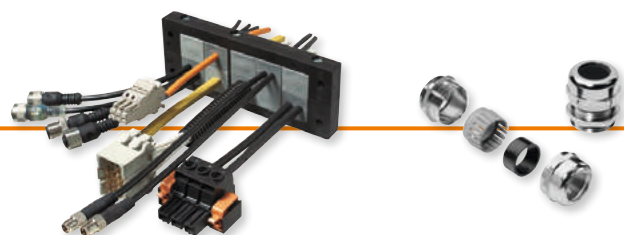

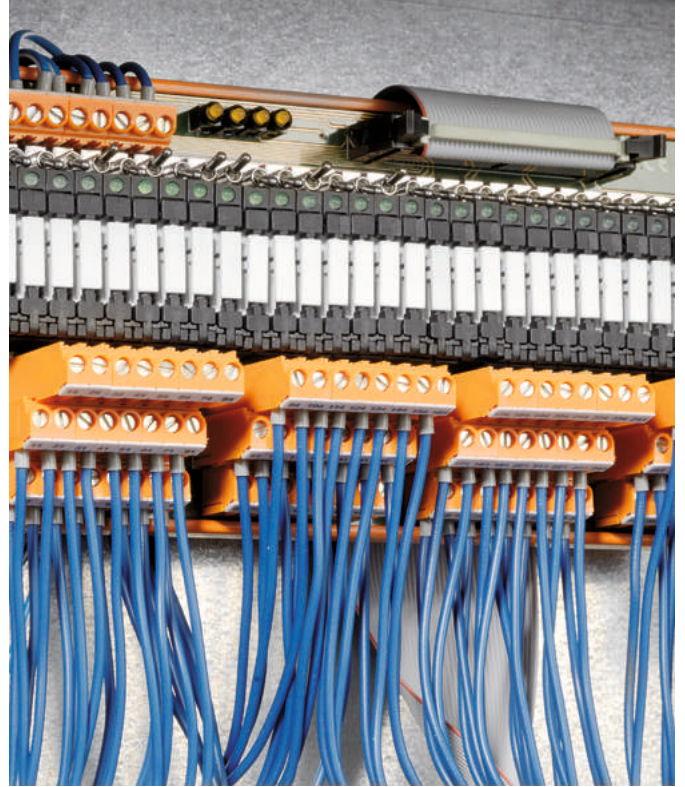

## Plug-and-produce solutions

### Connection lines, patch cables and cables

Through continual modularisation and decentralisation, the need is growing for standardised plug-and-produce solutions that are efficient to both install and operate.

Choose from our extensive range of pre-assembled cables, or use our online configurator to create customised signal or data cables.

#### Your benefits at a glance:

- Customised solutions from batch size 1
- Suitable for use in robots and with recyclable, halogen-free cables
- Online configurator for customised variants

## Fast exchange of PLC systems

### PLC / DCS System Cabling & Migration Solutions

The increasing complexity of machines and plants makes wiring between controls, sensors and actuators a real challenge.

As an alternative to traditional individual wiring, interface modules and ready-to-connect multi-core cables offer considerable savings potential.

#### Your benefits at a glance:

- Efficient exchange without downtime
- Suitable for all common control systems
- Compact design saves space in the control cabinet
- Time savings of up to 95 %

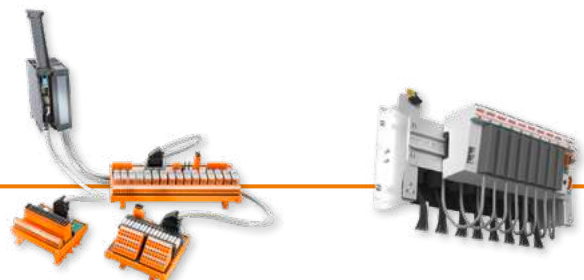





## Simple access to the inside of the control cabinet

### FrontCom® Vario

Attaching protected service interfaces to the housing walls of your panels is a simple, well-proven solution used to effectively boost your system's availability and productivity.

You can then grant your technicians quick and safe access to the control elements and functional electronics in the control cabinet at any time – without having to open it.

#### Your benefits at a glance:

- Many functions, one single frame – space-saving
- 5,000 possible combinations for increased flexibility
- Fast reading of product data



## The modular base for decentralised automation

### Distribution Boxes

Modern automation solutions are becoming increasingly decentralised. Accordingly, there is a need for components that can be easily integrated into the automation systems commonly available on the market and whose connection is more efficient than time-consuming individual wiring.

Flexible distribution boxes enable reliable, decentralised signal and power transmission with a protection class of up to IP67 – wherever you need the distribution boxes.

#### Your benefits at a glance:

- Modular decentralisation in all areas
- Protection class up to IP67
- Certified for worldwide use



# Electronics

Reliable, safe and innovative solutions



[www.weidmueller.com/electronics](http://www.weidmueller.com/electronics)





## Reliable and durable relay modules and solid-state relays

Switch to simple – with Klippon® Relay modules

Optimising the control cabinet infrastructure is our daily motivation. Whether switching, isolating, amplifying or multiplying: relays perform a wide range of different tasks in industrial applications.

They have very specific properties and there is an almost unmanageable variety of them available on the market. Our Klippon® Relay portfolio convinces with reliable, safe and resilient products.

### Your benefits at a glance:

- Maximum relay variety, matching accessories and service
- High-quality, well-designed products
- Comprehensive support for the right product selection
- Space-saving thanks to compact, slim design types
- Robustness and cost efficiency in all application environments

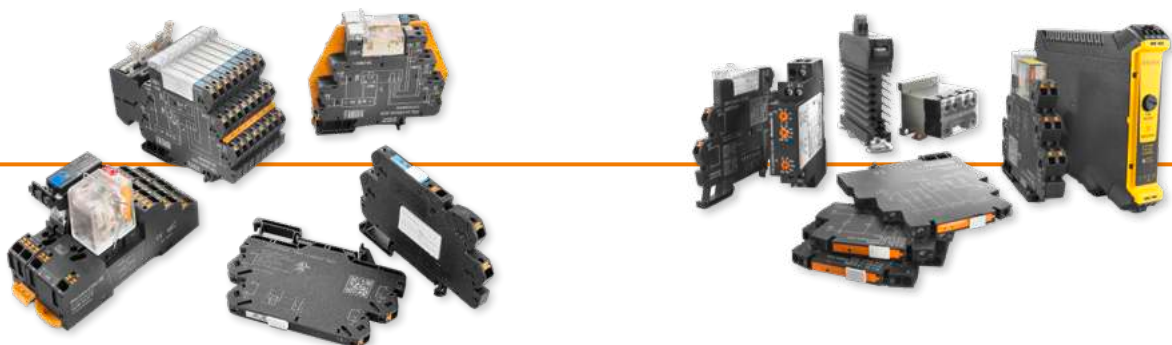



## Convert, isolate, monitor and visualise digital and analogue signal values

### ACT20 series

Considering the increasing automation, isolating amplifiers are required, which convert, isolate, monitor, protect and visualise your digital and analogue signal values from industrial and process automation, e.g. temperature, pressure, level, flow volumes, weight and speed.

Our signal converters for DC standard signals, isolation amplifiers for 4 to 20 mA and 0 to 10 V, switching amplifiers, frequency converters and threshold switches are characterised by high level of accuracy, universality and a wide assortment of variants.

#### Your benefits at a glance:

- Protecting, converting and isolating signals reliably and precisely
- Narrow as well as flat design – suitable for all applications
- Quick and easy configuration







## Secure power in automation

### Power supply

Our power supply products can be used universally in conjunction with our Industrial Ethernet, lightning and surge protection, relays and semiconductor switches, and can be combined to form many solutions.

#### Your benefits at a glance:

- Modular: three performance classes and various accessories
- Tailor-made solutions for every application
- More reliable systems and prevention of production downtimes
- DCL technology, IO-Link module with integrated ORing MOSFET

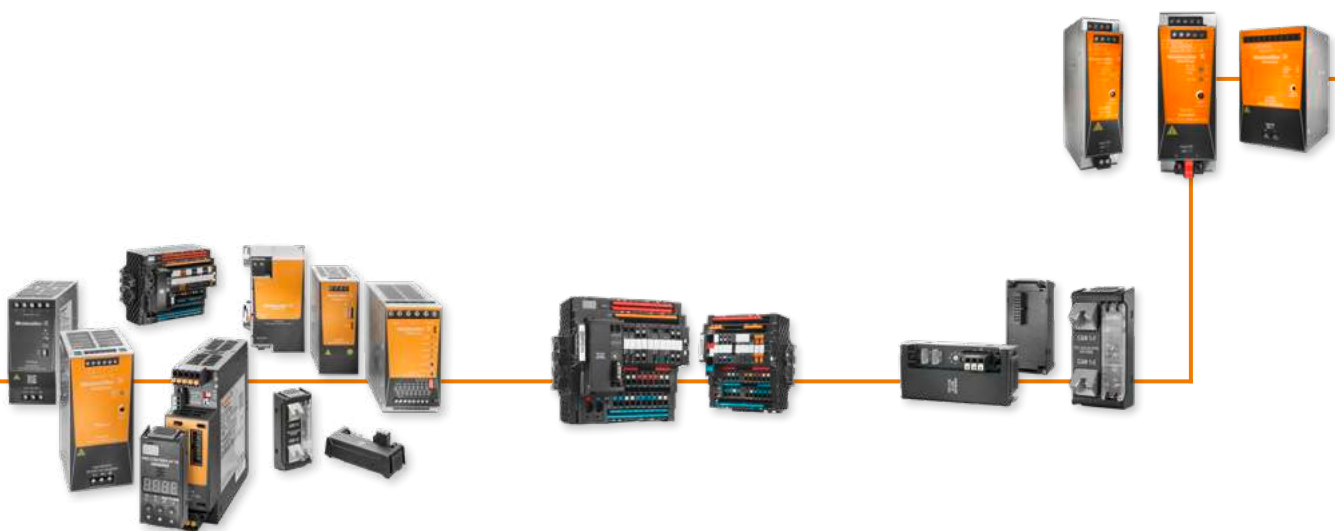

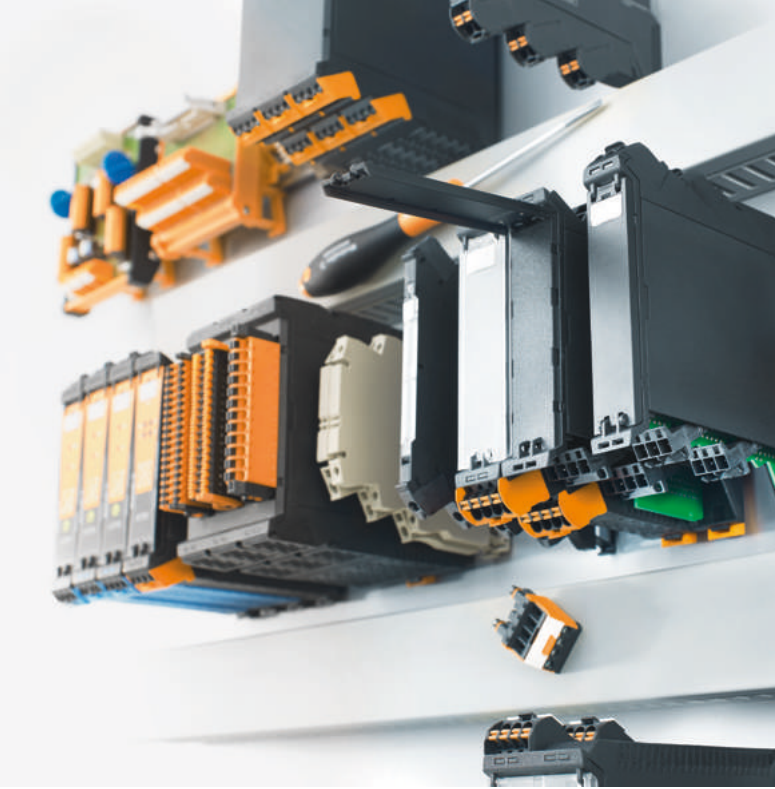

## Electronics safely packaged Tailored enclosure systems

From standard to customised mass production – with our enclosure systems, we offer you solutions that are perfectly suited for the installation of industrial electronic components in control cabinets. These form a future-proof platform for your applications in the fields of control, signal conversion and machine safety.

### Your benefits at a glance:

- Modular concepts for maximum design freedom
- Highest packing density and easy handling
- Cost and time savings over the life cycle

## Connection of intelligent field devices to your fieldbus segments FBCon fieldbus distributors

With our FBCon fieldbus distributors, you connect devices in the field to fieldbus segments for PROFIBUS PA, Foundation Fieldbus H1, PROFIBUS DP and Modbus RS485 in protection class IP66.

Our FBCon fieldbus distributors have EMC cable glands with high shield attenuation and are available in an aluminium or stainless-steel version as well as ATEX variants for potentially explosive atmospheres. FBCon with integrated current limiting protect the bus communication in case of a short circuit of the unit in the field.

### Your benefits at a glance:

- Broad operating temperature range from -40 °C to +80 °C
- Flexible installation in the field
- Versatile fieldbus connection options

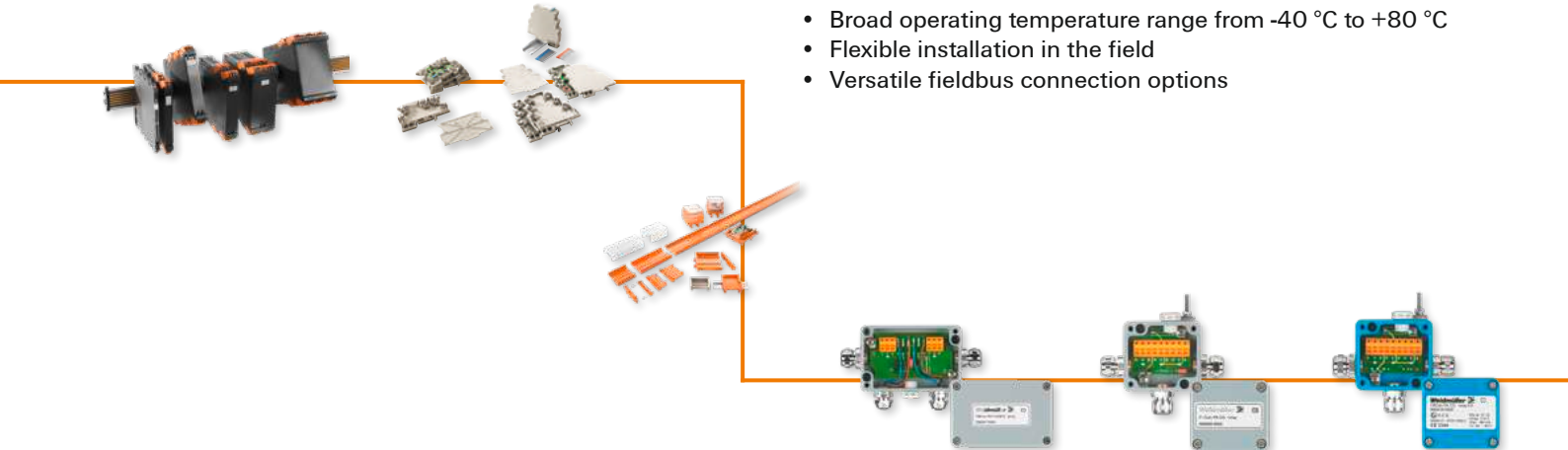



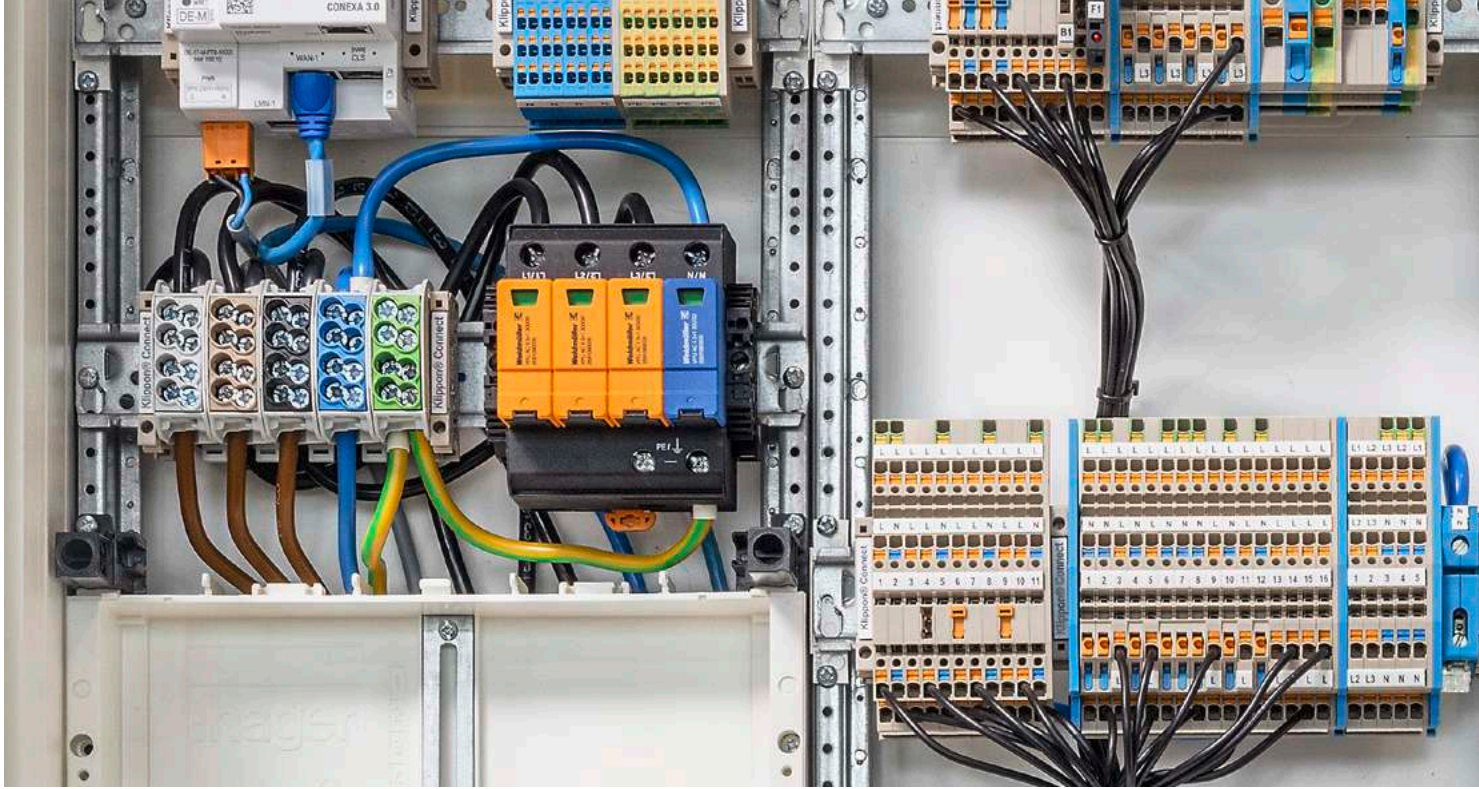

## Reliable protection for your plants, devices, machines and energy grids

### VARITECTOR lightning and surge protection

Industrial plants and building infrastructures are becoming increasingly complex. This makes them more sensitive to surge damage.

In addition, digitalisation is increasing the number of connections and data streams that must not be interrupted. Reliable lightning and surge protection ensures system availability, protects against data loss, and increases added value.

#### Your benefits at a glance:

- Protecting your investment, your processes and your data
- Reliable and well-thought-out products and solutions
- Compliance with all required norms and international standards





# Automation & Software

u-mation. More than Automation. IIoT Solutions.



[www.weidmueller.com/automation\\_software](http://www.weidmueller.com/automation_software)





## Master increasing complexity systematically

### u-control and u-OS

Implement small, large, and networked control solutions flexibly with high-performance, modular controller hardware.

With u-control and the matching engineering environment from our u-mation portfolio, we provide you with a flexible control solution for automation or digitalisation. Choose your new operating system u-OS for Industrial IoT and Automation.

#### Your u-control benefits at a glance:

- Compact with a width of only 54 mm
- Compatible with most of the u-remote portfolio
- "Securitybydesign" concept and continuous testing





## Reliability in the transmission of signals and data

### I/O system u-remote

Our I/O system u-remote offers the perfect solution for all common fields of application in mechanical and plant engineering.

Whether as a pure control cabinet system, in mixed IP20 and IP67 applications or even positioned directly in the field for signal connection – u-remote grants you all the freedom you need for a flexible I/O architecture and gives you with the advantages of an integrated complete system.

#### Your benefits at a glance:

- Flexible system design and cabling
- Absolutely reliable in the transmission of signals and data
- Real-time data transmission

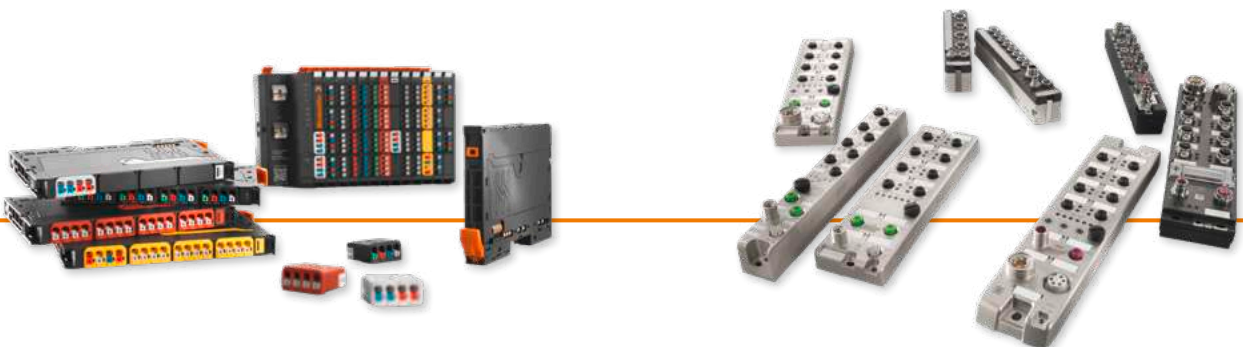





## Powerful visualisation of HMI applications

### u-view panel monitors

The Industrial IoT is not only changing process flows; it is also constantly increasing the demands on analysis, maintenance and operation options.

Our u-view touch panels are available in basic and advanced versions. The web-based and scalable software u-create PROCON-WEB gives you control over the entire process chain.

#### Your benefits at a glance:

- Robust aluminium housing with IP66 protection class
- First-class image quality and powerful processors
- Operation via modern touch technology

## Visualisation, control and IoT applications

### u-view industrial PCs

Powerful IPCs and panel PCs enable flexible control, operation and monitoring of machines and systems.

They are characterised by high reliability and are tailored to the most modern visualisation, control and IoT applications.

#### Your benefits at a glance:

- Different performance classes
- Robust aluminium housings
- Suitable for use in robots and with recyclable, halogen-free cables
- Support of Windows and Linux operating systems



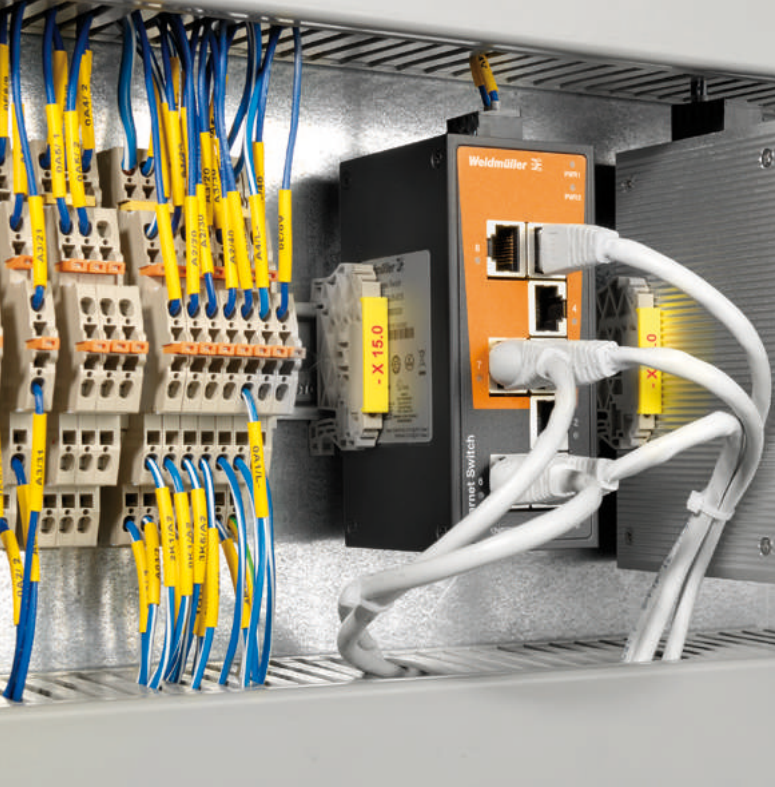

## Industrial data transmission with network devices

### Industrial Ethernet

As a full-range supplier of industrial network infrastructures for plant and machine construction, we have a wide range of switches for the specific requirements of our customers – from Gigabit switches, media converters, Power-over-Ethernet switches, WLAN devices to serial/Ethernet converters.

We always have you firmly in mind and pursue the goal of meeting the highest demands and enabling reliable as well as flexible Ethernet communication.

#### Your benefits at a glance:

- Ensuring uninterrupted network operation
- PROFINET Class B, EtherNet/IP and CC-Link
- High resistance

## Remote access made easy

### u-link

u-link guarantees quick and secure access to machines and plants, while also allowing forefficient management of manufacturing plants, user clients, access rights or firmware versions. The u-link interface can be configured without expert knowledge and adapted to processes.

Safeguarded servers in Europe also provide an online platform that ensures conformity between different IT systems for remote maintenance.

#### Your benefits at a glance:

- Connect your machine with just one click
- Secure remote access
- Open device topology and data export
- Clear dashboards







## Use Machine Learning without prior knowledge of Data Science

### Industrial AutoML

As a machine or process expert, you can easily build and run machine learning models quickly and easily without prior knowledge in data science.

The AutoML tool empowers you to transfer your data and domain knowledge into ML (Machine Learning) models that generate value to your business. The models can be used in existing manufacturing environments to provide production workers and stakeholders in your operation with real-time analysis and insight.

#### Your benefits at a glance:

- Benefit from advanced analytics without additional training
- End-to-end solution
- Build customer relationships and new business models

## Wide scalable web HMI/SCADA solution

### PROCON-WEB

The innovative HMI PROCON-WEB is the ideal human-to-machine interface. Important system features such as adaptive design for device-specific interfaces, support for a comprehensive range of communication drivers incl. OPC-UA, multi-lingual function and country-specific keyboard layouts, as well as simple engineering without programming expertise are the basis for a powerful and open system.

Choose from two variants: PROCON-WEB ES for embedded systems as a platform-neutral solution or PROCON-WEB SCADA as a windows-application for complex tasks.

#### Your benefits at a glance:

- Modern intuitive UI
- Flexible and high performance
- Open via interfaces and plug-ins
- "Security by design" concept

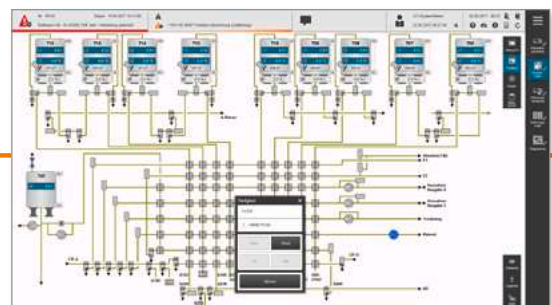



# Workplace & Accessories

Practical advantages for optimised work processes



[www.weidmueller.com/workplace\\_accessories](http://www.weidmueller.com/workplace_accessories)









## Professional solutions for systemised marking

### Industrial printing systems

Weidmüller marking systems are a fast and efficient way to produce markings and labels – e.g. for terminal blocks, wires, cables, and devices.

Our PrintJet CONNECT inkjet printer and MultiMark thermal transfer printer work fast and offer excellent print quality. The M-Print® PRO software makes identifying your electrical equipment convenient. The Klippon® Automated RailLaser, in conjunction with the Weidmüller Configurator (WMC), enables fully automatic marking of pre-assembled terminal strips.

#### Your benefits at a glance:

- Intuitive to use
- Constructive solutions for all control cabinet-related applications
- From shrink sleeves to metal markers
- Ink or thermal transfer technology – industrial printing systems for every requirement
- Designed with a glimpse into the future
- Fast and efficient marking of equipped mounting rails





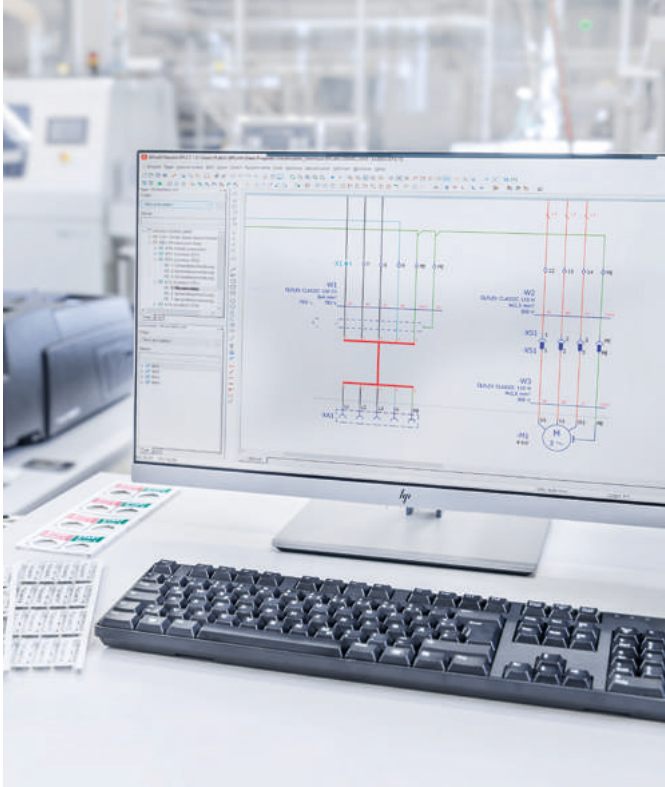

## Planning reliability through data consistency

### Software solutions

With our software solutions for marking (M-Print® PRO), semi-automated wire processing (WPC tool) and configuration (WMC), you are perfectly prepared for every project phase.

Thanks to interfaces to your eCAD system, you benefit from optimum data transmission from planning to commissioning.

#### Your benefits at a glance:

- Easy import, editing and management of data
- Intuitively operable software
- One software package for all applications

## Marking solutions for your industrial application

### Marker

Whether plastic or metal, whether individual marking or series marking – with our marking system, you will always find an optimal and at the same time economical solution for every task.

With MultiCard, MetalliCard, MultiMark or CableLine, you make the right decision.

#### Your benefits at a glance:

- Fast and economical marking
- Safety-compliant identification
- Laboratory-tested quality





## More efficiency by rational processes

### Automatic machines

The markets of the future demand further optimisation of installation times to rationalise the crimping processes; increasing automation of the individual steps is required.

With the intelligent combination of versatility and functionality, our machines enable efficient processing of conductor materials.

#### Your benefits at a glance:

- Increased efficiency due to automation
- Robustness and superior longevity
- Precision and repeat accuracy
- Modular assembly system

## Optimal illumination for cabinet and field application

### Industry light

The durable, space-saving and powerful LED lights meet the highest requirements in switch cabinets and applications in harsh environmental conditions.

Thanks to the robust housing, wide cone of light and uninterrupted power supply, Weidmüller industrial lights offer a ready-to-fit-solution for lighting, emergency lighting and power supply.

#### Your benefits at a glance:

- Full power in an instant
- Powerful and energy efficient
- Low sensitivity to external influences







## For a good climate and safe protection of your electronics

### Thermal management

The control of modern production processes is inconceivable without high-performance components in the control cabinet. Many of these electronic components must be protected against heat, cold, dust or dirt to achieve permanent and reliable functionality.

A thermal management system regulates the temperature inside the control cabinet and protects against further interfering influences.

#### Your benefits at a glance:

- Safe and at the same time economical cooling
- Three times longer service life
- Quick & tool-free assembly

## Incorporate the structures for flexibility inside the cabinet

### Cable ducts

Increasing trends in digitalisation require higher packing densities in the cabinet. Therefore, a clear and space-saving cable routing system is necessary. This is more than just a visual aspect, because orderly cable routing saves time and money. It facilitates maintenance and repair work and increases general operational safety.

The wide product range of cable ducts is complemented with a large number of useful accessories to support your cabinet.

#### Your benefits at a glance:

- Comprehensive product range
- Easy, safe and fast installation
- High flexibility due to a wide range of accessories

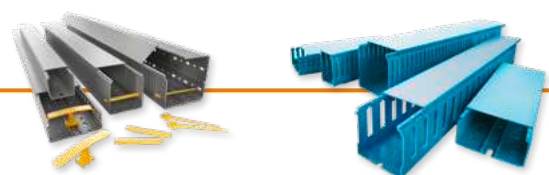
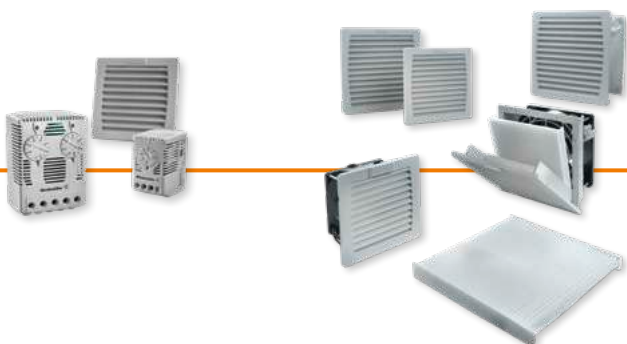

# Assembly

Our assembly service for more focus on your core business



[www.weidmueller.com/assembly](http://www.weidmueller.com/assembly)





## Proven solutions for your enclosure applications

### Klippon® Protect

With Klippon® Protect, you can choose from a wide range of universal and application-specific enclosures. The enclosures cover all relevant approvals required for use in industrial or explosive risk zones.

The flexible Klippon® Protect enclosure system is the perfect addition to our Klippon® Connect range of terminal blocks. Rely on our enclosures that are optimised for your requirements and provide excellent protection.

#### Your benefits at a glance:

- Individual or standardised assembled enclosures
- Advice with application expertise and industry know-how
- Innovative software and assembly services
- Perfectly tailored to your needs





## Ready-to-connect cables for every requirement

### Custom cable assemblies

Requirements of modern machines and plants are increasingly specialised. The consequence is increasingly modular concepts that can be flexibly adapted to new requirements. Standard combinations as well as customer-specific cabling solutions, which are available quickly and guarantee a reliable transmission of power, signals and data, are required for the implementation.

Consisting of either standardised or specific connecting lines – Weidmüller provides you with the optimal solution for every cabling project.

#### Your benefits at a glance:

- Universal connectivity from IP20 to IP6x
- Reduction of installation costs to a minimum
- Customised cable lengths, connecting plugs, markings or colours







## Produce faster with higher flexibility and efficiency

### Fast delivery service

Simply configure your assembled terminal rails, empty enclosure or assembled enclosure and it will be ready for dispatch after five or ten days depending on the service level selected. Get quotes around the clock and in minutes, including part numbers that can be ordered directly – 24 hours a day, seven days a week. Planning and configuration with the Weidmüller Configurator (WMC) are the key to consistent processes.

Simple operation, clear design and integration into your engineering workflows from planning with CAE to documentation make configuration simple, safe and convenient.

#### Your benefits at a glance:

- Significant minimisation of purchasing and storage costs
- Avoidance of assembly errors and increased reliability
- Individual terminal strips and enclosures from batch size 1





# Customised solutions

Coming together to create the future



[www.weidmueller.com/solutions](http://www.weidmueller.com/solutions)



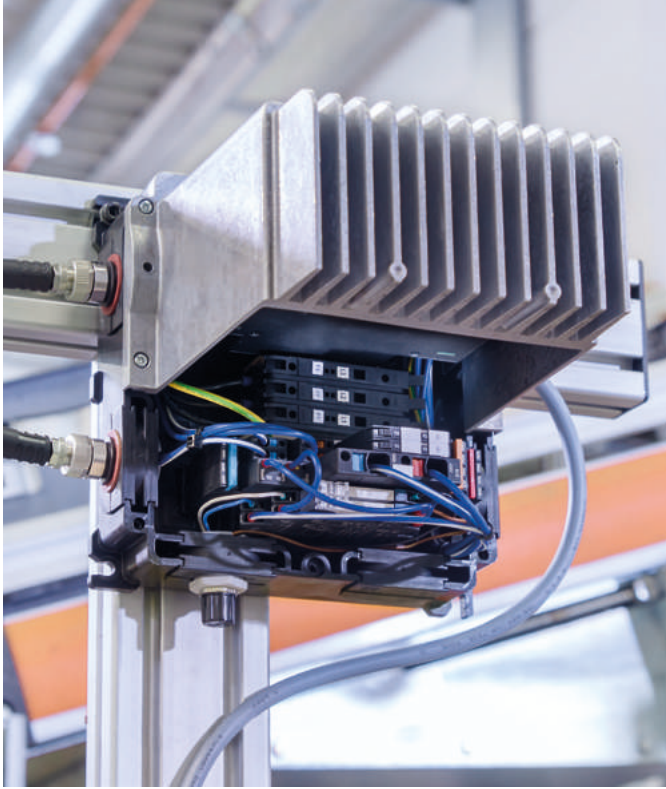

## Solving decentralised automation tasks economically

### FieldPower®

Function-based decentralisation is to make well-established control cabinet functions such as feed-in switching, protection and monitoring in the field. Weidmüller's FieldPower® system enables you to plan, install and operate decentralised plants and automation designs.

Our modular system is the ultimate economical solution for almost any decentralisation task – with flexible enclosure variants, cost-effective wiring and a wide range of functions.

#### Your benefits at a glance:

- Connecting automation and digitalisation
- Simple installation of IP20 components
- Modular principle of identical parts
- Range of combination options

## Optimise your energy consumption

### Energy management solutions

Energy management is a triad of recording all relevant energy consumption data, analysing the information obtained, and comprehensive consulting on possible saving potential.

We at Weidmüller see the development of an energy management system as a holistic task which combines expert advice with intelligent hardware and software solutions to form a strong unit. With ResMa® resource management software for process and energy optimization, you can improve your processes with the intelligent energy management that can be combined to Industrial IoT.

#### Your benefits at a glance:

- Continuous and reliable monitoring
- Detect residual currents
- Eliminate insulation faults in time
- Standard-compliant monitoring of power quality





## Charge for the change

### Charging box family AC SMART

The new charging box family AC SMART is ready for any application scenario in the private and commercial sector.

The platform-based charging concept with its basic equipment in three lines covers the most common applications and can be adapted to individual applications by means of standardised interfaces and versatile configuration options.

#### Your benefits at a glance:

- Simple & fast installation
- Intuitive – The perfect EV charging box for your home
- Secure – No overloading when installing multiple EV charging boxes
- Efficient – Fast charging through intelligent power distribution

## Operate photovoltaic systems economically and efficiently

### Photovoltaic solutions

Large photovoltaic systems as well as rooftop systems are associated with enormous costs and risks for owners and operators. Your goal is a long-term return on investment. Total cost of ownership is therefore a critical success factor.

The requirement for the development and construction of today's photovoltaic systems is to operate them efficiently – economically and without downtime. In addition, upcoming technological improvements such as decentralisation, IoT and data analysis play an important role for future photovoltaic ecosystems.

#### Your benefits at a glance:

- Protecting your investment
- Comprehensive portfolio
- Global project support by PV specialists
- Many years of industry experience







## Customised solutions for maximum profitability

### Wind solutions

Nowadays, the wind energy sector is faced with the challenge of meeting growing profitability requirements. Turbine manufacturers are therefore constantly seeking for possibilities to reduce the LCOE (levelized cost of energy).

Weidmüller meets this need with reliable components and customised solutions that reduce investment and operating costs. Weidmüller also offers proven solutions in the areas of automation and digitalisation to reduce downtimes and increase yields.

#### Your benefits at a glance:

- Rapid prototype development
- Global project support in all development phases
- Wide range of components

## Activating the power of new energy

### Power-to-X & Hydrogen

Hydrogen from renewable energy is considered the key technology for future climate neutrality in the energy industry. Our products offer a wide range of applications along the process chain of hydrogen production, storage, supply, processing as well as for battery storage of renewable energy.

We combine extensive experience in traditional process connection, protection and plant control, coupled with our strong involvement in the photovoltaic and wind industry. This makes us the ideal partner to support this change.

#### Your benefits at a glance:

- Specialised know-how from electrical connectivity to the cloud
- Experience and industrialisation expertise
- Certification competence (e.g. Ex, IECEx)





## The easy way "from data to value"

### Our Industrial IoT portfolio

The way to Industrial IoT does not have to be complicated. Whether you need access to valuable data, or want to offer new, data-driven services – we pave the easy way "from data to value".

Our comprehensive and cutting-edge IIoT portfolio is suitable for both greenfield and brownfield applications. We offer components and solutions ranging from data acquisition and pre-processing to data communication and data analysis.

#### Your benefits at a glance:

- Simple and fast retrofitting of IoT solutions
- Open and web-based engineering
- Better positioned for the future

## Optimize your automation with u-mation

### Easy and Industrial IoT ready

u-mation is characterised by flexibility to meet today's requirements. The future-proof u-mation portfolio consists of powerful controllers, modular I/O system, simple visualisation systems and customised software as well as engineering tools.

u-mation offers you a consistent portfolio across the 4 levels of the Industrial IoT: data acquisition, data pre-processing, data communication, up to data analysis. Ready for the future of automation. u-mation – More Performance. Simplified.

#### Your benefits at a glance:

- Simple in use
- Strong partnerships
- Future-proof portfolio





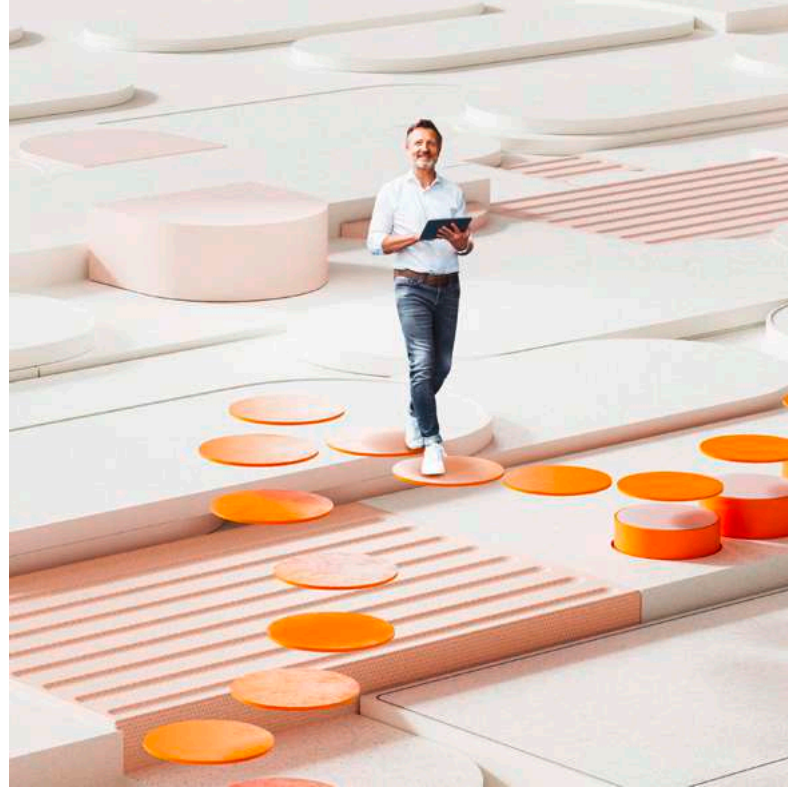
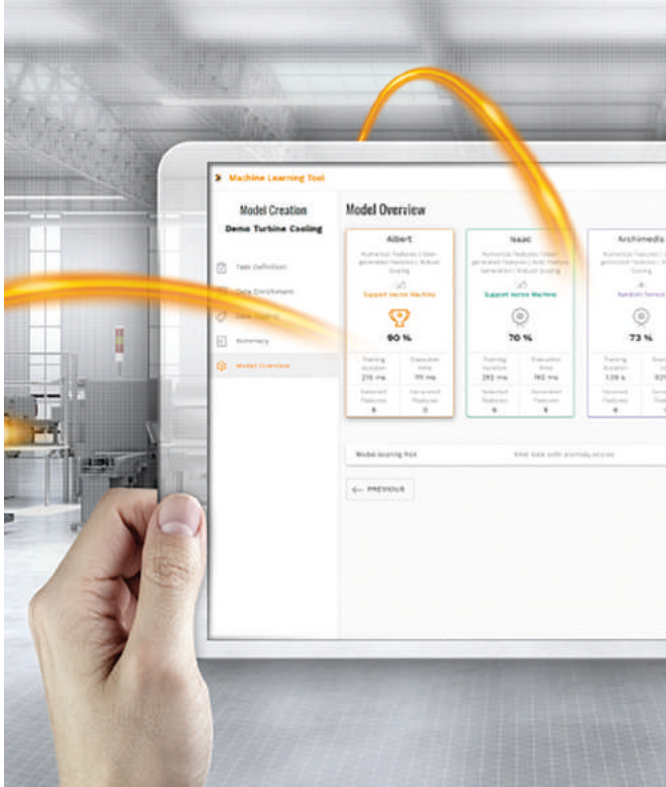

## Make your machines smart Industrial Analytics

Weidmüller's Industrial Analytics offer stands for application-oriented AI applications that help you to detect and classify anomalies in order to effectively reduce downtimes. Through predictive maintenance, you can plan service intervals in a targeted manner, as and when required.

What is more, you can make reliable predictions about the quality of your products, based on seamless recordings of sensor, condition and process data.

### Your benefits at a glance:

- 100 % security for your data
- A strong partner with industry expertise
- Complete solutions from a single source

## Your ticket to the world of digital service easyConnect

Our cloud-based platform is your ticket to the world of digital services from Weidmüller, and the intuitive and future-proof tool for your way to the Industrial IoT. Realise your use cases easily, consistently and without any relevant prior knowledge, thanks to the perfect interaction of platform, devices and diverse software services.

As an open, modular and perfectly integrable system, the platform is your enabler for a wide range of use cases. Increase your efficiency and unleash your full innovation potential with easyConnect.

### Your benefits at a glance:

- Common user experience
- End-to-end IIoT solutions
- Modular & scalable services

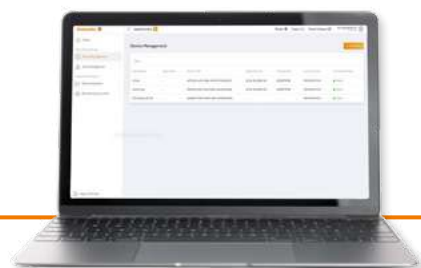
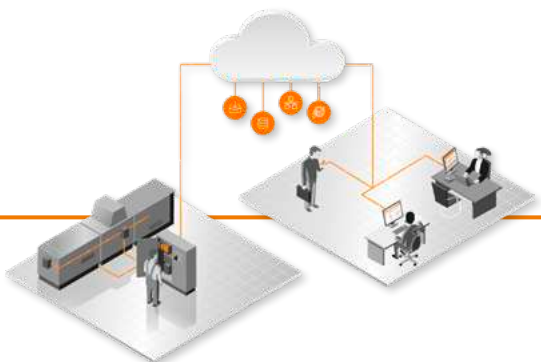

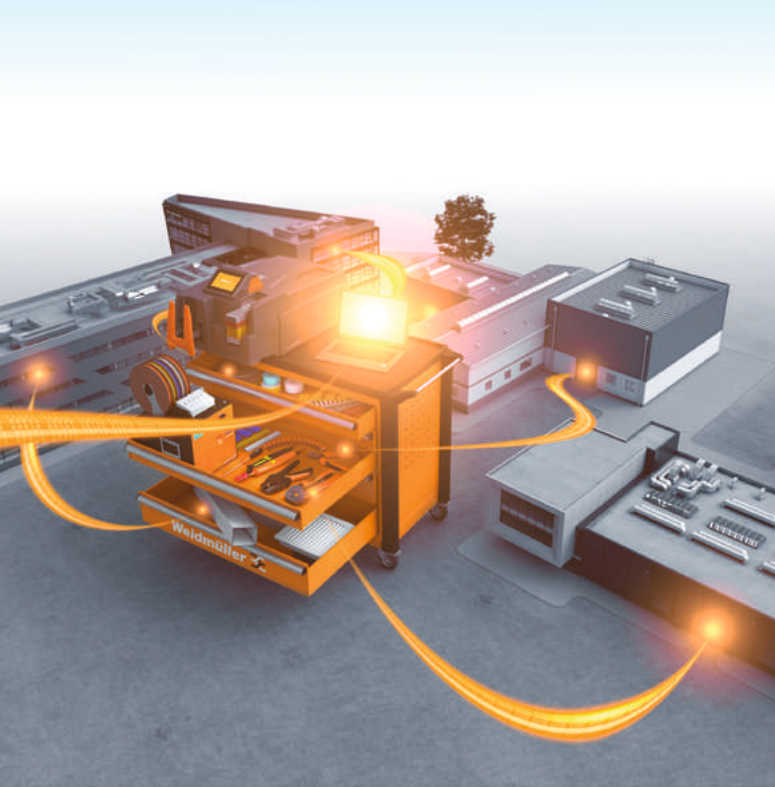

## Optimise your panel building processes

### Workplace solutions

With Weidmüller, you have the perfect partner at your side to support you in all phases of panel building, from planning to installation to operation, with optimally coordinated solutions for your workshop.

Based on years of experience in panel building, we will enable you in speeding up your work processes and increasing your quality through effective utilisation of our comprehensive portfolio.

#### Your benefits at a glance:

- 80 % faster and safer processes
- 100 % premium quality
- Increased productivity

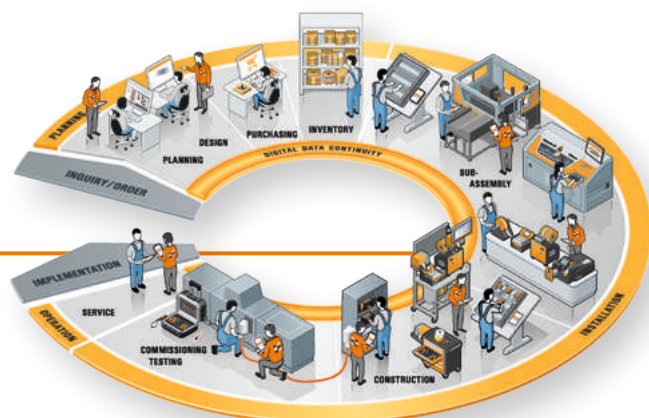

## Expert knowledge for cabinet building

### Connectivity Consulting

Together, we will make your cabinet building future-proof! Our team of engineers, in collaboration with your experts, analyzes each individual step of your workflow, from planning to commissioning. Together, we precisely identify the interfaces and processes that offer potential for optimization.

With an external perspective, our extensive expertise, and the aid of various Lean management tools, we develop customized solutions for your requirements and assist you in implementing the measures on-site – your opportunity to remain competitive in the future and counteract the shortage of skilled workers.

#### Your benefits at a glance:

- Optimization of your work processes
- Extensive practical experience
- Unbiased view of your processes
- Growing together





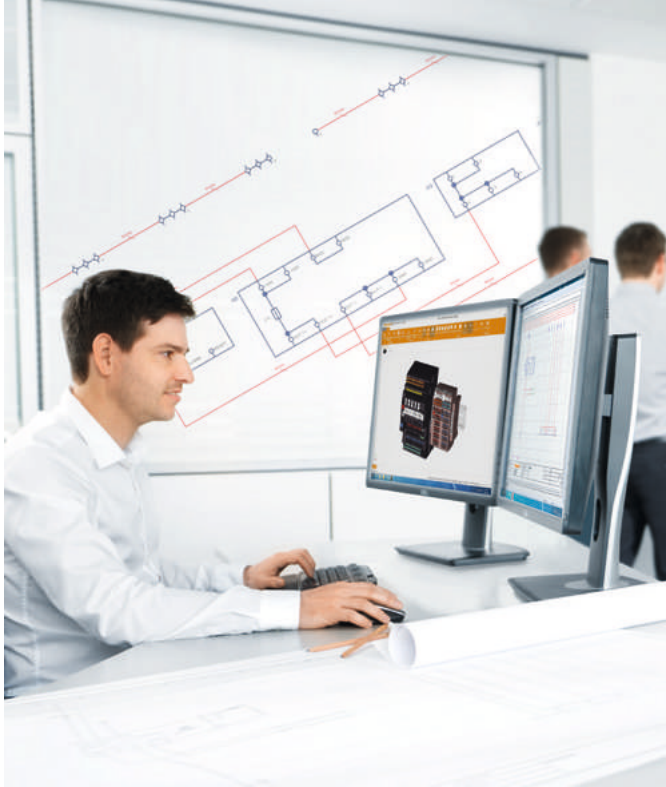

## Digital engineering – intuitive, uncomplicated, fast

### The Weidmüller Configurator

Digital engineering can be as simple as that! Create your own configuration from over 10,000 digital Weidmüller products.

As a software solution, the Weidmüller Configurator not only offers support for the individual work steps, but for panel building as an entire, seamless process, building a bridge from planning through to operation.

#### Your benefits at a glance:

- Provision of intelligent item data
- Simple and secure ordering
- Always the right configuration
- Fast and simple product enquiry



## The network infrastructure for the Industrial IoT

### Single Pair Ethernet

The increasing level of digitalisation in industrial plants requires a further development of existing Ethernet cabling. Especially for sensors and local modular control units, conventional wiring concepts can no longer meet the new requirements in terms of space requirements and installation effort.

Weidmüller and partners from the field of electrical connectivity all rely on the innovative Single Pair Ethernet technology when developing new industry standards.

#### Your benefits at a glance:

- Easy to install
- Noticeable reduction in space and weight
- High robustness
- Long cable lengths with extremely compact design types



## **Our expertise for your requirements** Service connects – worldwide

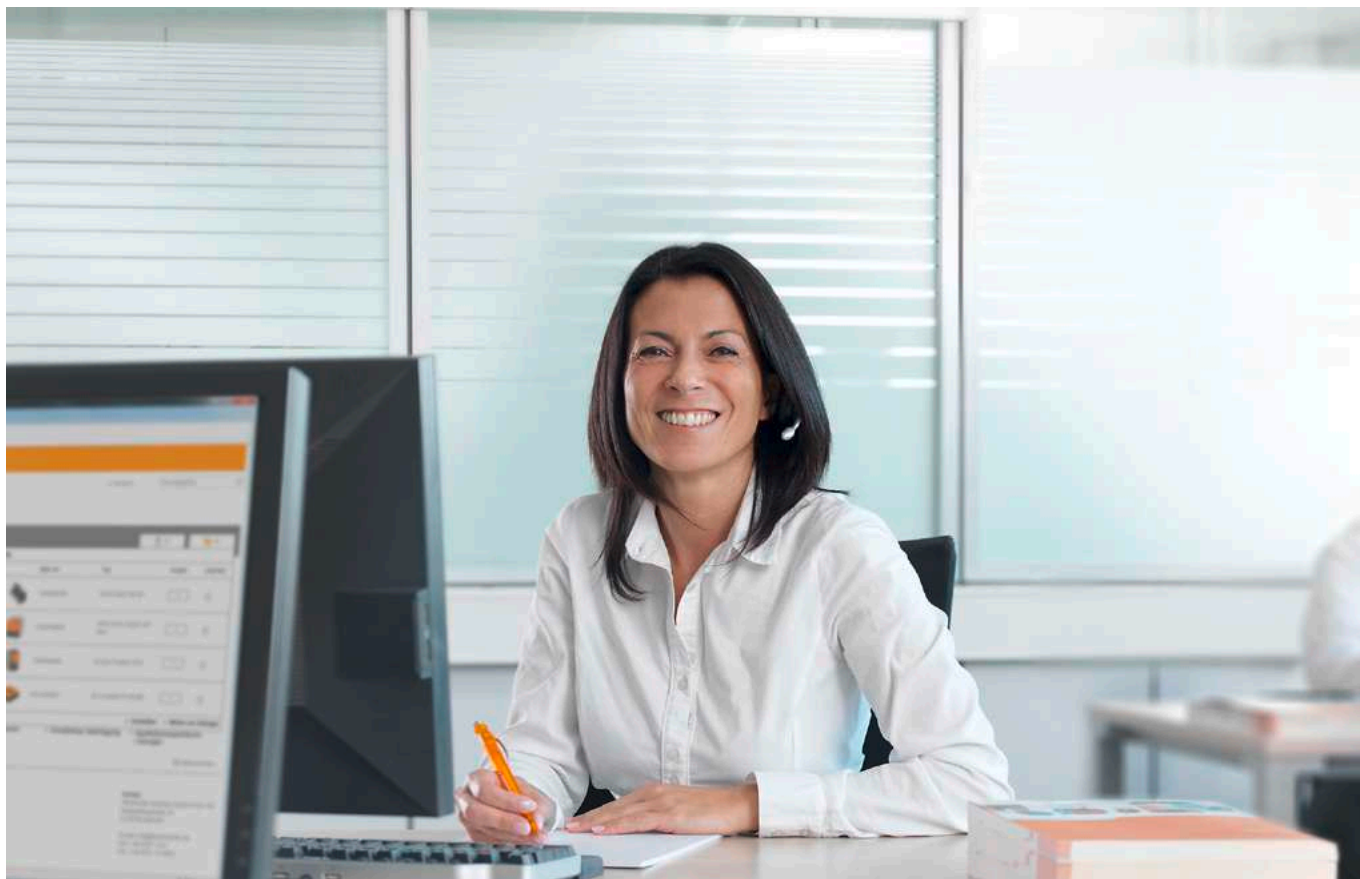

Automation technology functions are becoming more complex in a globally-oriented world facing ambitious targets in terms of energy efficiency and smart production. We are your equal partners for the best connections in Industrial Connectivity.

Our personal support answers all questions reliably and expertly. During planning, installation or operation our service and support offer is your best companion.

In short: Weidmüller's global service combines our expertise with your requirements.



**Your way to our service**  
[www.weidmueller.com/service](http://www.weidmueller.com/service)



## Expand the possibilities of our products

Our Support Center provides you with comprehensive, clear and personal assistance



Receive fast and intuitive support to get the most out of our products in your application. In our new Support Center you can search or navigate to the many application notes, product information, video tutorials or software downloads of our products.

- **Everything at a glance** – One central support hub, where all relevant information is available
- **Powerful search** – Provides filter functions for various types of information and products
- **Different views and navigations** – Content provided in views product information, engineering support or software downloads
- **More than 170,000 downloads** – Application notes, video tutorials, templates and examples, user documentation, engineering data, ...
- **Personal contact** – Direct access to your personal technical contact in your country



Explore the world of our new Support Center  
[support.weidmueller.com](https://support.weidmueller.com)

## Weidmüller – Your partner in Smart Industrial Connectivity

As experienced experts we support our customers and partners around the world with products, solutions and services in the industrial environment of power, signal and data. We are at home in their industries and markets and know the technological challenges of tomorrow. We are therefore continuously developing innovative, sustainable and useful solutions for their individual needs. Together we set standards in Smart Industrial Connectivity.

Weidmüller Interface GmbH & Co. KG  
Klingenbergstraße 26  
32758 Detmold, Germany  
T +49 5231 14-0  
F +49 5231 14-292083  
[www.weidmueller.com](http://www.weidmueller.com)

Personal support can  
be found on our website:  
[www.weidmueller.com/contact](http://www.weidmueller.com/contact)

Made in Germany



Order number: 2968340000/07/2023/SMM