



03PBTE400T



Qualificada pela E-REDES
DMA-C62-807/N
Edição 3



PORTINHOLA PBTE 400

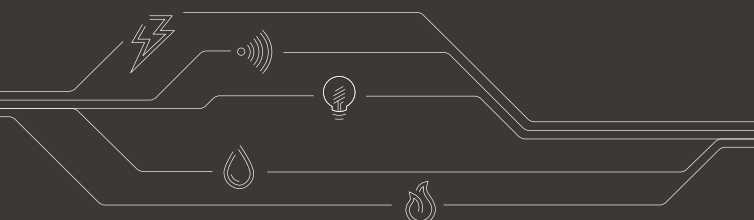

03PBTE400T PORTINHA EQUIPADA TRIFÁSICA COM ISF2 E BASE NEUTRO SECCIONÁVEL

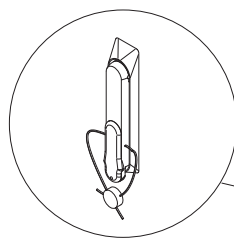
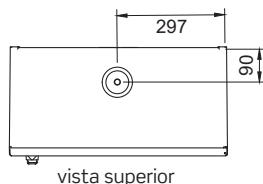
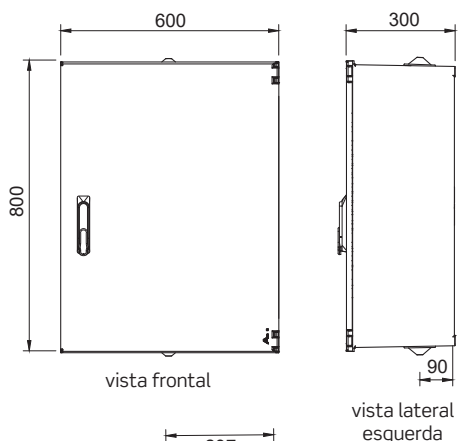
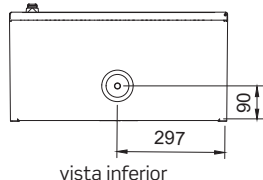
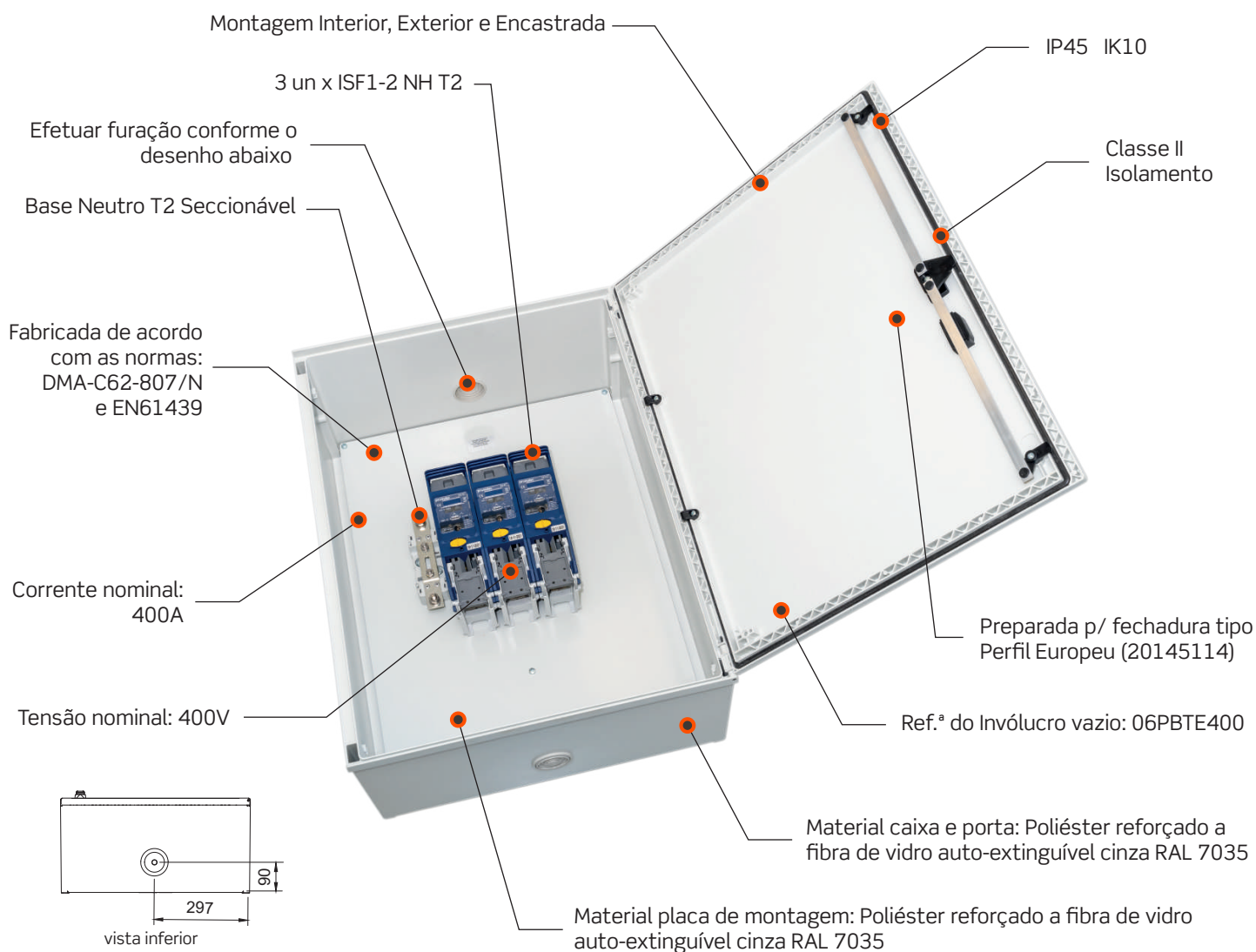

NOTA: Manípulo preparado para fio de selagem

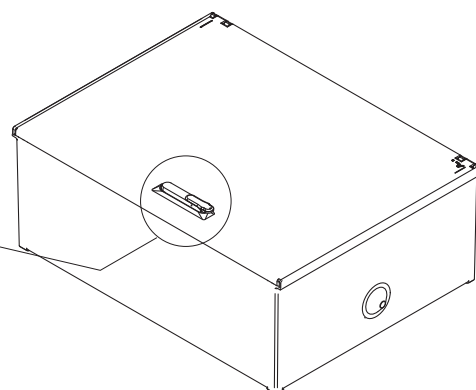

Consulte a nossa gama completa de produtos em www.al.pt



AL - Fábrica de Material Eléctrico, SA
Zona Industrial Casal da Lebre
Rua da Alemanha, Lote 6B
2430-028 Marinha Grande
Portugal

+351 244 572 280
(chamada para rede fixa nacional)

geral@al.pt
comercial@al.pt

www.al.pt

