

# Manual de ensamble

---

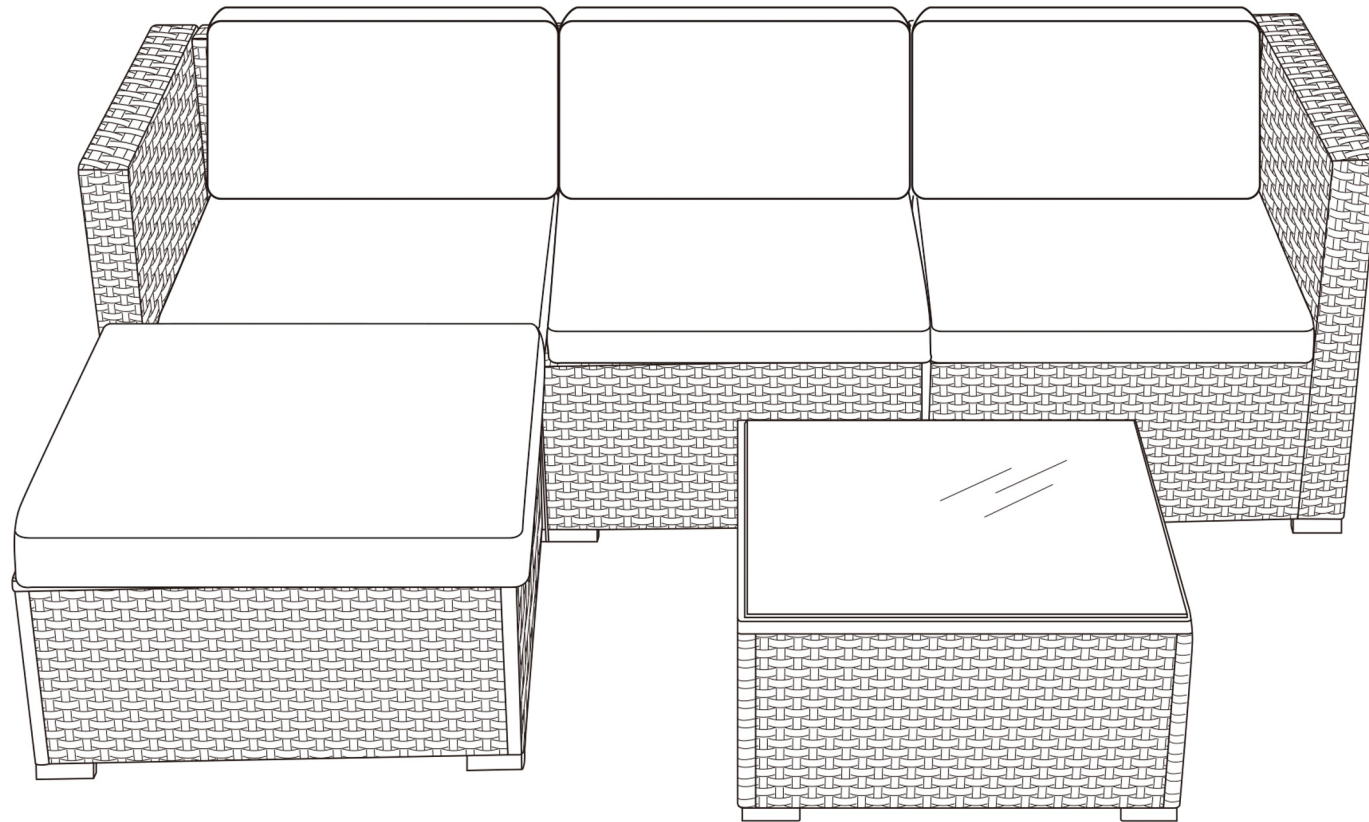







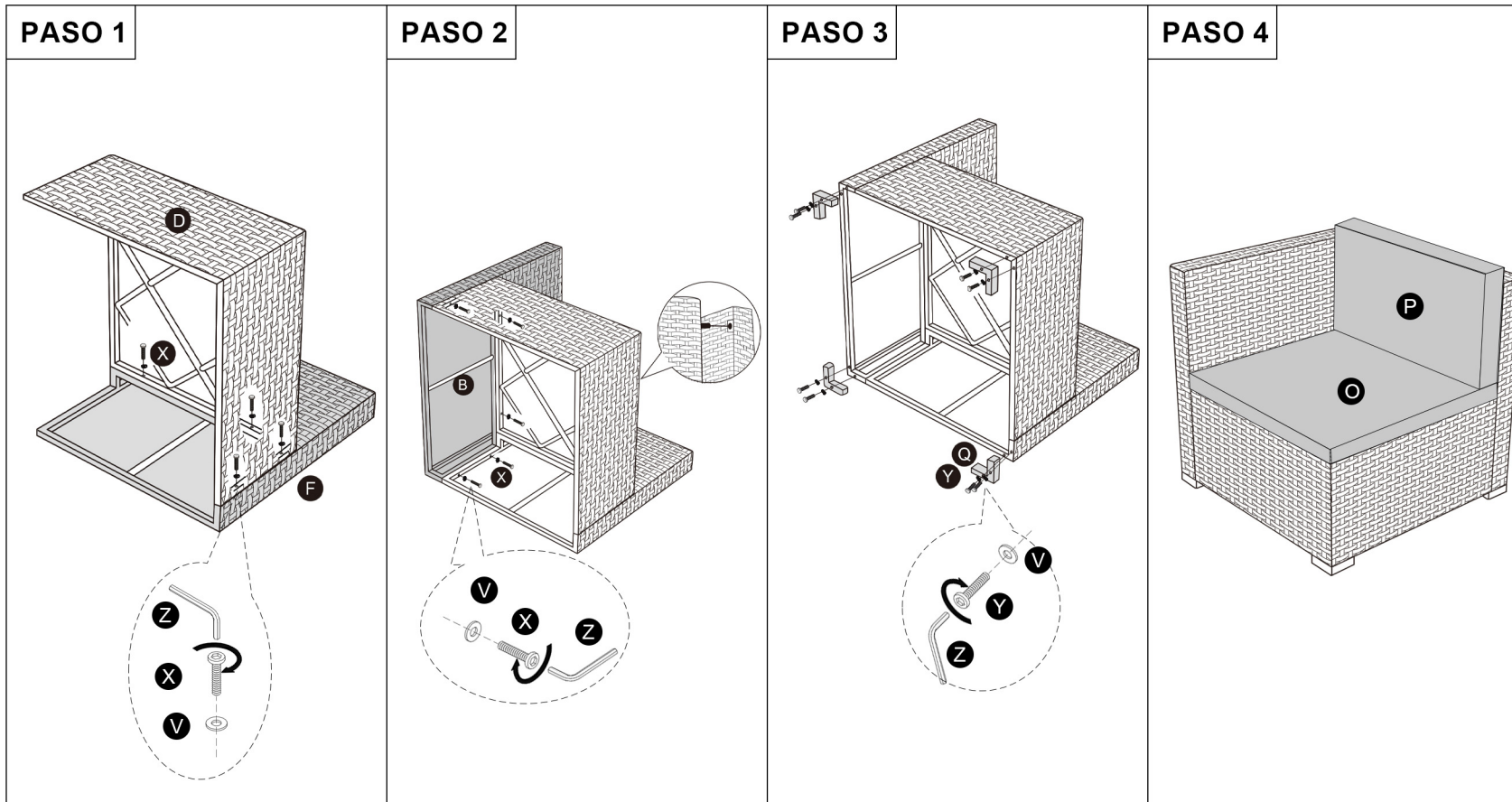

---



# Manual de ensamble

CANTIDADES POR PARTES



<b>B</b>	
1PCS	
<b>D</b>	
1PCS	
<b>F</b>	
1PCS	
<b>O</b>	
1PCS	
<b>P</b>	
1PCS	
<b>Q</b>	
4PCS	
<b>X</b>	M6*35mm 
9PCS	
<b>Y</b>	M6*25mm 
8PCS	
<b>Z</b>	
1PCS	
<b>V</b>	
17PCS	

# Manual de ensamble

CANTIDADES POR PARTES

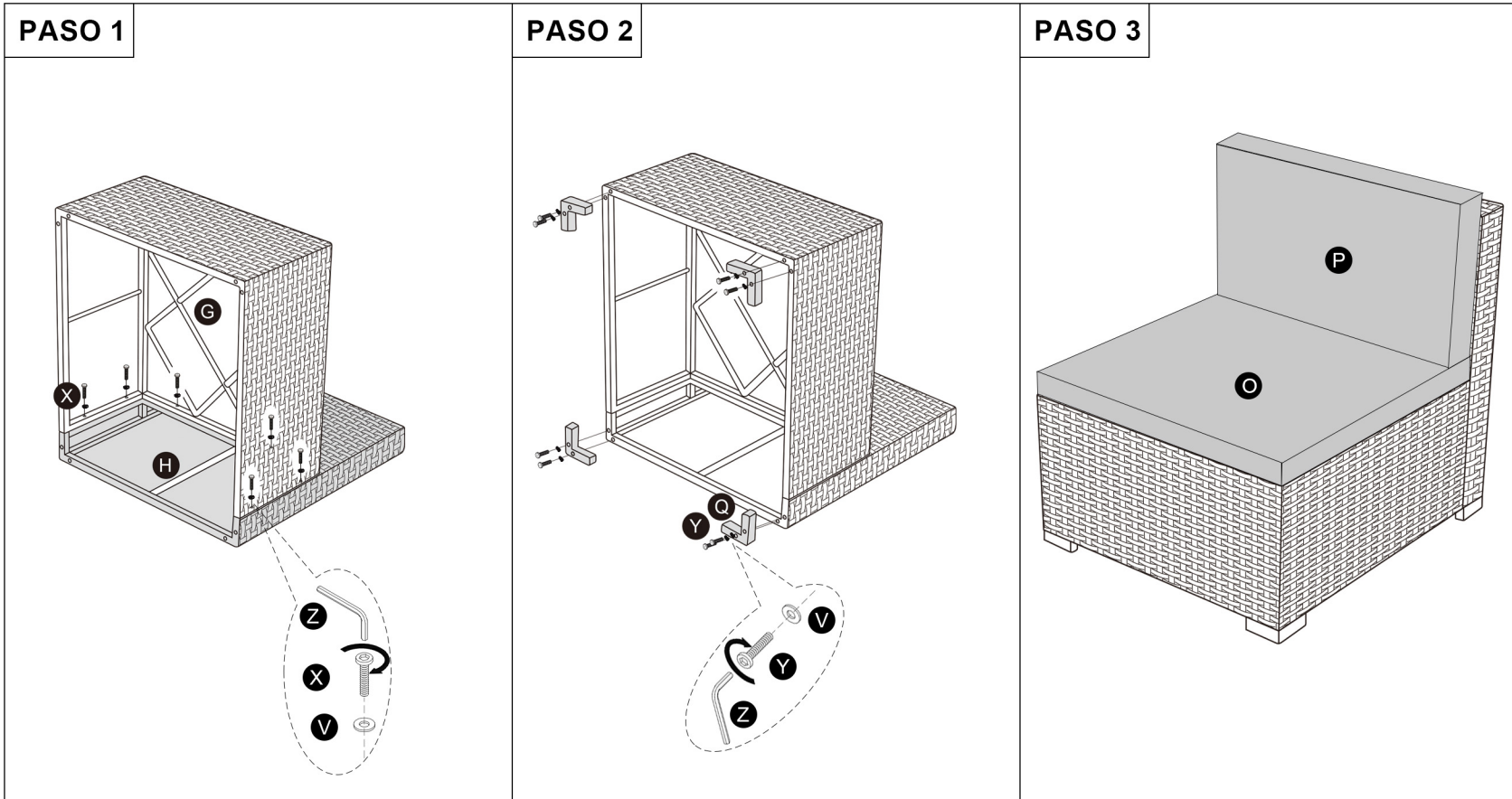

<b>G</b>	
1PCS	
<b>H</b>	
1PCS	
<b>O</b>	
1PCS	
<b>P</b>	
1PCS	
<b>Q</b>	
4PCS	
<b>X</b>	M6*35mm 
6PCS	
<b>Y</b>	M6*25mm 
8PCS	
<b>Z</b>	
1PCS	
<b>V</b>	
14PCS	

# Manual de ensamble

CANTIDADES POR PARTES

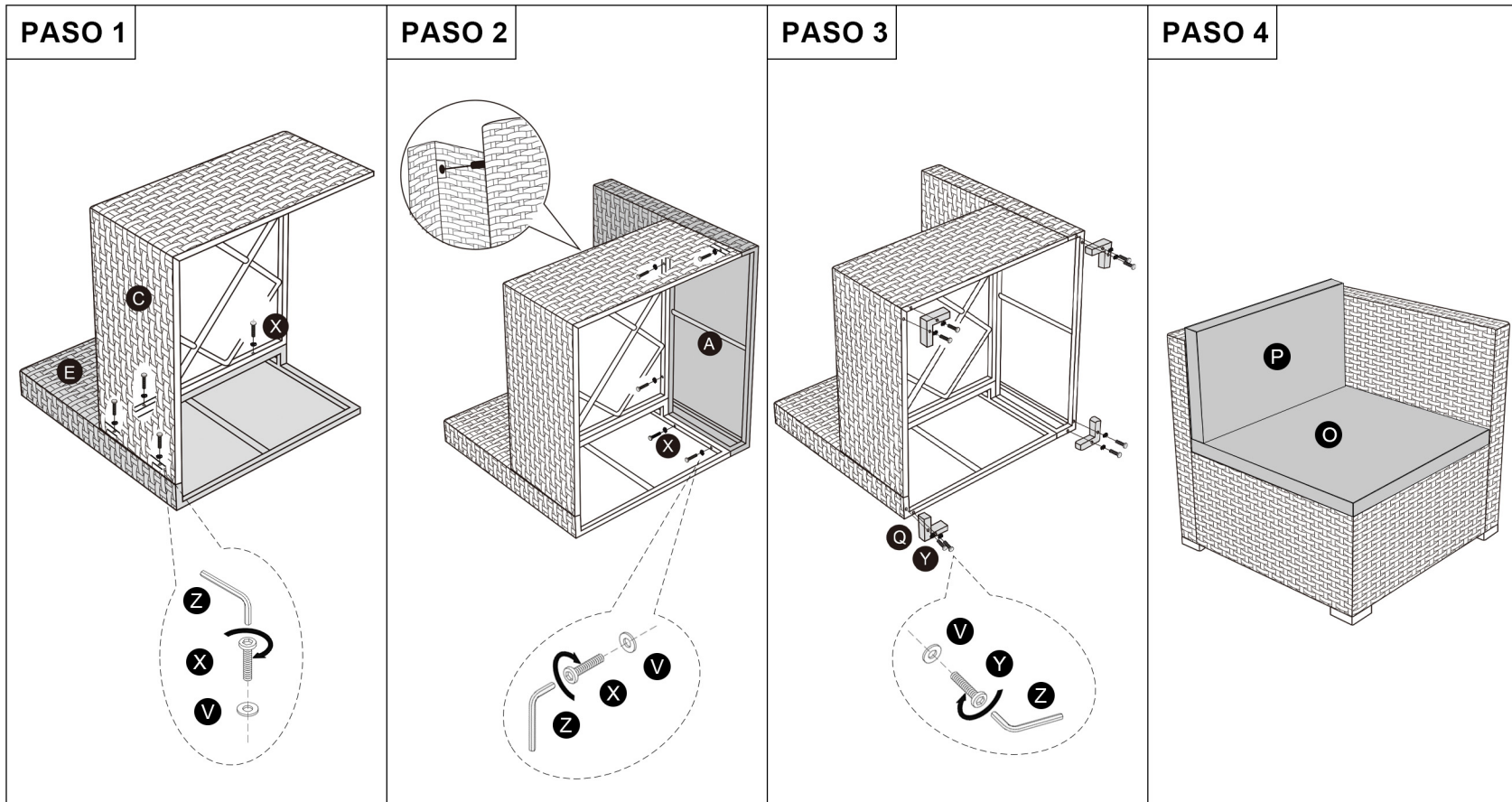

<b>A</b>	
1PCS	
<b>C</b>	
1PCS	
<b>E</b>	
1PCS	
<b>O</b>	
1PCS	
<b>P</b>	
1PCS	
<b>Q</b>	
4PCS	
<b>X</b>	M6*35mm 
9PCS	
<b>Y</b>	M6*25mm 
8PCS	
<b>Z</b>	
1PCS	
<b>V</b>	
17PCS	

# Manual de ensamble

CANTIDADES POR PARTES

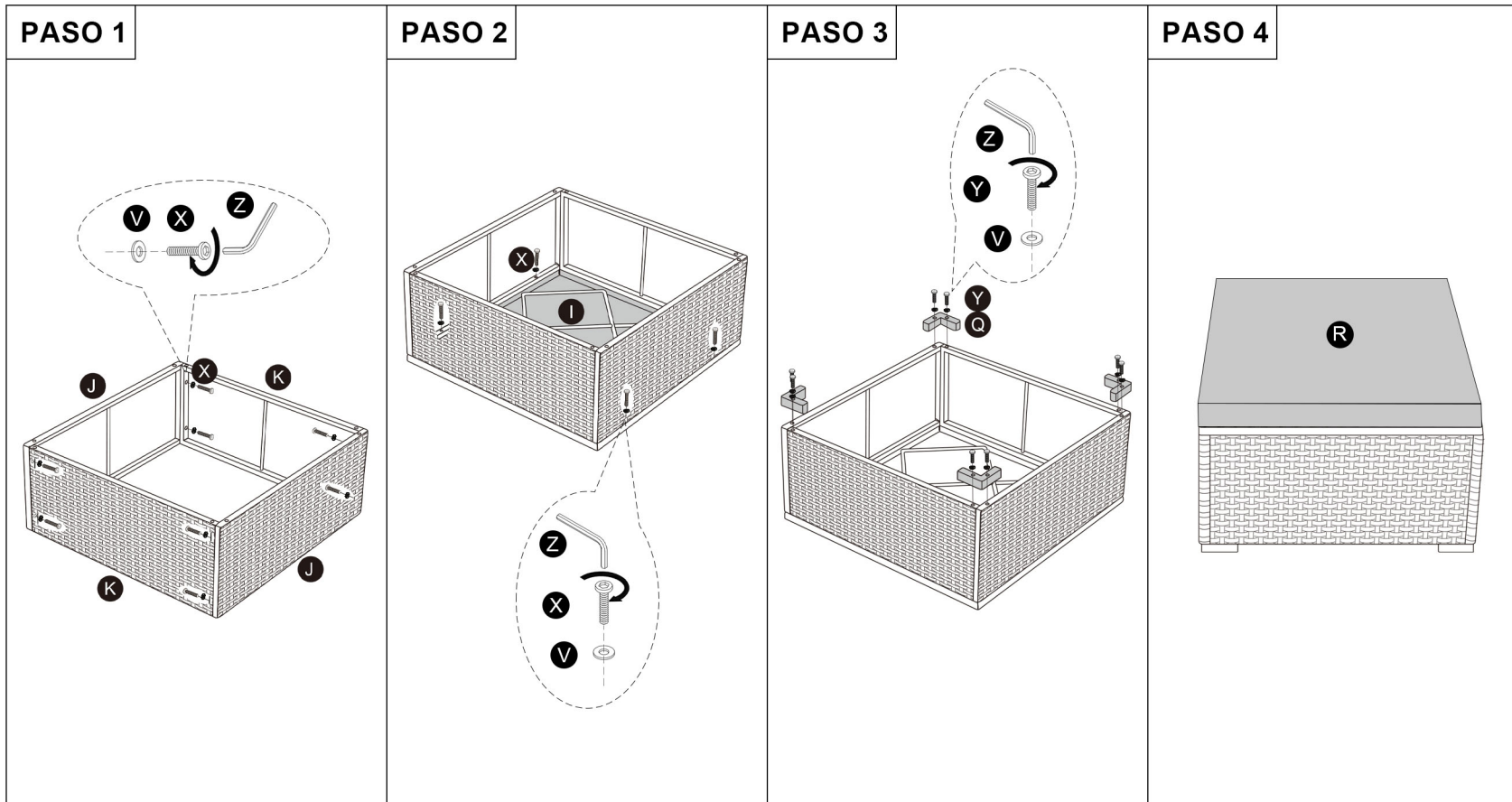







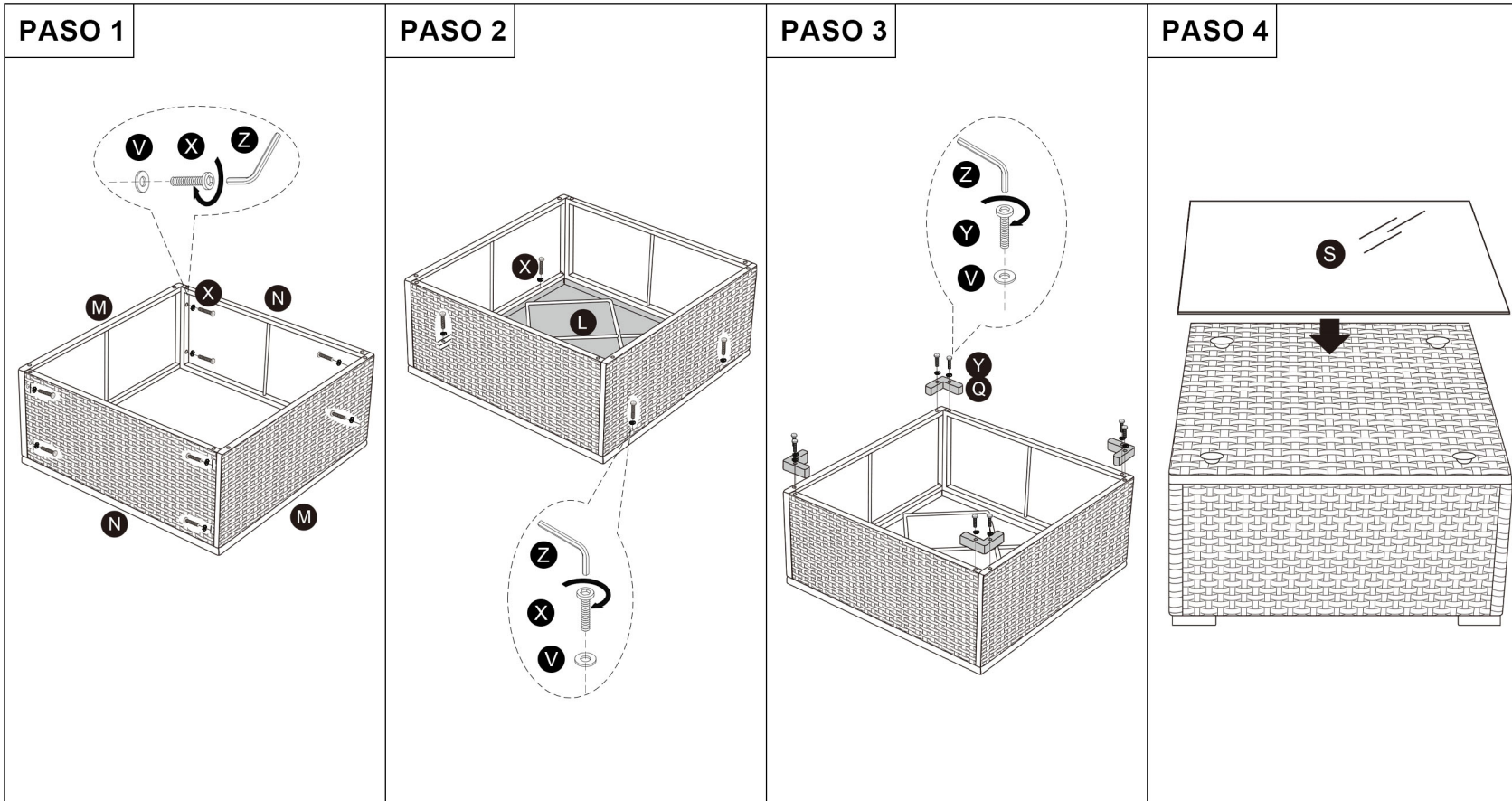

<b>I</b>	
1PCS	
<b>J</b>	
2PCS	
<b>K</b>	
2PCS	
<b>R</b>	
1PCS	
<b>Q</b>	
4PCS	
<b>X</b>	M6*35mm 
12PCS	
<b>Y</b>	M6*25mm 
8PCS	
<b>Z</b>	
1PCS	
<b>V</b>	
20PCS	

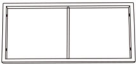
# Manual de ensamble

CANTIDADES POR PARTES



<b>L</b>	
1PCS	
<b>M</b>	
2PCS	
<b>N</b>	
2PCS	
<b>S</b>	
1PCS	
<b>Q</b>	
4PCS	
<b>X</b>	M6*35mm 
12PCS	
<b>Y</b>	M6*25mm 
8PCS	
<b>Z</b>	
1PCS	
<b>V</b>	
20PCS	