

INSTRUCCIONES DE ARMADO / ASSEMBLY INSTRUCTIONS CAMA 120 KAIA / KAIA 120 BED

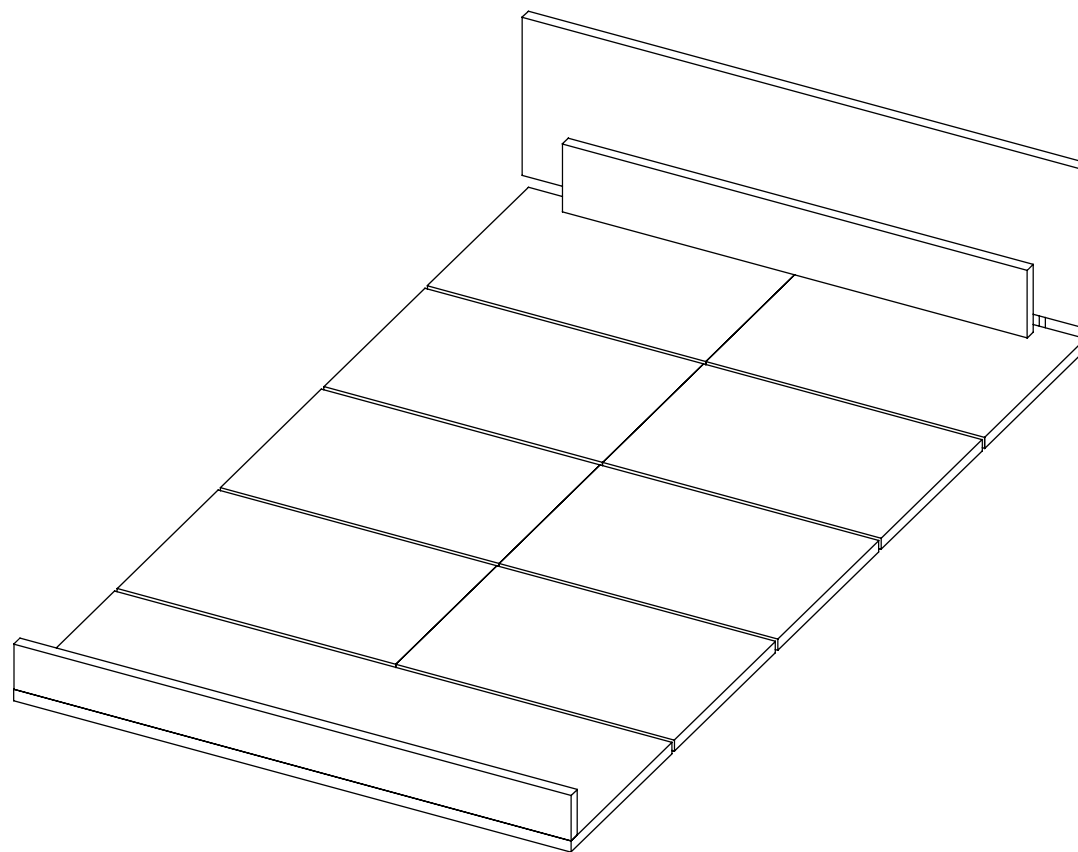

LOT N°

RTA[®]
m u e b l e s

Tel: (602) 695 9581 / 695 91 81 | EXT 118
La Nueva Estancia, Yumbo - Valle del Cauca - Colombia
www.rta.com.co

¡ATENCIÓN! / ATTENTION!

En las próximas páginas está el contenido de las piezas y herrajes del mueble. Asegúrate de que la cantidad de herrajes y piezas que hay en la caja sea la correcta y todo esté en buen estado. Ya que cuando el mueble esté armado no podrás realizar ninguna reposición.

On the next pages is the content of the pieces and hardware of the furniture.

Make sure the number of hardware and parts in the box is correct and everything is in good condition. When the furniture is assembled you will not be able to make any replacement

Recomendaciones Importantes / Key Recommendations

- Ensamble el mueble entre dos personas. / Assemble the cabinet between two people.
- Ensamble el mueble sobre una superficie plana y lisa, preferiblemente sobre un tapete o el cartón de la caja. / Assemble the cabinet on a flat smooth surface, preferably on a carpeted floor or the box carton.
- Se recomienda utilizar un destornillador eléctrico para facilitar el ensamble / It is recommended to use an electric screwdriver to facilitate assembly.

Herramientas Necesarias / Required Tools



Destornillador de estrella
Phillips Head
Screwdriver



Destornillador de pala
Flat Head
Screwdriver

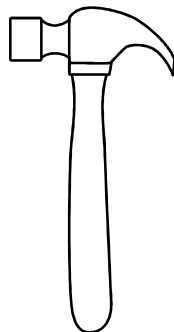

Martillo
Hammer

Herrajes Básicos / Basic Hardware

Aplica estas instrucciones cada vez que vayas a utilizar uno de estos herrajes durante el armado. / Apply these instructions everytime you're using one of these connectors during the assembly.

Tarugos / Wood Dowels

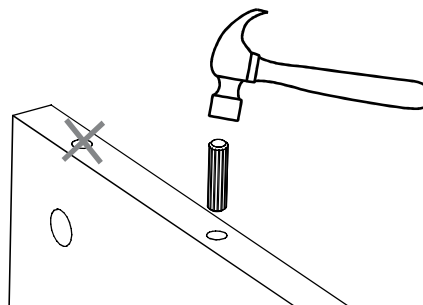

1. Inserta el tarugo en la perforación indicada y golpéalo suavemente hasta que llegue hasta el final de la perforación. / Put in the dowel inside the indicated hole and softly hit it until it's fully inside.

2. Verifica que NO se inserte el tarugo en la perforación de la caja minifix. / Verify that the dowel is NOT inserted into the perforation of the minifix cam.

Minifix y Pernos / Minifix Cam & Spreading Bolt

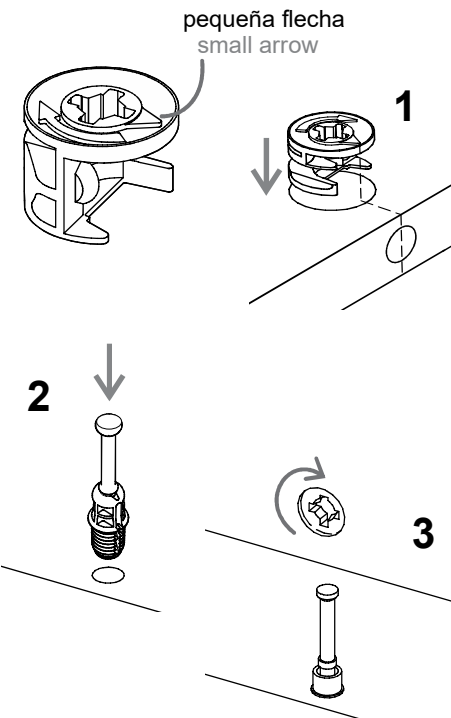





1. La caja minifix tiene una pequeña flecha en su parte superior, se debe insertar las cajas minifix con la flecha apuntando hacia la perforación que hay en el borde de la pieza. / The Minifix cam has a little arrow on its upper surface you should insert these cams with the little arrow pointing towards the drilling on the panel's edge.

2. Se debe insertar el perno con la parte plástica hacia abajo. / The spreading bolt should be put with the black plastic part facing down.

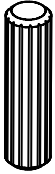
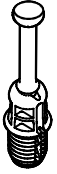
3. Luego de unir las piezas, se deben girar 180° las cajas minifix con un destornillador de estrella para ajustar y asegurar el ensamble. / After joining two panels together you should turn the cams 180° with a phillips head screwdriver to adjust and secure the joint.

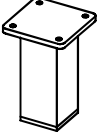
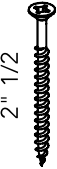
Herrajes / Hardware

 <p>Tarugo / Wood dowel</p> <p>x14</p>	 <p>Perno Minifix / Spreading Bolt</p> <p>x14</p>	 <p>Caja Minifix / Minifix Cam</p> <p>x14</p>	 <p>Tapa Minifix / Cover Caps</p> <p>x90</p>
 <p>Patas de aluminio / Aluminium Leg</p> <p>x9</p>	 <p>2" 1/2</p> <p>Tornillo ensamble / Drywall screw</p> <p>x22</p>	 <p>1 3/4"</p> <p>Tornillo ensamble / Drywall screw</p> <p>x104</p>	

Cargas Máximas / Max Suggested Loads

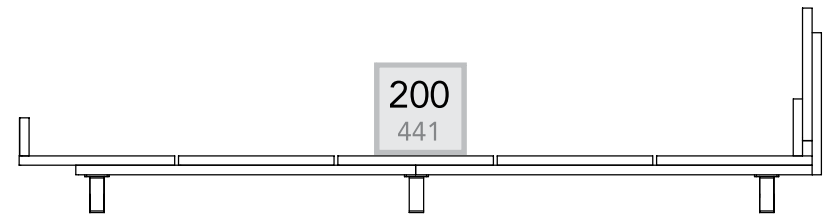

*Peso en Kg / Weight in Kg.

*Peso en Libras / Weight in Lb

Piezas de Armado / Assembly Parts

A - x1
B - x1
C - x1
D - x1
E - x2
F - x2
G - x1
H - x1
I - x2
J - x1
K - x1
L - x3
M - x2
N - x1

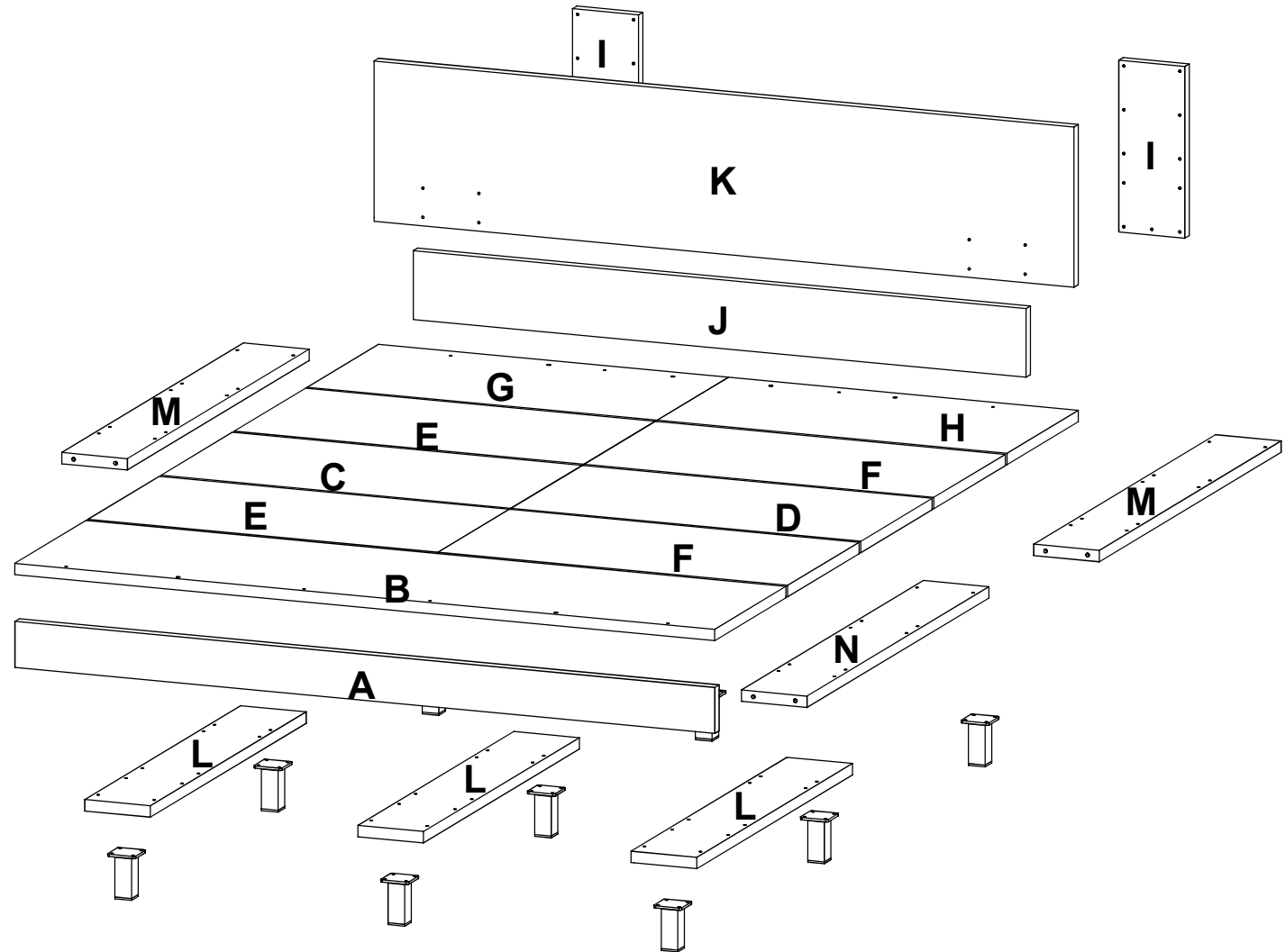

1

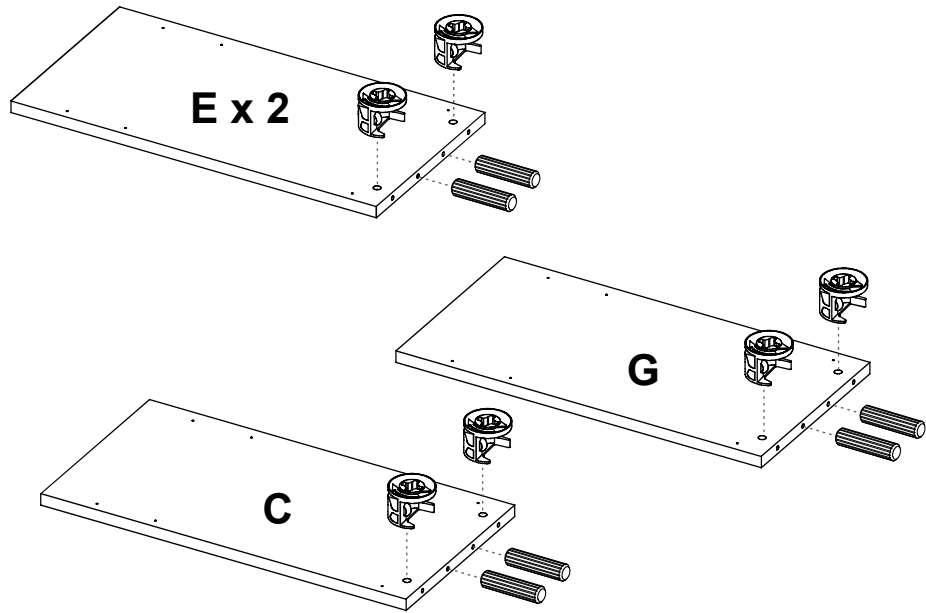

2

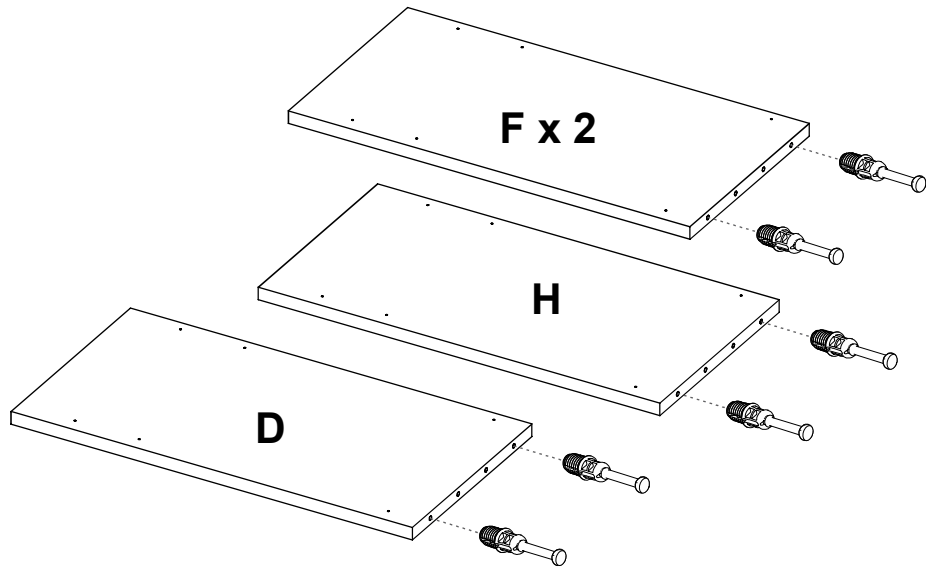

3

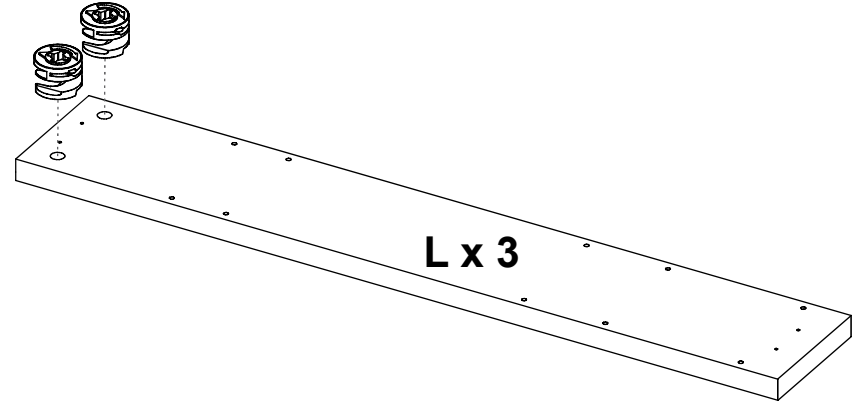

4

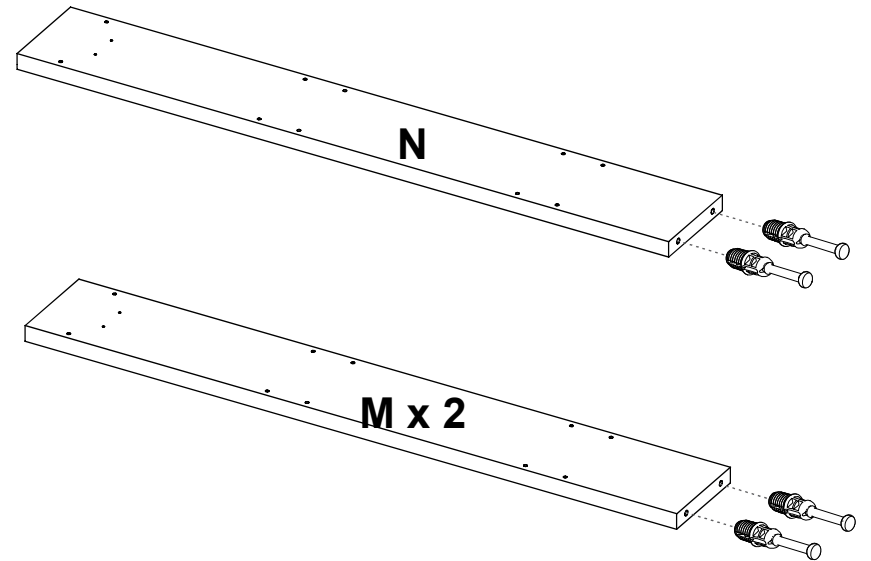

5

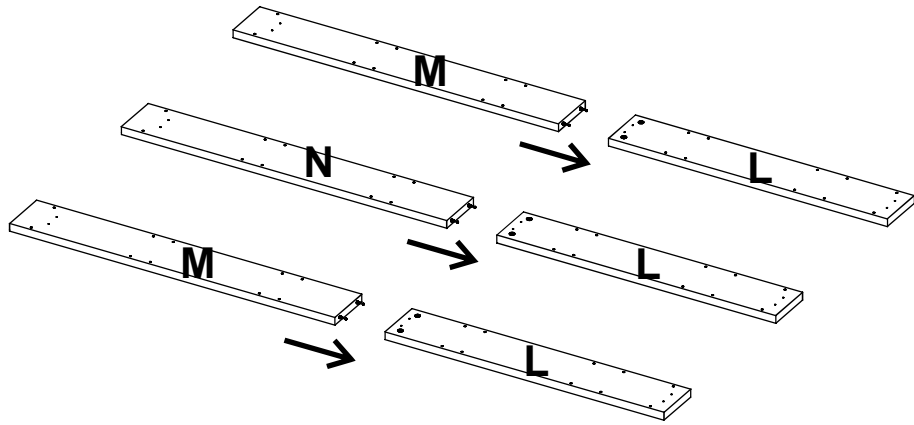

6

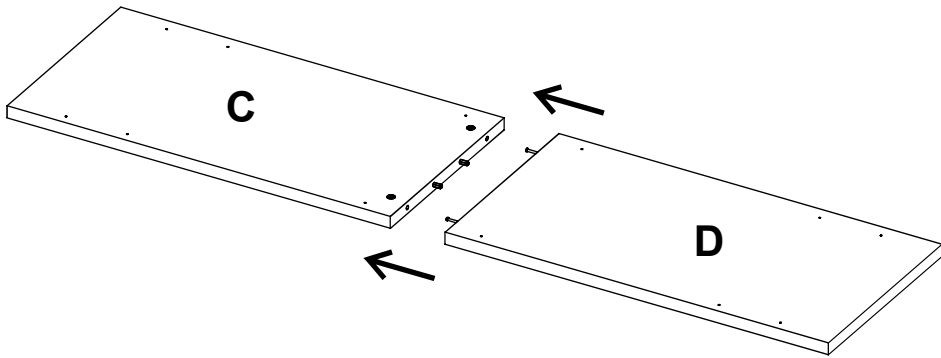

7x2

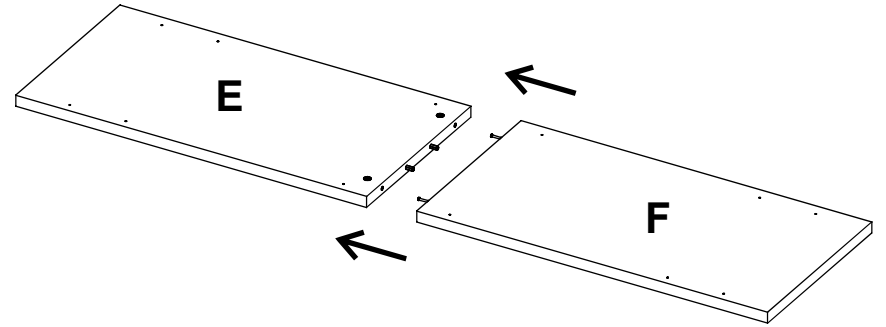

8

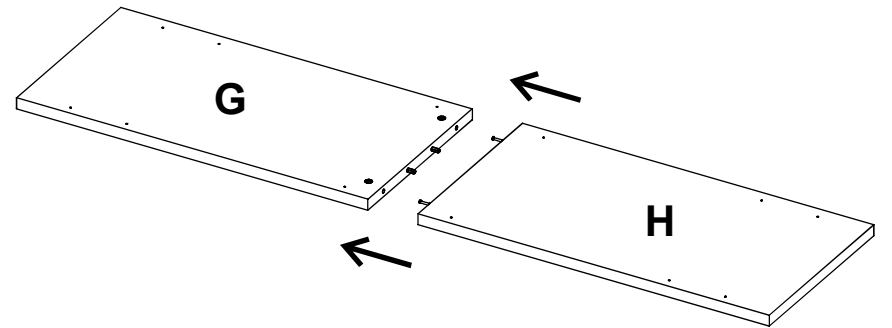

9

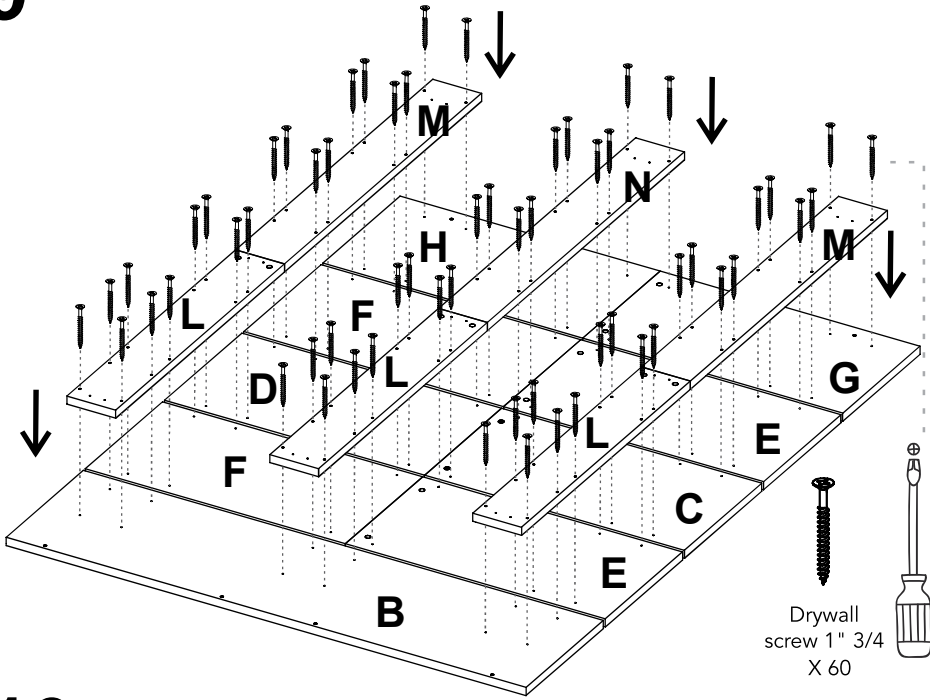

10

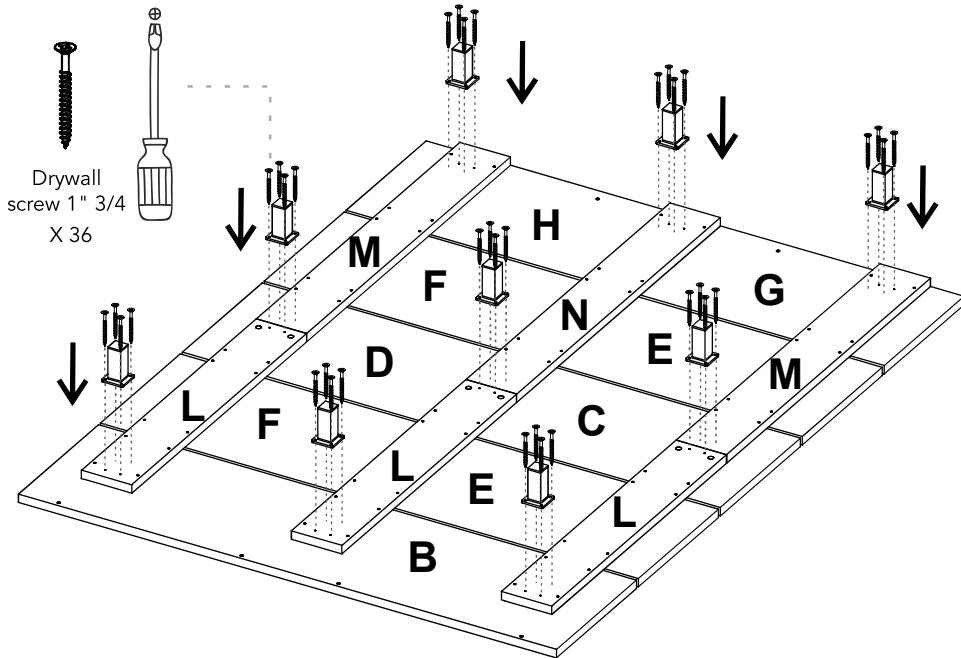

11

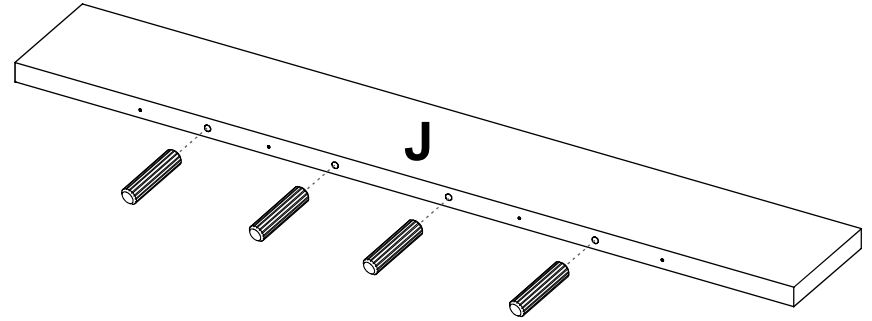

12

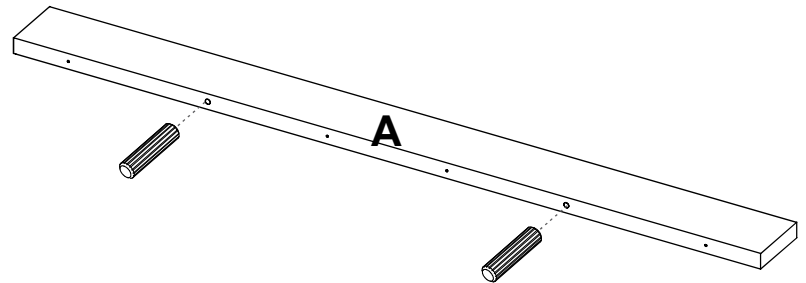

13

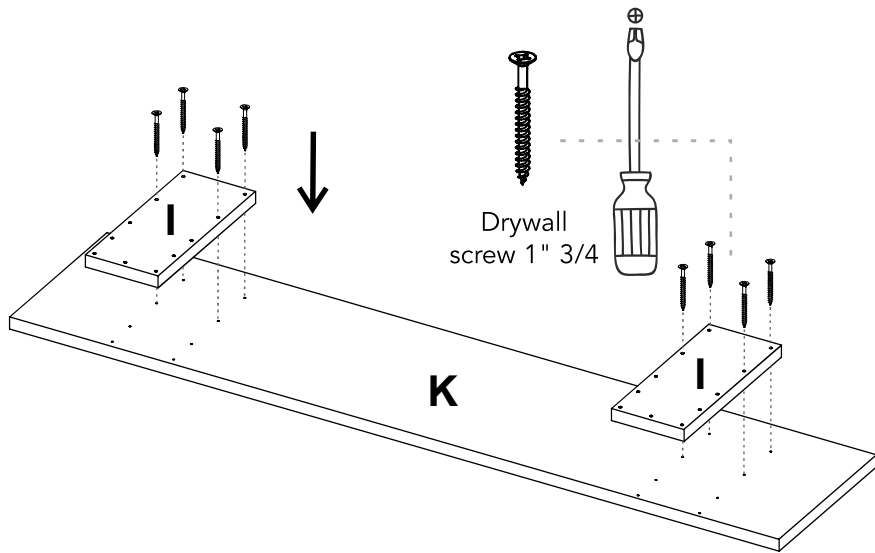

14

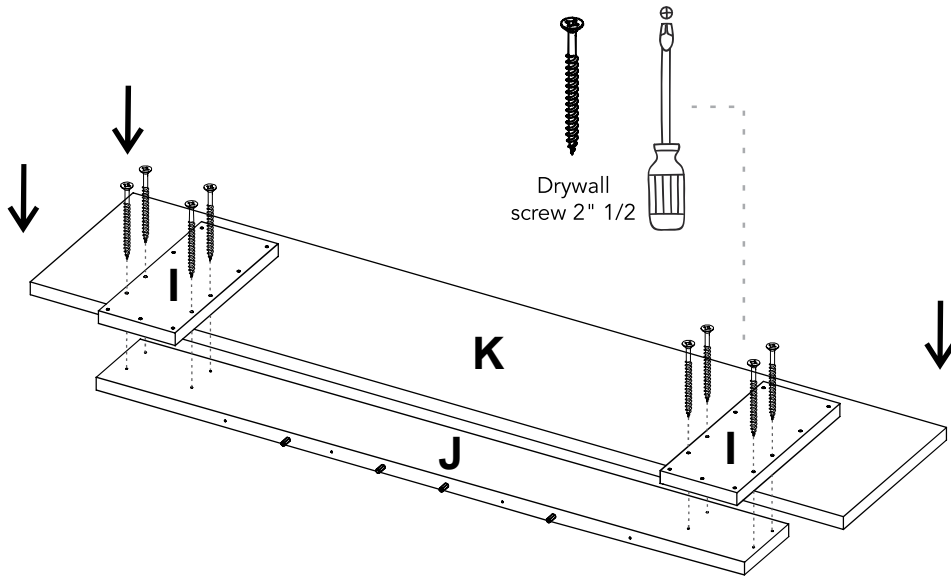

15

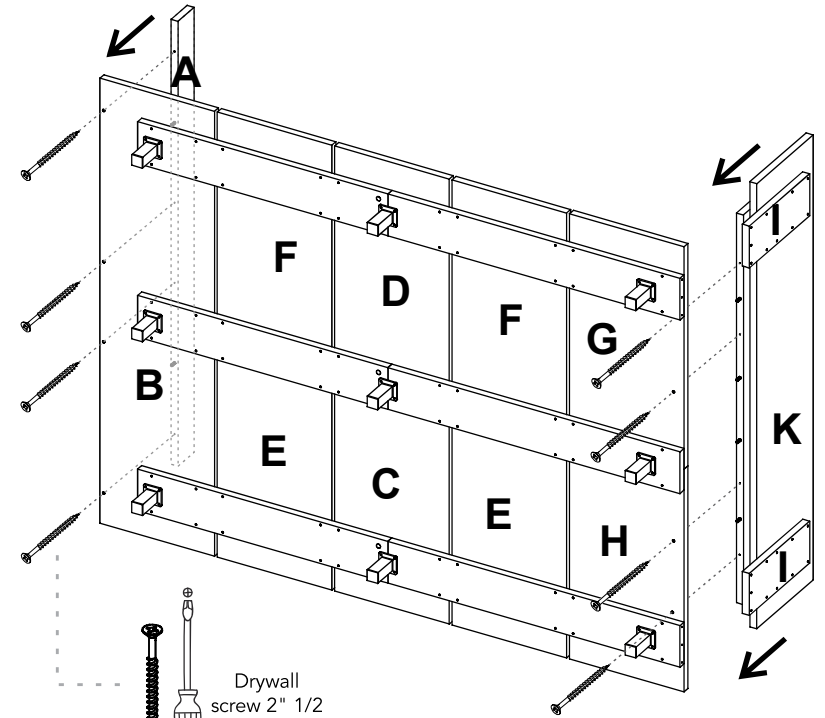

16

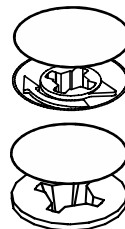
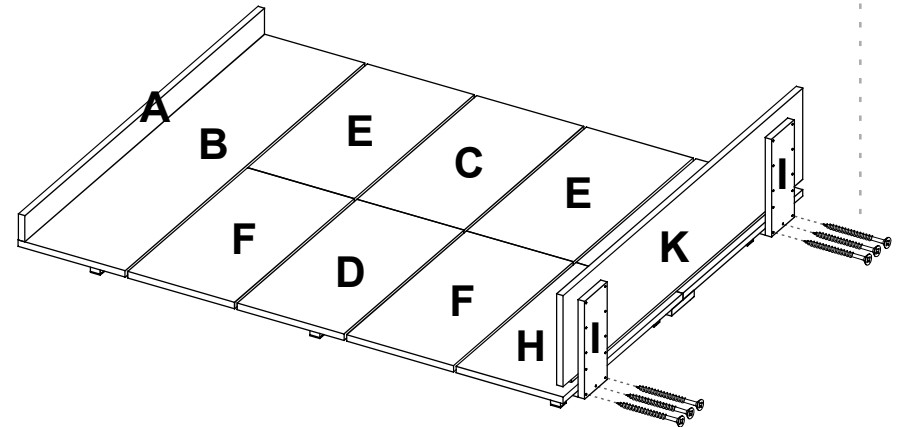

Después de ajustar todas las cajas minifix y los tornillos, cúbralas con las tapas adhesivas.
 After you finish the adjustment of the cams and screws, cover them with the cover caps.

A

Al terminar de armar, desprenda las letras adhesivas.
 After you finish assembling the cabinet, take off the adhesive letters.