

10

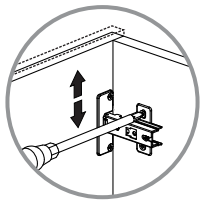

AJUSTE DE ALTURA
/ HEIGHT
ADJUSTMENT

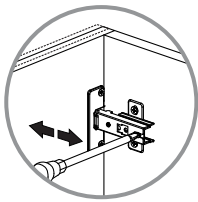

AJUSTE DE PROFUNDIDAD
/ DEPTH
ADJUSTMENT

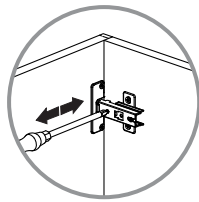

AJUSTE LATERAL
/ LATERAL
ADJUSTMENT

INSTALACIÓN BISAGRAS
aplica para todas las puertas

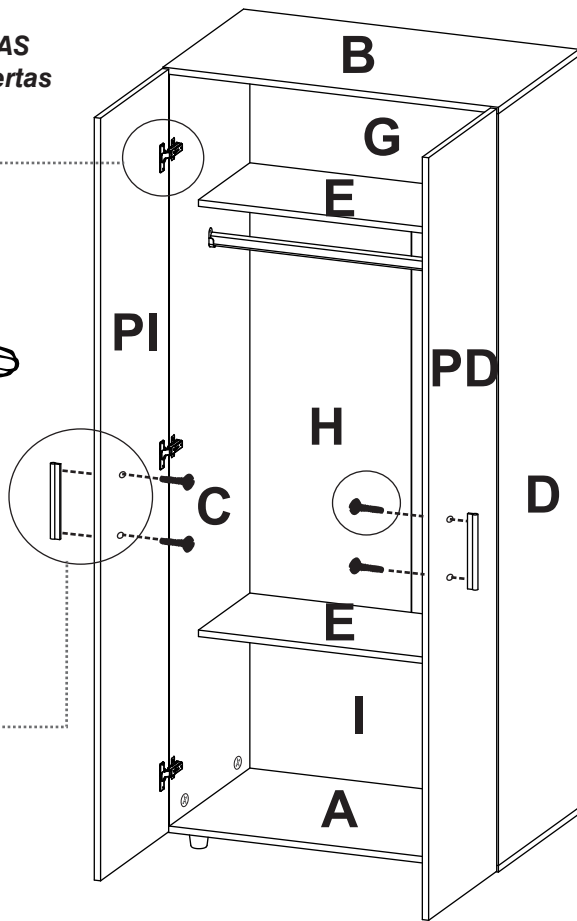
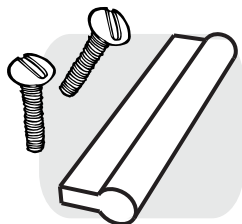
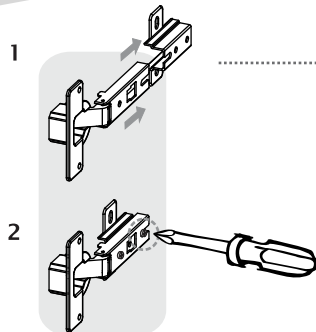

Al finalizar el ajuste, cubra las cajas con las tapas adhesivas/ After tightening all the panels, cover the minifix cams with the adhesive caps.



Al terminar de armar, despegue los adhesivos (en caso de que queden residuos de pegamento, limpie la superficie con alcohol) / After finishing the assembly, take off the adhesives. (In case of glue residues, wipe them with alcohol)

RTA
muebles

INSTRUCCIONES DE ENSAMBLE
ASSEMBLY INSTRUCTIONS

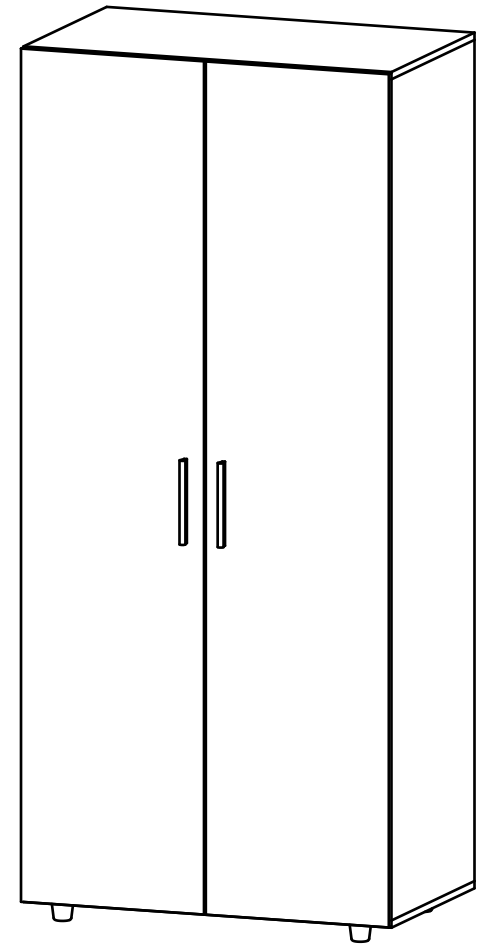

Alto/ Height: 180,5 cm / 71,1 in
Ancho/ Width: 80 cm / 31,5 in
Fondol/ Depth: 48,5 cm / 19,1 in

LOTE No: _____

REF./SKU.

By: **RTA**
muebles
TEL (572) 691 17 00
PBX (572) 695 91 81
CALI - COLOMBIA
www.rta.com.co

CLÓSET HOGAR
/Hogar Wardrobe

RECOMENDACIONES IMPORTANTES KEY RECOMMENDATIONS

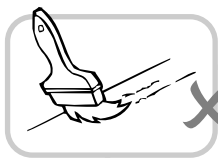

NO pinte el mueble /
Do not paint the
furniture.



NO mojar o ubicar
a la intemperie /
Do not expose to rain
or direct sun.

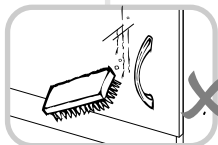
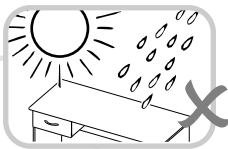

NO lavar las manijas o
tiraderas con jabones o
elementos abrasivos /
Do not wash handles or
dumps with soap or
abrasives.

NO sobrecargue el mueble.
no exceda el peso de 30 kilos
para gabinetes de cocina /
Do not overload the cabinet.
Weight max. 66lbs
for kitchen cabinets.

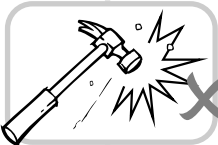

NO golpear ni martillar
el mueble (hágalo sólo
donde se indique) /
Do not hit or hammer
the furniture (just do it
where is indicated).

NO permita que los niños
manipulen el mueble, puede
voltearse y lastimarlos /
Do not allow children to
handle the cabinets or
drawers, they could get hurt.

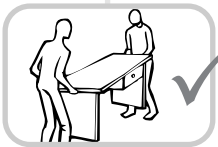

SIEMPRE levante el
mueble entre dos
personas, NO lo arrastre /
Do not drag the furniture.
Lift it between two people.

Limpie con paño seco,
/ Clean with a dry cloth.



HERRAJES BÁSICOS PARA MUEBLES RTA BASIC HARDWARE FOR RTA FURNITURE

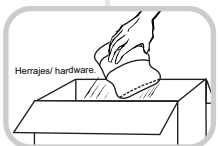

1. Abrir la caja del mueble
y buscar la bolsa con los
herrajes / Open the box
and look for the hardware
bag.

3. Separe los herrajes para
facilitar su identificación
durante el armado /
Separate hardware for easy
identification during
assembly.

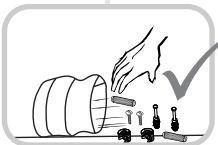
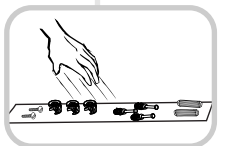

2. Abrir el paquete y
comprobar que el
contenido de las piezas es
correcto / Open the
package and verify that
the content of the pieces
is correct.

4. Arme el mueble en un
lugar limpio y en una
superficie plana / RTA
furniture must be assembled
in a clean place and on a flat
surface.

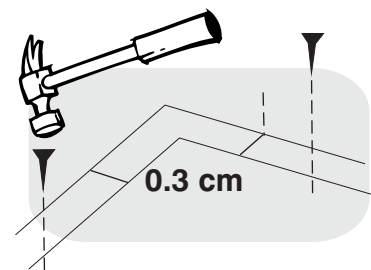
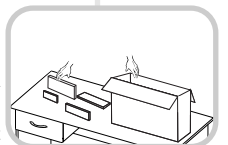

VOLTEAR/
TURN OVER

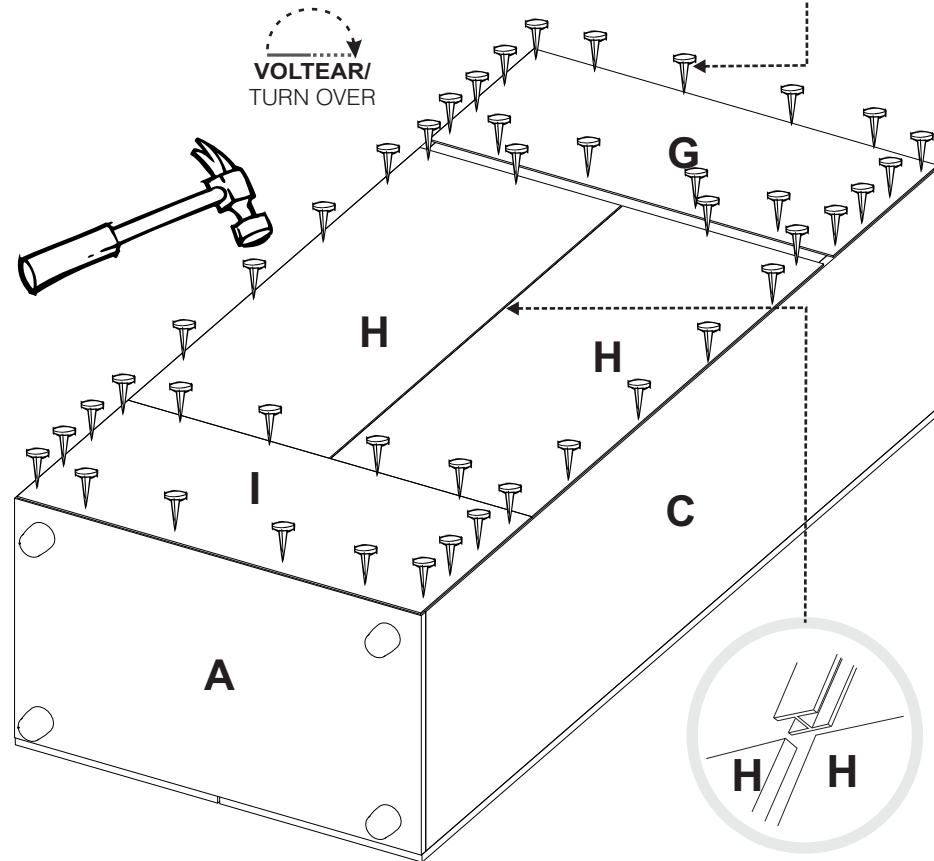

7

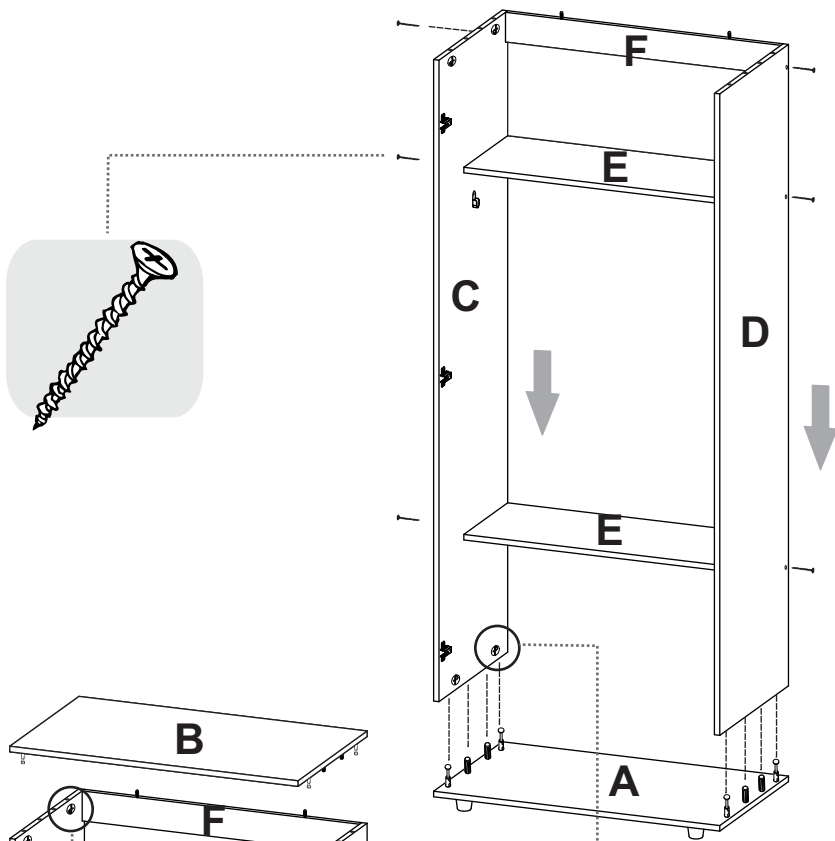

8

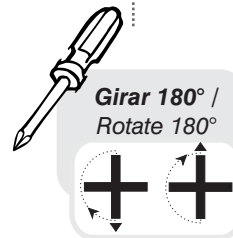
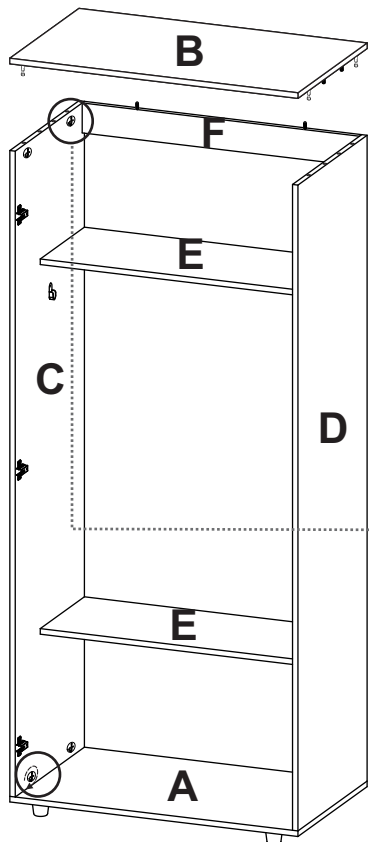

RECOMENDACIONES DE ENSAMBLE / ASSEMBLY RECOMMENDATIONS

El buen funcionamiento del mueble depende de un adecuado ensamblaje
An excellent furniture's performance relies on a solid and a suitable assembly.

MINIFIX / CONNECTOR - DOWELS

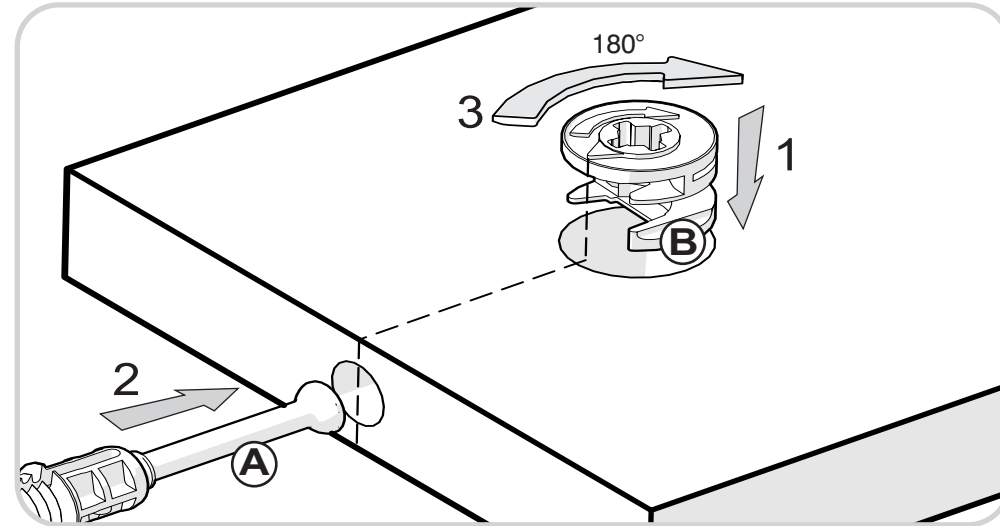

Sistema de unión compuesto por un perno (A) y una caja minifix (B).

(1) Se inserta la caja minifix dentro de la perforación ubicada en la cara de la pieza, la flecha debe apuntar siempre a la dirección de la perforación por donde entrará el perno.

(2) Se debe insertar el perno por su parte plástica en las perforaciones que se indiquen, luego se inserta la punta metálica en la perforación para que su cabeza quede al interior de la caja minifix.

(3) Girar la caja minifix 180° para apretar las dos piezas.

It's a fitting system made of a spreading bolt (A) and a minifix cam (B).

(1) Insert the minifix cam in the hole placed in the face of the panel with the arrow pointing towards the hole where the bolt will fit.

(2) Insert the bolt with its plastic base in the shown holes, then insert the metallic bolt head in the holes so it fits inside the minifix cam.

(3) Tight the panels by turning the minifix cam 180°.

TARUGOS O TAQUETES / FLUTED DOWEL PIN

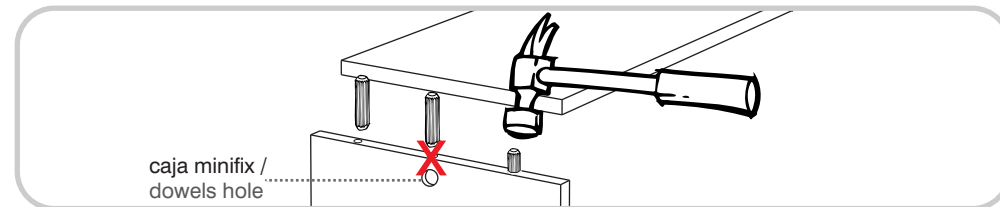

Es un pedazo de madera corto y grueso, de aproximadamente 5 a 10 cm de largo, que sirve para amarrar el mueble y darle resistencia.

It's a short and thick piece of wood, 1,9 to 3,9 inches approximately, which is used to tie the cabinet and give it resistance.

HERRAJES PARA ARMADO ASSEMBLY HARDWARE

5

x8



Minifix/
Minifix Cams

x8

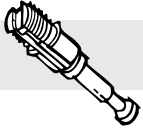

Perno minifix/
Spreading Bolt

x28

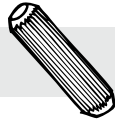

Tarugo/
Fluted Dowel Pin

x4



Tornillo Lámina/
Sheet Screw

x8



Tapa Adhesiva
Minifix/
Cover Caps

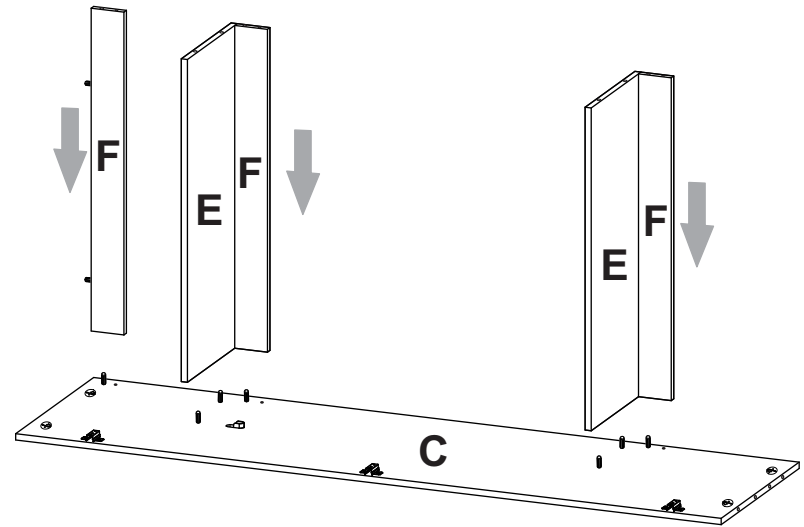

x2



Soporte Tubo
Ovalado/
Closet Rod
Support

x1

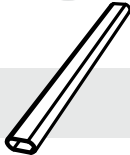

Tubo Ovalado/
Closet Rod

x1

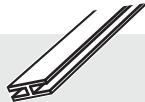

Perfil en H/
H Profile

x2

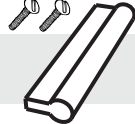

Manija/
Handle
(Include tornillos)

x60



Puntillas/
Nails

x6



Tornillo Ensamble/
Drywall Screw

x6

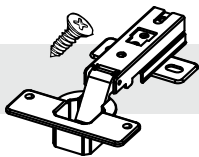

Bisagra Parche/
Full Overlay Hinge
(Include tornillos)

x4

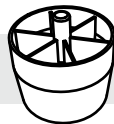

Deslizador/
Plastic Leg



TENER PRECAUCIÓN AL ABRIR LA BOLSA DE HERRAJES PARA NO EXTRAVIAR NINGUNO. COMPRUEBE QUE EL CONTENIDO DE LAS PIEZAS SEA EL CORRECTO. EN CASO QUE FALTE ALGUNA PIEZA O ESTÉ DEFECTUOSA DEVUELVA LAS PIEZAS AL ALMACÉN CON SU FACTURA PARA EFECTUAR EL CAMBIO DE LAS PIEZAS Y/O LOS HERRAJES LO MÁS PRONTO POSIBLE. / PLEASE BE CAUTIOUS WHEN OPENING THE HARDWARE BAG TO NOT LOSE ANY. CHECK THE CONTENTS OF THE PARTS ARE CORRECT. IF ANY PART IS MISSING OR IMPERFECT PLEASE RETURN THE PARTS TO THE STORE WITH THE PRODUCT INVOICE ATTACHED TO MAKE EFFECTIVE THE REPLACEMENT OF THE IMPERFECT PIECES OR HARDWARE AS SOON AS POSSIBLE.

6

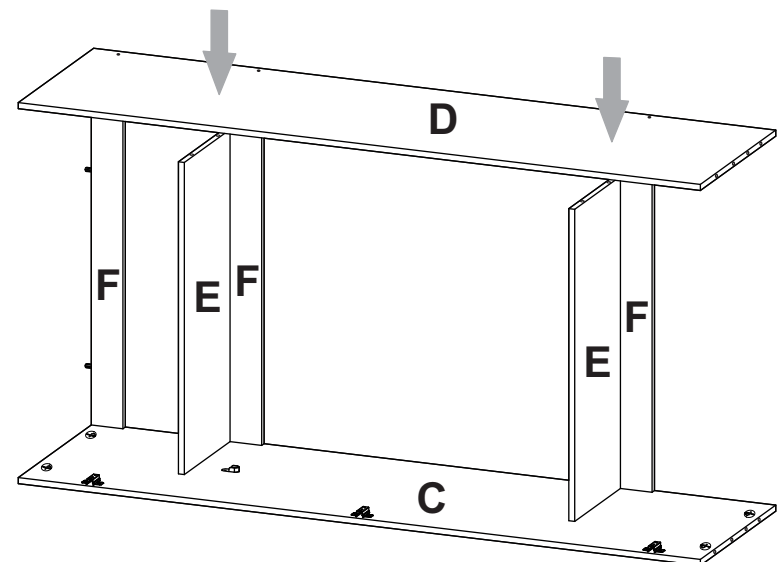

3

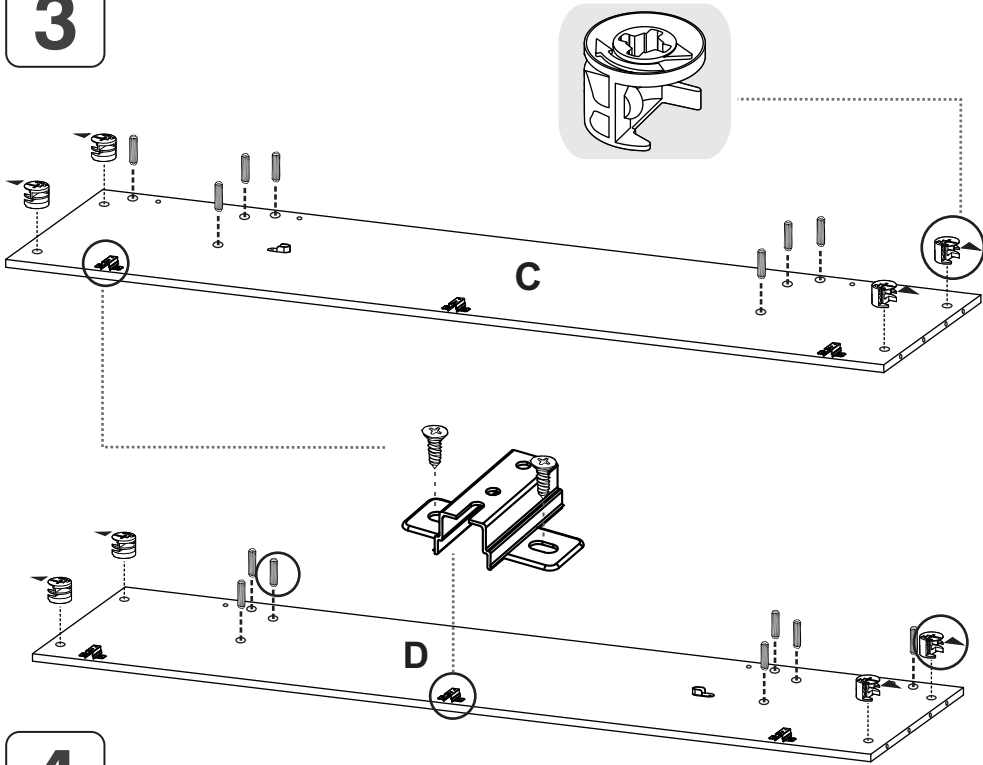

4

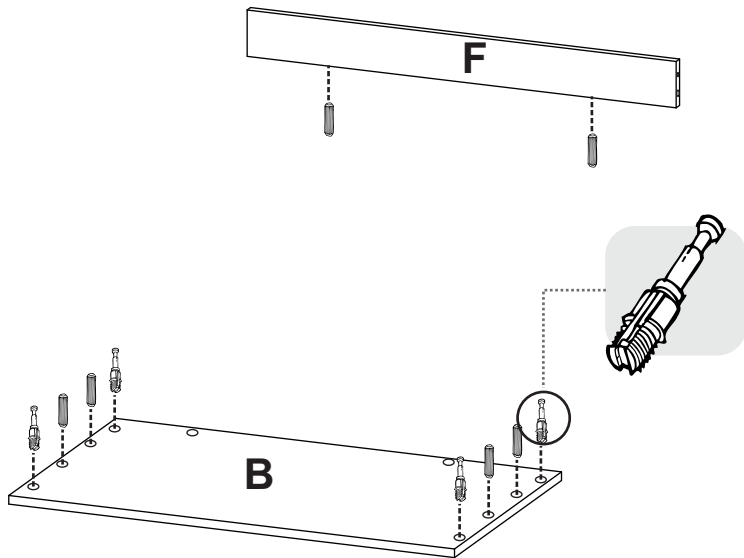

PIEZAS DE ARMADO
ASSEMBLY PARTS

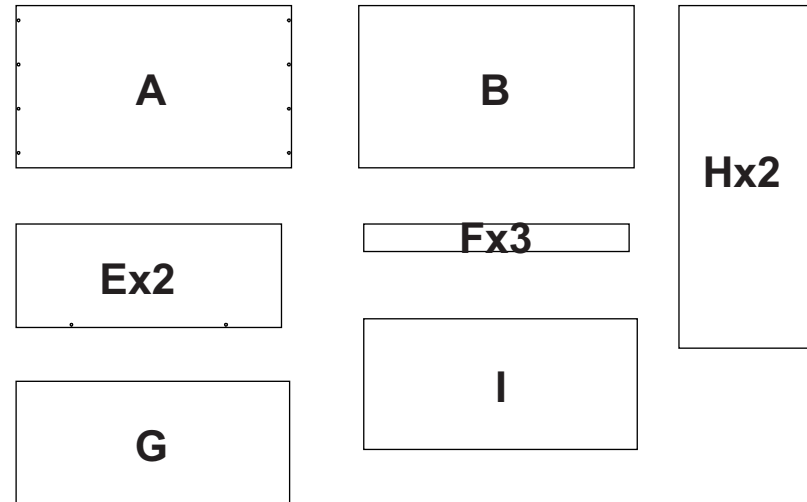
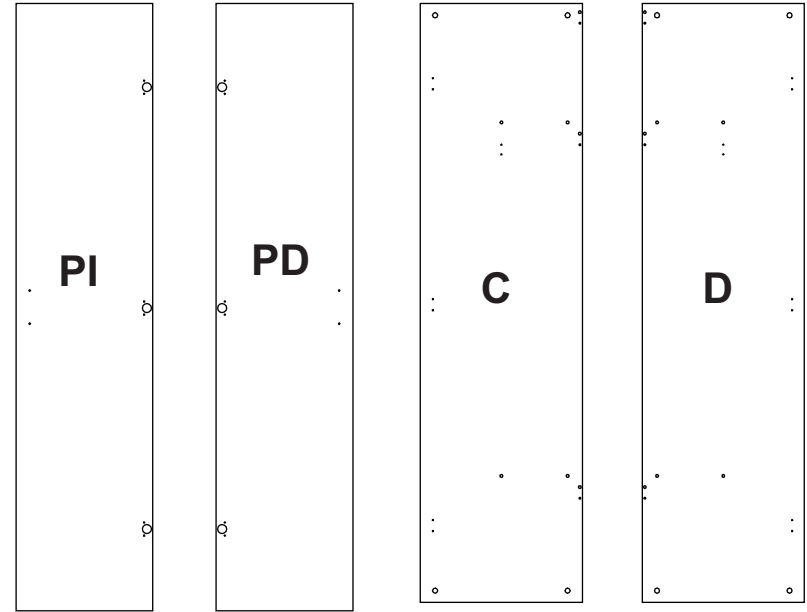

ANTES DE EMPEZAR A ARMAR EL MUEBLE LEA DETENIDAMENTE LAS INSTRUCCIONES. SE RECOMIENDA ARMAR EL MUEBLE SOBRE LA CAJA O SOBRE UNA SUPERFICIE LISA Y CUBIERTA, PARA NO RAYARLO / BEFORE STARTING TO ASSEMBLE THE CABINET, CAREFULLY READ THE INSTRUCTIONS. IT'S RECOMMENDED TO ASSEMBLE THE CABINET ON THE BOX OR ON A FLAT AND COVERED SURFACE IN ORDER TO NOT SCRATCH THE PRODUCT.

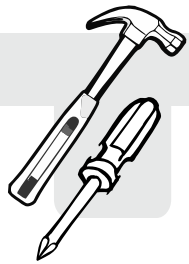

*(Herramientas NO incluidas) *Tools NOT Included

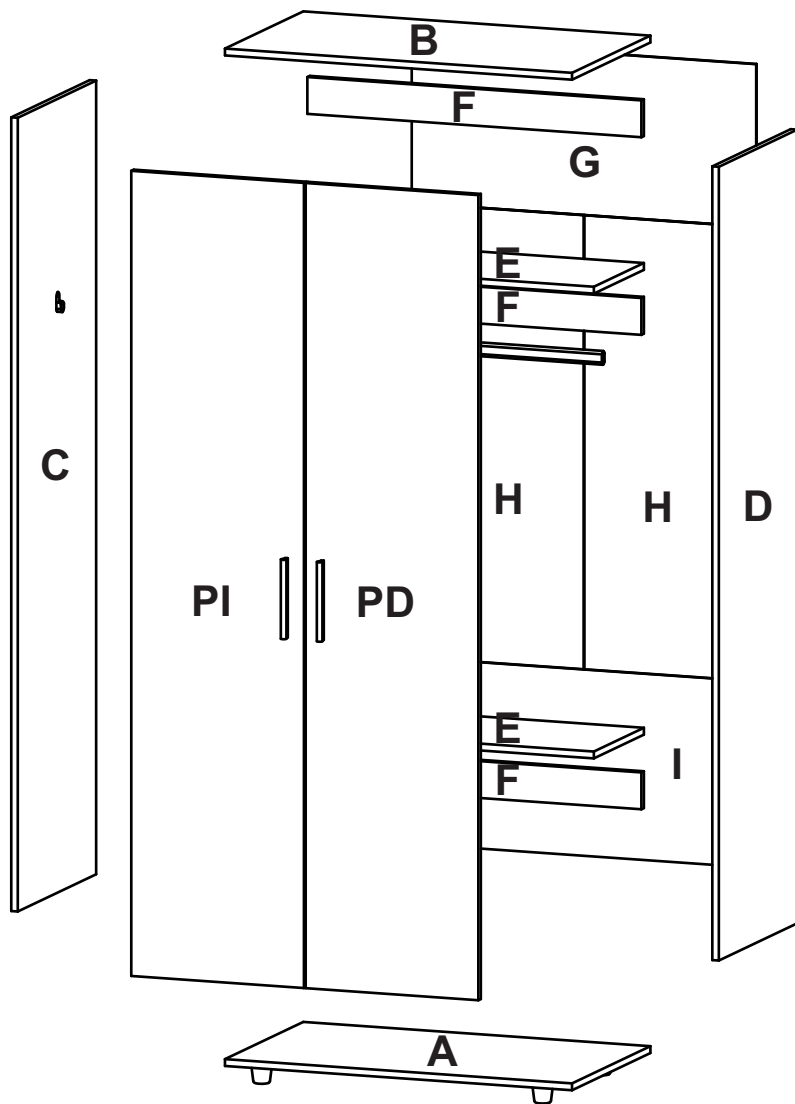

1

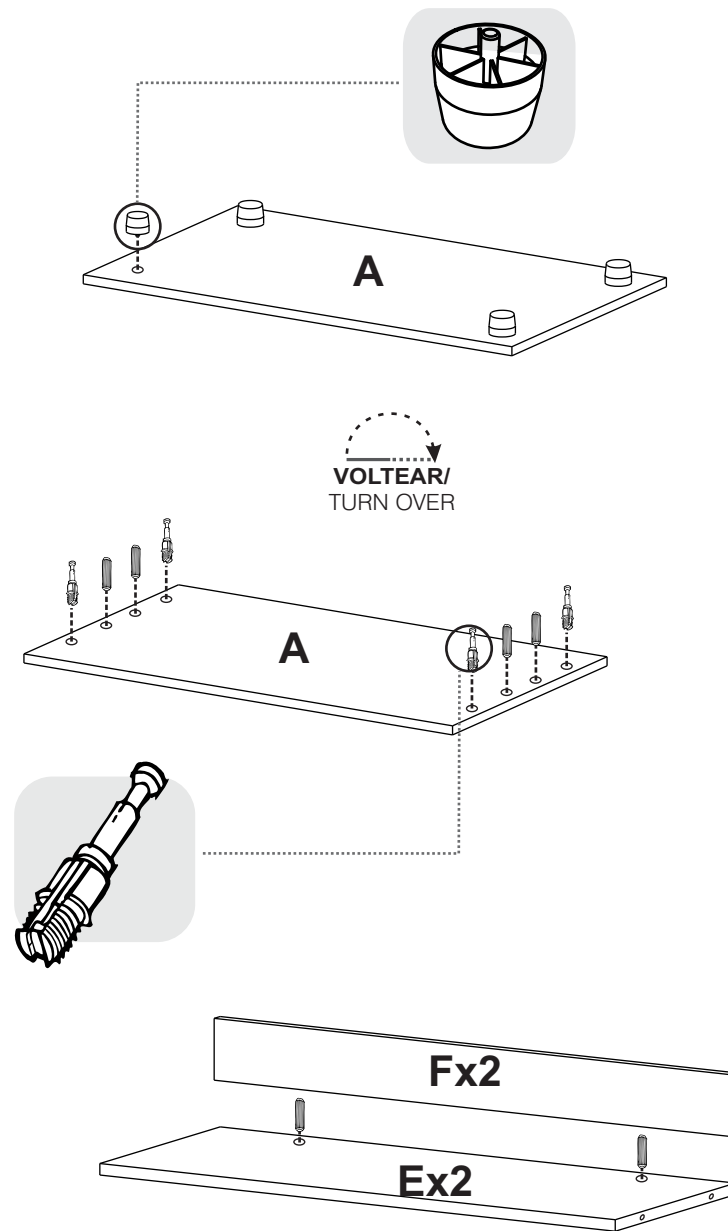

2