

20

INSTALACIÓN PUERTA DE VIDRIO/
Glass Door Installation

BISAGRA VIDRIO/
Glass Hinge

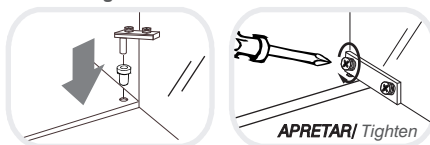

MANIJA/Handle

PEGAR CINTA/
Stick Tape

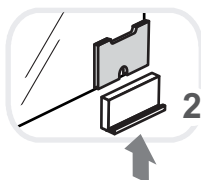
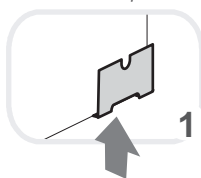

ENCAJAR LA MANIJA A PRESIÓN/
Put the handle with some pressure

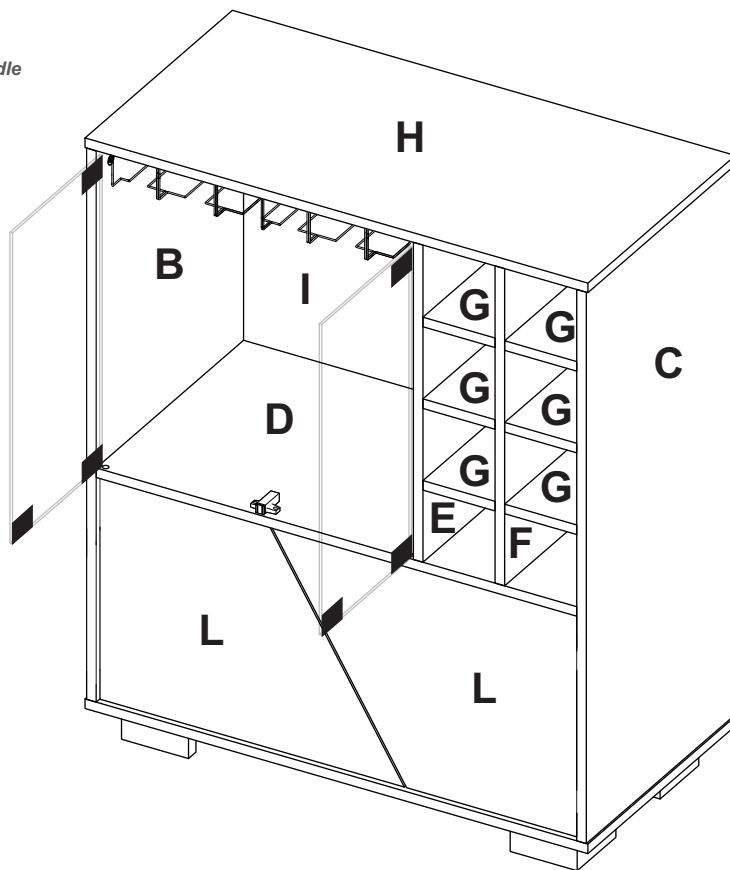

RTA® INSTRUCCIONES DE ENSAMBLE
ASSEMBLY INSTRUCTIONS
m u e b l e s

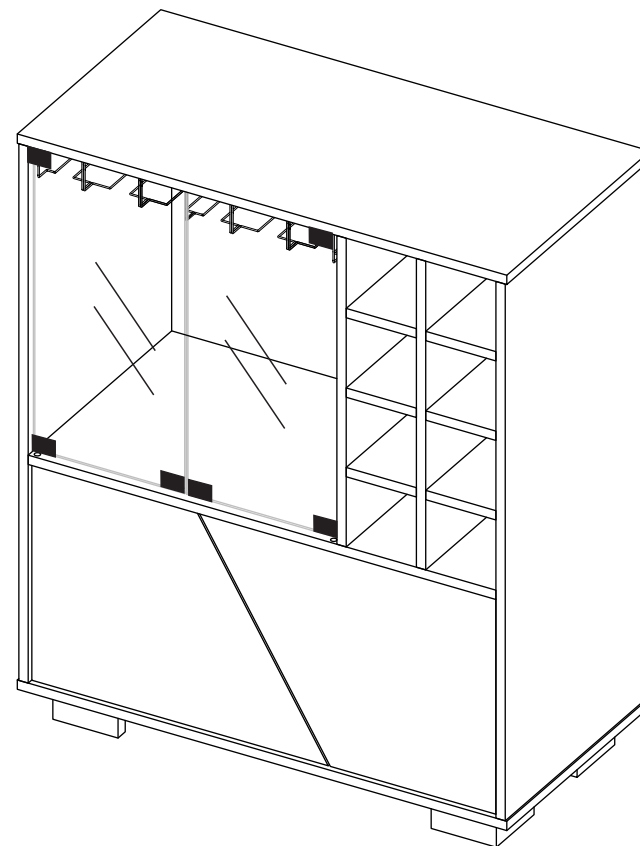

Alto/ Height: 94,9 cm / 37,36 in
Ancho/ Width: 78,8 cm / 31,02 in
Fondo/ Depth: 40,3 cm / 15,86 in

LOTE No: _____



Al finalizar el ajuste, cubra las cajas con las tapas adhesivas/ After tightening all the panels, cover the minifix cams with the adhesive caps.



Al terminar de armar, despegue los adhesivos (en caso de que queden residuos de pegamento, limpie la superficie con alcohol) / After finishing the assembly, take off the adhesives. (In case of glue residues, wipe them with alcohol)

By: **RTA®** m u e b l e s
TEL (572) 691 17 00
PBX (572) 695 91 81
CALI - COLOMBIA
www.rta.com.co

BAR FRAKTAL
/Fraktal Bar Cabinet

RECOMENDACIONES IMPORTANTES KEY RECOMMENDATIONS

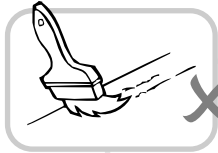

NO pinte el mueble /
Do not paint the
furniture.



NO mojar o ubicar
a la intemperie /
Do not expose to rain
or direct sun.

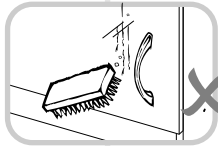
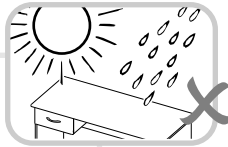

NO lavar las manijas o
tiraderas con jabones o
elementos abrasivos /
Do not wash handles or
dumps with soap or
abrasives.

NO sobrecargue el mueble.
no exceda el peso de 30 kilos
para gabinetes de cocina /
Do not overload the cabinet.
Weight max. 66lbs
for kitchen cabinets.

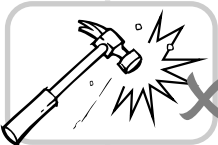

NO golpear ni martillar
el mueble (hágalo sólo
donde se indique) /
Do not hit or hammer
the furniture (just do it
where is indicated).

NO permita que los niños
manipulen el mueble, puede
voltearse y lastimarlos /
Do not allow children to
handle the cabinets or
drawers, they could get hurt.

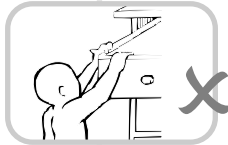

SIEMPRE levante el
mueble entre dos
personas, NO lo arrastre /
Do not drag the furniture.
Lift it between two people.

Limpie con paño seco,
/ Clean with a dry cloth.



HERRAJES BÁSICOS PARA MUEBLES RTA BASIC HARDWARE FOR RTA FURNITURE

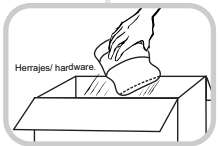

1. Abrir la caja del mueble
y buscar la bolsa con los
herrajes / Open the box
and look for the hardware
bag.

3. Separe los herrajes para
facilitar su identificación
durante el armado /
Separate hardware for easy
identification during
assembly.

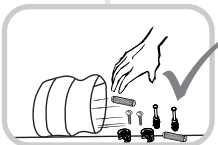
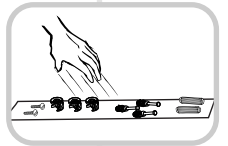

2. Abrir el paquete y
comprobar que el
contenido de las piezas es
correcto / Open the
package and verify that
the content of the pieces
is correct.

4. Arme el mueble en un lugar
limpio y en una superficie
plana / RTA furniture
must be assembled
in a clean place and on
a flat surface.

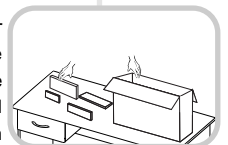

INSTALACIÓN DE LAS PUERTAS DOOR INSTALLATION

19

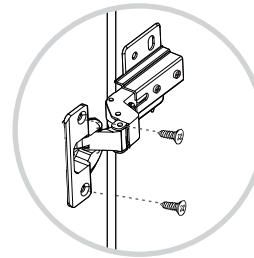

Bisagra interior/
Inset hinge

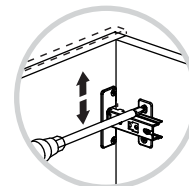
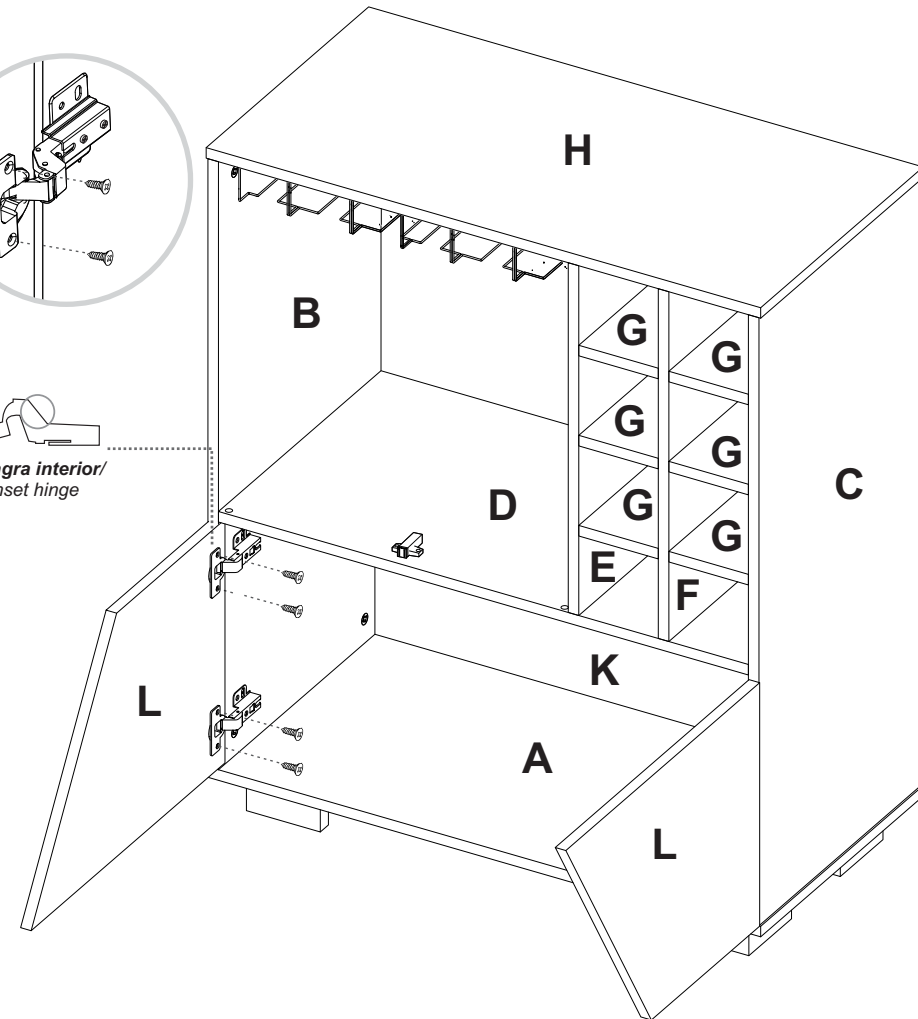

AJUSTE DE ALTURA
/ HEIGHT
ADJUSTMENT

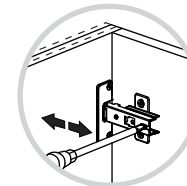

AJUSTE DE PROFUNDIDAD
/ DEPTH
ADJUSTMENT

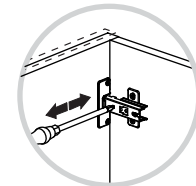

AJUSTE LATERAL
/ LATERAL
ADJUSTMENT

18

Voltear el mueble cuidadosamente para ensamblar el fondo/
Be careful turning over the cabinet



Puntillas/
Nails

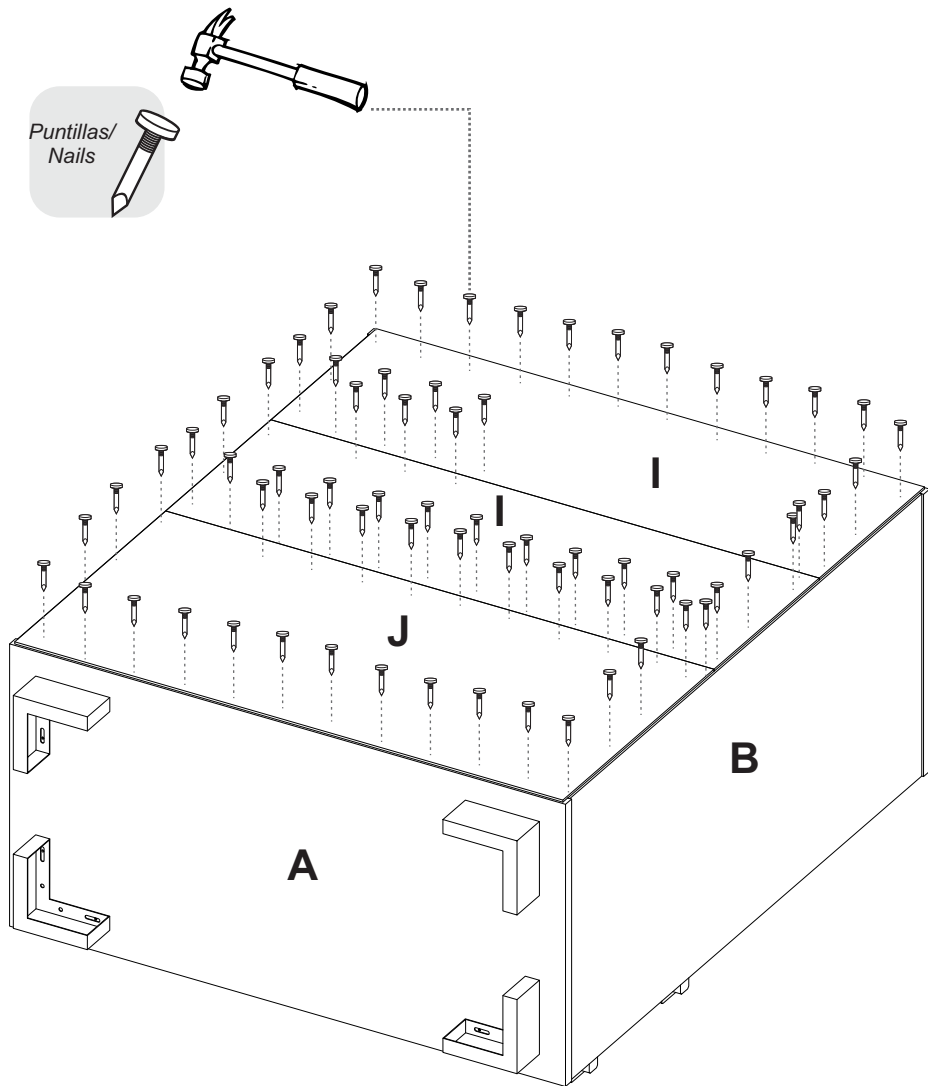

RECOMENDACIONES DE ENSAMBLE / ASSEMBLY RECOMMENDATIONS

El buen funcionamiento del mueble depende de un adecuado ensamblaje
An excellent furniture's performance relies on a solid and a suitable assembly.

MINIFIX / CONNECTOR - DOWELS

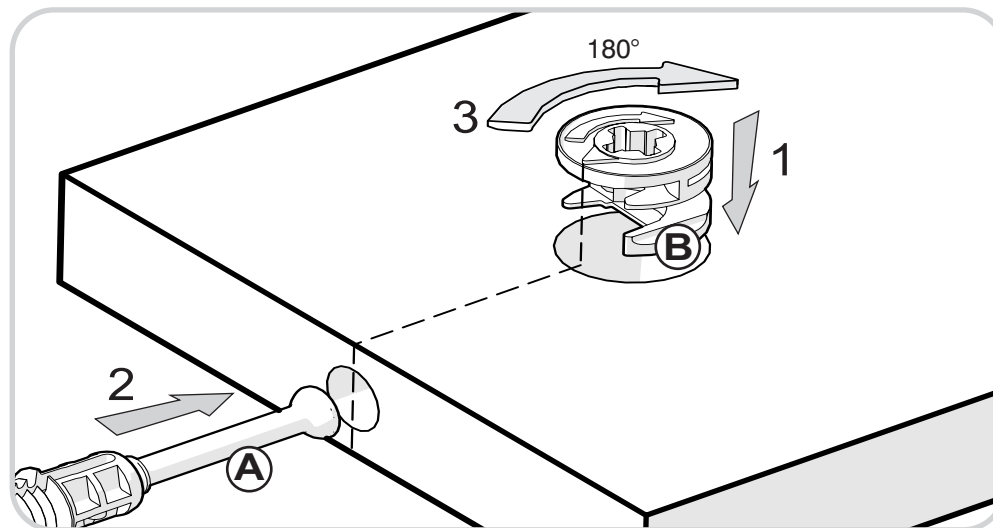

Sistema de unión compuesto por un perno (A) y una caja minifix (B).

(1) Se inserta la caja minifix dentro de la perforación ubicada en la cara de la pieza, la flecha debe apuntar siempre a la dirección de la perforación por donde entrará el perno.

(2) Se debe insertar el perno por su parte plástica en las perforaciones que se indiquen, luego se inserta la punta metálica en la perforación para que su cabeza quede al interior de la caja minifix.

(3) Girar la caja minifix 180° para apretar las dos piezas.

It's a fitting system made of a spreading bolt (A) and a minifix cam (B).

(1) Insert the minifix cam in the hole placed in the face of the panel with the arrow pointing towards the hole where the bolt will fit.

(2) Insert the bolt with its plastic base in the shown holes, then insert the metallic bolt head in the holes so it fits inside the minifix cam.

(3) Tight the panels by turning the minifix cam 180°.

TARUGOS O TAQUETES / FLUTED DOWEL PIN

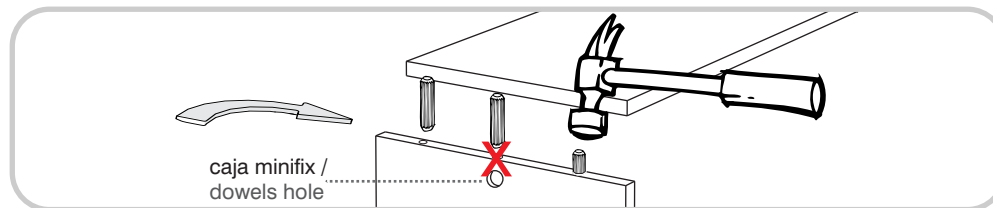

Es un pedazo de madera corto y grueso, de aproximadamente 3 a 10 cm de largo, que sirve para amarrar el mueble y darle resistencia.

It's a short and thick piece of wood, 1,2 to 3,9 inches approximately, which is used to tie the cabinet and give it resistance.

RECOMENDACIONES IMPORTANTES / KEY RECOMMENDATIONS

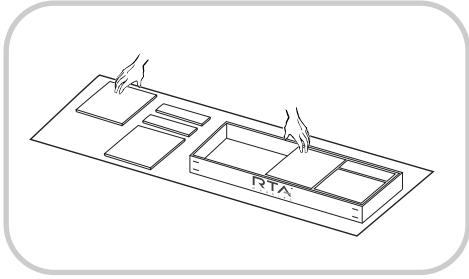

Se recomienda armar el mueble sobre la caja o una superficie lisa para no rayarlo. It is recommended to assemble the product on the box or on a flat surface to not scratch it.

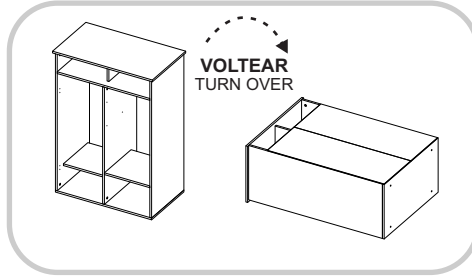

Voltear el mueble cuidadosamente para ensamblar los fondos. Carefully turn over the cabinet to assemble the back panels.

PESO MAX. SUGERIDO EN MUEBLE (Kg) / MAX SUGGESTED LOAD (Kg)

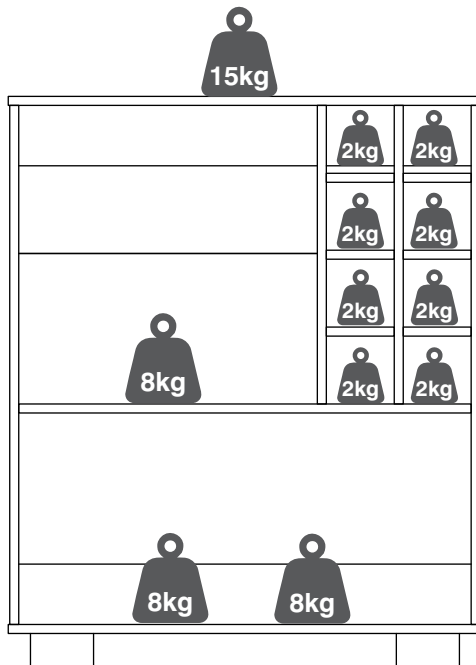

NOTA: La resistencia a las cargas puede variar dependiendo si es una carga distribuida o una carga puntual, las gráficas corresponden a cargas puntuales, NO exceder los pesos sugeridos / **NOTE:** The load capacity depends if it is a *point load* or if it is a *uniform distributed load*, do not exceed the suggested loads.

17

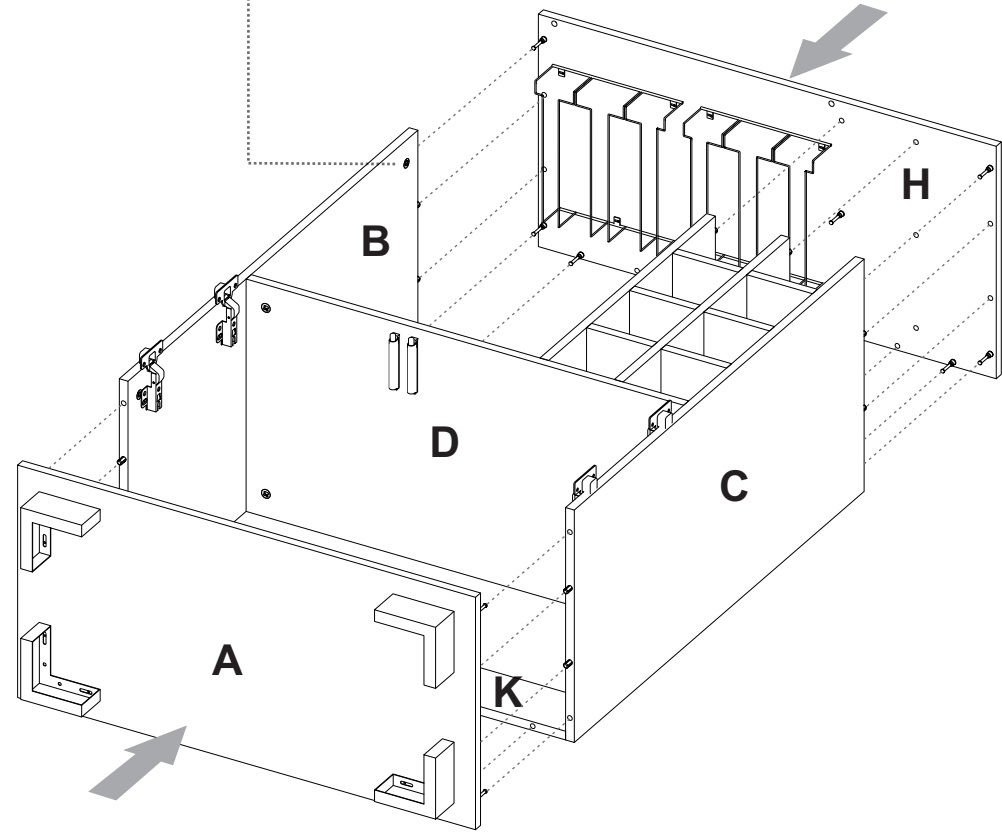
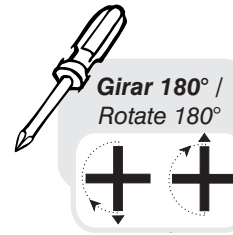

15

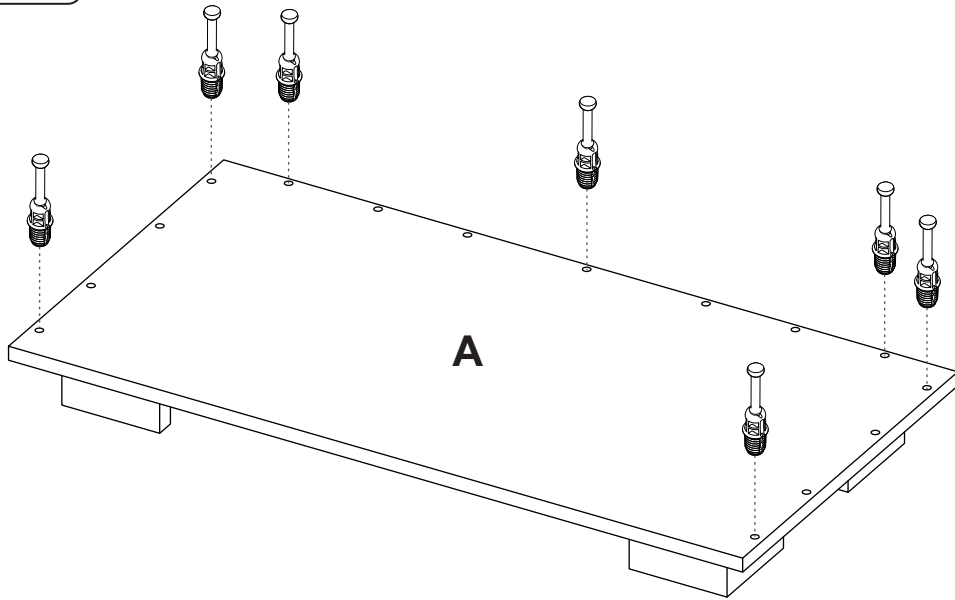

16

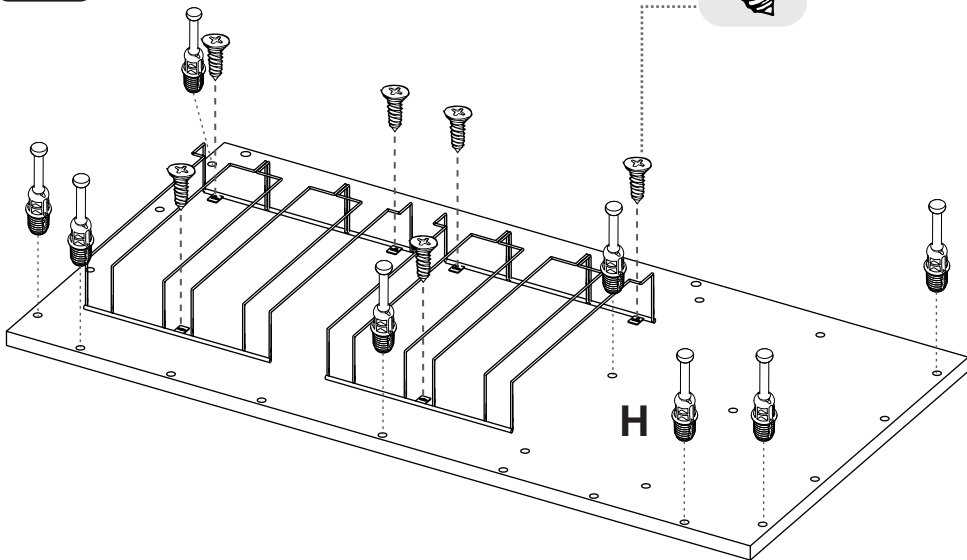

Tornillo lámina
6 X 9/16"
Sheet Metal Screw

HERRAJES PARA ARMADO ASSEMBLY HARDWARE

x82

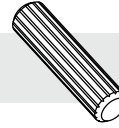

Tarugo/
Fluted Dowel Pin

x24

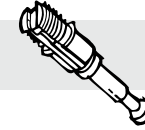

Perno minifix/
Spreading Bolt

x24



Minifix/
Minifix Cams

x24



Tapa Adhesiva
Minifix /
Cover Caps

x4

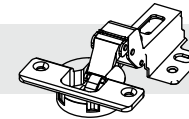

Bisagra interna/
Inset Hinge

x2

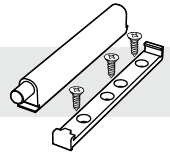

Sistema Push/
Push to Open
Incluye Tornillos

x4

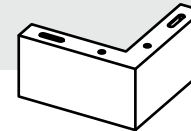

Patas en acero /
steel legs

x2

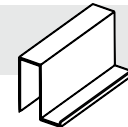

Tiradera Metálica
/Metallic Handle



TENER PRECAUCIÓN AL ABRIR LA BOLSA DE HERRAJES PARA NO EXTRAVIAR NINGUNO. COMPRUEBE QUE EL CONTENIDO DE LAS PIEZAS SEA EL CORRECTO. EN CASO QUE FALTE ALGUNA PIEZA O ESTE DEFECTUOSA DEVUELVA LAS PIEZAS AL ALMACÉN CON SU FACTURA PARA EFECTUAR EL CAMBIO DE LAS PIEZAS Y/O LOS HERRAJES LO MÁS PRONTO POSIBLE. / PLEASE BE CAUTIOUS WHEN OPENING THE HARDWARE BAG TO NOT LOSE ANY. CHECK THE CONTENTS OF THE PARTS ARE CORRECT. IF ANY PART IS MISSING OR IMPERFECT PLEASE RETURN THE PARTS TO THE STORE WITH THE PRODUCT INVOICE ATTACHED TO MAKE EFFECTIVE THE REPLACEMENT OF THE IMPERFECT PIECES OR HARDWARE AS SOON AS POSSIBLE.

HERRAJES PARA ARMADO

ASSEMBLY HARDWARE

x4

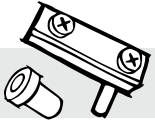

Bisagra Puerta Vidrio
/Glass Door Hinge

x2



Vidrio/
Glass

x1

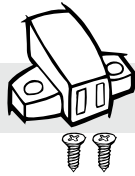

Vaivén Magnético
/Magnetic Stop

x2

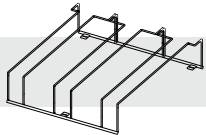

Porta Copas/
Cup Holder

x30



Tornillo Lámina/
Sheet Screw

x16

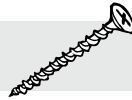

Tornillo de
ensamble 1/2"
/ Drywall screw

x68



Puntillas 1"/
Nails



TENER PRECAUCIÓN AL ABRIR LA BOLSA DE HERRAJES PARA NO EXTRAVIAR NINGUNO. COMPRUEBE QUE EL CONTENIDO DE LAS PIEZAS SEA EL CORRECTO. EN CASO QUE FALTE ALGUNA PIEZA O ESTE DEFECTUOSA DEVUELVA LAS PIEZAS AL ALMACÉN CON SU FACTURA PARA EFECTUAR EL CAMBIO DE LAS PIEZAS Y/O LOS HERRAJES LO MÁS PRONTO POSIBLE. / PLEASE BE CAUTIOUS WHEN OPENING THE HARDWARE BAG TO NOT LOSE ANY. CHECK THE CONTENTS OF THE PARTS ARE CORRECT. IF ANY PART IS MISSING OR IMPERFECT PLEASE RETURN THE PARTS TO THE STORE WITH THE PRODUCT INVOICE ATTACHED TO MAKE EFFECTIVE THE REPLACEMENT OF THE IMPERFECT PIECES OR HARDWARE AS SOON AS POSSIBLE.

13

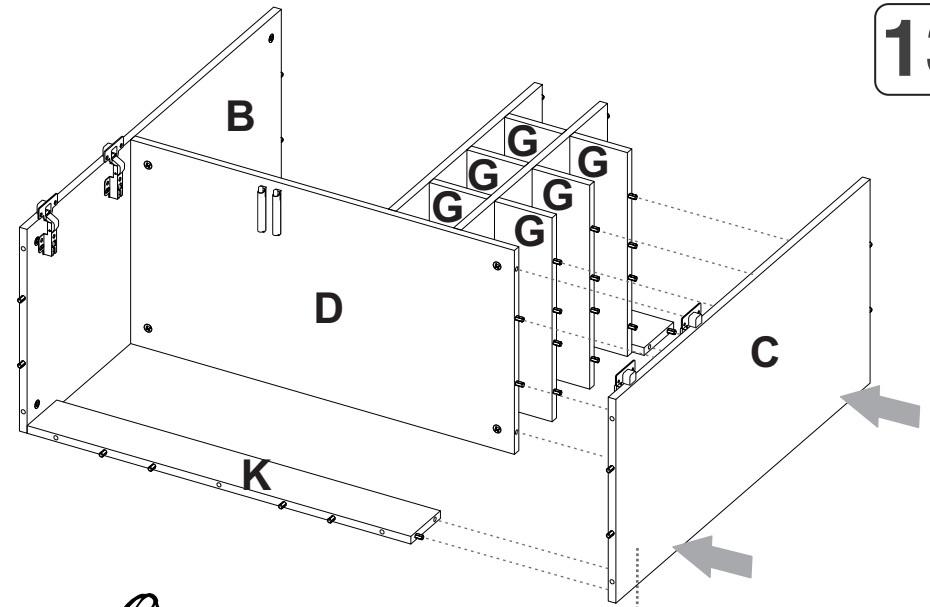

Girar 180° /
Rotate 180°

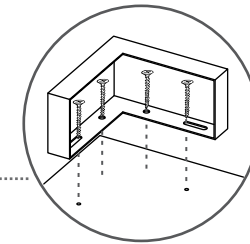
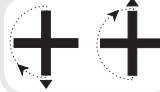

Tornillo de
ensamble 1/2"
/ Drywall screw

14

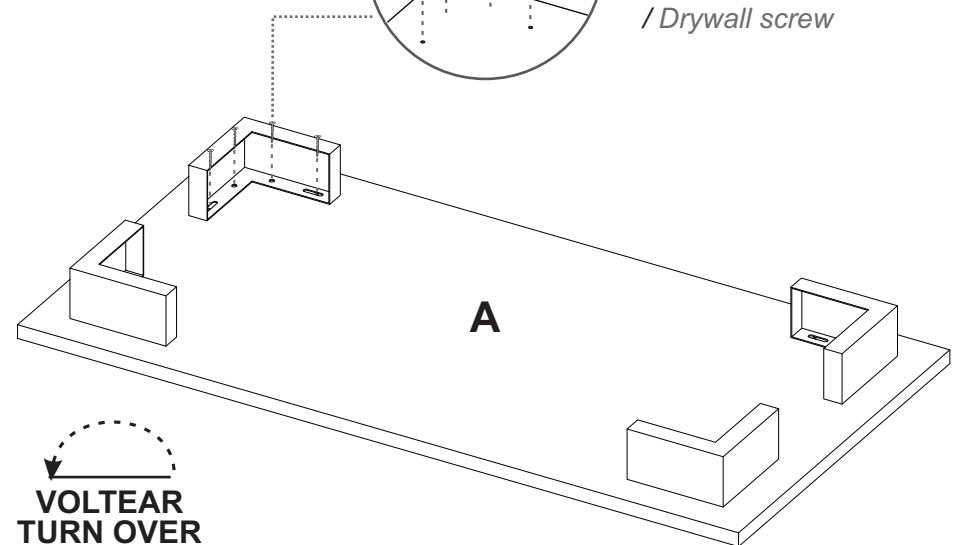

VOLTEAR
TURN OVER

11

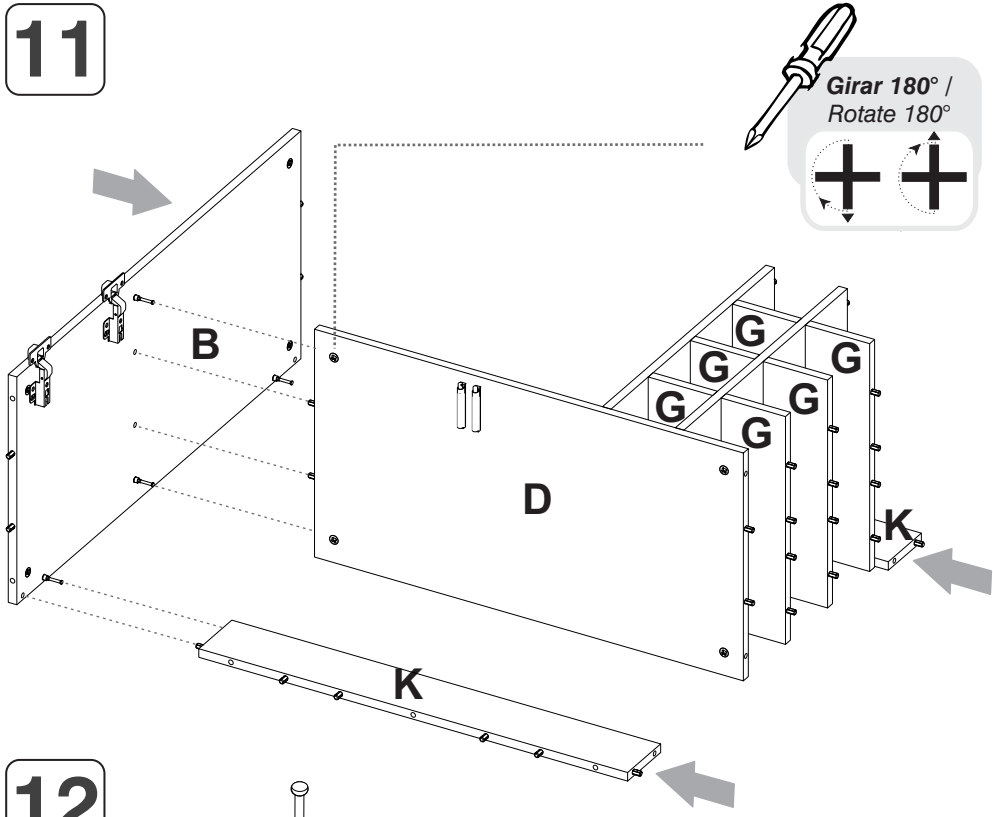

12

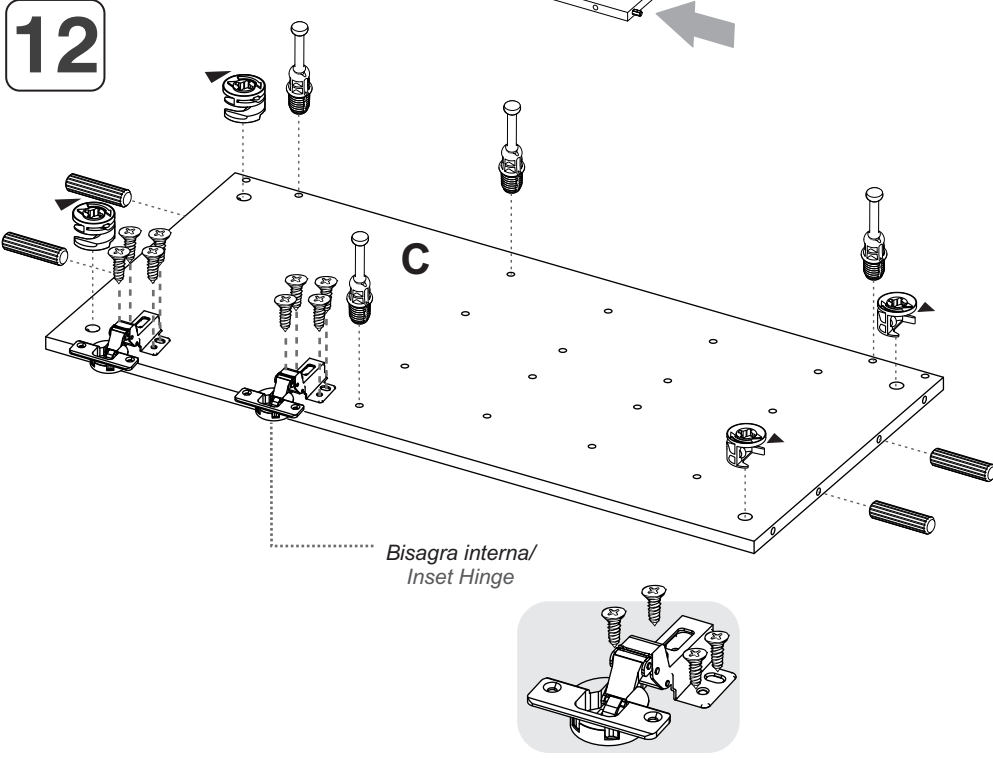

PIEZAS DE ARMADO
ASSEMBLY PARTS

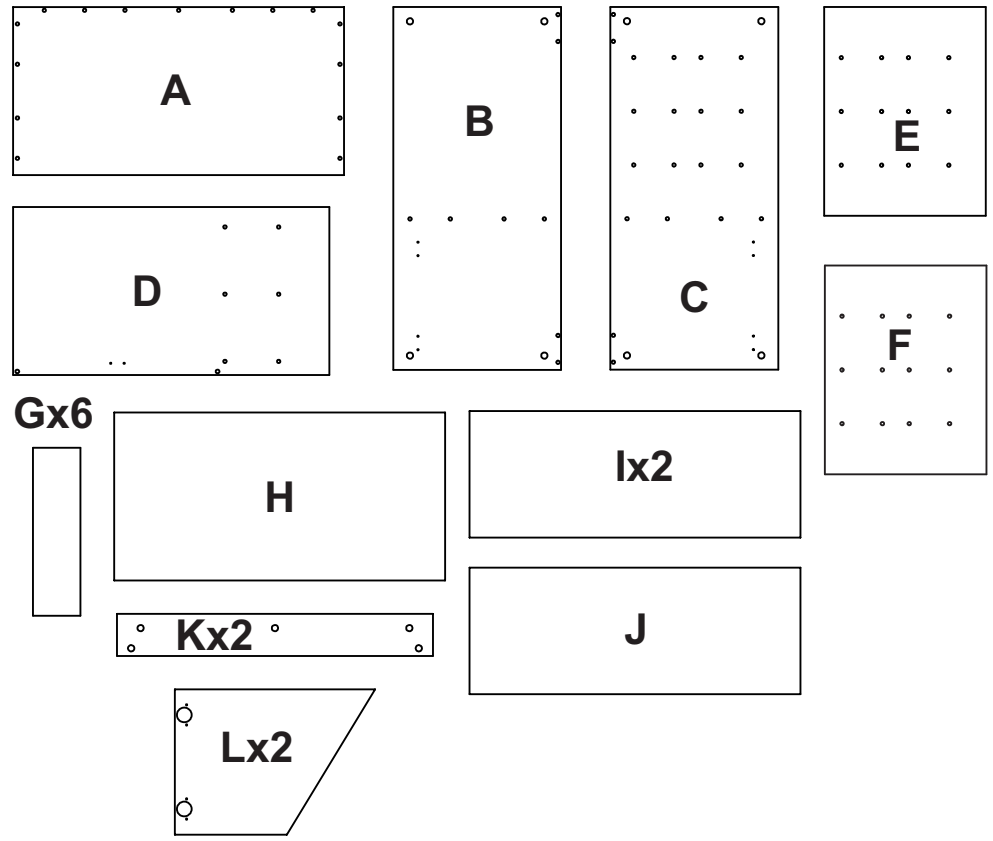

 ANTES DE EMPEZAR A ARMAR EL MUEBLE LEA DETENIDAMENTE LAS INSTRUCCIONES. SE RECOMIENDA ARMAR EL MUEBLE SOBRE LA CAJA O SOBRE UNA SUPERFICIE LISA Y CUBIERTA, PARA NO RAYARLO / BEFORE STARTING TO ASSEMBLE THE CABINET, CAREFULLY READ THE INSTRUCTIONS. IT IS RECOMMENDED TO ASSEMBLE THE FURNITURE ON THE BOX OR ON A FLAT AND COVERED SURFACE IN ORDER TO NOT SCRATCH THE PRODUCT.

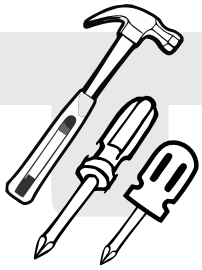

**(Herramientas NO incluidas) *Tools NOT Included*

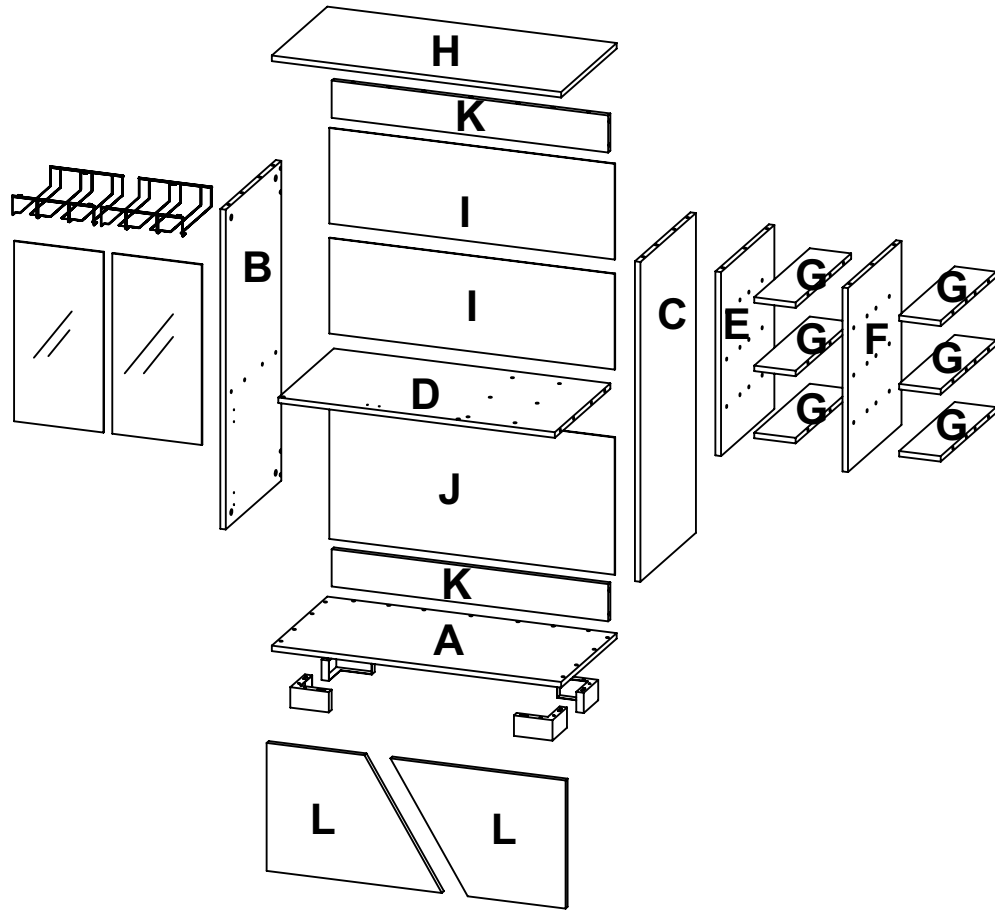

*Girar 180° /
Rotate 180°*

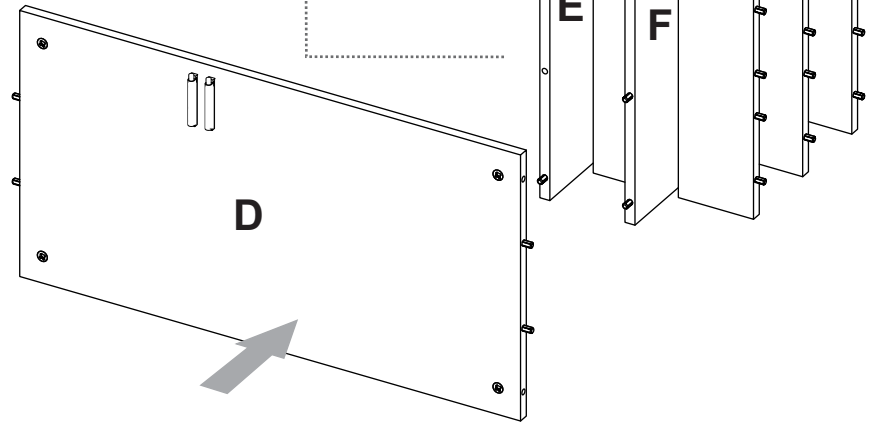
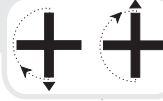

9

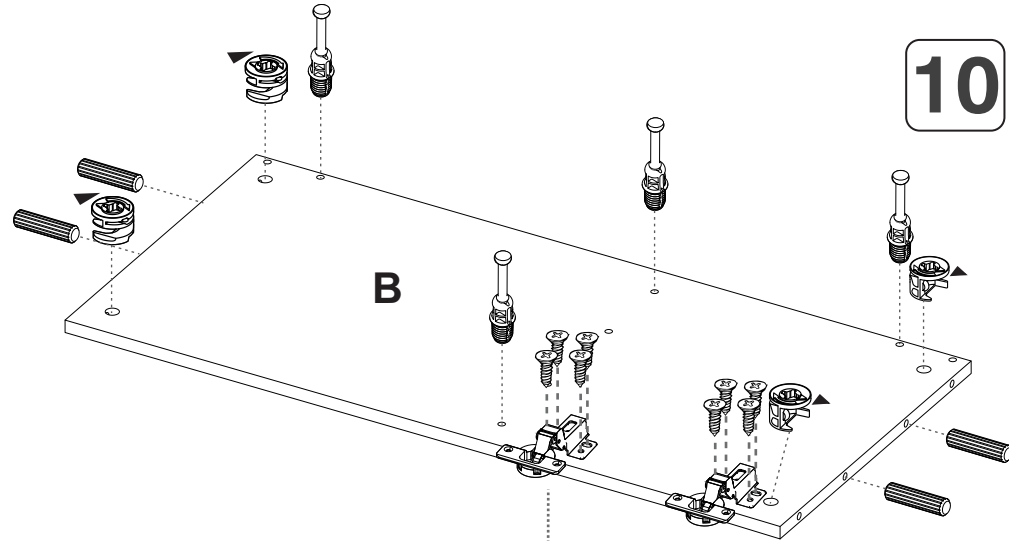

10

*Bisagra interna/
Inset Hinge*

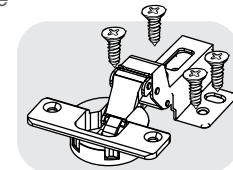

7

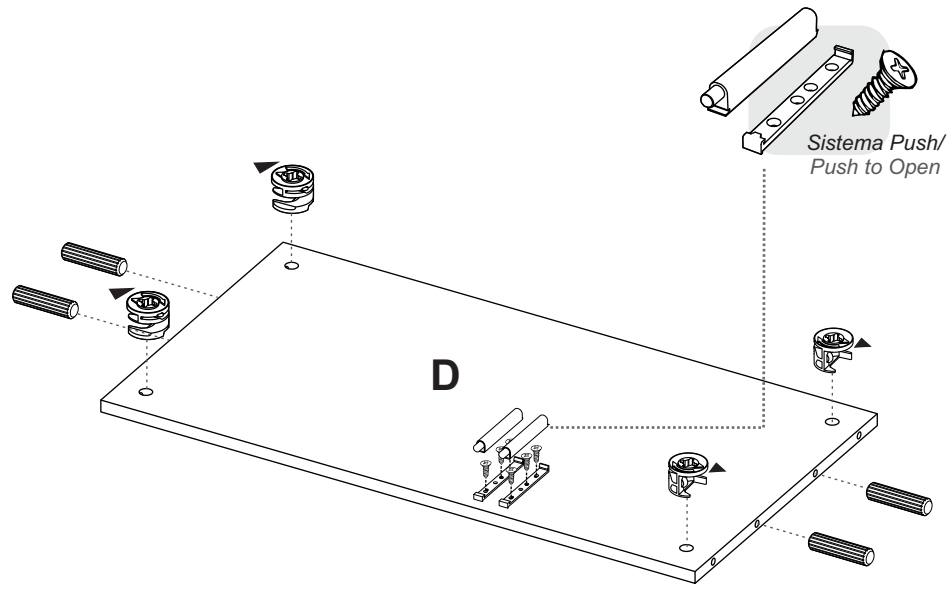
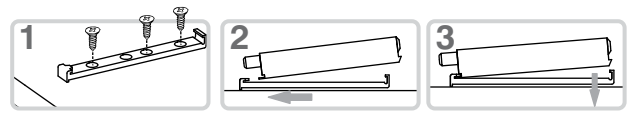

SE RECOMIENDA ARMAR EL MUEBLE ENTRE DOS PERSONAS / IT IS RECOMMENDED TO ASSEMBLE THE PRODUCT BETWEEN TWO PEOPLE

1

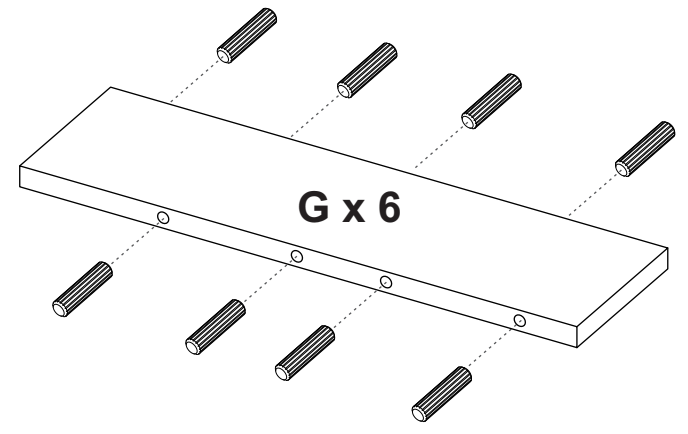

8

**VOLTEAR
TURN OVER**

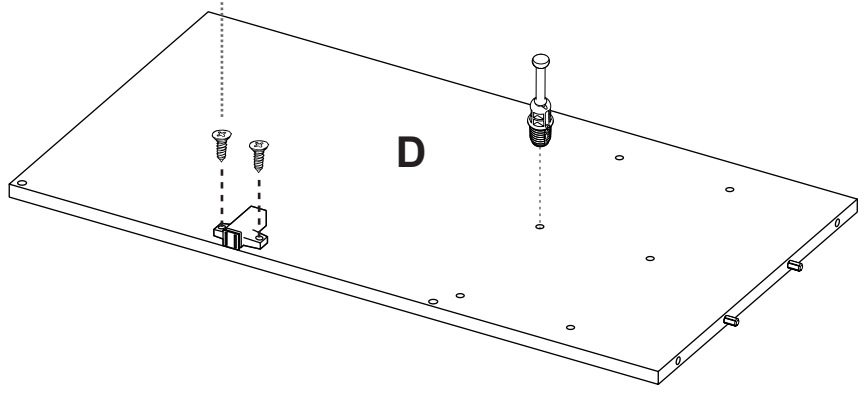
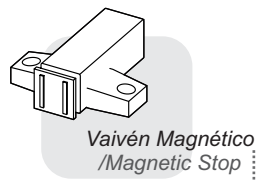

2

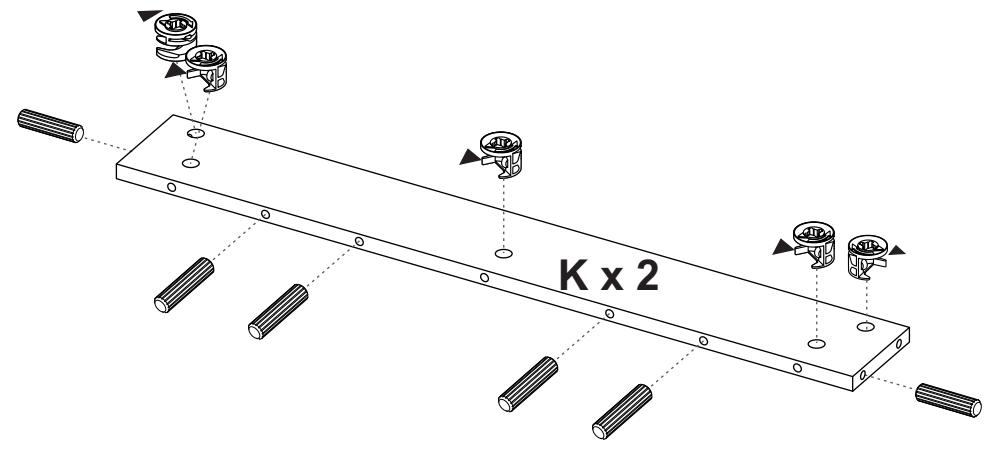

3

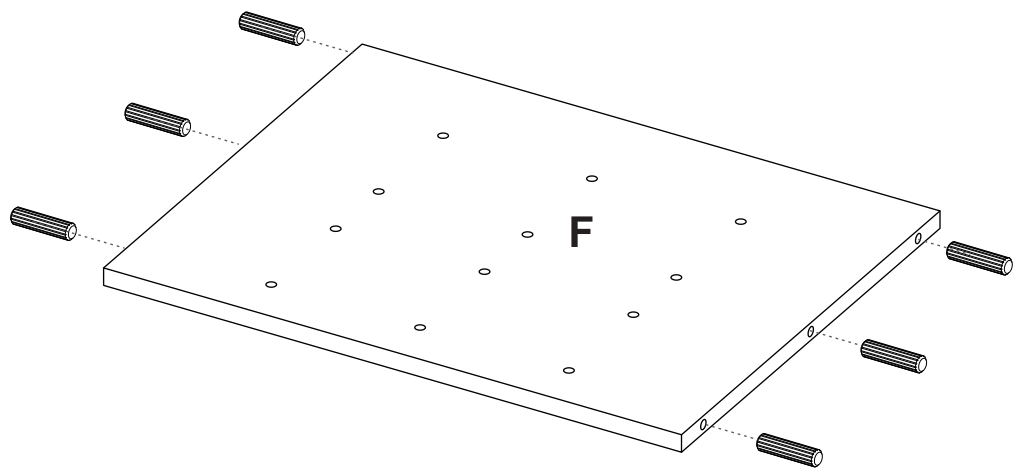

5

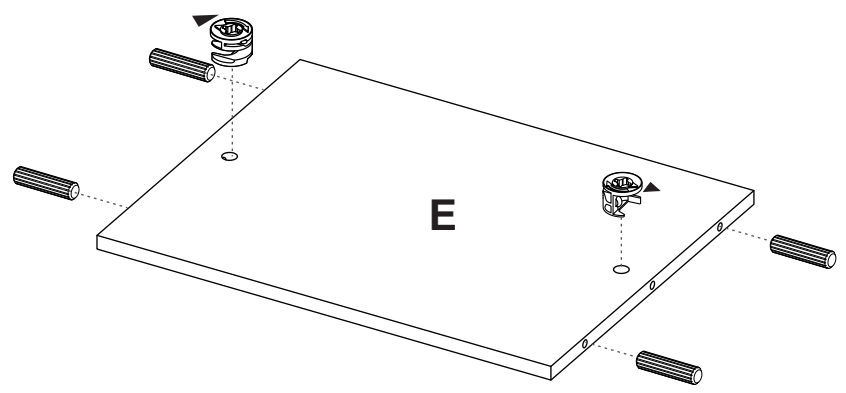

4

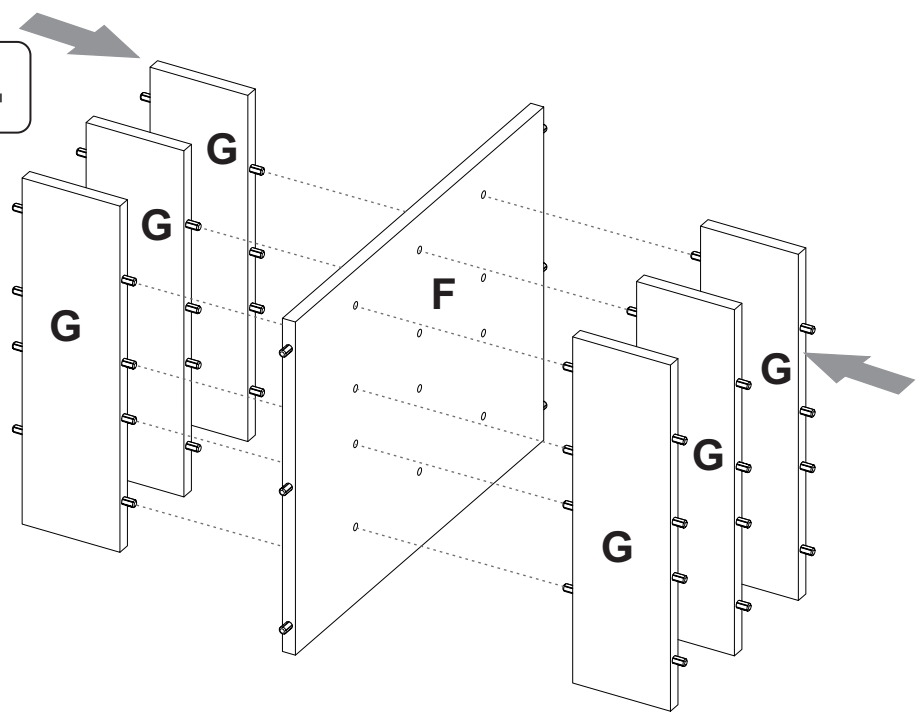

6

