

2

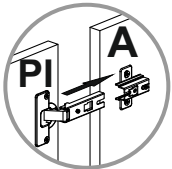

**INSTALACIÓN  
BISAGRA/  
Hinge Installation**

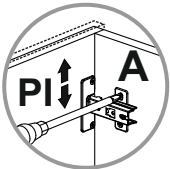

**AJUSTE DE  
ALTURA/  
Height Adjustment**

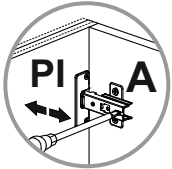

**AJUSTE DE  
PROFUNDIDAD/  
Depth Adjustment**

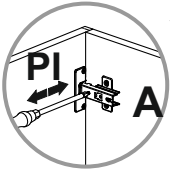

**AJUSTE DE  
LATERAL/  
Lateral Adjustment**

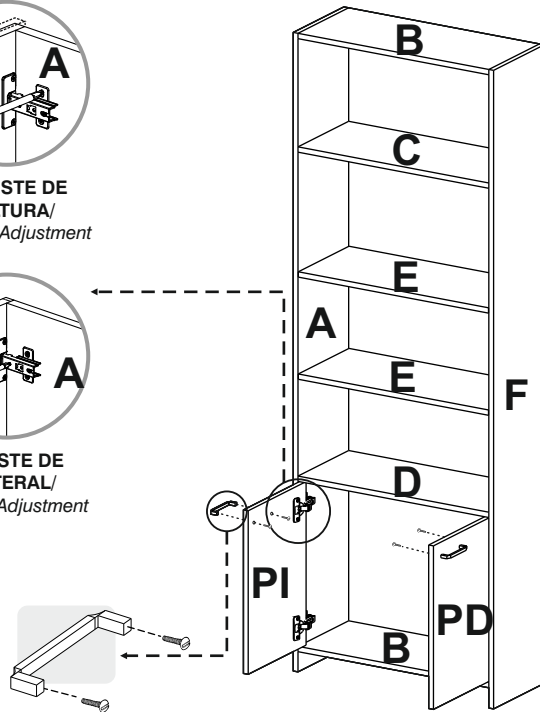

3

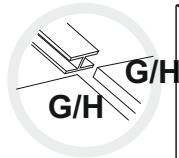

**Al finalizar el ajuste, cubra las cajas con las tapas adhesivas/ After tightening all the panels, cover the minifix cams with the adhesive caps.**

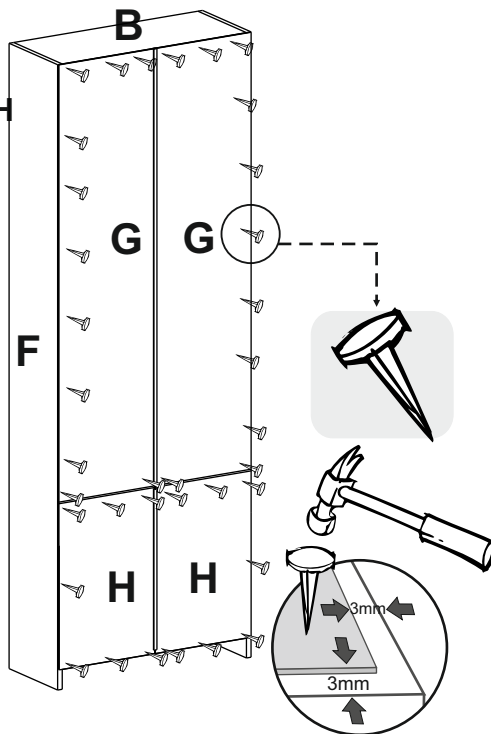

**Al terminar de armar despegue los adhesivos (en caso de que queden residuos de pegamento, limpie la superficie con alcohol) / When you finish off adhesive build (in case of residues of glue, wipe it with alcohol)**

**RTA**  
muebles

**INSTRUCCIONES DE ENSAMBLE  
ASSEMBLY INSTRUCTIONS**

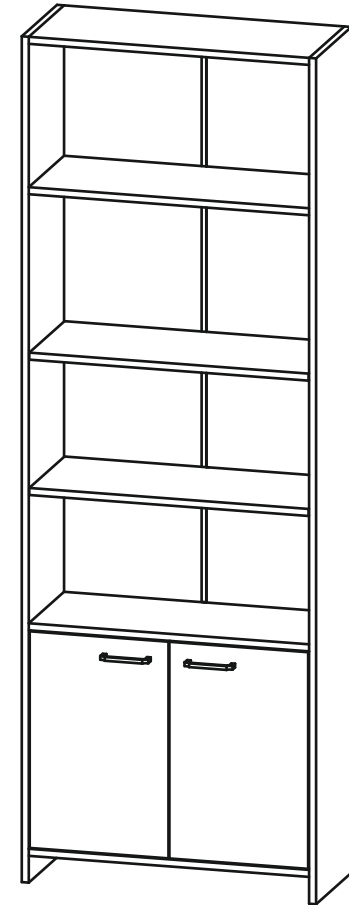

Alto/ Height: 180 cm / 70.9 in  
Ancho/ Width: 63 cm / 24.8 in  
Fondo/ Depth: 26 cm / 10.2 in

**LOT N°**

Tel - (572) 691 17 00  
PBX - (572) 695 91 81  
Yumbo - Valle del Cauca - Colombia  
www.rta.com.co

**BIBLIOTECA LISA 180 ECO CON PUERTA  
PLAIN BOOKCASE 180 ECO WITH DOORS**

## RECOMENDACIONES IMPORTANTES

No pintar el mueble.

El mueble debe ser usado únicamente en interiores, no exponer al sol directo.

Limpiar los herrajes metálicos con un paño seco.

NO sobrecargar el mueble (ver las cargas sugeridas).

No golpear ni martillar el mueble (solo cuando se indique).

Limpiar con un paño ligeramente húmedo, usar jabones suaves.

No arrastre el mueble, levántelo entre dos personas.

Evite el contacto directo con el agua, el fuego o la exposición a fuentes de calor.



### ADVERTENCIA

Nunca permita que los niños escalen o manipulen el mueble, la caída de este puede provocar lesiones graves o la muerte.

## IMPORTANT RECOMMENDATIONS

Do not paint the cabinet.

The cabinet **MUST** be used exclusively indoors, do not expose to direct sun.

Clean metallic hardware with a dry cloth.

Do **NOT** overload the cabinet (see suggested loads).

Do not hit or hammer the cabinet (just when indicated).

Clean with a slightly damp cloth, use gentle soaps.

Do not drag, lift and move between two people.

Avoid direct contact with water, fire or exposure to heat sources.



### WARNING

Never allow children to climb or manipulate the cabinet, furniture tip over can cause serious injuries or death.

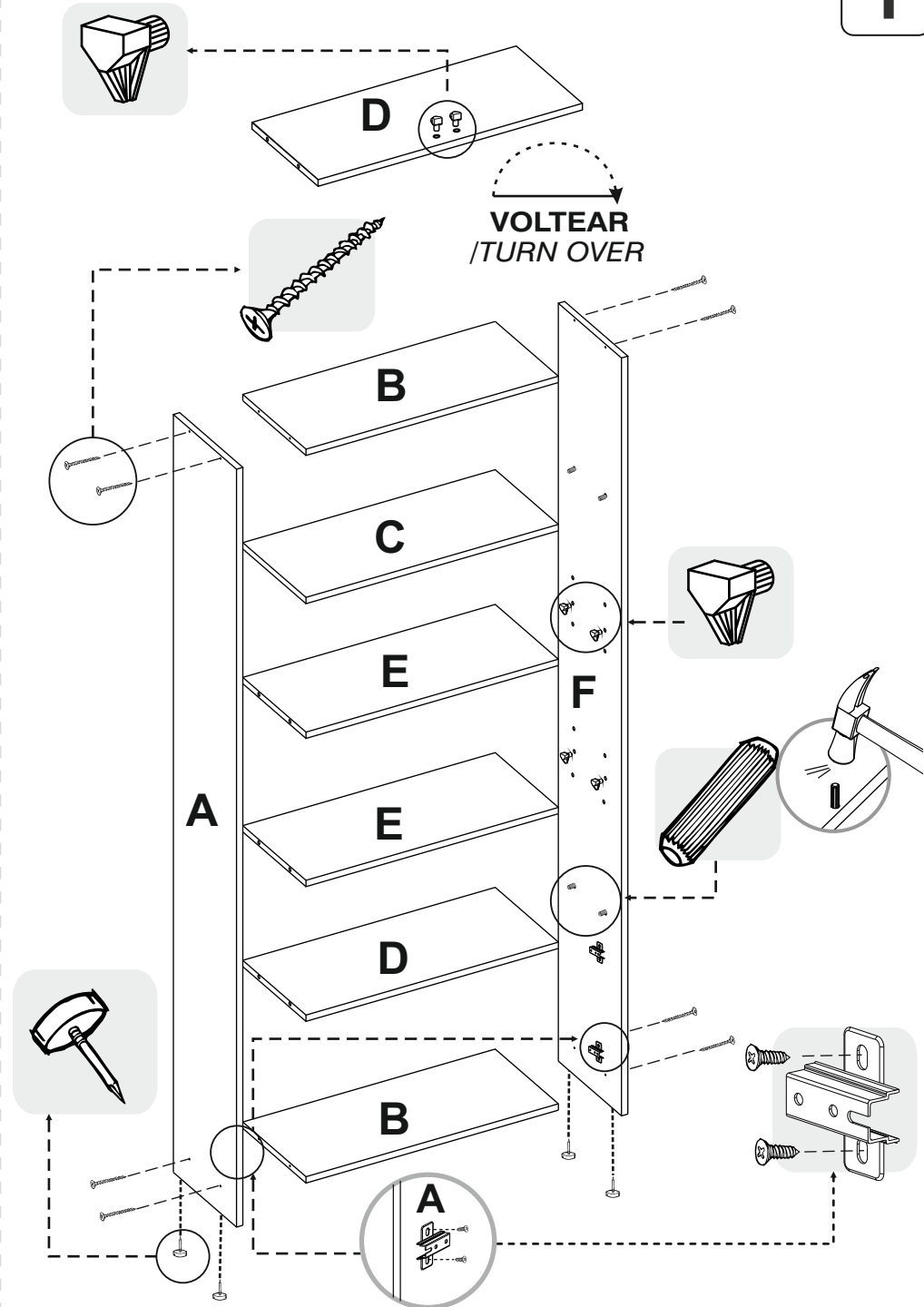

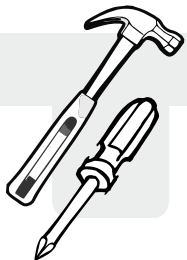

\*(Herramientas NO incluidas) \*Tools NOT Included

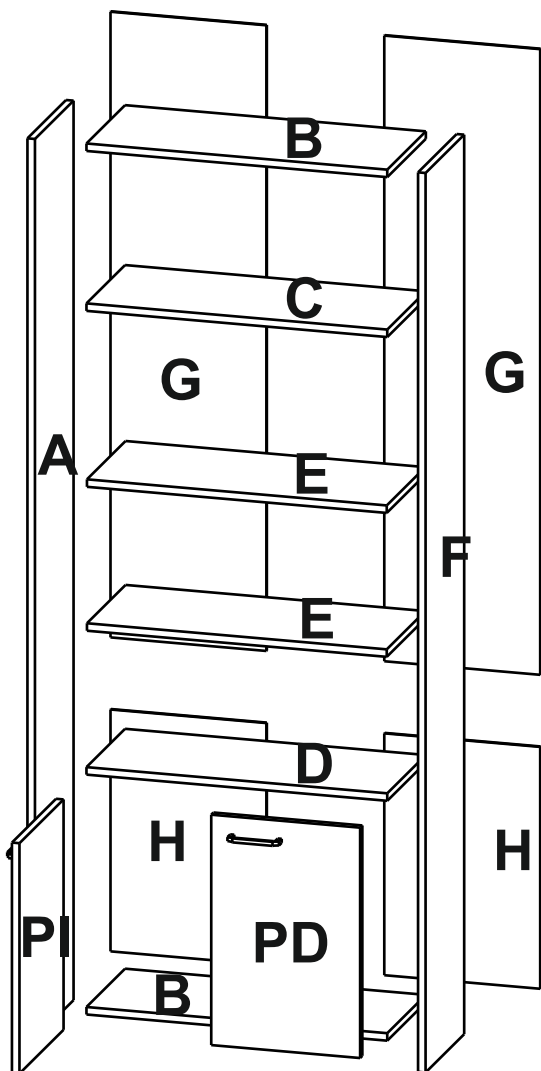

## RECOMENDACIONES DE ENSAMBLE / ASSEMBLY RECOMMENDATIONS

El buen funcionamiento del mueble depende de un adecuado ensamblaje  
An excellent furniture's performance relies on a solid and a suitable assembly.

### MINIFIX / CONNECTOR - DOWELS

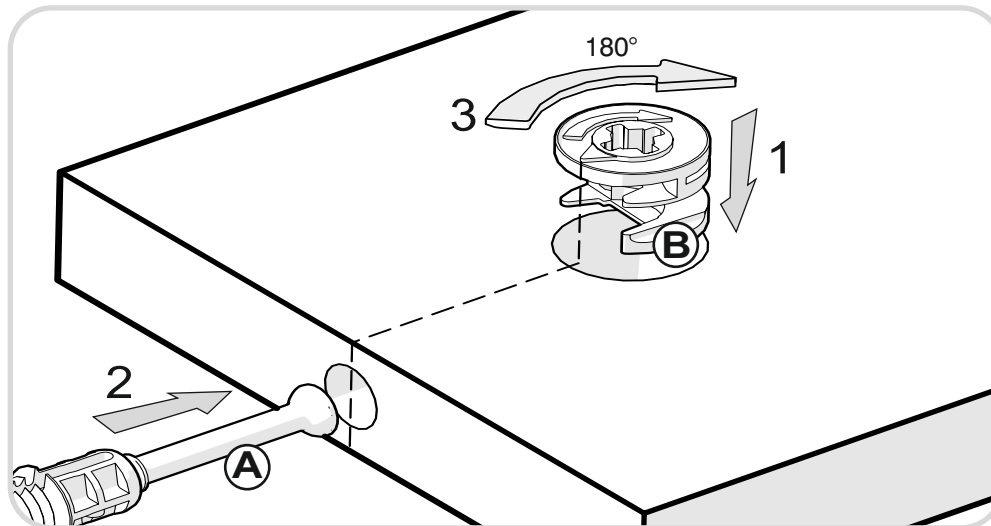

Sistema de unión compuesto por un perno (A) y una caja minifix (B).

(1) Se inserta la caja minifix dentro de la perforación ubicada en la cara de la pieza, la flecha debe apuntar siempre a la dirección de la perforación por donde entrará el perno.

(2) Se debe insertar el perno por su parte plástica en las perforaciones que se indiquen, luego se inserta la punta metálica en la perforación para que su cabeza quede al interior de la caja minifix.

(3) Girar la caja minifix 180° para apretar las dos piezas.

It's a fitting system made of a spreading bolt (A) and a minifix cam (B).

(1) Insert the minifix cam in the hole placed in the face of the panel with the arrow pointing towards the hole where the bolt will fit.

(2) Insert the bolt with its plastic base in the shown holes, then insert the metallic bolt head in the holes so it fits inside the minifix cam.

(3) Tight the panels by turning the minifix cam 180°.

### TARUGOS O TAQUETES / FLUTED DOWEL PIN

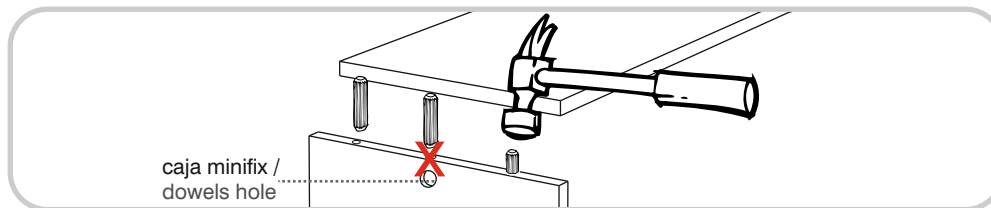

Es un pedazo de madera corto y grueso, de aproximadamente 5 a 10 cm de largo, que sirve para amarrar el mueble y darle resistencia.

It's a short and thick piece of wood, 1,9 to 3,9 inches approximately, which is used to tie the cabinet and give it resistance.

## HERRAJES PARA ARMADO ASSEMBLY HARDWARE

x8

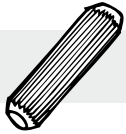

TARUGO/  
WOODEN PIN

x10



SOPORTE  
ENTREPAÑO/  
SHELF SUPPORT

x8



TORNILLO DE  
ENSAMBLE 2"/  
ASSEMBLY SCREW

x16



TORNILLO LAMINA  
PARA BISAGRA/  
SHEET METAL SCREW

x4



DESLIZADOR/  
NAIL ON GLIDE

x4

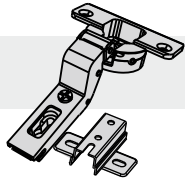

BISAGRA INTERIOR/  
INSET HINGE

x2



MANIJA 96mm/  
HANDLE

x4



TORNILLO  
MANIJA/  
HANDLE SCREW

x40



PUNTILLA/  
NAIL

x2

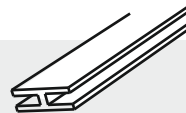

PERFIL EN H /  
GUIDE PROFILE BLACK



TENER PRECAUCIÓN AL ABRIR LA BOLSA DE HERRAJES PARA NO EXTRAVIAR NINGUNO. COMPRUEBE QUE EL CONTENIDO DE LAS PIEZAS SEA EL CORRECTO. EN CASO QUE FALTE ALGUNA PIEZA O ESTE DEFECTUOSA DEVUELVA LAS PIEZAS AL ALMACÉN CON SU FACTURA PARA EFECTUAR EL CAMBIO DE LAS PIEZAS Y/O LOS HERRAJES LO MÁS PRONTO POSIBLE. / PLEASE BE CAUTIOUS WHEN OPENING THE HARDWARE BAG TO NOT LOSE ANY. CHECK THE CONTENTS OF THE PARTS ARE CORRECT. IF ANY PART IS MISSING OR IMPERFECT PLEASE RETURN THE PARTS TO THE STORE WITH THE PRODUCT INVOICE ATTACHED TO MAKE EFFECTIVE THE REPLACEMENT OF THE IMPERFECT PIECES OR HARDWARE AS SOON AS POSSIBLE.

## PIEZAS DE ARMADO ASSEMBLY PARTS

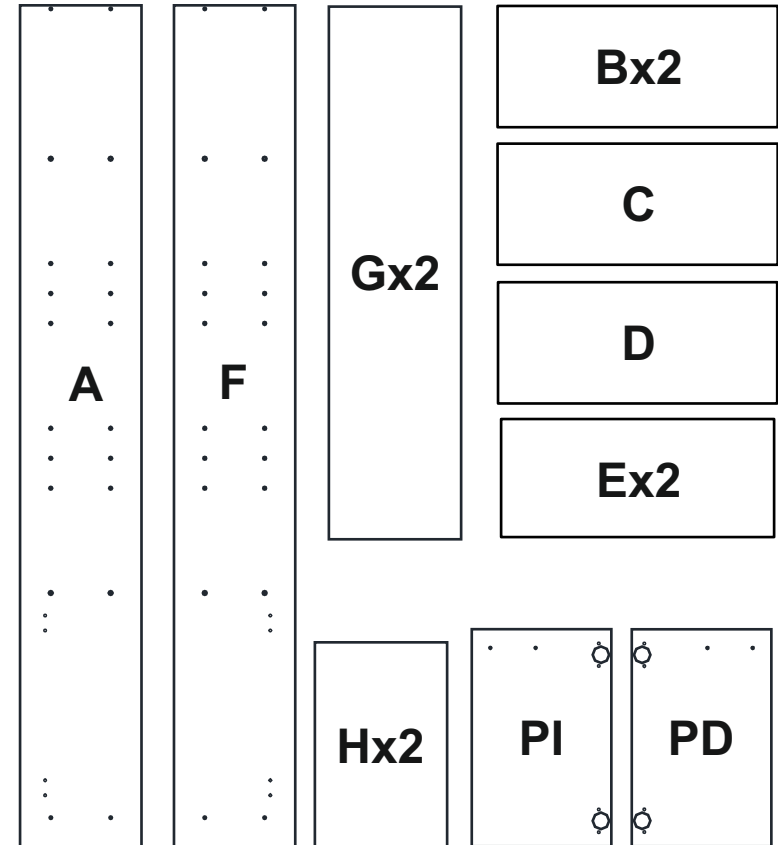

ANTES DE EMPEZAR A ARMAR EL MUEBLE LEA DETENIDAMENTE LAS INSTRUCCIONES. SE RECOMIENDA ARMAR EL MUEBLE SOBRE LA CAJA O SOBRE UNA SUPERFICIE LISA Y CUBIERTA, PARA NO RAYARLO / BEFORE STARTING TO ASSEMBLE THE FURNITURE, CAREFULLY READ THE INSTRUCTIONS. IT IS RECOMMENDED TO ASSEMBLE THE FURNITURE ON THE BOX OR ON A FLAT AND COVERED SURFACE IN ORDER TO NOT SCRATCH THE PRODUCT.