

5

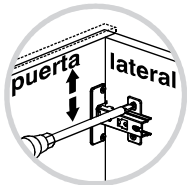

INSTALACIÓN BISAGRAS
aplica para todas las bisagras

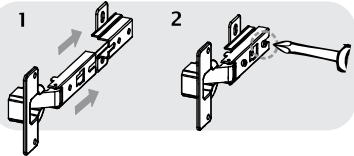

AJUSTE DE ALTURA

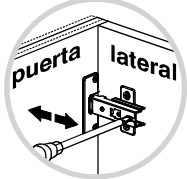

AJUSTE DE PROFUNDIDAD

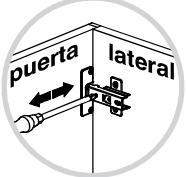

AJUSTE DE LATERAL

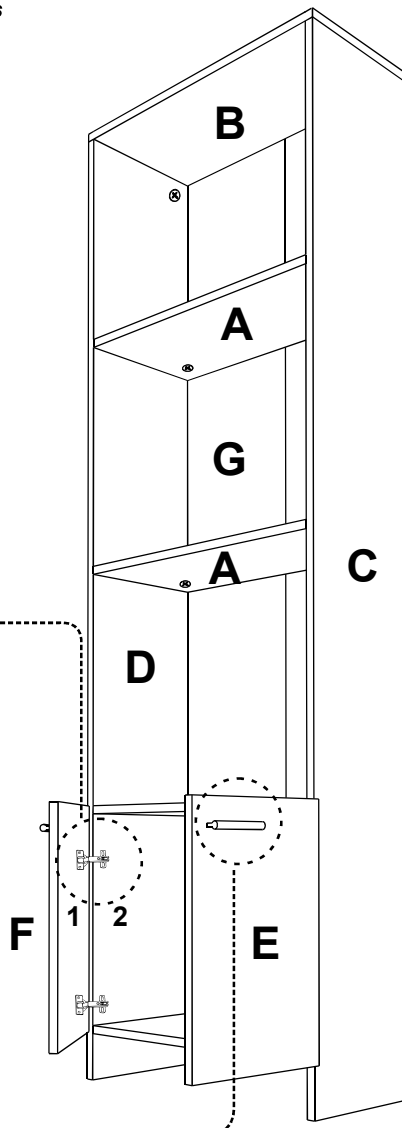
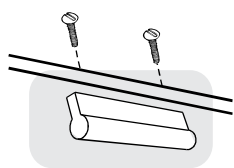

INSTRUCCIONES DE ENSAMBLE ASSEMBLY INSTRUCTIONS

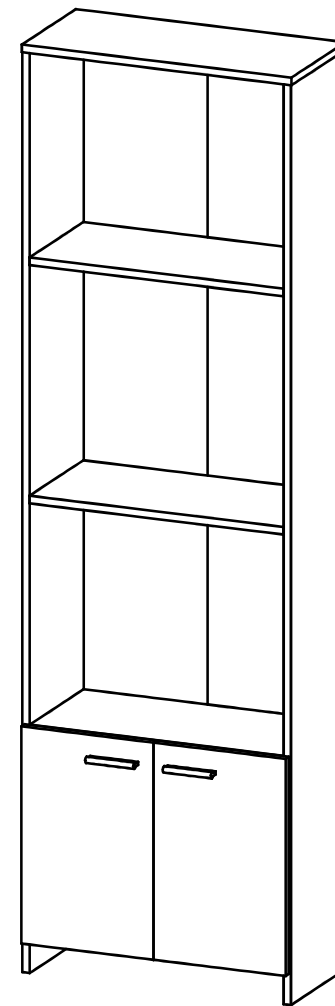

Alto/ Height: 181,5 cm / 71.45 in
Ancho/ Width: 55,1 cm / 21.69 in
Fondo/ Depth: 27 cm / 10.62 in

Al finalizar el ajuste de los conectores, proceda a poner las tapas adhesivas/
When you finish the adjustment of the connectors, proceed to put the cover tapes

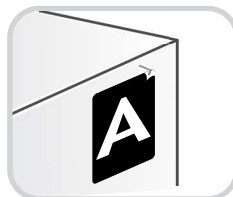

Al terminar de armar, desprenda los adhesivos (en caso de que queden residuos de pegamento, limpie la superficie con alcohol) / After finish assembling, tear off the adhesives. (In case of glue residues, wipe them with alcohol)

LOTE No: _____

finlandek BIBLIOTECA LISA EASY
/Easy Bookcase

RECOMENDACIONES IMPORTANTES KEY RECOMMENDATIONS

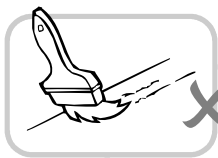

NO pinte el mueble /
Do not paint the
furniture.



NO mojar o ubicar
a la intemperie /
Do not expose to rain
or direct sun.

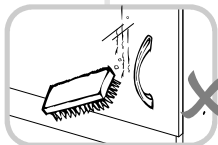
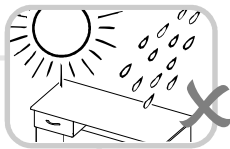

NO lavar las manijas o
tiraderas con jabones o
elementos abrasivos /
Do not wash handles or
drawers with soap or
abrasives.

NO sobrecargue el mueble.
no exceda el peso de 30 kilos
para gabinetes de cocina /
Do not overload the cabinet.
Weight max. 66lbs
for kitchen cabinets.

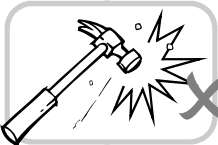

NO golpear ni martillar
el mueble (hágalo sólo
donde se indique) /
Do not hit or hammer
the furniture (just do it
where is indicated).

NO permita que los niños
manipulen el mueble, puede
voltearse y lastimarlos /
Do not allow children to
handle the cabinets or
drawers, they could get hurt.

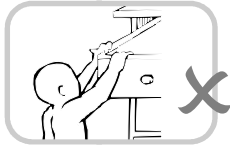

SIEMPRE levante el
mueble entre dos
personas, NO lo arrastre /
Do not drag the furniture.
Lift it between two people.

Limpie con paño seco,
/ Clean with a dry cloth.



HERRAJES BÁSICOS PARA MUEBLES RTA BASIC HARDWARE FOR RTA FURNITURE

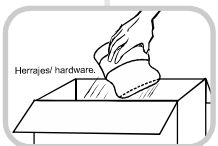

1. Abrir la caja del mueble
y buscar la bolsa con los
herrajes / Open the box
and look for the hardware
bag.

3. Separe los herrajes para
facilitar su identificación
durante el armado /
Separate hardware for easy
identification during
assembly.

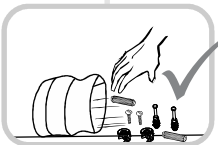
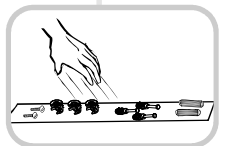

2. Abrir el paquete y
comprobar que el
contenido de las piezas es
correcto / Open the
package and verify that
the content of the pieces
is correct.

4. Arme el mueble en un lugar
limpio y en una superficie
plana / RTA furniture
must be assembled
in a clean place and on
a flat surface.

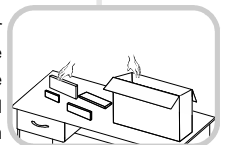

finlandek

3

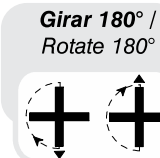
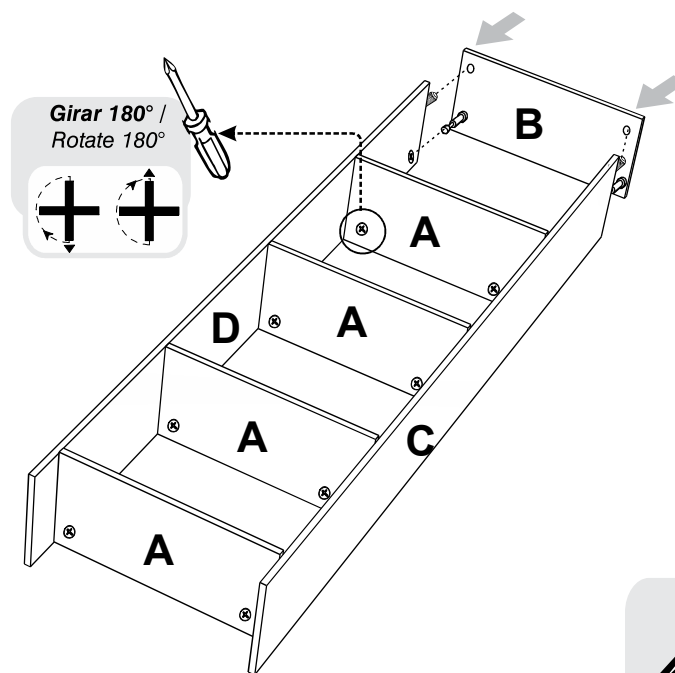

4

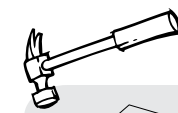
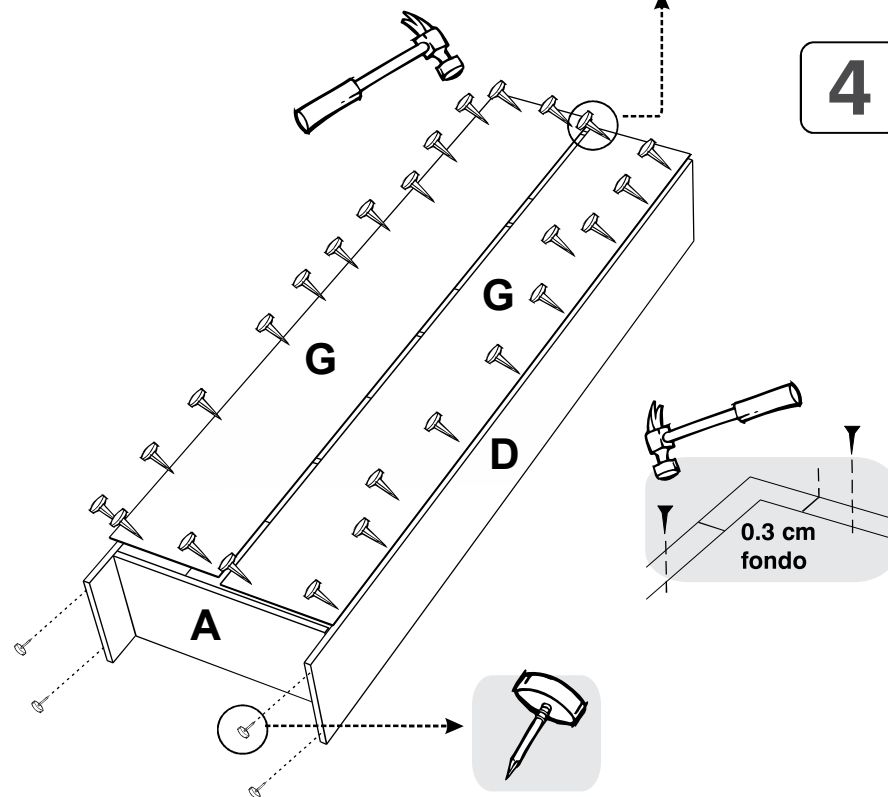

0.3 cm
fondo

1



SE RECOMIENDA ARMAR EL MUEBLE ENTRE DOS PERSONAS / IT IS RECOMMENDED TO ASSEMBLE THE PRODUCT BETWEEN TWO PEOPLE

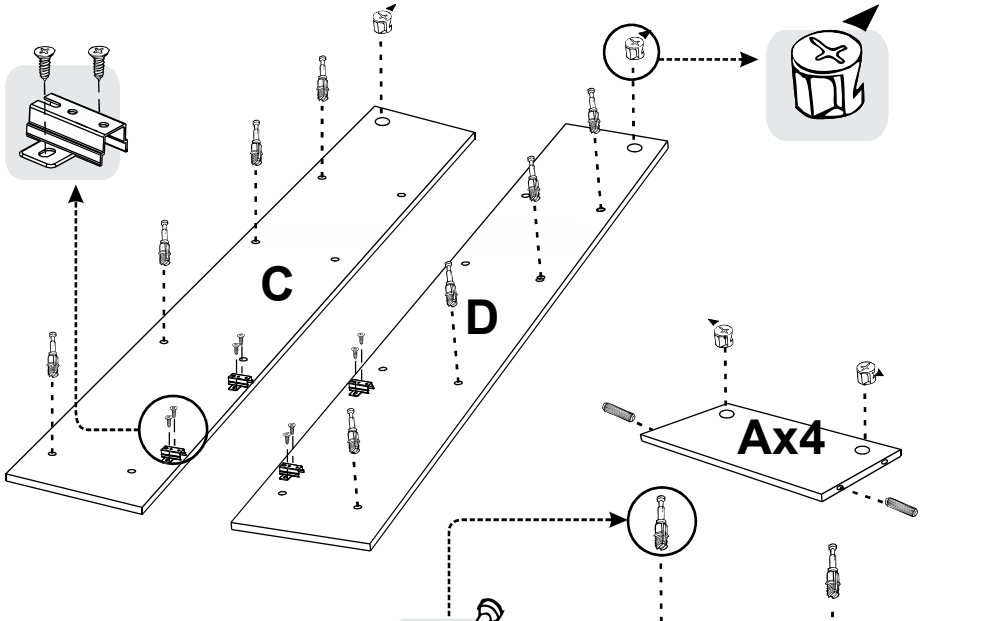

2

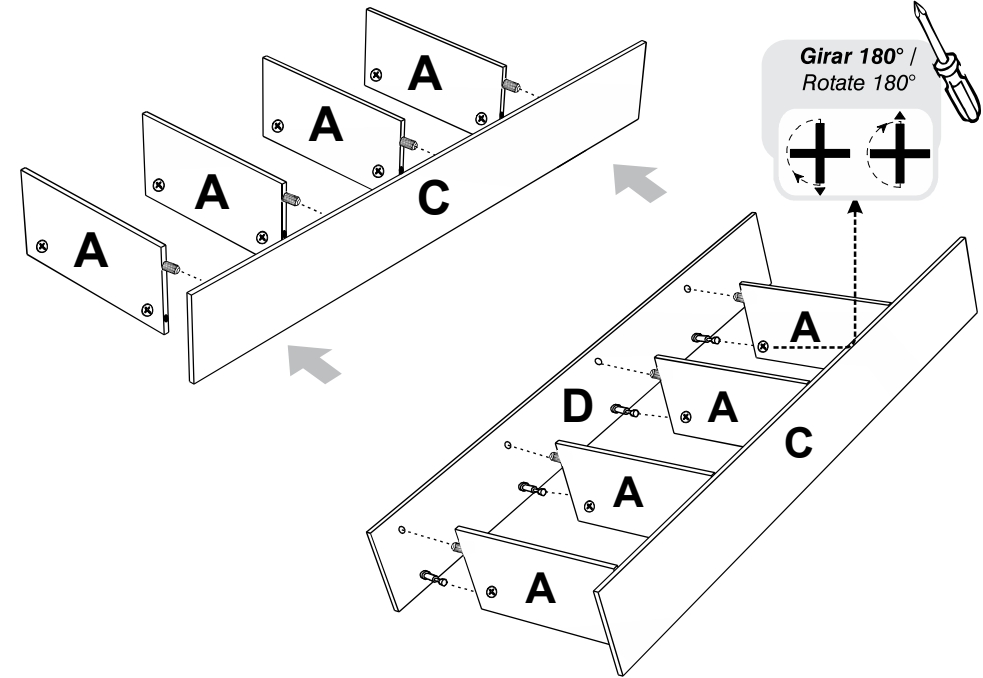

HERRAJES PARA ARMADO ASSEMBLY HARDWARE

x10 x10 x10 x10

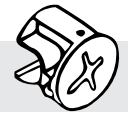

Minifix/
Minifix Cams

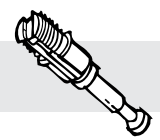

Perno minifix/
Spreading Bolt



Tarugo/
Wooden Pin

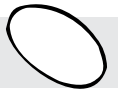

Tapa Adhesiva
Minifix/
Cover Caps

x4



Deslizador Puntilla/
Nail Glide

x30



Puntillas/
Nails

x4

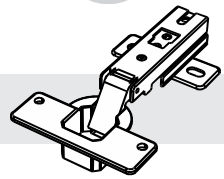

Bisagra Parche
35mm/
Full Overlay Hinge

x2

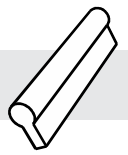

Manija Aluminio/
Handle



TENER PRECAUCIÓN AL ABRIR LA BOLSA DE HERRAJES PARA NO EXTRAVIAR NINGUNO. COMPRUEBE QUE EL CONTENIDO DE LAS PIEZAS SEA EL CORRECTO. EN CASO QUE FALTE ALGUNA PIEZA O ESTE DEFECTUOSA DEVUELVA LAS PIEZAS AL ALMACÉN CON SU FACTURA PARA EFECTUAR EL CAMBIO DE LAS PIEZAS Y/O LOS HERRAJES LO MÁS PRONTO POSIBLE. / PLEASE BE CAUTIOUS WHEN OPENING THE HARDWARE BAG TO NOT LOSE ANY. CHECK THE CONTENTS OF THE PARTS ARE CORRECT. IF ANY PART IS MISSING OR IMPERFECT PLEASE RETURN THE PARTS TO THE STORE WITH THE PRODUCT INVOICE ATTACHED TO MAKE EFECTIVE THE REPLACEMENT OF THE IMPERFECT PIECES OR HARDWARE AS SOON AS POSSIBLE.

PIEZAS DE ARMADO
ASSEMBLE PARTS

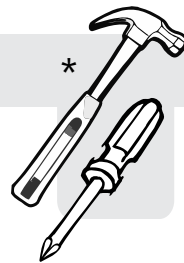
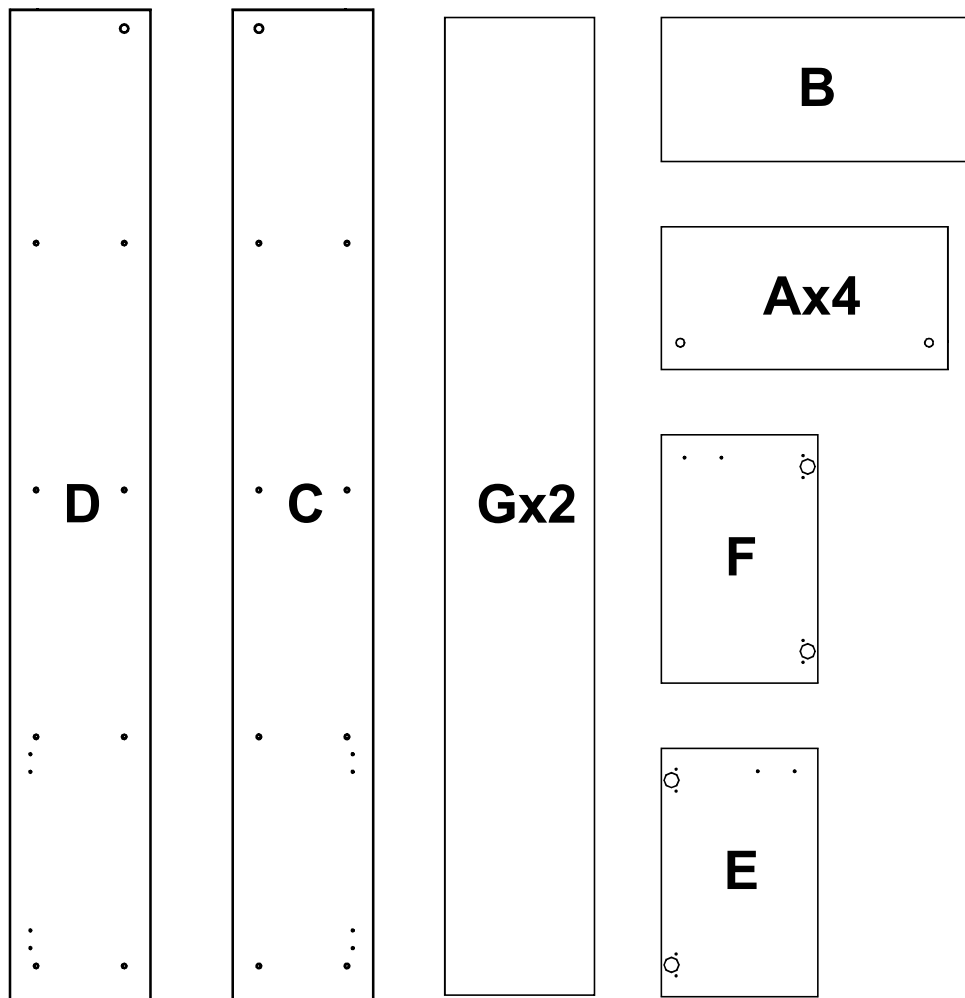

**(Herramientas NO incluidas)*

**Tools NOT Included*

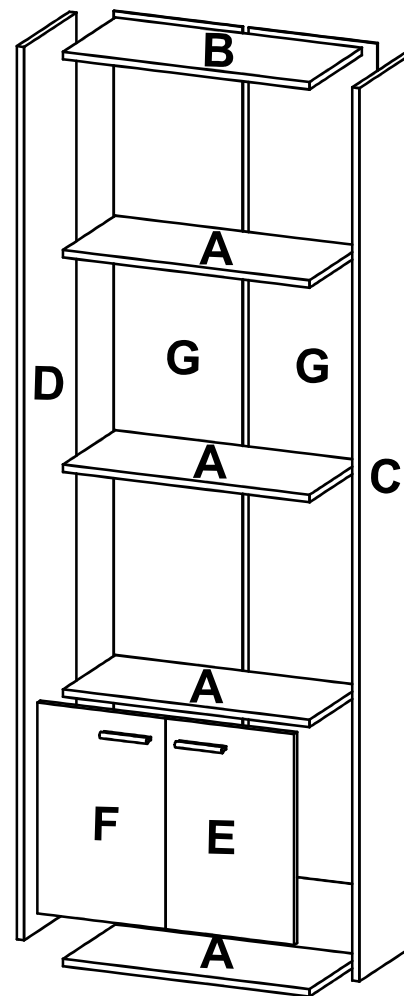

ANTES DE EMPEZAR A ARMAR EL MUEBLE LEA DETENIDAMENTE LAS INSTRUCCIONES. SE RECOMIENDA ARMAR EL MUEBLE SOBRE LA CAJA O SOBRE UNA SUPERFICIE LISA Y CUBIERTA, PARA NO RAYARLO / BEFORE STARTING TO ASSEMBLE THE CABINET, CAREFULLY READ THE INSTRUCTIONS. IT IS RECOMMENDED TO ASSEMBLE THE FURNITURE ON THE BOX OR ON A FLAT AND COVERED SURFACE IN ORDER TO NOT SCRATCH THE PRODUCT.