

WATERSNAKE[®]

SIDEWINDER CV

TRANSOM MOUNT ELECTRIC MOTOR

OWNERS MANUAL



**Jarvis
Marine[®]**

www.jarviswalker.com.au

WATERSNAKE ELECTRIC MOTORS

Congratulations and welcome to a world of silent motoring.

Powerful yet silent, the Watersnake electric motors are built to suit all angling conditions. High quality materials, superior design and precision engineering make these motors longwearing and reliable.

ATTACHING THE MOTOR TO YOUR BOAT

Attach the motor to the stern of the boat and tighten both mounting bolts securely while taking care not to over-tighten. (A)

To adjust the angle of the motor after attachment, hold the motor head with one hand and depress the positioning pin at the top of the mounting bracket with your other hand. Press and hold the positioning pin until the desired angle has been reached, next release the pin and ensure the mechanism locks securely. (B)

(A)

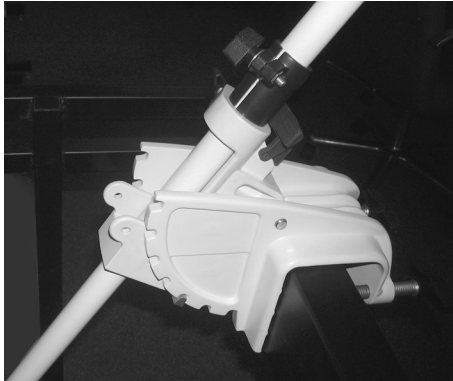

(B)



SIDEWINDER

WATERSNAKE

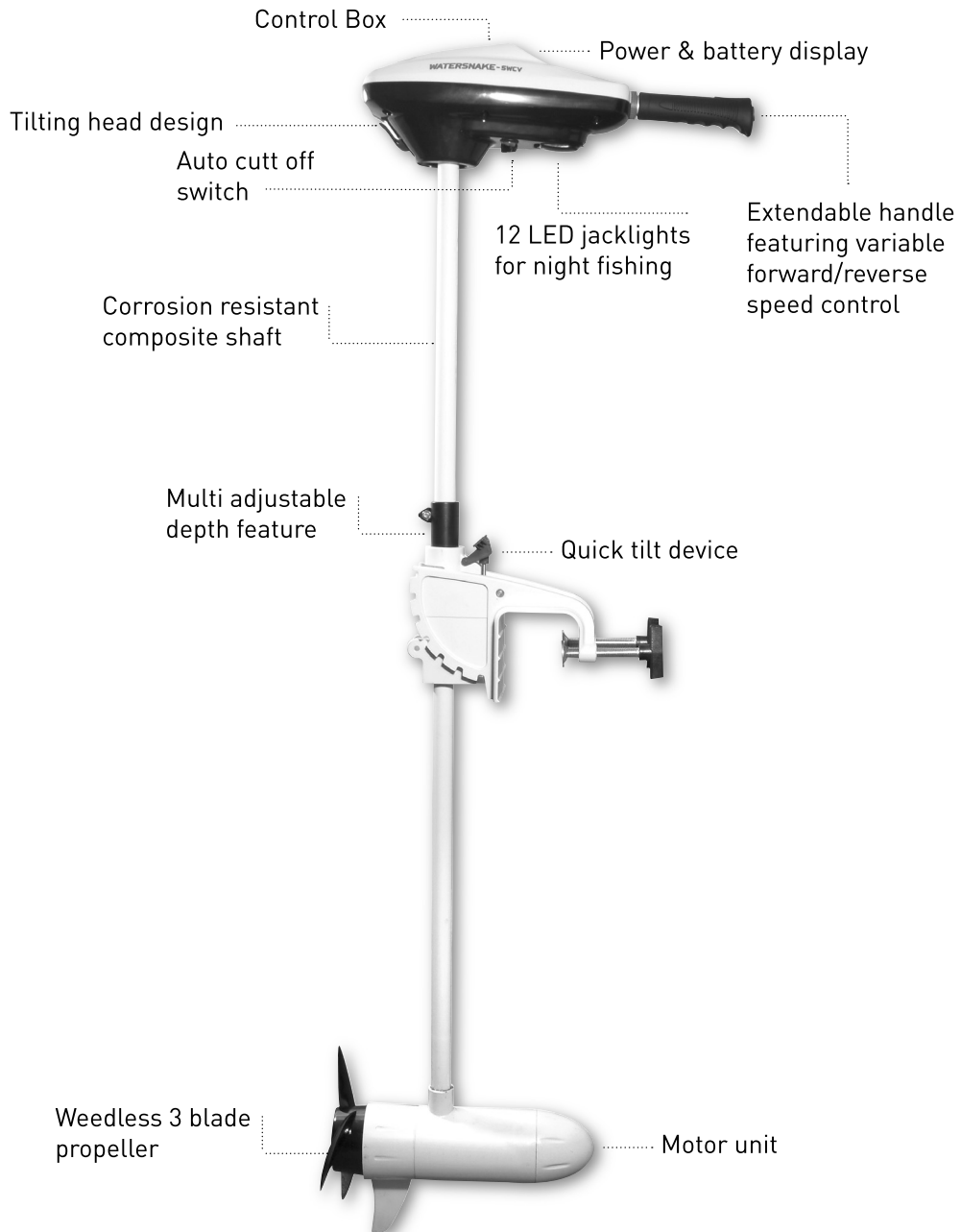

DEPTH ADJUSTMENT

Hold the motor shaft with one hand, loosen the depth adjustment screw and set the motor to the desired depth, then retighten the adjusting screw securely. (C1)

STEERING

To adjust steering counter-force, simply loosen or tighten the counterforce bolt. The ideal setting is one where the counterforce bolt is just tight enough so that the boat will steer in the direction you are aiming without need for continual correction. (C2)

HEAD UNIT & SPEED CONTROL

Power on/off switch is positioned underneath the head unit, activate to use the motor and when de-activated this function will prevent any amp draw from your battery.

The tiller control is telescopic and can be extended to 16cm. Simply push the button at the end of the grip (D) to set your desired length. The speed control is variable, rotate the handle clockwise for forward speed and anti-clockwise for reverse. (E)

The tilting head design allows you to fix the head in your desired position. Loosen the key lock and move the head in position, then tighten.

POWER & BATTERY GAUGE

Power meter shows speed settings in percentages, full motor speed is 100%. The battery indicator will only be indicated when the motor speed is at zero.

The Watersnake CV motors are fitted with a 12 LED Jacklight system when fishing at night.

Located underneath the head unit, to turn on open the cover. The lights will turn off automatically when the cover is closed.

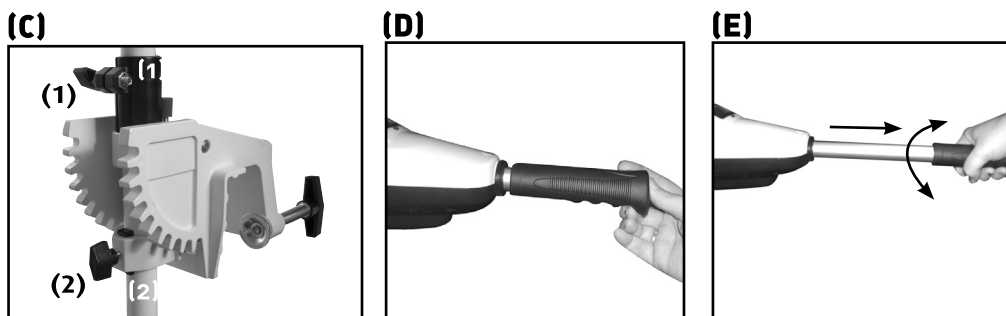

WATERSNAKE

CHANGING THE PROPELLER

Before doing anything with the propeller, ensure the cables to the battery are disconnected.

To detach the propeller is a simple matter of unscrewing and removing the locknut using the special tool supplied. When doing this, take hold of the propeller to stop it turning. Under no circumstances should you attempt to loosen the locknut with a hammer or similar tool as this may damage the locknut and or shaft – or both. (F)

Once the locknut is removed, the propeller can be slid from the shaft. When putting the propeller back on, verify there is a proper fit of the groove and shear pin otherwise the propeller will not be locked. (G)

After using the motor always check and clear any weed or fishing line that may have become tangled around the propeller. Next, give the motor a wipe down with warm water to remove any salt or sand particles and then spray it with fresh water.

(F)



(G)

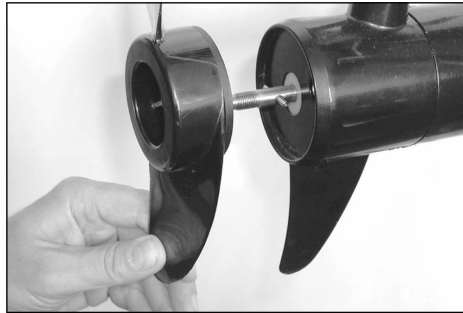

Watersnake Propeller Kits (Sold Separately)

Watersnake Propeller kits contain a propeller, propeller nut and shear pins. It is recommended you keep a spare propeller on your boat at all times. The Mini 2-Bladed Kit is suitable for the T-18 motors. The 2-Bladed Propeller Kit is suitable for 28lb, 30lb and 34lb motors. The 3-Bladed Medium Propeller Kit is suitable for all 44lb and 54lb motors. The 3-Bladed Large Propeller Kit is suitable for all 70lb, 80lb and 105lb motors.



55008
Large 3 Blade
Prop (70lb-105lb)



55130
3 Blade Prop
(44lb-54lb)



55131
2 Blade Prop
(28-34lb)



JM56001
2 Blade Mini Prop
(18lb)

ELECTRICAL CONNECTIONS

Before connecting the motor's cables to the battery terminals, ensure all switches are in the OFF position and stand clear of the propeller.

Connect the red cable to the positive (+) terminal and the black cable to the negative (-) terminal, making sure the terminals are clean before doing so. A clean connection will minimise power wastage and give you maximum power from the battery.

The battery should be kept in a well-ventilated location. We recommend using a special deep cycle marine battery for optimum performance.

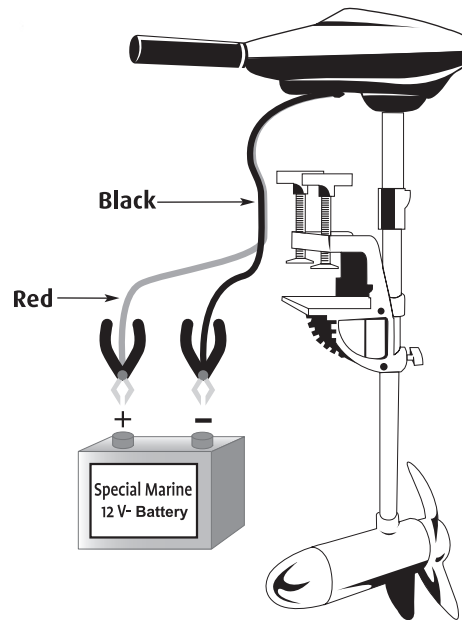

WATERSNAKE

ELECTRICAL CONNECTIONS CONTINUED

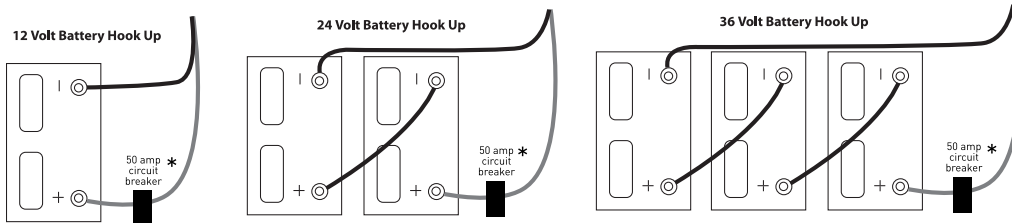

*Available separately

Freshwater Models (FWCV)

MODEL	MAX THRUST	CONTROL	SPEEDS	VOLTAGE/AMPS	SHAFT MATERIAL	SHAFT LENGTH
FWCV44	44lbs	By Hand	Variable	12V/40A	Composite	36"/90cm
FWCV50	50lbs	By Hand	Variable	12V/46A	Composite	42"/105cm
FWCV54	54lbs	By Hand	Variable	12V/48A	Composite	48"/120cm
FWCV70	70lbs	By Hand	Variable	24V/42A	Composite	48"/120cm

Saltwater Models (SWCV)

MODEL	MAX THRUST	CONTROL	SPEEDS	VOLTAGE/AMPS	SHAFT MATERIAL	SHAFT LENGTH
SWCV44-36	44lbs	By Hand	Variable	12V/40A	Composite	36"/90cm
SWCV44-48	44lbs	By Hand	Variable	12V/40A	Composite	48"/120cm
SWCV50-48	50lbs	By Hand	Variable	12V/46A	Composite	48"/120cm
SWCV54-42	54lbs	By Hand	Variable	12V/48A	Composite	42"/105cm
SWCV80-48	80lbs	By Hand	Variable	24V/48A	Composite	48"/120cm
SWCV80-54	80lbs	By Hand	Variable	24V/48A	Composite	54"/135cm
SWCV105-54	105lbs	By Hand	Variable	36V/53A	Composite	54"/135cm



TROUBLESHOOTING

PROBLEM

POSSIBLE CAUSE/SOLUTION

Speed loss

- 1: Check for line or weed on propeller.
- 2: Check battery status.
- 3: Check terminals on battery.

Motor noise/ shake

- 1: Check propeller for line or weed.
- 2: Check to see propeller is secure and not damaged.
- 3: Check shaft to ensure it is not bent. Detach propeller and run motor visually to ensure shaft is not shaking. If shaft is damaged contact your retailer or service centre.

Loss of speed setting

- 1: Check all wiring connections.
- 2: Speed coil in motor may be burned, contact your retailer or service centre.

Tight steering

- 1: Loosen counterforce screw, apply lubricant and re-adjust.

For problems not listed contact your retailer or service centre.

MAINTENANCE

At the end of the day, wipe the motor down with a cloth soaked in warm water and then rinse unit with light spray from hose. Always check the propeller is clear of line or weed, regularly check all nuts, bolts and screws and lubricate all moving parts with an aerosol lubricant. Clean terminal connections regularly and check for frayed wires or loose connections.

STORAGE

When storing the motor, lubricate all moving parts and screws and store in a well-ventilated, dry area. Do not leave the motor outside in winter for long periods, as this will damage the permanent magnet in the unit.

WATERSNAKE

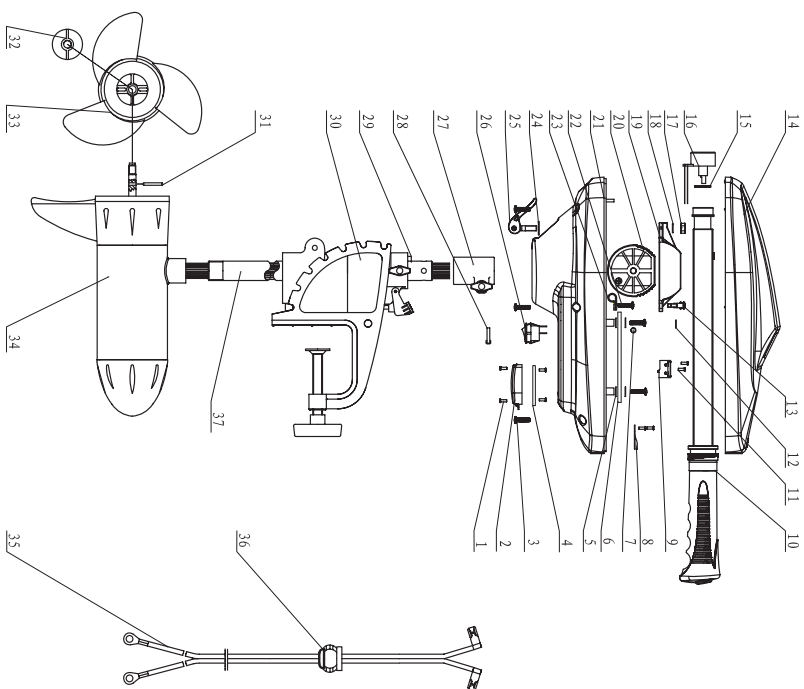

No.	Part Name	Description	Qty
1	HP6, 657, 037, 99	Start ((SWC980/54)	1
2	HP6, 657, 036, 99	Start ((SWC44/48, SWC50/48)	1
3	HP6, 661, 016, 00	Cable Clip	1
4	HP6, 647, 001, 00	Main Battery Cable	1
5	HP6, 002, 056, 00	SW/HC80-59C Motor Assy (SWC980/54)	1
6	HP6, 002, 055, 00	SW/HC50-48C Motor Assy (SWC50/48)	1
7	HP6, 002, 054, 00	SW/HC44-48C Motor Assy (SWC44/48)	1
8	HP6, 393, 001, 00	Prop (SWC980/54)	1
9	HP6, 393, 001, 00	Prop (SWC44/48, SWC50/48)	1
10	HP6, 482, 001, 00	Prop Nut	1
11	HP6, 264, 334, 00	Pin (SWC980/54)	1
12	HP6, 264, 157, 45	Pin (SWC44/48, SWC50/48)	1
13	HP6, 152, 005, 00	Mount Assy (SWC980/54)	1
14	HP6, 152, 001, 01	Mount Assy (SWC44/48, SWC50/48)	1
15	HP6, 602, 012, 10	Tension Block (SWC980/54)	1
16	HP6, 602, 007, 10	Tension Block (SWC44/48, SWC50/48)	1
17	HP6, 636, 008, 00	Fixing Wire Bolt	2
18	HP6, 257, 005, 00	Depth Adjust Collar Assy (SWC980/54)	1
19	HP6, 257, 004, 00	Depth Adjust Collar Assy (SWC44/48, SWC50/48)	1
20	HP7, 330, 003, 00	Power Switch	1
21	HP6, 272, 004, 00	Lock Handle Assy	1
22	HP6, 467, 028, 00	Washer	1
23	HP6, 940, 091, 45	Wire Clip	1
24	HP6, 903, 059, 00	Bolt	4
25	HP6, 171, 037, 00	Bottom Cover Assy	1
26	HP6, 502, 013, 00	Battery Block (SWC980/54)	1
27	HP6, 502, 011, 00	Battery Block (SWC44/48, SWC50/48)	1
28	HP6, 076, 047, 00	Impaction Cover	1
29	HP6, 340, 269, 00	Washer	1
30	HP6, 379, 053, 45	Kit M6	1
31	HP6, 630, 000, 00	Potentiometer Assy	1
32	HP6, 946, 011, 07	Lock Washer	1
33	HP6, 171, 046, 00	Top Cover Assy (SWC980/54)	1
34	HP6, 171, 036, 00	Top Cover Assy (SWC44/48, SWC50/48)	1
35	HP6, 904, 052, 00	Bolt	2
36	HP6, 940, 005, 00	Washer	2
37	HP6, 903, 045, 00	Bolt	2
38	HP6, 465, 048, 00	Handle Assy	1
39	HP6, 618, 006, 00	Switch Assy	1
40	HP6, 387, 066, 45	Spring Piece	1
41	HP6, 264, 349, 45	Pin	1
42	HP6, 672, 017, 00	Relay Control Board (SWC980/54)	1
43	HP6, 672, 008, 00	Relay Control Board (SWC44/48, SWC50/48)	1
44	HP6, 672, 016, 00	Diode Control Board (SWC980/54)	1
45	HP6, 672, 007, 00	Diode Control Board (SWC44/48, SWC50/48)	1
46	HP6, 903, 056, 45	Bolt	6
47	HP6, 073, 013, 00	Light Box	1
48	HP6, 903, 042, 45	Bolt	6

SWC Series



JARVIS MARINE INTERNATIONAL – 12 MONTH WARRANTY PROVISIONS

1. Product safety

Provision of the goods by Jarvis Marine in no way reduces the purchaser's obligation to ensure that their use of the goods and the relevant operating environment is safe and in accordance with Jarvis Marine's directions relating to care, maintenance and storage of the goods.

2. Product warranty

- (a) All goods manufactured by Jarvis Marine that have been subjected to normal and proper use are warranted to be free from material defects in material and workmanship for a period of one year from the date of purchase.
- (b) Jarvis Marine will use its reasonable endeavours to rectify at its cost any defect in the goods notified to it during the warranty period.
- (c) The purchaser's sole remedy for a breach of clause 2(a) is the repair, replacement or resupply of the goods. Jarvis Marine will not be liable to rectify any defect in the goods if:
- (1) the goods have been altered or modified without Jarvis Marine's authorisation;
 - (2) the defect is the result of or related to a failure of the purchaser to comply with any of its obligations under these terms;
 - (3) or the defect is the result of or related to the use of the goods other than in accordance with this documentation or Jarvis Marine's reasonable recommendations or directions.

3. Limitations on Liability

Limited and excluded liability

Unless this warranty provides otherwise, the maximum aggregate liability of Jarvis Marine for all proven losses, damages and claims arising out of this warranty, including liability for breach, in negligence or in tort or for any other common law or statutory action, is limited to the sum of the amount paid by the purchaser to Jarvis Marine. Notwithstanding any other provisions, Jarvis Marine will not be liable to the purchaser or to any other person for: any losses or damages of any kind caused by or resulting from any wrongful, wilful or negligent act or omission of Jarvis Marine or any of its officers, employees, agents or contractors; or any indirect, incidental, special or consequential damages, including loss of profits or anticipated profits, even if notified of the possibility of that potential loss or damage.

Exclusion of implied warranties.

Any representation, warranty, condition or undertaking that would be implied in this warranty by legislation, common law, equity, trade, custom or usage is excluded to the maximum extent permitted by law.

Non-excludable rights implied by statute.

Nothing in this warranty excludes, restricts or modifies any condition, warranty, right or remedy conferred on the purchaser by the Trade Practices Act 1974 (Cth) or any other applicable law and which cannot be excluded, restricted or modified by agreement. Liability for breach of non-excludable rights to the fullest extent permitted by law, the liability of Jarvis Marine for a breach of a non-excludable condition or warranty referred to and as otherwise provided for in these terms are limited, at Jarvis Marine's option, to the replacement of the goods or the supply of equivalent goods; the repair of the goods; the payment of the cost of replacing the goods or of acquiring equivalent goods; or the payment of the cost of having the goods repaired.

4. Warranty service

A copy of the proof of purchase or registration verification is required to obtain warranty service. Please contact Anglers Central Service centre for servicing and Spare parts. Goods sent to repair centre at owners cost.

Anglers' Central Service Centre Pty Ltd; Australia's largest tackle repair centre and the authorised service and repair centre for all Penn, Rovex, Jarvis Walker and Jarvis Marine products throughout Australia.
email: spareparts@anglerscentral.com.au
Ph: 08 8244 8790 Free Fax: 1300 763 331
Delivery address: 2/7 Circuit Drive, Hendon SA 5014

When applying for a warranty service please supply proof of purchase and a brief explanation of the fault.

WATERSNAKE®

CONTACT INFORMATION

REGION/COUNTRY	DISTRIBUTOR	PHONE
Asia Pacific		
Australia	Jarvis Walker	+61 3 8787 6900
(Tasmania)	Tas Fishing Supplies	+61 3 6248 5959
(West Australia)	Benbow Outdoors	+61 8 9302 5552
China	Jarvis Walker International	+86 21 6356 5078
New Zealand	Thompson Walker	+64 9 274 7740
USA		
	Watersnake Motors Inc.	+1 239 481 5649
Africa		
South Africa	Apex Walker	+27 11 7920 611
Russia		
	Badger Ltd.	+7 812 321 8880
Europe		
Austria	Aquazona	+420 386 357 881
Belgium	SPRO BV	+31 347 320 888
Bosnia	Aquazona	+420 386 357 881
Bulgaria	Aquazona	+420 386 357 881
Czech Republic	Aquazona	+420 386 357 881
Denmark	Wiggler AB	+0303 798 744
Finland	Wiggler AB	+0303 798 744
France	SPRO BV	+31 347 320 888
Germany	SPRO BV	+31 347 320 888
Hungary	SPRO BV	+31 347 320 888
Ireland	Truetackle	+353 1 295 8255
Italy	Europesca Sport	+39 06 6500 2449
Luxembourg	SPRO BV	+31 347 320 888
Montenegro	Aquazona	+420 386 357 881
Netherlands	SPRO BV	+31 347 320 888
Norway	Wiggler AB	+0303 798 744
Poland	SPRO BV	+31 347 320 888
Romania	Aquazona	+420 386 357 881
Serbia	Aquazona	+420 386 357 881
Slovakia	Aquazona	+420 386 357 881
Slovenia	Aquazona	+420 386 357 881
Sweden	Wiggler AB	+0303 798 744
Turkey	TURAC Dist.	+90 532 707 8430
United Kingdom	Masterline Walker	+44 0 1684 299 000

AUSTRALIAN REPAIRS AND SERVICING
Anglers' Central Service Centre
2/7 Circuit Drive, Hendon
South Australia, 5014 Australia

Ph: 08 8244 8790

Email: spareparts@anglerscentral.com.au

www.jarviswalker.com.au

Jarvis Marine International Pty. Ltd.
297-305 South Gippsland Highway
Dandenong South, Victoria 3175 Australia
ACN: 133 252 294

Watersnake® and Jarvis Marine® are registered trademarks of Jarvis Marine International.

© 2009 Jarvis Marine International. All Rights Reserved.
Specifications are subject to change without notice.