

## DYNAMIC RGB LED LIGHTED WHIP with QUICK DISCONNECT

Before you start, read directions completely.  
If your vehicle is not pre-wired for external lighting,  
you may need the following:

- In-line Fuse Holder (SPXATC16 or similar)
- 3 Amp Fuse
- 2 Strand Primary Wire
- Wire Connectors / Solder
- Wire Cover
- Zip-Ties

### Optional:

- Switch
- Relay

The SPXDW4 Dynamic RGB Whip requires a  
Dynamic RGB Controller which is sold separately  
(SPXDBTC) or can be added to the SPXDK4 or SPXDK8

1. Mount the base in desired location. The base requires a 1/2" / 13mm mounting hole.
2. Connect extension wire to the Red and Black wires and route wiring to the battery or switch / relay location.
3. Refer to diagrams for wiring.

**Diagram 1:** Wiring direct to power and using remote control to turn on/off. Must add 3 AMP fuse on RED 12V+ wire.

**Diagram 2:** Wiring with a switch. You can add a new dedicated switch or use an existing light switch that outputs 12V+ when ON. You will need to add a 3 AMP fuse on the RED 12V+ wire and also requires a 12V relay.



4. Attach whip and test.  
To attach or release the whip from the base, pull up on the locking collar.

### WHAT'S INCLUDED

- 4" Dynamic LED Whip
- Mounting Base
- 10ft Extension cable
- Flag
- Zip-Tie for Flag
- Mounting Base Cap

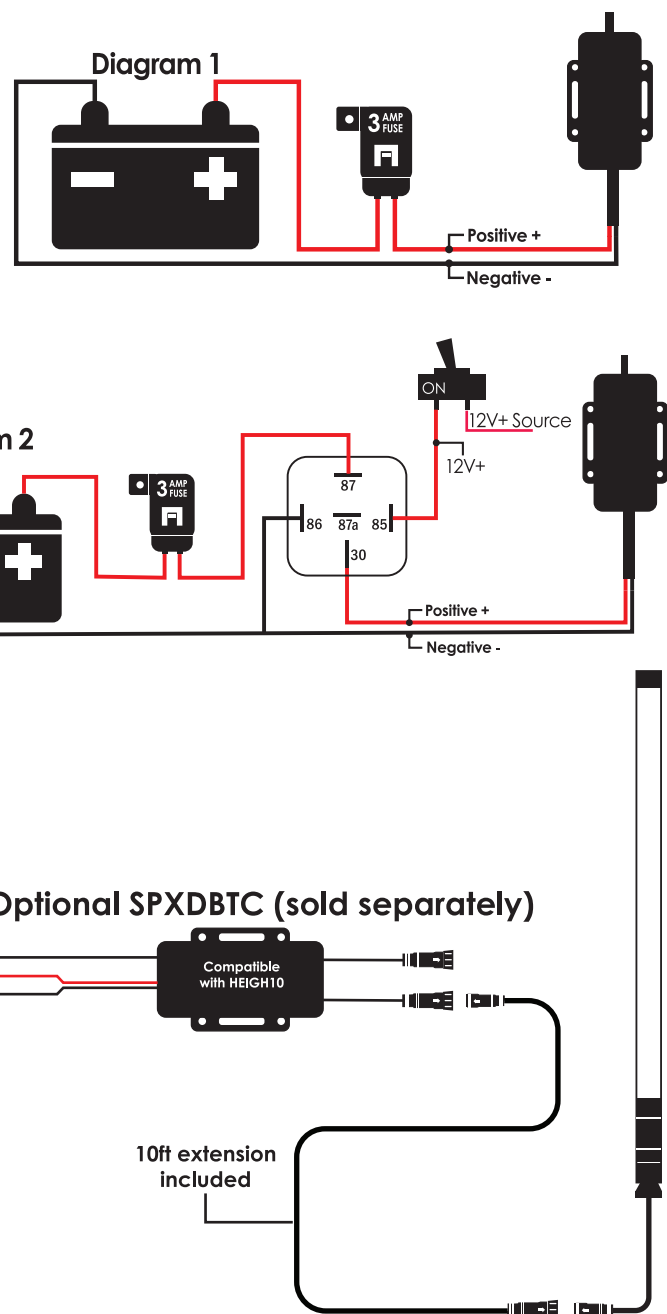

Stinger

# ENLIGHT10

## SPXDW4

When whip is not attached to base, use supplied cap to keep dirt and debris out of connector.



Use Zip Ties to secure Flag to the whip

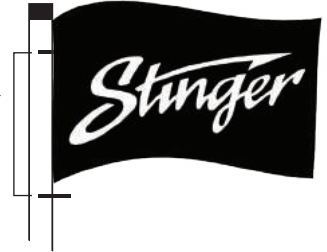

## Available Stinger Dynamic RGB Controller (Sold Separately)

### SPXDBTC

Controls up to two Dynamic RGB Whips via Bluetooth and App, includes RF remote.

### GET THE APP

Scan the QR Code, or visit Google Play or iTunes to download the **enLIGHT10** app. Once the app is installed, power up the RGB Module and open the app. The module should auto-connect and be listed in the device list. And Jon says Let There Be Light.



SCAN for Apple iOS and Android App

- Device Group List
- Choose LED color
- Choose LED patterns and colors
- Make custom LED color and patterns
- Play lights from internal audio file, or microphone
- App settings

Menu Button

Power Button

Stinger Lighting App

### LIMITED WARRANTY:

Stinger warrants this product to be free of defects in materials and workmanship for a period of one (1) years from the original date of purchase. This warranty is not transferable and applies only to the original purchaser from an authorized Stinger dealer in the United States of America only. Should service be necessary under this warranty for any reason due to manufacturing defect or malfunction, Stinger will (at its discretion), repair or replace the defective product with new or re-manufactured product at no charge. Damage caused by the following is not covered under warranty: accident, misuse, abuse, product modification or neglect, failure to follow installation instructions, unauthorized repair attempts, misrepresentations by the seller. This warranty does not cover incidental or consequential damages and does not cover the cost of removing or reinstalling the unit(s). Cosmetic damage due to accident or normal wear and tear is not covered under warranty.

### INTERNATIONAL WARRANTIES:

Products purchased outside the United States of America are covered only by that country's Authorized Stinger reseller and not by Stinger. Consumers needing service or warranty information for these products must contact that country's reseller for information.



Stinger is a Power Brand of AAMP Global  
15500 Lightwave, Clearwater, Florida 33760  
P: 888-228-5560

support@stingerelectronics.com  
www.stingerelectronics.com

© 2018 Stinger

When adding multiple light kits together you will need to adjust the pixel count using the enLIGHT10 phone app.

Below are the pixel count for each part and on page 2 you will find the Steps and the Pixel Calculator.

Each SPXDBTC has a pixel count min and max

Minimum 30

Maximum 1024

Rock Lights = 4 pixels per Rock Light

For example:

1 SPXDK4 (4 Rock Lights) = 16 pixels. **(App supports min 30 pixels)**

1 SPXDK8 (8 Rock Lights) = 32 pixels.

Whips and Light Strips are treated as left/right pairs so pixel count is for two units.

For example:

2 SPXDW4 (Whips) = 108 Pixels total.

2 SPXD5 (Light Strips) = 100 pixels total.

If you were to have three or four Whips you would enter  $108 \times 2 = 216$  pixels.

If you were to have three or four Light Strips you would enter  $100 \times 2 = 200$  pixels.

### Product Pixel Count:

#### SPXDK4

4 Rock Light Kit = 16 pixels

App is preset to 30 pixels



#### SPXDK8

8 Rock Light Kit = 32 pixels

App is preset to 32 pixels



#### SPXDE4

4 Add on Rock Lights = 16 pixels

Add 16 pixels for each kit



#### SPXD5

5 Meter LED Strip = 100 pixels

Add 100 pixels for one or two strips



#### SPXDUBKIT

6 LED Light Strip Kit = 50 pixels

App is preset to 50 pixels



#### SPXDW4

4ft Whip = 108 pixels

Set App to 108 pixels for one or two Whips



## Step 1.

Open the enLIGHT10 app on your phone.

## Step 2.

Open the **Settings** menu.

## Step 3.

Click on **Chasing Setting**.

## Step 4.

Click on **the device**.

The device should now be highlighted in blue.

If you have a kit the device name will have a preset pixel count (SPXDK4 = 30, SPXDK8 =32, SPXDUBKIT = 50).

## Step 5.

Enter the number of pixels you want and press enter.

## Step 6.

Go to the Mode page and turn the connected device off then on by pressing the Green icon.

## Pixel Calculator

Rock Light = 4 pixels each

LED strip per 2 inches = 1 pixel

For example:

12 Inch strip = 6 pixels

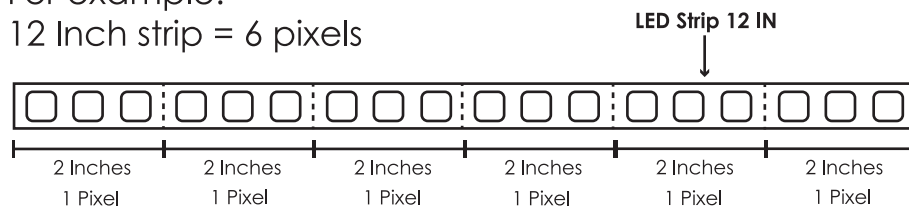

2

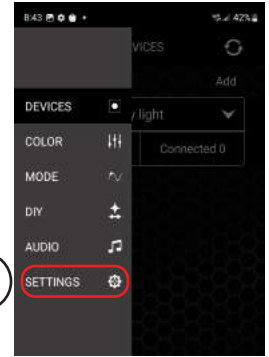

3

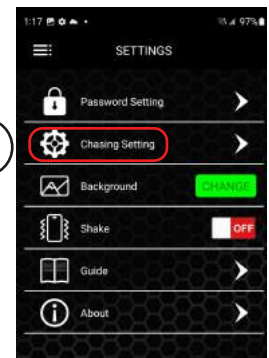

4

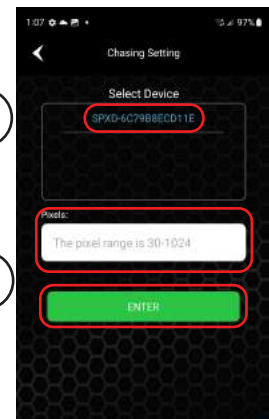

5

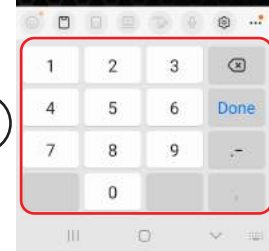

5

6

