

GENERAL SURGERY
— RANGE

DISCOVER NOW

“Instruments for
surgical procedures”
Since 1970



TECHNIMEN AGHA
LIMITED UK

“INSTRUMENTS FOR SURGICAL PROCEDURES”

OUR SERVICES

Scissors
Orthopedics
Plastic Surgery
Neuro Surgery
General Surgery
Gynecology, ENT
Dental instruments,
Cardiovascular instruments



OUR TEAM



Production Space
53,500 Ft²

COUNTRIES



Footprints In
More Than
16 Countries

OEM & ODM



Production Capabilities
State Of The Art
Vacuum Hardening
CNC Milling Facility

SCALPELS

— RANGE

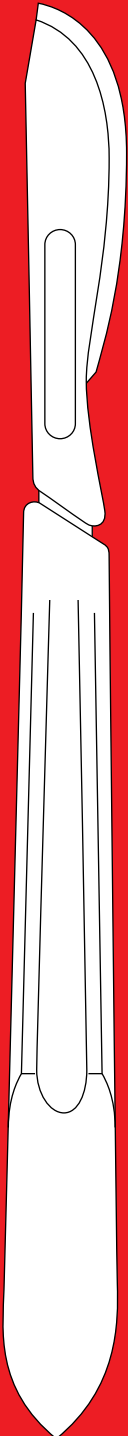

DISCOVER NOW

“Instruments for
surgical procedures”
Since 1970

SCALPELS



Scalpels, knives, dermatome

Dissecting scalpel

Material: Stainless steel

Other Sizes:

001-0002-01	15 cm
001-0002-02	15 cm
001-0002-03	15.5 cm
001-0002-04	16 cm
001-0002-05	16 cm



Scalpels, knives, dermatome

Dissecting scalpel

Material: Stainless steel

Other Sizes:

001-0002-06	15 cm
001-0002-07	15 cm
001-0002-08	16 cm
001-0002-09	16 cm
001-0002-10	17 cm



Scalpels, knives, dermatome

Brain knife, acc. to Virchow

Material: Stainless steel

Other Sizes:

001-0038-16	26 cm
001-0038-20	33.5 cm
001-0038-24	38 cm



Scalpels, knives, dermatome

Bladeholder, acc. to Troutman-Chris, straight

Material: Stainless steel

Other Sizes:

001-0090-09	9 cm
-------------	------



Scalpels, knives, dermatome

Bladeholder, acc. to Troutman-Chris, angled

Material: Stainless steel

Other Sizes:

001-0091-09	9 cm
-------------	------



Scalpels, knives, dermatome

Bladebreaker and -holder

Material: Stainless steel

Other Sizes:

001-0092-11	11 cm
-------------	-------

SCALPELS



Scalpels, knives, dermatome
Bladeholder, acc. to Castroviejo

Material: Stainless steel

Other Sizes:
001-0094-13 : 15 cm



Scalpels, knives, dermatome
Razor blades, breakable, 10 pieces

Material: Stainless steel

Other Sizes:
001-0096-00 : N/A



Scalpels, knives, dermatome
Scalpel Handle, no. 4

Material: Stainless steel

Other Sizes:
001-0100-04 : 13.5 cm



Scalpels, knives, dermatome
Scalpel Handle, no. 3 & 4

Material: Stainless steel

Other Sizes:
001-0100-34 : 16 cm



Scalpels, knives, dermatome
Scalpel Handle, no. 4L

Material: Stainless steel

Other Sizes:
001-0104-41 : 21 cm



Scalpels, knives, dermatome
Scalpel Handle, no. 4L

Material: Stainless steel

Other Sizes:
001-0104-45 : 21 cm

SCALPELS



Scalpels, knives, dermatome
Scalpel Handle, acc. to Collin, no. 8

Material: Stainless steel

Other Sizes:
001-0108-08 : 13.5 cm



Scalpels, knives, dermatome
Scalpel Handle, acc. to Collin, no. 9

Material: Stainless steel

Other Sizes:
001-0109-09 : 14.5 cm



Scalpels, knives, dermatome
Scalpel Handle, plastic

Material: Stainless steel

Other Sizes:
001-0112-04 : 13.5 cm



Scalpels, knives, dermatome
Scalpel Handle, 1.0/1.5 mm,
for 2 blades

Material: Stainless steel

Other Sizes:
001-0116-03 : 1.0/1.5 mm



Scalpels, knives, dermatome
Scalpel Handle, 1.5/2.0 mm,
or 2 blades

Material: Stainless steel

Other Sizes:
001-0117-03 : 1.5/2.0 mm



Scalpels, knives, dermatome
Swivel head scalpel Handle

Material: Stainless steel

Other Sizes:
001-0118-03 : 15.5 cm

SCALPELS



Scalpels, knives, dermatome

Scalpel Handle, no. 3

Material: Stainless steel

Other Sizes:
001-0120-04 : 16 cm

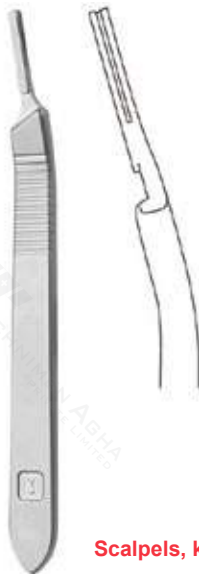

Scalpels, knives, dermatome

Scalpel Handle, no. 3, left, 5D

Material: Stainless steel

Other Sizes:
001-0125-01 : 12 cm



Scalpels, knives, dermatome

Scalpel Handle, no. 3, right, 5D

Material: Stainless steel

Other Sizes:
001-0125-02 : 12 cm



Scalpels, knives, dermatome

Scalpel Handle, no. 3

Material: Stainless steel

Other Sizes:
001-0130-03 : 12 cm



Scalpels, knives, dermatome

Scalpel Handle, no. 4

Material: Stainless steel

Other Sizes:
001-0130-04 : 12 cm



Scalpels, knives, dermatome

Scalpel Handle, no. 3

Material: Stainless steel

Other Sizes:
001-0130-05 : 12 cm

SCALPELS



Scalpels, knives, dermatome

Scalpel Handle, no. 3L, long

Material: Stainless steel

Other Sizes:

001-0133-31 : 21.5 cm



Scalpels, knives, dermatome

Scalpel Handle, no. 3L, Ang.

Material: Stainless steel

Other Sizes:

001-0133035 : 21 cm



Scalpels, knives, dermatome

Scalpel Handle, no. 3 x L

Material: Stainless steel

Other Sizes:

001-0135-01 : 26 cm



Scalpels, knives, dermatome

Scalpel Handle, no. 7 & 7k, solid

Material: Stainless steel

Other Sizes:

001-0137-07 : 16 cm



Scalpels, knives, dermatome

Scalpel Handle, no. 7 & 7k, solid

Material: Stainless steel

Other Sizes:

001-0137-71 : 12.5



Scalpels, knives, dermatome

Scalpel Handle, round, no. 3

Material: Stainless steel

Other Sizes:

001-0140-03 : 15.5 cm

SCALPELS



Scalpels, knives, dermatome
Scalpel Handle, plastic, no. 3

Material: Stainless steel

Other Sizes:
001-0142-03 : 12.5 cm



Scalpels, knives, dermatome
Scalpel Handle, round, straight, no. 3

Material: Stainless steel

Other Sizes:
001-0146-03 : 14.5 cm



Scalpels, knives, dermatome
Scalpel Handle, round, angled no. 3

Material: Stainless steel

Other Sizes:
001-0147-03 : 14 cm



Scalpels, knives, dermatome
Scalpel Handle, acc. to acc. to Kaye, round, no. 3

Material: Stainless steel

Other Sizes:
001-0148-03 : 15 cm



Scalpels, knives, dermatome
Scalpel blade, no. 10, non sterile/ sterile

Material: all other, not specially marked material types

Other Sizes:
001-0150-10 : N/A
001-0155-10 : N/A



Scalpels, knives, dermatome
Scalpel blade, no. 11, non sterile/ sterile

Material: all other, not specially marked material types

Other Sizes:
001-0150-11 : N/A
001-0155-11 : N/A

SCALPELS



Scalpels, knives, dermatome
Scalpel blade, no. 13, non sterile / sterile

Material: all other, not specially marked material types

Other Sizes:	
001-0150-13	N/A
001-0155-13	N/A



Scalpels, knives, dermatome
Scalpel blade, no. 12, non sterile / sterile

Material: all other, not specially marked material types

Other Sizes:	
001-0150-12	N/A
001-0155-12	N/A

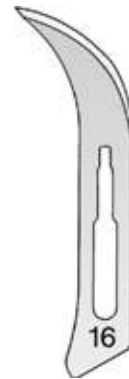

Scalpels, knives, dermatome
Scalpel blade, no. 16, non sterile

Material: all other, not specially marked material types

Other Sizes:	
001-0150-16	N/A
001-0155-16	N/A



Scalpels, knives, dermatome
Scalpel blade, no. 17, non sterile / sterile

Material: all other, not specially marked material types

Other Sizes:	
001-0150-17	N/A
001-0155-17	N/A



Scalpels, knives, dermatome
Scalpel blade, no. 18, non sterile / sterile

Material: all other, not specially marked material types

Other Sizes:	
001-0150-18	N/A
001-0155-18	N/A

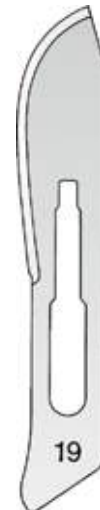

Scalpels, knives, dermatome
Scalpel blade, no. 19, non sterile

Material: all other, not specially marked material types

Other Sizes:	
001-0150-19	N/A
001-0155-19	N/A

SCALPELS

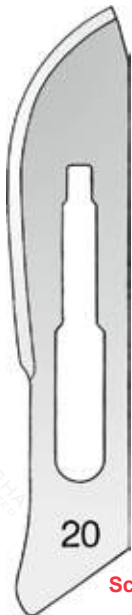

Scalpels, knives, dermatome
Scalpel blade, no. 20, non sterile

Material: all other, not specially marked material types

Other Sizes:	
001-0150-20	N/A
001-0155-20	N/A

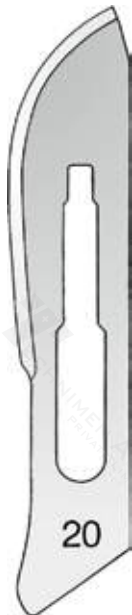

Scalpels, knives, dermatome
Scalpel blade, no. 20, non sterile

Material: all other, not specially marked material types

Other Sizes:	
001-0150-21	N/A
001-0155-21	N/A



Scalpels, knives, dermatome
Scalpel blade, no. 22, non sterile / sterile

Material: all other, not specially marked material types

Other Sizes:	
001-0150-22	N/A
001-0155-22	N/A



Scalpels, knives, dermatome
Scalpel blade, no. 23, non sterile / sterile

Material: all other, not specially marked material types

Other Sizes:	
001-0150-23	N/A
001-0155-23	N/A



Scalpels, knives, dermatome
Scalpel blade, no. 24, non sterile / sterile

Material: all other, not specially marked material types

Other Sizes:	
001-0150-24	N/A
001-0155-24	N/A



Scalpels, knives, dermatome
Scalpel blade, no. 34, non sterile / sterile

Material: all other, not specially marked material types

Other Sizes:	
001-0150-34	N/A
001-0155-34	N/A

SCALPELS



Scalpels, knives, dermatome
Scalpel blade, no. 36, non sterile / sterile

Material: all other, not specially marked material types

Other Sizes:	
001-0150-36	N/A
001-0155-36	N/A

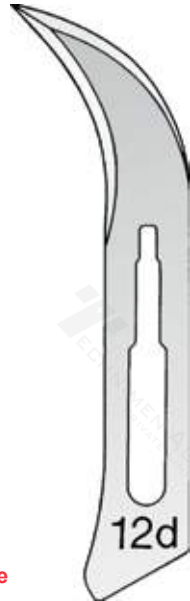

Scalpels, knives, dermatome
Scalpel blade, no. 12D, non sterile / sterile

Material: all other, not specially marked material types

Other Sizes:	
001-0151-12	N/A
001-0156-12	N/A



Scalpels, knives, dermatome
Scalpel blade, no. 15C, non sterile / sterile

Material: all other, not specially marked material types

Other Sizes:	
001-0151-15	N/A
001-0156-15	N/A



Scalpels, knives, dermatome
Saw blade, sterile, 1 piece

Material: all other, not specially marked material types

Other Sizes:	
001-0155-09	N/A



Scalpels, knives, dermatome
Scalpel blade, no. 15, non sterile / sterile

Material: all other, not specially marked material types

Other Sizes:	
001-0150-15	N/A
001-0155-15	N/A



Scalpels, knives, dermatome
Ti scalpel Handle for micro blade, 13.5 cm

Material: Materititanium

Other Sizes:	
001-0159-00	13,5 cm

SCALPELS



Scalpels, knives, dermatome

Scalpel blade for micro blade

Material: Stainless steel

Other Sizes:

001-0160-01 : 13.5 cm



Scalpels, knives, dermatome

Disposable scalpel, no. 18, sterile

Material: all other, not specially marked material types

Other Sizes:

001-0285-18 : N/A



Scalpels, knives, dermatome

Disposable scalpel, no. 19, sterile

Material: all other, not specially marked material types

Other Sizes:

001-0285-19 : N/A



Scalpels, knives, dermatome

Disposable scalpel, no. 20, sterile

Material: all other, not specially marked material types

Other Sizes:

001-0285-20 : N/A



Scalpels, knives, dermatome

Disposable scalpel, no. 21, sterile

Material: all other, not specially marked material types

Other Sizes:

001-0285-21 : N/A



Scalpels, knives, dermatome

Disposable scalpel, no. 22, sterile

Material: all other, not specially marked material types

Other Sizes:

001-0285-22 : N/A

SCALPELS



Scalpels, knives, dermatome
Disposable scalpel, no. 23, sterile

Material: all other, not specially marked material types

Other Sizes:
001-0285-23 N/A



Scalpels, knives, dermatome
Disposable scalpel, no. 24, sterile

Material: all other, not specially marked material types

Other Sizes:
001-0285-24 N/A



Scalpels, knives, dermatome
Disposable scalpel, no. 10, sterile

Material: all other, not specially marked material types

Other Sizes:
001-0295-10 N/A



Scalpels, knives, dermatome
Disposable scalpel, no. 11, sterile

Material: all other, not specially marked material types

Other Sizes:
001-0295-11 N/A



Scalpels, knives, dermatome
Disposable scalpel, no. 12, sterile

Material: all other, not specially marked material types

Other Sizes:
001-0295-12 N/A



Scalpels, knives, dermatome
Disposable scalpel, no. 13, sterile

Material: all other, not specially marked material types

Other Sizes:
001-0295-13 N/A

SCALPELS



Scalpels, knives, dermatome
Disposable scalpel, no. 15, sterile

Material: all other, not specially marked material types

Other Sizes:
001-0295-15 : N/A



Scalpels, knives, dermatome
Disposable scalpel, no. 12D, sterile

Material: all other, not specially marked material types

Other Sizes:
001-0296-12 : N/A



Scalpels, knives, dermatome
Disposable scalpel, no. 15C, sterile

Material: all other, not specially marked material types

Other Sizes:
001-0296-15 : N/A



Scalpels, knives, dermatome
Amputating knife, cut 160 mm

Material: Stainless steel

Other Sizes:
001-0500-16 : 29 cm



Scalpels, knives, dermatome
Amputating knife, cut 190 mm

Material: Stainless steel

Other Sizes:
001-0500-19 : 32 cm



Scalpels, knives, dermatome
Resection knife, solid

Material: Stainless steel

Other Sizes:
001-0560-06 : 19 cm

SCALPELS



Scalpels, knives, dermatome

Resection knife, round

Material: Stainless steel

Other Sizes:
001-0570-05 : 18 cm



Scalpels, knives, dermatome

Resection knife, round

Material: Stainless steel

Other Sizes:
001-0572-05 : 18 cm



Scalpels, knives, dermatome

Razor knife, konkave blade

Material: Stainless steel

Other Sizes:
001-0800-00 : 75 mm



Scalpels, knives, dermatome

Razor knife, flat/hollow

Material: Stainless steel

Other Sizes:
001-80811-00 : 80 mm



Scalpels, knives, dermatome

Oil stone, Arkansas

Material: all other, not specially marked material types

Other Sizes:
001-0875-00 : 150 x 50 mm



Scalpels, knives, dermatome

Oil stone, Arkansas, small

Material: all other, not specially marked material types

Other Sizes:
01-0877-00 : N/A

SCALPELS



Scalpels, knives, dermatome
Dermatome, acc. to Humby,
Complete

Material: Stainless steel

Other Sizes:
001-0878-00 : 32 cm



Scalpels, knives, dermatome
Spare Blade for 001-0878-00

Material: Stainless steel

Other Sizes:
001-0878-01 : N/A



Scalpels, knives, dermatome
Dermatome, acc. to Schink,
complete

Material: Stainless steel

Other Sizes:
001-0880-00 : 30 cm



Scalpels, knives, dermatome
Spare Blade for 001-0880-00

Material: Stainless steel

Other Sizes:
001-0880-01 : N/A



Scalpels, knives, dermatome
Skinstraightening plate for
001-0880-00

Material: Stainless steel

Other Sizes:
001-0880-02 : N/A



Scalpels, knives, dermatome
Dermatome, silver

Material: Stainless steel

Other Sizes:
001-0882-19 : 19.5 cm

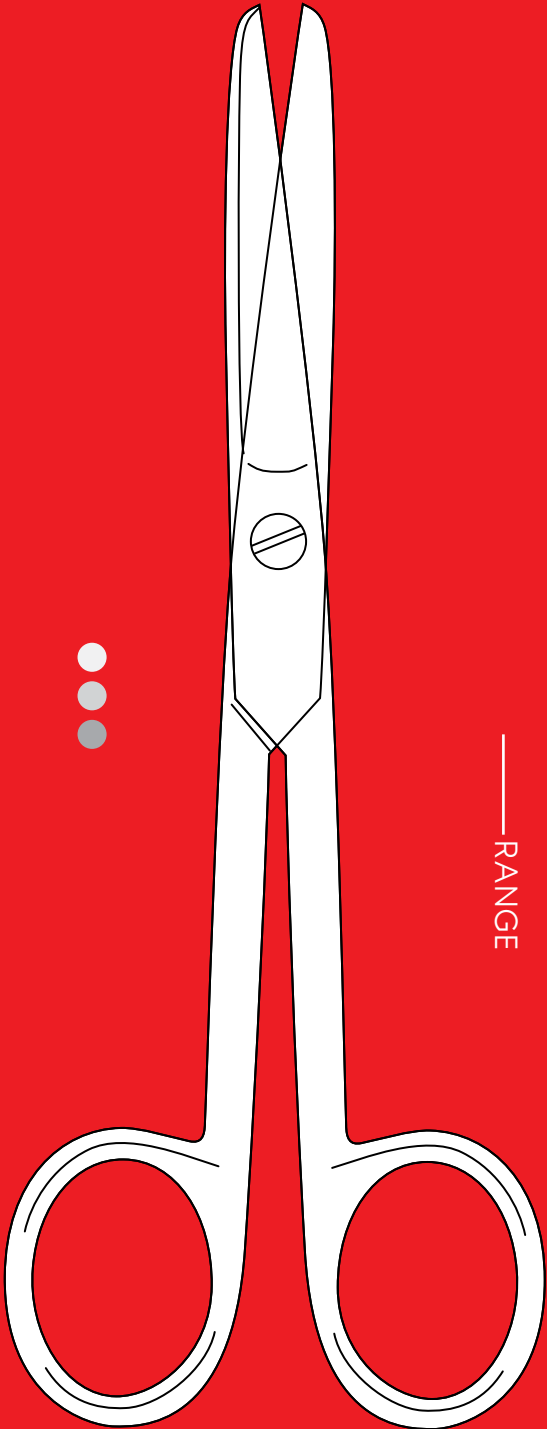

SCISSORS

— RANGE

DISCOVER NOW

“Instruments for
surgical procedures”
Since 1970

SCISSORS

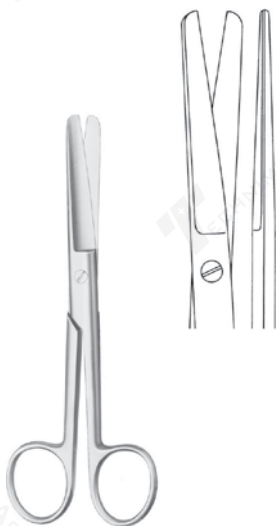

Scissors

Operating scissors, blunt/blunt, straight

Material: Stainless steel

Other Sizes:

002-0100-11	12 cm
002-0100-13	13 cm
002-0100-14	14.5 cm
002-0100-15	15.5 cm
002-0100-16	16.5 cm
002-0100-17	17.5 cm
002-0100-18	18.5 cm
002-0100-20	20.5 cm

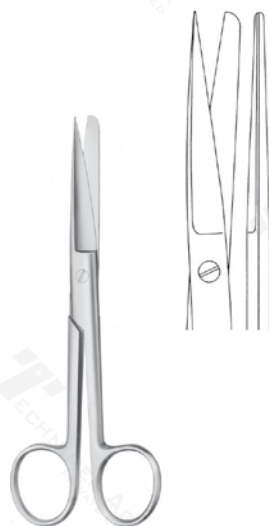

Scissors

Operating scissors, pointed/blunt, straight

Material: Stainless steel

Other Sizes:

002-0102-11	12 cm
002-0102-13	13 cm
002-0102-14	14.5 cm
002-0102-16	16.5 cm
002-0102-18	18.5 cm
002-0102-20	20.5 cm
002-0102-15	15.5 cm
002-0102-17	17.5 cm

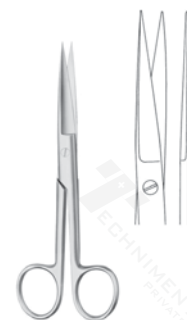

Scissors

Operating scissors, pointed/pointed, straight

Material: Stainless steel

Other Sizes:

002-0104-11	12 cm
002-0104-13	13 cm
002-0104-14	14.5 cm
002-0104-16	16.5 cm
002-0104-15	15.5 cm



Scissors

Operating scissors, blunt/blunt, curved

Material: Stainless steel

Other Sizes:

002-0105-11	12 cm
002-0105-13	13 cm
002-0105-14	14.5 cm
002-0105-16	16.5 cm
002-0105-18	18.5 cm
002-0105-20	20.5 cm
002-0105-15	15.5 cm
002-0105-17	17.5 cm



Scissors

Operating scissors, pointed/blunt, curved

Material: Stainless steel

Other Sizes:

002-0107-11	12 cm
002-0107-13	13 cm
002-0107-14	14.5 cm
002-0107-16	16.5 cm
002-0107-18	18.5 cm
002-0107-20	20.5 cm
002-0107-15	15.5 cm
002-0107-17	17.5 cm



Scissors

Operating scissors, pointed/pointed, curved

Material: Stainless steel

Other Sizes:

002-0109-11	12 cm
002-0109-13	13 cm
002-0109-14	14.5 cm
002-0109-16	16.5 cm
002-0109-15	15.5 cm

SCISSORS



Scissors

Scissors, delicate, blunt/blunt, straight,

Material: Stainless steel

Other Sizes:

002-0120-13	13 cm
002-0120-14	14.5 cm

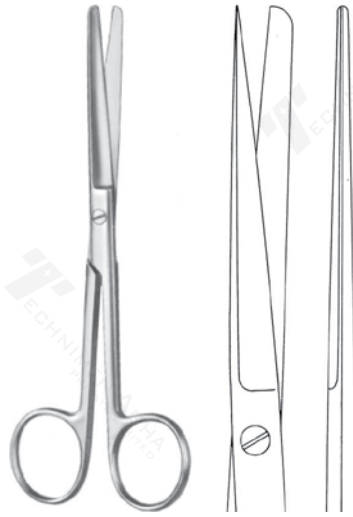

Scissors

Scissors, delicate, pointed/blunt, straight

Material: Stainless steel

Other Sizes:

002-0122-13	13 cm
002-0122-14	14.5 cm

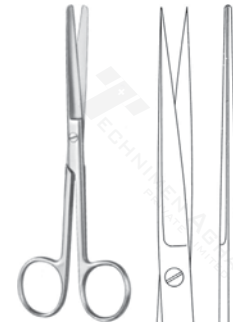

Scissors

Scissors, delicate, pointed/pointed, straight

Material: Stainless steel

Other Sizes:

002-0124-13	13 cm
002-0124-14	14.5 cm

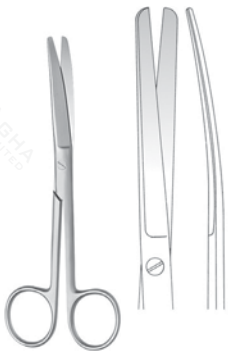

Scissors

Scissors, delicate, blunt/blunt, curved

Material: Stainless steel

Other Sizes:

002-0125-14	14.5 cm
-------------	---------



Scissors

Scissors, delicate, pointed/blunt, curved

Material: Stainless steel

Other Sizes:

002-0127-13	13 cm
002-0127-14	14.5 cm



Scissors

Scissors, delicate, pointed/pointed, curved

Material: Stainless steel

Other Sizes:

002-0129-13	13 cm
002-0129-14	14.5 cm

SCISSORS

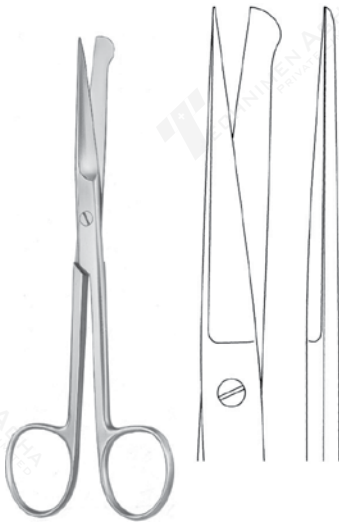

Scissors

Incision Scissors, straight

Material: Stainless steel

Other Sizes:

002-0136-14 14.5 cm



Scissors

Scissors, acc. to Deaver
pointed/blunt, straight

Material: Stainless steel

Other Sizes:

002-0140-14 14 cm



Scissors

Scissors, acc. to Deaver
pointed/blunt, curved

Material: Stainless steel

Other Sizes:

002-0141-14 14 cm

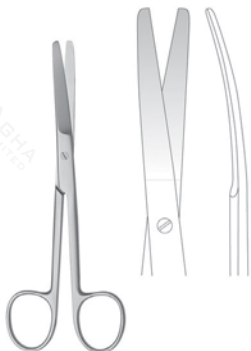

Scissors

Scissors, acc. to Deaver
blunt/blunt, curved

Material: Stainless steel

Other Sizes:

002-0142-15 14.5 cm



Scissors

Scissors, acc. to acc. to Mayo, straight

Material: Stainless steel

Other Sizes:

002-0170-14 14.5 cm
002-0170-15 15 cm
002-0170-17 17 cm
002-0170-23 23.5 cm

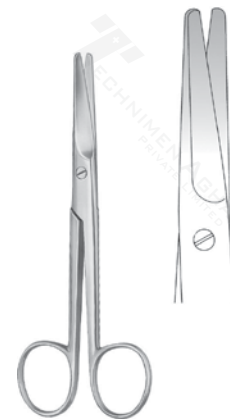

Scissors

Scissors, acc. to acc. to Mayo, curved

Material: Stainless steel

Other Sizes:

002-0171-14 14.5 cm
002-0171-15 15 cm
002-0171-17 17 cm
002-0171-23 23.5 cm

SCISSORS

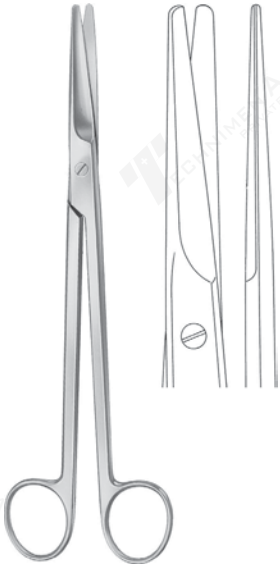

Scissors

Scissors, acc. to acc. to Mayo-Harrington, straight

Material: Stainless steel

Other Sizes:

002-0174-22 23 cm

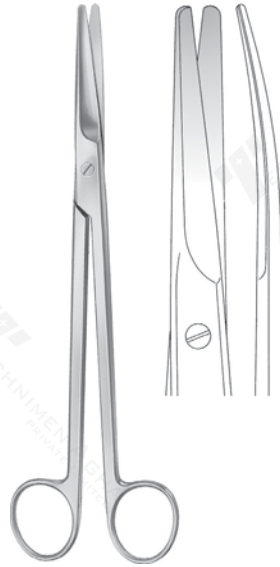

Scissors

Scissors, acc. to acc. to Mayo-Harrington, curved

Material: Stainless steel

Other Sizes:

002-0175-22 22 cm
002-0175-30 28 cm

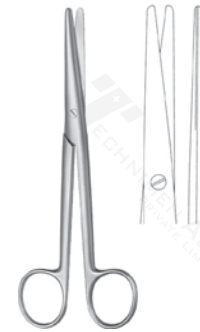

Scissors

Scissors, acc. to acc. to Mayo-Stillie, straight

Material: Stainless steel

Other Sizes:

002-0180-15 15 cm
002-0180-17 17 cm

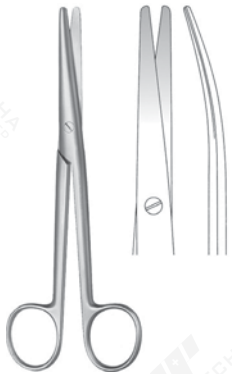

Scissors

Scissors, acc. to acc. to Mayo-Stillie, curved

Material: Stainless steel

Other Sizes:

002-0181-15 15 cm
002-0181-17 17 cm



Scissors

Scissors, acc. to acc. to Mayo-Stillie, straight

Material: Stainless steel

Other Sizes:

002-0184-16 16 cm
002-0184-19 19.5 cm
002-0184-21 21.5 cm

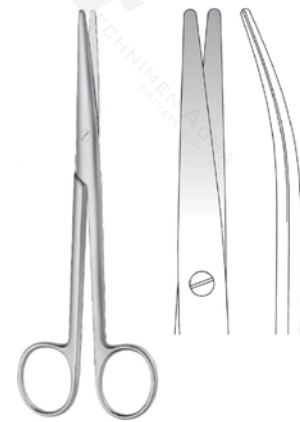

Scissors

Scissors, acc. to acc. to Mayo-Stillie, curved

Material: Stainless steel

Other Sizes:

002-0185-16 16 cm
002-0185-19 19.5 cm
002-0185-21 21.5 cm

SCISSORS

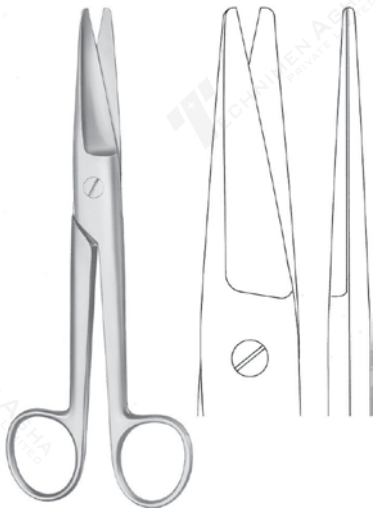

Scissors

Scissors, acc. to acc. to Mayo-Noble, straight

Material: Stainless steel

Other Sizes:

002-0190-17 : 16.5 cm



Scissors

Scissors, acc. to acc. to Mayo-Noble, curved

Material: Stainless steel

Other Sizes:

002-0191-17 : 16.5 cm



Scissors

Scissors, acc. to acc. to Sims, blunt/blunt, straight

Material: Stainless steel

Other Sizes:

002-0200-20 : 20 cm
002-0200-23 : 23 cm



Scissors

Scissors, acc. to acc. to Mayo-Stille, curved

Material: Stainless steel

Other Sizes:

002-0203-20 : 20 cm
002-0203-23 : 23 cm



Scissors

Scissors, acc. to Kelly, straight

Material: Stainless steel

Other Sizes:

002-0226-16 : 16 cm

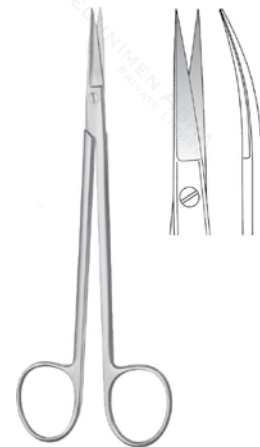

Scissors

Scissors, acc. to Kelly, curved

Material: Stainless steel

Other Sizes:

002-0227-16 : 16 cm

SCISSORS

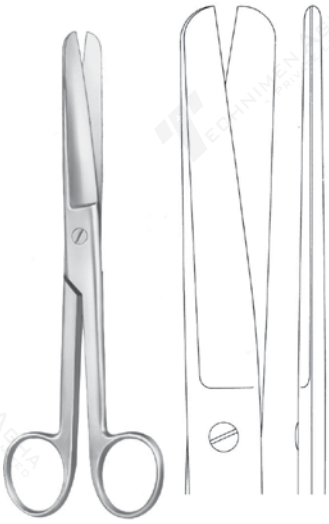

Scissors

Scissors, acc. to acc. to Doyen, blunt/blunt, straight

Material: Stainless steel

Other Sizes:

002-0230-17 : 18.5 cm



Scissors

Scissors, acc. to acc. to Doyen, blunt/blunt, curved

Material: Stainless steel

Other Sizes:

002-0231-17 : 18.5 cm



Scissors

Scissors, acc. to acc. to Sims-Siebold, straight

Material: Stainless steel

Other Sizes:

002-0232-24 : 24.5 cm

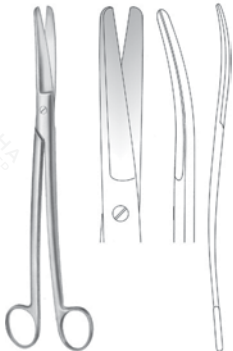

Scissors

Scissors, acc. to acc. to Sims-Siebold, curved

Material: Stainless steel

Other Sizes:

002-0233-24 : 24.5 cm

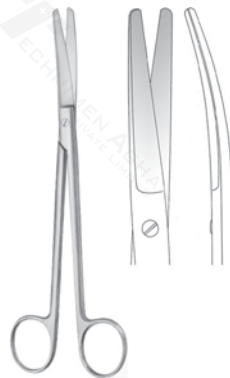

Scissors

Uterine scissors, curved

Material: Stainless steel

Other Sizes:

002-0235-20 : 20 cm
002-0235-23 : 23 cm

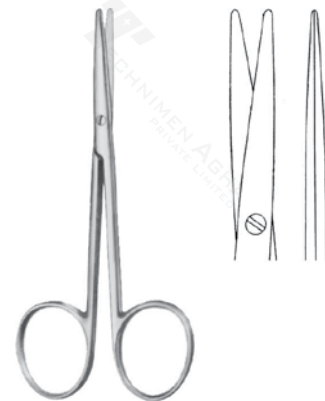

Scissors

Dissecting scissors, blunt/blunt, straight

Material: Stainless steel

Other Sizes:

002-0248-11 : 11.5 cm

SCISSORS



Scissors

Dissecting scissors,
blunt/blunt, curved

Material: Stainless steel

Other Sizes:

002-0249-11 : 11.5 cm

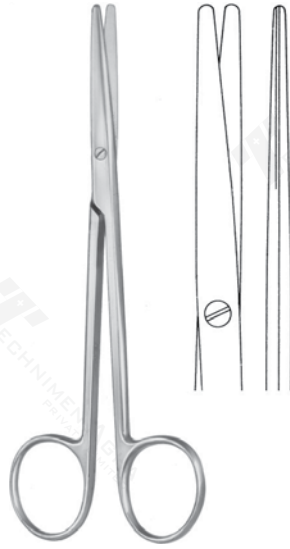

Scissors

Dissecting scissors,
blunt/blunt, straight

Material: Stainless steel

Other Sizes:

002-0250-14 : 14.5 cm



Scissors

Dissecting scissors,
pointed/blunt, straight

Material: Stainless steel

Other Sizes:

002-0252-14 : 14.5 cm



Scissors

Dissecting scissors,
pointed/pointed, straight

Material: Stainless steel

Other Sizes:

002-0254-14 : 14.5 cm



Scissors

Dissecting scissors,
blunt/blunt, curved

Material: Stainless steel

Other Sizes:

002-0255-14 : 14.5 cm



Scissors

Dissecting scissors,
pointed/blunt, curved

Material: Stainless steel

Other Sizes:

002-0257-14 : 14.5 cm

SCISSORS

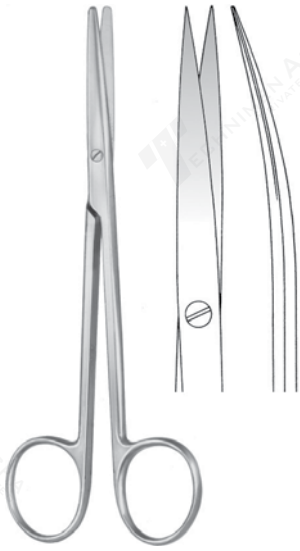

Scissors

Dissecting scissors,
pointed/pointed, curved

Material: Stainless steel

Other Sizes:

002-0259-14 : 14.5 cm

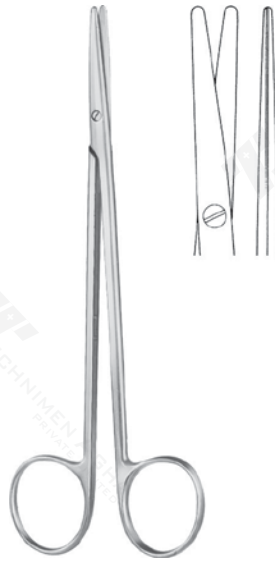

Scissors

Dissecting scissors,
blunt/blunt, straight

Material: Stainless steel

Other Sizes:

002-0264-15 : 15.5 cm



Scissors

Dissecting scissors,
blunt/blunt, curved

Material: Stainless steel

Other Sizes:

002-0265-15 : 15.5 cm



Scissors

Dissecting scissors, straight

Material: Stainless steel

Other Sizes:

002-0280-18 : 18 cm
002-0280-20 : 20.5 cm
002-0280-23 : 23 cm
002-0280-25 : 26 cm
002-0280-28 : 28.5 cm
002-0280-30 : 31 cm

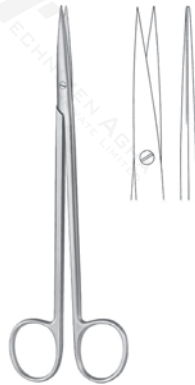

Scissors

Dissecting scissors,
pointed/pointed, straight

Material: Stainless steel

Other Sizes:

002-0284-18 : 18 cm
002-0284-20 : 20.5 cm

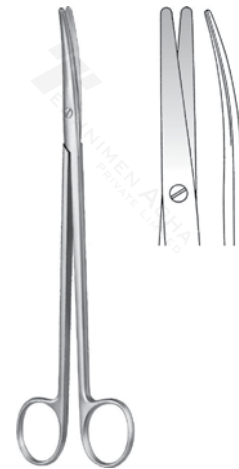

Scissors

Dissecting scissors, curved

Material: Stainless steel

Other Sizes:

002-0285-18 : 18 cm
002-0285-20 : 20.5 cm
002-0285-23 : 23 cm
002-0285-25 : 26 cm
002-0285-28 : 28.5 cm
002-0285-30 : 31 cm

SCISSORS

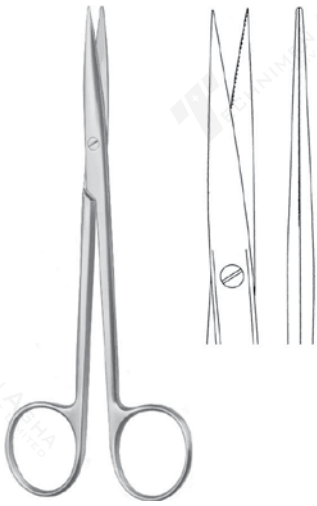

Scissors

Dissecting scissors,
serrated, straight

Material: Stainless steel

Other Sizes:

002-0298-14 : 14.5 cm

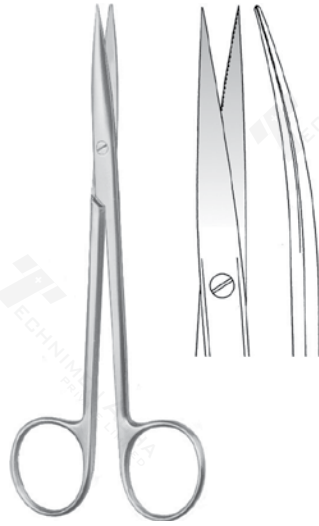

Scissors

Dissecting scissors,
serrated, curved

Material: Stainless steel

Other Sizes:

002-0299-14 : 14.5 cm



Scissors

Dissecting scissors,
pointed/pointed, straight

Material: Stainless steel

Other Sizes:

002-0300-15 : 15.5 cm



Scissors

Dissecting scissors,
pointed/pointed, curved

Material: Stainless steel

Other Sizes:

002-0301-15 : 15.5 cm

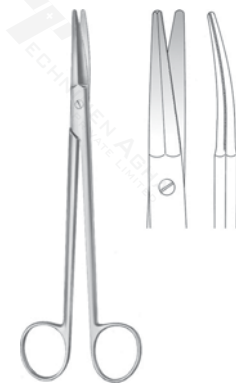

Scissors

Scissors, acc. to acc. to
Kaye, curved, serrated

Material: Stainless steel

Other Sizes:

002-0305-00 : 18.5 cm

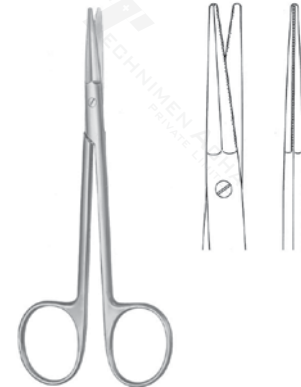

Scissors

Scissors, acc. to acc. to
Gorney, straight, serrated

Material: Stainless steel

Other Sizes:

002-0306-12 : 12.5 cm
002-0306-19 : 19.5 cm

SCISSORS



Scissors

Scissors, acc. to acc. to Gorney curved, serrated

Material: Stainless steel

Other Sizes:

002-0307-19 : 19.5 cm

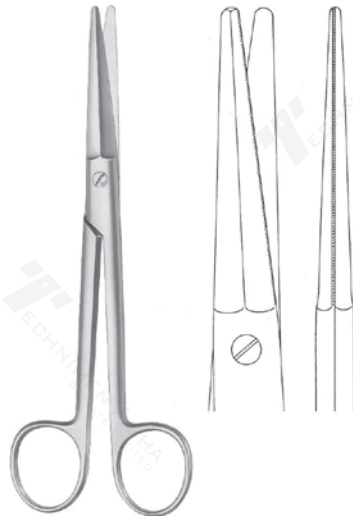

Scissors

Face-lift Scissors, acc. to Aston, straight

Material: Stainless steel

Other Sizes:

002-0308-17 : 17 cm

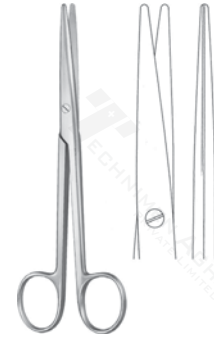

Scissors

Dissecting scissors, acc. to Lexer, straight

Material: Stainless steel

Other Sizes:

002-0310-16 : 16 cm

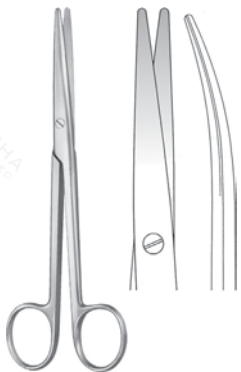

Scissors

Dissecting scissors, acc. to Lexer, curved

Material: Stainless steel

Other Sizes:

002-0311-16 : 16 cm

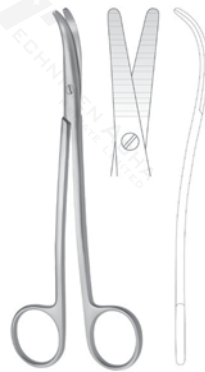

Scissors

Dissecting scissors, acc. to Hohenfellner

Material: Stainless steel

Other Sizes:

002-0313-18 : 18 cm
002-0313-21 : 21 cm
002-0313-24 : 24 cm

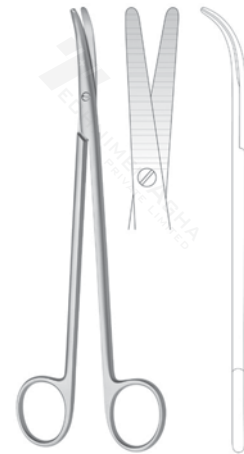

Scissors

Dissecting scissors, acc. to De Bakey

Material: Stainless steel

Other Sizes:

002-0315-17 : 17.5 cm
002-0315-20 : 20 cm

SCISSORS



Scissors

Nasal scissors, acc. to Cinelli

Material: Stainless steel

Other Sizes:

002-0317-11	11.5 cm
002-0317-14	14 cm

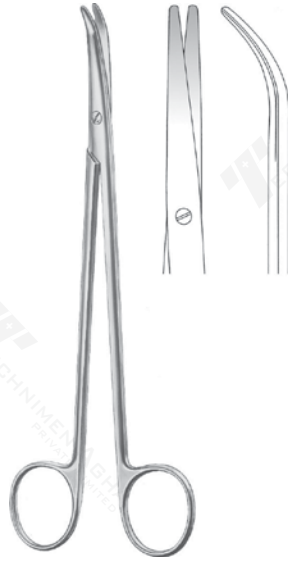

Scissors

Dissecting scissors, acc. to Thorek, curved

Material: Stainless steel

Other Sizes:

002-0319-19	18.5 cm
-------------	---------



Scissors

Dissecting scissors, acc. to Lexer-Baby, straight

Material: Stainless steel

Other Sizes:

002-0320-10	10 cm
-------------	-------



Scissors

Dissecting scissors, acc. to Lexer-Baby, curved

Material: Stainless steel

Other Sizes:

002-0321-10	10 cm
-------------	-------

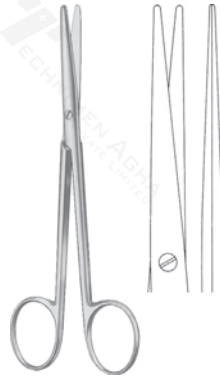

Scissors

Scissors, acc. to Lexer, fine, straight

Material: Stainless steel

Other Sizes:

002-0324-16	16.5 cm
-------------	---------

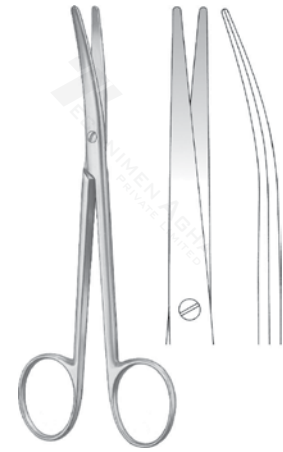

Scissors

Scissors, acc. to Lexer, fine, curved

Material: Stainless steel

Other Sizes:

002-0325-16	16.5 cm
-------------	---------

SCISSORS

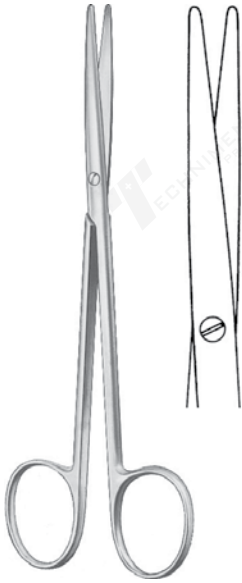

Scissors

Dissecting scissors, fine, straight

Material: Stainless steel

Other Sizes:

002-0326-14 : 14.5 cm

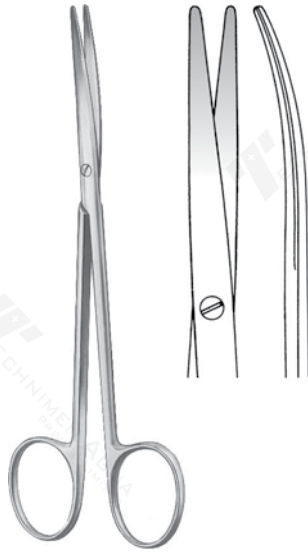

Scissors

Dissecting scissors, fine, curved

Material: Stainless steel

Other Sizes:

002-0327-14 : 14.5 cm



Scissors

Scissors, fine, pointed/pointed, straight

Material: Stainless steel

Other Sizes:

002-0328-14 : 14.5 cm



Scissors

Scissors, fine, pointed/pointed, curved

Material: Stainless steel

Other Sizes:

002-0329-14 : 14.5 cm



Scissors

Dissecting scissors, fine, straight

Material: Stainless steel

Other Sizes:

002-0330-18 : 18 cm
002-0330-20 : 20 cm
002-0330-23 : 23 cm



Scissors

Dissecting scissors, fine, curved

Material: Stainless steel

Other Sizes:

002-0331-18 : 18 cm
002-0331-20 : 20 cm
002-0331-23 : 23 cm

SCISSORS

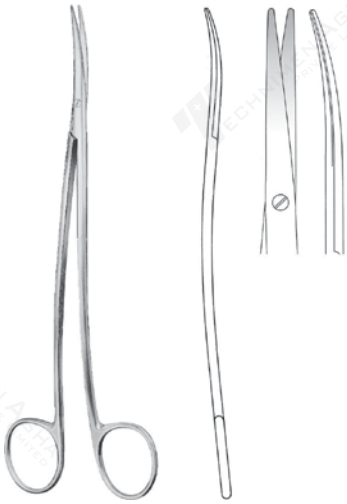

Scissors

Dissecting scissors, fine, s-shape

Material: Stainless steel

Other Sizes:

002-0335-18	18 cm
002-0335-20	20 cm
002-0335-23	23 cm

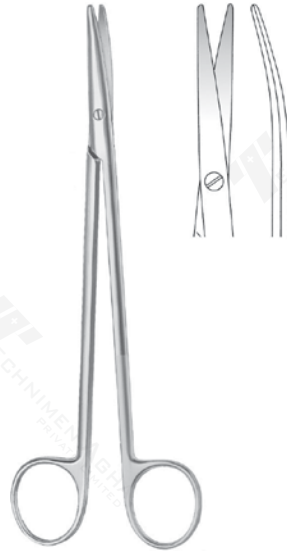

Scissors

Cleft palate scissors, curved

Material: Stainless steel

Other Sizes:

002-0339-12	12.5 cm
002-0339-18	18 cm

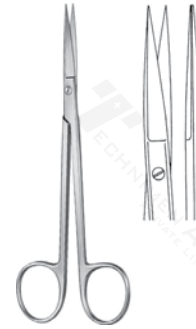

Scissors

Scissors, acc. to Sanvenero, pointed/pointed, straight

Material: Stainless steel

Other Sizes:

002-0340-14	14 cm
-------------	-------

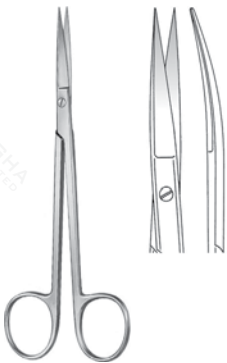

Scissors

Scissors, acc. to Sanvenero pointed/pointed, curved

Material: Stainless steel

Other Sizes:

002-0341-14	14 cm
-------------	-------

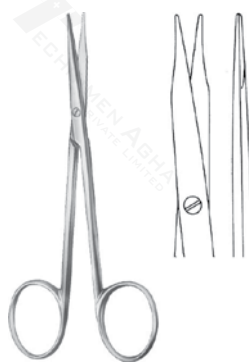

Scissors

Dissecting scissors, fine, straight

Material: Stainless steel

Other Sizes:

002-0344-11	11.5 cm
-------------	---------

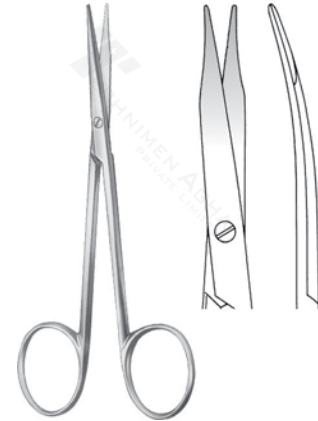

Scissors

Dissecting scissors, fine, curved

Material: Stainless steel

Other Sizes:

002-0345-11	11.5 cm
-------------	---------

SCISSORS

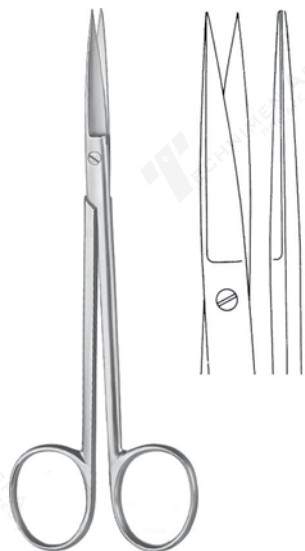

Scissors

Scissors, acc. to Joseph, pointed/pointed, straight

Material: Stainless steel

Other Sizes:

002-0350-14 : 14.5 cm

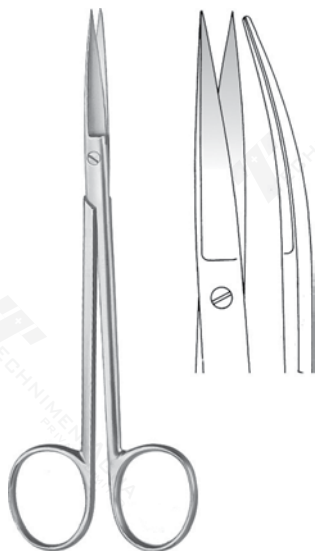

Scissors

Scissors, acc. to Joseph, pointed/pointed, curved

Material: Stainless steel

Other Sizes:

002-0351-14 : 14.5 cm

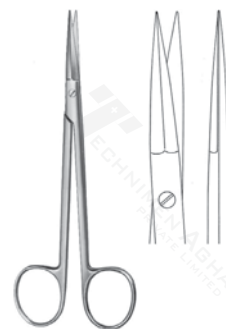

Scissors

Scissors, acc. to Peck-Joseph, straight, SH

Material: Stainless steel

Other Sizes:

002-0352-14 : 14.5 cm

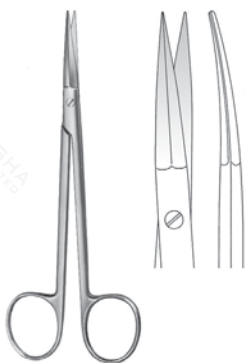

Scissors

Scissors, acc. to Peck-Joseph, curved, SH

Material: Stainless steel

Other Sizes:

002-0353-14 : 14.5 cm

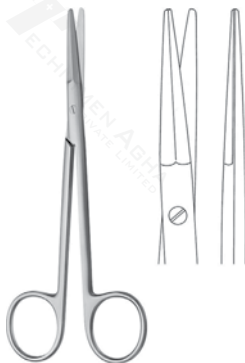

Scissors

Scissors, acc. to Peck-Joseph, straight, BL

Material: Stainless steel

Other Sizes:

002-0354-14 : 14.5 cm

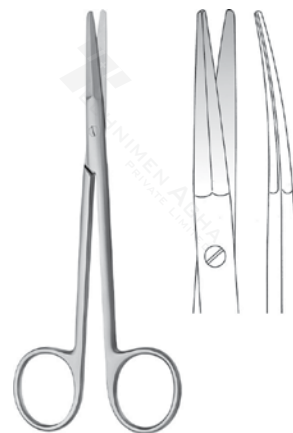

Scissors

Scissors, acc. to Peck-Joseph, curved, BL

Material: Stainless steel

Other Sizes:

002-0355-14 : 14.5 cm

SCISSORS

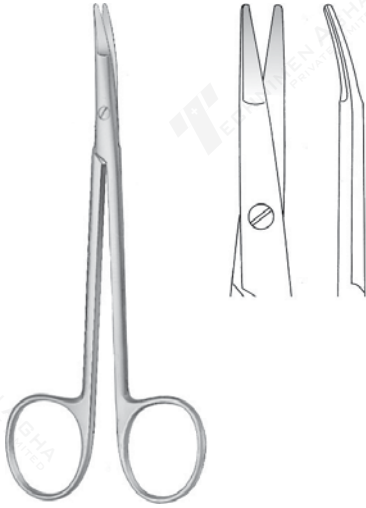

Scissors

Vein scissors, acc. to Shea, curved

Material: Stainless steel

Other Sizes:

002-0357-12 12 cm

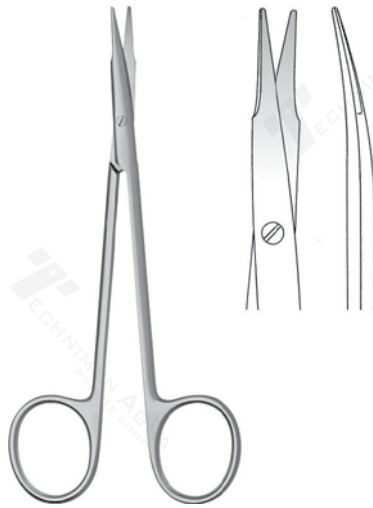

Scissors

Dissecting and gum scissors

Material: Stainless steel

Other Sizes:

002-0358-13 13 cm



Scissors

Dissecting scissors, acc. to acc. to Kilner, curved

Material: Stainless steel

Other Sizes:

002-0359-12 12 cm
002-0359-15 15 cm

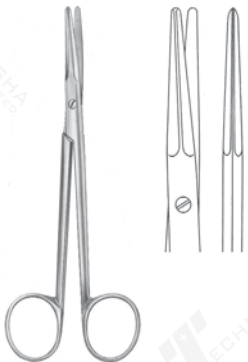

Scissors

Dissecting scissors, straight

Material: Stainless steel

Other Sizes:

002-0362-14 14.5 cm

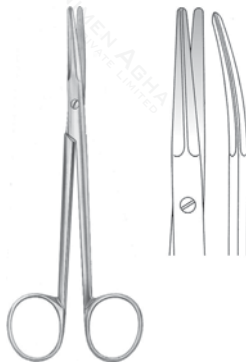

Scissors

Dissecting scissors, curved

Material: Stainless steel

Other Sizes:

002-0363-14 14.5 cm

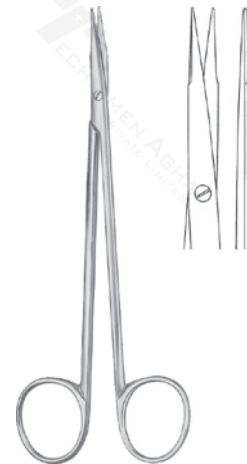

Scissors

Scissors, acc. to Reynolds, straight

Material: Stainless steel

Other Sizes:

002-0364-15 15.5 cm

SCISSORS

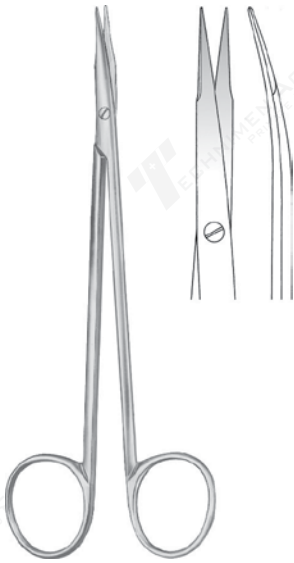

Scissors

Scissors, acc. to Reynolds, curved

Material: Stainless steel

Other Sizes:

002-0365-15	15.5 cm
002-0365-18	18 cm

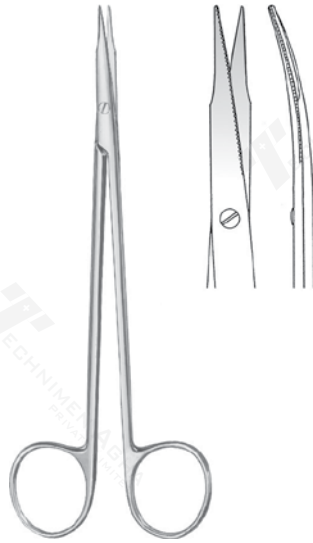

Scissors

Scissors, acc. to Jameson, curved, serrated

Material: Stainless steel

Other Sizes:

002-0369-14	15.5 cm
-------------	---------



Scissors

Micro scissors, straight, pointed/pointed

Material: Stainless steel

Other Sizes:

002-0370-01	12cm
-------------	------



Scissors

Micro scissors, curved, pointed/pointed

Material: Stainless steel

Other Sizes:

002-0371-01	12 cm
002-0371-02	12 cm

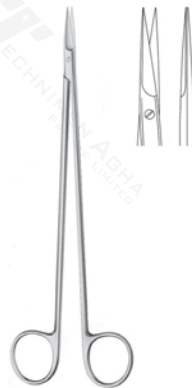

Scissors

Vascular scissors, fine, pointed/pointed, straight

Material: Stainless steel

Other Sizes:

002-0374-19	19 cm
-------------	-------

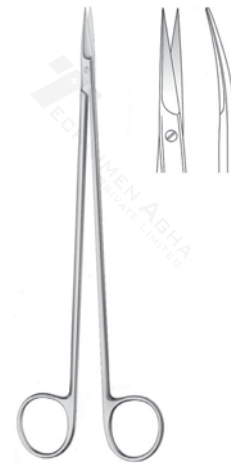

Scissors

Vascular scissors, fine, pointed/pointed, curved

Material: Stainless steel

Other Sizes:

002-0375-19	19 cm
002-0375-24	25.5 cm

SCISSORS



Scissors

Scissors, acc. to DiethriCh Salyer, angled

Material: Stainless steel

Other Sizes:

002-0379-45 : 12 cm



Scissors

Vascular scissors, acc. to DiethriCh, 25°

Material: Stainless steel

Other Sizes:

002-0380-25 : 19 cm



Scissors

Vascular scissors, acc. to DiethriCh, 45°

Material: Stainless steel

Other Sizes:

002-0380-45 : 18.5 cm



Scissors

Vascular scissors, acc. to DiethriCh, 60°

Material: Stainless steel

Other Sizes:

002-0380-60 : 18.5 cm



Scissors

Vascular scissors, acc. to DiethriCh, 90°

Material: Stainless steel

Other Sizes:

002-0380-90 : 17.5 cm



Scissors

Vascular scissors, acc. to DiethriCh, 125°, with guide

Material: Stainless steel

Other Sizes:

002-0381-01 : 17.5 cm

SCISSORS



Scissors

Coronary scissors, 25°

Material: Stainless steel

Other Sizes:

002-0382-25 : 7 mm, 18.5 cm



Scissors

Coronary scissors, 45°

Material: Stainless steel

Other Sizes:

002-0382-45 : 7 mm, 18.5 cm



Scissors

Coronary scissors, 60°

Material: Stainless steel

Other Sizes:

002-0382-60 : 7 mm, 18.5 cm



Scissors

Coronary scissors, 90°

Material: Stainless steel

Other Sizes:

002-0382-90 : 7 mm, 18.5 cm



Scissors

Coronary scissors, 125°

Material: Stainless steel

Other Sizes:

002-0383-01 : 7 mm, 18.5 cm



Scissors

Coronary scissors, 125°

Material: Stainless steel

Other Sizes:

002-0383-01 : 7 mm, 18.5 cm

SCISSORS



Scissors

Vascular scissors, 60°

Material: Stainless steel

Other Sizes:

002-0390-60 : 16 cm



Scissors

Scissors, angled 60°, button-end

Material: Stainless steel

Other Sizes:

002-0391-19 : 18 cm



Scissors

Scissors, angled 60°

Material: Stainless steel

Other Sizes:

002-0393-19 : 18 cm



Scissors

Scissors, angled 40°

Material: Stainless steel

Other Sizes:

002-0394-19 : 18.5 cm



Scissors

Scissors, angled 25°

Material: Stainless steel

Other Sizes:

002-0395-19 : 19 cm



Scissors

TC scissors, acc. to acc. to Potts-Smith

Material: Stainless steel

Other Sizes:

002-0396-19 : 18 cm

SCISSORS



Scissors

Scissors, acc. to acc. to Potts, angled upwards

Material: Stainless steel

Other Sizes:

002-0397-19 18.5 cm



Scissors

TC-scissors, acc. to acc. to Potts-Smith

Material: Stainless steel

Other Sizes:

002-0398-19 18.5 cm



Scissors

TC-scissors, acc. to acc. to Potts-Smith

Material: Stainless steel

Other Sizes:

002-0399-19 19 cm



Scissors

Coronary scissors, 25°, 10 mm

Material: Stainless steel

Other Sizes:

002-0400-25 18 cm
 002-0408-25 18 cm
 002-0384-25 21 cm
 002-0398-25 23 cm



Scissors

Coronary scissors, 45°, 10 mm

Material: Stainless steel

Other Sizes:

002-0400-45 18 cm
 002-0408-45 18 cm
 002-0384-45 21 cm
 002-0398-45 23 cm



Scissors

Coronary scissors, 60°, 10 mm

Material: Stainless steel

Other Sizes:

002-0400-60 18 cm
 002-0408-60 18 cm
 002-0384-60 21 cm
 002-0398-60 23 cm

SCISSORS



Scissors

Coronary scissors, 90°, 10 mm

Material: Stainless steel

Other Sizes:

002-0400-90	18 cm
002-0408-90	18 cm
002-0384-90	21 cm
002-0398-90	23 cm



Scissors

Coronary scissors, 125°, 10 mm

Material: Stainless steel

Other Sizes:

002-0401-00	18 cm
002-0409-00	18 cm
002-0385-00	21 cm
002-0399-00	23 cm



Scissors

Coronary scissors, 25°

Material: Stainless steel

Other Sizes:

002-0402-25	7 mm, 18 cm
002-0410-25	7 mm, 18 cm



Scissors

Coronary scissors, 45°

Material: Stainless steel

Other Sizes:

002-0402-45	7 mm, 18 cm
002-0410-45	7 mm, 18 cm



Scissors

Coronary scissors, 60°

Material: Stainless steel

Other Sizes:

002-0402-60	7 mm, 18 cm
002-0410-60	7 mm, 18 cm



Scissors

Coronary scissors, 90°

Material: Stainless steel

Other Sizes:

002-0402-90	7 mm, 18 cm
002-0410-90	7 mm, 18 cm

SCISSORS



Scissors

Coronary scissors, 125°

Material: Stainless steel

Other Sizes:

- 002-0403-00 : 7 mm, 18 cm
- 002-0411-00 : 7 mm, 18 cm



Scissors

Coronary scissors, 25°, 10 mm, round Handle

Material: Stainless steel

Other Sizes:

- 002-0412-25 : 18 cm
- 002-0436-25 : 21 cm
- 002-0438-25 : 23 cm



Scissors

Coronary scissors, 45°, 10 mm, round Handle

Material: Stainless steel

Other Sizes:

- 002-0412-45 : 18 cm
- 002-0436-45 : 21 cm
- 002-0438-45 : 23 cm



Scissors

Coronary scissors, 60°, 10 mm, round Handle

Material: Stainless steel

Other Sizes:

- 002-0412-60 : 18 cm
- 002-0436-60 : 21 cm
- 002-0438-60 : 23 cm



Scissors

Coronary scissors, 90°, 10 mm, round Handle

Material: Stainless steel

Other Sizes:

- 002-0412-90 : 18 cm



Scissors

Coronary scissors, 125°, 10 mm, round Handle

Material: Stainless steel

Other Sizes:

- 002-0413-00 : 18 cm
- 002-0437-00 : 21 cm
- 002-0439-00 : 23 cm

SCISSORS



Scissors

Coronary scissors, 25°, 7 mm, round Handle

Material: Stainless steel

Other Sizes:

002-0414-25 18 cm



Scissors

Coronary scissors, 45°, 7 mm, round Handle

Material: Stainless steel

Other Sizes:

002-0414-45 18 cm



Scissors

Coronary scissors, 60°, 7 mm round Handle

Material: Stainless steel

Other Sizes:

002-0414-60 18 cm



Scissors

Coronary scissors, 90°, 7 mm round Handle

Material: Stainless steel

Other Sizes:

002-0414-90 18 cm



Scissors

Coronary scissors, 125°, 7 mm round Handle

Material: Stainless steel

Other Sizes:

002-0415-00 18 cm



Scissors

TC coronary scissors, 25°, 10mm round Handle

Material: Stainless steel

Other Sizes:

002-0416-25 18 cm

SCISSORS



Scissors

TC coronary scissors, 45°, 10mm, round Handle

Material: Stainless steel

Other Sizes:

002-0416-45 : 18 cm



Scissors

TC coronary scissors, 60°, 10mm, round Handle

Material: Stainless steel

Other Sizes:

002-0416-60 : 18 cm



Scissors

TC coronary scissors, 90°, 10mm, round Handle

Material: Stainless steel

Other Sizes:

002-0416-90 : 18 cm



Scissors

TC coronary scissors, 125°, 10mm, round Handle

Material: Stainless steel

Other Sizes:

002-0417-00 : 18 cm



Scissors

TC coronary scissors, 25°, 10mm, flat Handle

Material: Stainless steel

Other Sizes:

002-0418-25 : 18 cm



Scissors

TC coronary scissors, 45°, 10mm, flat Handle

Material: Stainless steel

Other Sizes:

002-0418-45 : 18 cm

SCISSORS



Scissors

TC coronary scissors, 60°, 10mm,
flat Handle

Material: Stainless steel

Other Sizes:

002-0418-60 : 18 cm



Scissors

TC coronary scissors, 90°, 10mm,
flat Handle

Material: Stainless steel

Other Sizes:

002-0418-90 : 18 cm



Scissors

TC coronary scissors, 125°, 10mm,
flat Handle

Material: Stainless steel

Other Sizes:

002-0419-00 : 18 cm



Scissors

Vascular scissors, acc.
to Favaloro

Material: Stainless steel

Other Sizes:

002-0419-19 : 15 cm



Scissors

Vascular scissors, button,
straight

Material: Stainless steel

Other Sizes:

002-0420-11 : 12 cm



Scissors

Vascular scissors, curved

Material: Stainless steel

Other Sizes:

002-0421-14 : 14 cm

SCISSORS



Scissors

Vascular scissors, with probe, straight

Material: Stainless steel

Other Sizes:
002-0422-15 : 14.5 cm



Scissors

Scissors, acc. to Favaloro, 125°, 10 mm

Material: Stainless steel

Other Sizes:
002-0435-01 : 18 cm
002-0435-02 : 18 cm



Scissors

Scissors, acc. to Strully, blunt/blunt, curved

Material: Stainless steel

Other Sizes:
002-0445-22 : 22.5 cm



Scissors

Scissors, acc. to Strully, pointed/pointed, curved

Material: Stainless steel

Other Sizes:
002-0446-22 : 22 cm



Scissors

Dura scissors, acc. to Schmiden-acc. to Taylor

Material: Stainless steel

Other Sizes:
002-0455-17 : 16.5 cm



Scissors

Scissors, acc. to Toennis-Adson, curved

Material: Stainless steel

Other Sizes:
002-0459-17 : 17.5 cm

SCISSORS



Scissors

Scissors, acc. to Toennis, straight

Material: Stainless steel

Other Sizes:

002-0461-18 18 cm



Scissors

Scissors, acc. to Toennis, curved

Material: Stainless steel

Other Sizes:

002-0462-18 18 cm



Scissors

Scissors, acc. to Olivecrona, knee-bent

Material: Stainless steel

Other Sizes:

002-0475-23 23 cm

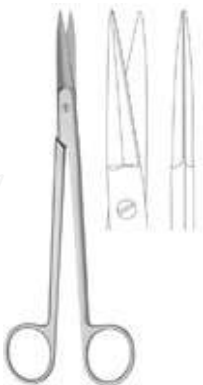

Scissors

Cartilage scissors, acc to McIndoe

Material: Stainless steel

Other Sizes:

002-0480-19 18.5 cm



Scissors

Scissors, acc. to Dean, angled upwards

Material: Stainless steel

Other Sizes:

002-0495-17 17.5 cm

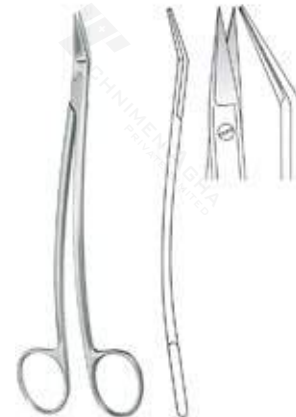

Scissors

Scissors, acc. to Dean, serrated, angled upwards

Material: Stainless steel

Other Sizes:

002-0497-17 17.5 cm

SCISSORS



Scissors

Tonsil scissors, acc. to Good, curved

Material: Stainless steel

Other Sizes:

002-0499-19 19.5 cm



Scissors

TC nasal scissors, acc. to Fomon, curved

Material: Stainless steel

Other Sizes:

002-0503-15 14.5 cm



Scissors

Nasal scissors, acc. to Fomon, knee-bent

Material: Stainless steel

Other Sizes:

002-0507-15 15 cm



Scissors

Nasal scissors, acc. to Cottle

Material: Stainless steel

Other Sizes:

002-0509-16 16 cm



Scissors

Nasal scissors, acc. to Heymann

Material: Stainless steel

Other Sizes:

002-0511-18 18.5 cm



Scissors

Nasal scissors, acc. to Heymann, serrated

Material: Stainless steel

Other Sizes:

002-0513-18 18.5 cm

SCISSORS



Scissors

Scissors, acc. to Converse, blunt/blunt

Material: Stainless steel

Other Sizes:

002-0517-11 : 10.5 cm



Scissors

Scissors, acc. to Converse, pointed/pointed

Material: Stainless steel

Other Sizes:

002-0519-11 : 10.5 cm



Scissors

Episiotomy scissors, acc. Waldmann

Material: Stainless steel

Other Sizes:

002-0531-18 : 18 cm



Scissors

Perineum scissors, acc. to acc. to Braun-Stadler

Material: Stainless steel

Other Sizes:

002-0535-14 : 14.5 cm



Scissors

Perineum scissors, acc. to acc. to Braun-Stadler

Material: Stainless steel

Other Sizes:

002-0537-22 : 22 cm



Scissors

Umbilical scissors, US-type

Material: Stainless steel

Other Sizes:

002-0545-10 : 10.5 cm

SCISSORS



Scissors

Umbilical scissors, acc. to SchuhmaCher

Material: Stainless steel

Other Sizes:

002-0547-16 : 16 cm



Scissors

Umbilical scissors, acc. to BusCh

Material: Stainless steel

Other Sizes:

002-0551-16 : 16 cm



Scissors

Umbilical scissors, acc. to BusCh, serrated

Material: Stainless steel

Other Sizes:

002-0553-16 : 16 cm



Scissors

Scissors, acc. to Goldmann-acc. to Fox, straight, serrated

Material: Stainless steel

Other Sizes:

002-0566-13 : 13 cm



Scissors

Scissors, acc. to Goldmann-acc. to Fox, curved, serrated

Material: Stainless steel

Other Sizes:

002-0567-13 : 13 cm



Scissors

Scissors, acc. to Wagner, pointed/pointed, straight

Material: Stainless steel

Other Sizes:

002-0570-12 : 12 cm

SCISSORS



Scissors

Scissors, acc.to Wagner,
pointed/pointed, curved

Material: Stainless steel

Other Sizes:

002-0571-12 : 12 cm



Scissors

Scissors, delicate, blunt/blunt, straight

Material: Stainless steel

Other Sizes:

002-0580-12 : 12 cm



Scissors

Scissors, delicate, pointed/blunt, straight

Material: Stainless steel

Other Sizes:

002-0582-12 : 12 cm



Scissors

Scissors, delicate, pointed/pointed,
straight

Material: Stainless steel

Other Sizes:

002-0584-12 : 12 cm



Scissors

Scissors, delicate, blunt/blunt, curved

Material: Stainless steel

Other Sizes:

002-0585-12 : 12 cm



Scissors

Scissors, delicate, pointed/blunt, curved

Material: Stainless steel

Other Sizes:

002-0587-12 : 12 cm

SCISSORS



Scissors

Scissors, delicate, pointed/pointed, curved

Material: Stainless steel

Other Sizes:

002-0589-12 : 12 cm



Scissors

Gum scissors, s-shape

Material: Stainless steel

Other Sizes:

002-0593-11 : 11.5 cm



Scissors

Scissors, delicate, blunt/blunt, straight

Material: Stainless steel

Other Sizes:

002-0594-11 : 11.5 cm



Scissors

Scissors, delicate, blunt/blunt, curved

Material: Stainless steel

Other Sizes:

002-0595-11 : 11.5 cm

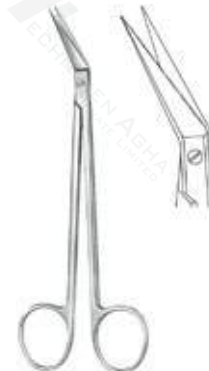

Scissors

Scissors, acc.to Locklin, angled, serrated

Material: Stainless steel

Other Sizes:

002-0605-16 : 16 cm



Scissors

Scissors, acc.to Locklin,, curved, serrated

Material: Stainless steel

Other Sizes:

002-0607-16 : 16 cm

SCISSORS



Scissors

Scissors, delicate, pointed/pointed, straight

Material: Stainless steel

Other Sizes:

002-0618-08 : 9 cm



Scissors

Scissors, delicate, pointed/pointed, curved

Material: Stainless steel

Other Sizes:

002-0619-08 : 9 cm



Scissors

Iris scissors, pointed/pointed, straight

Material: Stainless steel

Other Sizes:

002-0620-09 : 9 cm
002-0620-10 : 10 cm



Scissors

Iris scissors, pointed/pointed, curved

Material: Stainless steel

Other Sizes:

002-0621-09 : 9 cm
002-0621-10 : 10 cm



Scissors

Iris scissors, pointed/pointed, extra flat blades, straight

Material: Stainless steel

Other Sizes:

002-0622-10 : 10 cm



Scissors

Iris scissors, acc. to Bonn, blunt/blunt, straight

Material: Stainless steel

Other Sizes:

002-0624-09 : 9 cm

SCISSORS



Scissors

Iris scissors, acc. to Bonn, blunt/blunt, curved

Material: Stainless steel

Other Sizes:

002-0625-09 : 9 cm



Scissors

Iris scissors, pointed/pointed, straight

Material: Stainless steel

Other Sizes:

002-0630-11 : 11.5 cm



Scissors

Iris scissors, pointed/pointed, curved

Material: Stainless steel

Other Sizes:

002-0631-11 : 11.5 cm



Scissors

Iris scissors, pointed/pointed, curved down

Material: Stainless steel

Other Sizes:

002-0633-11 : 11.5 cm



Scissors

Iris scissors, pointed/pointed, angled

Material: Stainless steel

Other Sizes:

002-0635-11 : 11.5 cm



Scissors

Scissors, acc. to Graefe

Material: Stainless steel

Other Sizes:

002-0637-10 : 10 cm

SCISSORS



Scissors

Iris scissors, pointed/pointed, straight

Material: Stainless steel

Other Sizes:

002-0640-12 : 12.5 cm



Scissors

Iris scissors, pointed/pointed, straight

Material: Stainless steel

Other Sizes:

002-0640-12 : 12.5 cm



Scissors

Iris scissors, pointed/pointed, curved

Material: Stainless steel

Other Sizes:

002-0641-12 : 12.5 cm



Scissors

Teacc. to Notomy scissors, pointed/pointed, straight

Material: Stainless steel

Other Sizes:

002-0680-11 : 11 cm



Scissors

Teacc. to Notomy scissors, pointed/pointed, curved

Material: Stainless steel

Other Sizes:

002-0681-11 : 11 cm



Scissors

Teacc. to Notomy scissors, blunt/blunt, straight

Material: Stainless steel

Other Sizes:

002-0682-11 : 11 cm

SCISSORS



Scissors

Teacc. to Notomy scissors,
blunt/blunt, curved

Material: Stainless steel

Other Sizes:

002-0683-11 11 cm



Scissors

Stabismus scissors,
blunt/blunt, straight

Material: Stainless steel

Other Sizes:

002-0690-11 11.5 cm



Scissors

Stabismus scissors, blunt/blunt, curved

Material: Stainless steel

Other Sizes:

002-0691-11 11.5 cm



Scissors

Micro scissors, pointed/pointed, straight

Material: Stainless steel

Other Sizes:

002-0700-00 9 mm, 15 cm
002-0700-04 14 mm, 15 cm



Scissors

Micro scissors, pointed/pointed, straight

Material: Stainless steel

Other Sizes:

002-0700-01 9 mm, 15 cm
002-0700-05 14 mm, 15 cm



Scissors

Micro scissors, pointed/pointed,
straight, cutting edge length 9 mm

Material: Stainless steel

Other Sizes:

002-0700-02 15 cm

SCISSORS



Scissors

Micro scissors, pointed/pointed, straight, cutting edge length 9 mm

Material: Stainless steel

Other Sizes:
002-0700-03 : 15 cm



Scissors

Micro scissors, pointed/pointed, straight, cutting edge length 14 mm

Material: Stainless steel

Other Sizes:
002-0700-06 : 15 cm



Scissors

Micro scissors, pointed/pointed, straight, cutting edge length 14 mm

Material: Stainless steel

Other Sizes:
002-0700-07 : 15 cm



Scissors

Micro scissors, blunt/blunt, straight

Material: Stainless steel

Other Sizes:
002-0701-00 : 9 mm, 15 cm
002-0701-04 : 14 mm, 15 cm



Scissors

Micro scissors, blunt/blunt, straight

Material: Stainless steel

Other Sizes:
002-0701-01 : 9 mm, 15 cm
002-0701-05 : 14 mm, 15 cm



Scissors

Micro scissors, blunt/blunt, straight, cutting edge length 9 mm

Material: Stainless steel

Other Sizes:
002-0701-02 : 15 cm

SCISSORS



Scissors

Micro scissors, blunt/blunt, straight, cutting edge length 9 mm

Material: Stainless steel

Other Sizes:

002-0701-02 : 15 cm



Scissors

Micro scissors, blunt/blunt, straight, cutting edge length 9 mm

Material: Stainless steel

Other Sizes:

002-0701-03 : 15 cm



Scissors

Micro scissors, blunt/blunt, curved, cutting edge length 14 mm

Material: Stainless steel

Other Sizes:

002-0701-06 : 15 cm



Scissors

Micro scissors, blunt/blunt, curved, cutting edge length 14 mm

Material: Stainless steel

Other Sizes:

002-0701-07 : 15 cm



Scissors

Enucleation scissors, curved

Material: Stainless steel

Other Sizes:

002-0705-11 : 11.5 cm



Scissors

Micro scissors, pointed/pointed, straight, 10 mm

Material: Stainless steel

Other Sizes:

002-0710-15 : 15 cm
002-0710-18 : 18 cm
002-0710-21 : 21 cm
002-0710-23 : 23 cm
002-0716-15 : 15 cm
002-0716-18 : 18 cm
002-0716-21 : 21 cm

SCISSORS



Scissors

Micro scissors, pointed/pointed, straight, 10 mm

Material: Stainless steel

Other Sizes:

002-0710-19 : 18 cm



Scissors

Micro scissors, pointed/pointed, curved, 10 mm

Material: Stainless steel

Other Sizes:

002-0711-15 : 15 cm
 002-0711-18 : 18 cm
 002-0711-21 : 21 cm
 002-0711-23 : 23 cm
 002-0717-15 : 15 cm
 002-0717-18 : 18 cm
 002-0717-21 : 21 cm



Scissors

Micro scissors, blunt/blunt, curved, 10 mm

Material: Stainless steel

Other Sizes:

002-0711-19 : 18 cm



Scissors

Micro scissors, pointed/pointed, straight, 10 mm

Material: Stainless steel

Other Sizes:

002-0712-15 : 15 cm
 002-0712-18 : 18 cm
 002-0712-21 : 21 cm
 002-0712-23 : 23 cm
 002-0718-15 : 15 cm
 002-0718-18 : 18 cm
 002-0718-21 : 21 cm



Scissors

Micro scissors, blunt/blunt, curved, 10 mm

Material: Stainless steel

Other Sizes:

002-0711-20 : 18 cm



Scissors

Micro scissors, pointed/pointed, straight, 10 mm

Material: Stainless steel

Other Sizes:

002-0712-19 : 18 cm

SCISSORS



Scissors

Micro scissors, pointed/pointed, curved, 10 mm

Material: Stainless steel

Other Sizes:

002-0713-15	15 cm
002-0713-18	18 cm
002-0713-21	21 cm
002-0713-23	23 cm
002-0719-15	15 cm
002-0719-18	18 cm
002-0719-23	23 cm



Scissors

Micro scissors, blunt/blunt, curved, 10 mm

Material: Stainless steel

Other Sizes:

002-0713-19	18 cm
-------------	-------



Scissors

Micro scissors, pointed/pointed, curved, 10 mm

Material: Stainless steel

Other Sizes:

002-0713-20	18 cm
-------------	-------



Scissors

Micro scissors, bayonet-shape straight

Material: Stainless steel

Other Sizes:

002-0732-23	23 cm
-------------	-------



Scissors

Micro scissors, bayonet shape, curved

Material: Stainless steel

Other Sizes:

002-0733-23	23 cm
-------------	-------



Scissors

Micro scissors, bayonet-shape, straight

Material: Stainless steel

Other Sizes:

002-0734-23	23 cm
-------------	-------

SCISSORS



Scissors
Micro scissors, bayonet
shape, curved

Material: Stainless steel

Other Sizes:
002-0735-23 23 cm



Scissors
Stabismus scissors, straight

Material: Stainless steel

Other Sizes:
002-0740-11 11.5 cm



Scissors
Stabismus scissors, curved

Material: Stainless steel

Other Sizes:
002-0741-11 11.5 cm



Scissors
Micro scissors, bayonet
shape, straight

Material: Stainless steel

Other Sizes:
002-0748-19 18.5 cm



Scissors
Micro scissors, bayonet
shape, curved

Material: Stainless steel

Other Sizes:
002-0749-19 18.5 cm



Scissors
Micro scissors, bayonet
shape, straight

Material: Stainless steel

Other Sizes:
002-0750-19 19 cm

SCISSORS



Scissors

Micro scissors, bayonet-shape, curved upwards

Material: Stainless steel

Other Sizes:

002-0751-19 : 19 cm

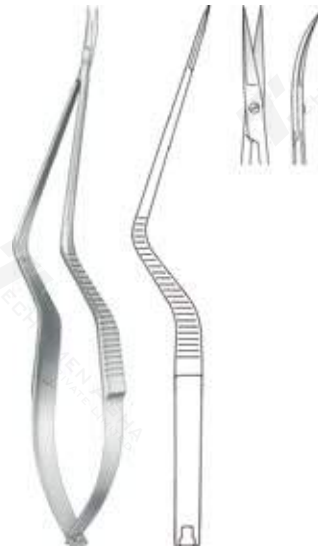

Scissors

Micro scissors, bayonet-shape, curved downwards

Material: Stainless steel

Other Sizes:

002-0752-19 : 19 cm



Scissors

Micro scissors, pointed/pointed, curved

Material: Stainless steel

Other Sizes:

002-0755-11 : 12 cm



Scissors

Micro scissors, pointed/pointed, straight

Material: Stainless steel

Other Sizes:

002-0756-12 : 12 cm



Scissors

Micro vein scissors, acc. to Biemer, straight

Material: Stainless steel

Other Sizes:

002-0758-12 : 12 cm



Scissors

Micro scissors, pointed/pointed, straight

Material: Stainless steel

Other Sizes:

002-0760-09 : 10 cm

SCISSORS



Scissors

Micro scissors, pointed/pointed, angled downwards

Material: Stainless steel

Other Sizes:

002-0761-09 10 cm



Scissors

Scissors, acc. to Jaboma, for cleft palate, left

Material: Stainless steel

Other Sizes:

002-0765-18 18 cm



Scissors

Scissors, acc. to Jaboma, for cleft palate, right

Material: Stainless steel

Other Sizes:

002-0767-18 18 cm



Scissors

Scissors, acc. to Jaboma, for cleft palate, angled

Material: Stainless steel

Other Sizes:

002-0769-18 18 cm



Scissors

N/A

Material: Stainless steel

Other Sizes:

002-0776-01 15.5 cm
002-0776-02 15.5 cm



Scissors

Micro scissors, bayonet-shape, curved

Material: Stainless steel

Other Sizes:

002-0776-02 15.5 cm

SCISSORS



Scissors

Micro scissors, bayonet-shape, straight

Material: Stainless steel

Other Sizes:
002-0778-01 : 15.5 cm



Scissors

Micro scissors, bayonet-shape, curved

Material: Stainless steel

Other Sizes:
002-0778-02 : 15.5 cm



Scissors

Intestinal scissors, with Hook

Material: Stainless steel

Other Sizes:
002-0782-21 : 21.5 cm



Scissors

Clefr palate scissors, straight

Material: Stainless steel

Other Sizes:
002-0784-09 : 9.5 cm

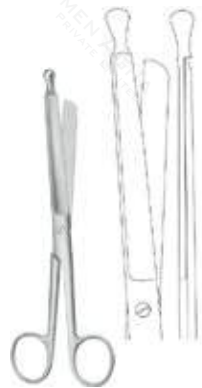

Scissors

Intestinal scissors, button-end

Material: Stainless steel

Other Sizes:
002-0784-21 : 21.5 cm



Scissors

N/A

Material: Stainless steel

Other Sizes:
002-0785-23 : 32.5 cm

SCISSORS



Scissors

Cleft palate scissors, curved

Material: Stainless steel

Other Sizes:

002-0801-10 : 10 cm



Scissors

Face lift scissors, acc. to acc. to Kaye, curved

Material: Stainless steel

Other Sizes:

002-0809-11 : 11 cm



Scissors

StitCh scissors, acc. to Northbent, curved

Material: Stainless steel

Other Sizes:

002-0819-13 : 13 cm



Scissors

Ligature scissors, acc. to Spencer, straight

Material: Stainless steel

Other Sizes:

002-0824-09 : 9 cm



Scissors

Ligature scissors, acc. to Spencer, straight

Material: Stainless steel

Other Sizes:

002-0826-13 : 13 cm



Scissors

Ligature scissors, acc. to Buck, straight

Material: Stainless steel

Other Sizes:

002-0830-14 : 14.5 cm
002-0830-18 : 18 cm

SCISSORS

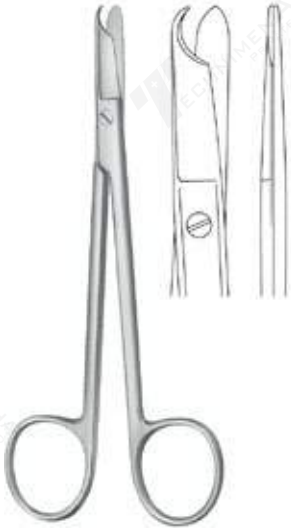

Scissors

Ligature scissors, acc. to Littauer, straight

Material: Stainless steel

Other Sizes:

002-0834-14 : 14 cm



Scissors

Ligature scissors, acc. to Eiselsberg

Material: Stainless steel

Other Sizes:

002-0840-12 : 12 cm



Scissors

Wire scissors, universal-style, angled

Material: Stainless steel

Other Sizes:

002-0865-12 : 12 cm



Scissors

Wire scissors, acc. to Beebee, pointed/pointed, straight

Material: Stainless steel

Other Sizes:

002-0874-10 : 10.5 cm



Scissors

Wire scissors, acc. to Beebee, pointed/pointed, curved

Material: Stainless steel

Other Sizes:

002-0875-10 : 10.5 cm

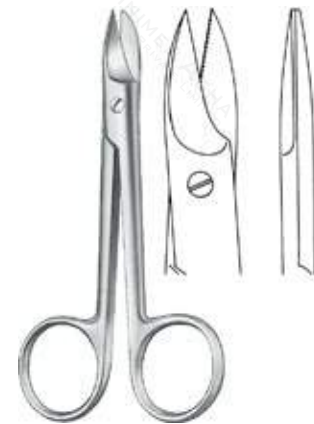

Scissors

Wire scissors, pointed/pointed, straight, serrated

Material: Stainless steel

Other Sizes:

002-0878-12 : 10.5 cm

SCISSORS

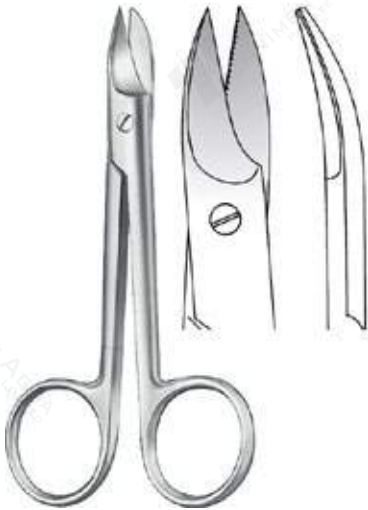

Scissors

Wire scissors, pointed/pointed, curved, serrated

Material: Stainless steel

Other Sizes:

002-0879-12 : 10.5 cm



Scissors

N/A

Material: Stainless steel

Other Sizes:

002-0881-18 : 18 cm
002-0881-20 : 20 cm
002-0881-23 : 23 cm



Scissors

HM scissors, acc. to Lillehei-acc. to Potts, curved

Material: Stainless steel

Other Sizes:

002-0882-18 : 18 cm



Scissors

N/A

Material: Stainless steel

Other Sizes:

002-0883-14 : 14.5 cm
002-0883-18 : 18 cm

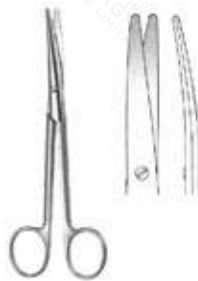

Scissors

N/A

Material: Stainless steel

Other Sizes:

002-0885-16 : 16 cm



Scissors

HM scissors, acc. to acc. to Potts-De Martell

Material: Stainless steel

Other Sizes:

002-0886-20 : 20°, 18 cm
002-0886-50 : 50°, 18 cm
002-0886-90 : 90°, 18 cm

SCISSORS



Scissors

Aquila scissors, curved, extra fine

Material: Stainless steel

Other Sizes:

002-0893-17 : 17.5 cm

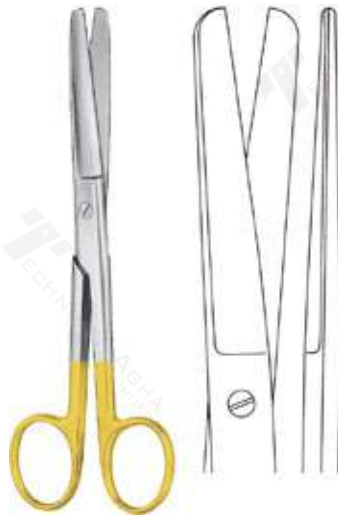

Scissors

TC scissors, blunt/blunt, straight

Material: Stainless steel

Other Sizes:

002-0902-14 : 14.5 cm



Scissors

TC scissors, blunt/blunt, curved

Material: Stainless steel

Other Sizes:

002-0903-14 : 14.5 cm



Scissors

TC scissors, pointed/blunt, straight

Material: Stainless steel

Other Sizes:

002-0904-14 : 14.5 cm



Scissors

TC scissors, pointed/blunt, curved

Material: Stainless steel

Other Sizes:

002-0905-14 : 14.5 cm



Scissors

TC scissors, pointed/pointed, straight

Material: Stainless steel

Other Sizes:

002-0906-14 : 14.5 cm

SCISSORS



Scissors
TC scissors, pointed/pointed,
curved

Material: Stainless steel

Other Sizes:
002-0907-14 : 14.5 cm



Scissors
TC scissors, acc. to Mayo,
straight

Material: Stainless steel

Other Sizes:
002-0910-14 : 14.5 cm
002-0910-17 : 17 cm
002-0910-23 : 23 cm



Scissors
TC scissors, acc. to Mayo, curved

Material: Stainless steel

Other Sizes:
002-0911-14 : 14.5 cm
002-0911-17 : 17 cm
002-0911-23 : 23 cm



Scissors
TC ligature scissors, curved,
one tooth cutting edge, fine

Material: Stainless steel

Other Sizes:
002-0914-14 : 14.5 cm
002-0914-18 : 18 cm
002-0914-20 : 20.5 cm
002-0914-23 : 23 cm
002-0914-25 : 25 cm
002-0914-11 : 11.5 cm
002-0914-30 : 30 cm



Scissors
TC ligature scissors, curved,
one tooth cutting edge

Material: Stainless steel

Other Sizes:
002-0915-14 : 14.5 cm
002-0915-17 : 17 cm
002-0915-23 : 23 cm



Scissors
TCC Blackline dissecting
scissors, curved

Material: Stainless steel

Other Sizes:
002-0919-14 : 14.5 cm
002-0919-18 : 18 cm

SCISSORS



Scissors

TCC Blackline scissors, fine, curved

Material: Stainless steel

Other Sizes:

002-0921-17 17 cm



Scissors

TCC Blackline hysterectomy scissors, strongly curved

Material: Stainless steel

Other Sizes:

002-0927-22 22 cm
002-0927-23 23 cm



Scissors

TC scissors, acc. to Mayo-Stille, straight

Material: Stainless steel

Other Sizes:

002-0930-15 14.5 cm
002-0930-17 17 cm



Scissors

TC scissors, acc. to Mayo-Stille, curved

Material: Stainless steel

Other Sizes:

002-0931-15 14.5 cm
002-0931-17 17 cm



Scissors

TC dissecting scissors, straight

Material: Stainless steel

Other Sizes:

002-0936-11 11.5 cm



Scissors

TC dissecting scissors, curved

Material: Stainless steel

Other Sizes:

002-0937-11 11.5 cm

SCISSORS



Scissors

TC dissecting scissors, straight

Material: Stainless steel

Other Sizes:

002-0938-14 : 14.5 cm



Scissors

TC dissecting scissors, curved

Material: Stainless steel

Other Sizes:

002-0939-14 : 14.5 cm



Scissors

TC dissecting scissors, straight

Material: Stainless steel

Other Sizes:

002-0942-18 : 18 cm
 002-0942-20 : 20.5 cm
 002-0942-23 : 23 cm
 002-0942-25 : 26 cm
 002-0942-28 : 28.5 cm
 002-0942-30 : 31 cm



Scissors

TC dissecting scissors, curved

Material: Stainless steel

Other Sizes:

002-0943-18 : 18 cm
 002-0943-20 : 20.5 cm
 002-0943-23 : 23 cm
 002-0943-25 : 26 cm
 002-0943-28 : 28.5 cm
 002-0943-30 : 31 cm



Scissors

TC scissors, acc. to Metzenbaum-Thorek

Material: Stainless steel

Other Sizes:

002-0945-20 : 28 cm
 002-0945-23 : 23 cm



Scissors

TC scissors, acc. to Joseph, pointed/pointed, straight

Material: Stainless steel

Other Sizes:

002-0948-14 : 14.5 cm

SCISSORS



Scissors

TC scissors, acc. to Joseph, pointed/pointed, curved

Material: Stainless steel

Other Sizes:
002-0949-14 : 14.5 cm



Scissors

TC scissors, acc. to Lexer, fine, straight

Material: Stainless steel

Other Sizes:
002-0950-16 : 16 cm
002-0950-21 : 21 cm



Scissors

TC scissors, acc. to Lexer, fine, curved

Material: Stainless steel

Other Sizes:
002-0951-16 : 16 cm
002-0951-21 : 21 cm



Scissors

TC scissors, acc. to Mayo-Lexer, curved

Material: Stainless steel

Other Sizes:
002-0953-16 : 16 cm



Scissors

TC dissecting scissors, fine, straight

Material: Stainless steel

Other Sizes:
002-0954-14 : 14.5 cm



Scissors

TC dissecting scissors, fine, curved

Material: Stainless steel

Other Sizes:
002-0955-14 : 14.5 cm

SCISSORS



Scissors

TC dissecting scissors
pointed/pointed, straight

Material: Stainless steel

Other Sizes:

002-0956-14 : 14.5 cm



Scissors

TC dissecting scissors,
pointed/pointed, curved

Material: Stainless steel

Other Sizes:

002-0957-14 : 14.5 cm



Scissors

TC dissecting scissors, fine, straight

Material: Stainless steel

Other Sizes:

002-0960-18 : 18 cm



Scissors

TC dissecting scissors, fine, curved

Material: Stainless steel

Other Sizes:

002-0961-18 : 18 cm
002-0961-20 : 20.5 cm
002-0961-23 : 23 cm
002-0961-25 : 26 cm
002-0961-28 : 28.5



Scissors

TC dissecting scissors,
pointed/pointed, straight

Material: Stainless steel

Other Sizes:

002-0962-18 : 18 cm
002-0962-20 : 20 cm
002-0962-23 : 23 cm



Scissors

TC dissecting scissors, acc.
toacc. to Lahey, curved

Material: Stainless steel

Other Sizes:

002-0965-14 : 14.5 cm
002-0965-17 : 17.5 cm
002-0965-20 : 20.5 cm
002-0965-23 : 23 cm

SCISSORS



Scissors

TC dissecting scissors, acc. to acc. to Lahey, curved

Material: Stainless steel

Other Sizes:

002-0965-14	14.5 cm
002-0965-17	17.5 cm
002-0965-20	20.5 cm
002-0965-23	23 cm



Scissors

TC dissecting scissors, fine, s-shape

Material: Stainless steel

Other Sizes:

002-0967-18	18 cm
002-0967-20	20.5 cm
002-0967-23	23 cm



Scissors

TC face lift scissors, straight, serrated

Material: Stainless steel

Other Sizes:

002-0970-19	20 cm
002-0970-23	23 cm



Scissors

TC face lift scissors, curved, serrated

Material: Stainless steel

Other Sizes:

002-0973-17	17 cm
-------------	-------



Scissors

TC uterine scissors, acc. to acc. to Sims, straight

Material: Stainless steel

Other Sizes:

002-0976-23	23 cm
-------------	-------



Scissors

TC uterine scissors, acc. to acc. to Sims, curved

Material: Stainless steel

Other Sizes:

002-0977-23	23 cm
-------------	-------

SCISSORS



Scissors

TC parametrium scissors,
blunt, curved

Material: Stainless steel

Other Sizes:

002-0979-22 : 22.5 cm



Scissors

TC ligature scissors,
pointed/pointed, straight

Material: Stainless steel

Other Sizes:

002-0980-13 : 13 cm



Scissors

TC ligature scissors,
pointed/pointed, curved

Material: Stainless steel

Other Sizes:

002-0981-13 : 13 cm



Scissors

TC iris scissors, pointed/
pointed, straight

Material: Stainless steel

Other Sizes:

002-0982-11 : 11.5 cm



Scissors

TC iris scissors, pointed/
pointed, curved

Material: Stainless steel

Other Sizes:

002-0983-11 : 11.5 cm



Scissors

TC scissors, acc. to De Bakey, 25°

Material: Stainless steel

Other Sizes:

002-0985-25 : 19 cm

SCISSORS



Scissors

TC scissors, acc. to De Bakey,, 45°

Material: Stainless steel

Other Sizes:

002-0985-45 18.5 cm



Scissors

TC scissors, acc. to De Bakey, 60°

Material: Stainless steel

Other Sizes:

002-0985-60 18 cm



Scissors

TC scissors, acc. to De Bakey, 25°

Material: Stainless steel

Other Sizes:

002-0987-25 23 cm



Scissors

TC scissors, acc. to De Bakey, 45°

Material: Stainless steel

Other Sizes:

002-0987-45 23 cm



Scissors

TC scissors, acc. to De Bakey, 60°

Material: Stainless steel

Other Sizes:

002-0987-60 22 cm



Scissors

TC scissors, pointed/pointed, angled

Material: Stainless steel

Other Sizes:

002-0989-11 11 cm

SCISSORS



Scissors
Aquila parametrium scissors,
blunt, curved

Material: Stainless steel

Other Sizes:	
002-0989-22	22 cm
002-0989-23	23 cm



Scissors
TC scissors, acc. to Ragnell, curved

Material: Stainless steel

Other Sizes:	
002-0991-12	12.5 cm



Scissors
TC scissors, acc. to Kelly,
pointed/pointed, straight

Material: Stainless steel

Other Sizes:	
002-0992-16	16 cm



Scissors
TC scissors, acc. to Kelly,
pointed/pointed, curved

Material: Stainless steel

Other Sizes:	
002-0993-16	16 cm



Scissors
TC scissors, acc. to Dean,
pointed/pointed, curved

Material: Stainless steel

Other Sizes:	
002-0994-17	17.5 cm

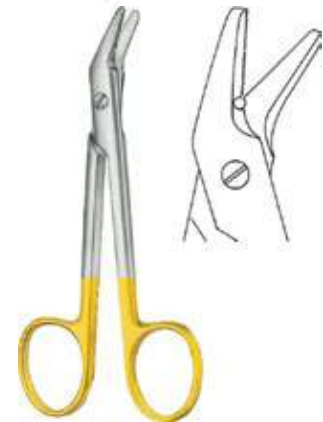

Scissors
TC wire scissors, universal-
style, angled

Material: Stainless steel

Other Sizes:	
002-0995-12	12.5 cm

SCISSORS



Scissors

TC wire scissors, acc. to acc. to Martin

Material: Stainless steel

Other Sizes:

002-0996-16 : 16 cm



Scissors

TC scissors, acc. to Locklin, curved

Material: Stainless steel

Other Sizes:

002-0997-16 : 16 cm



Scissors

TC scissors, acc. to Locklin, curved, serrated

Material: Stainless steel

Other Sizes:

002-0999-16 : 16 cm

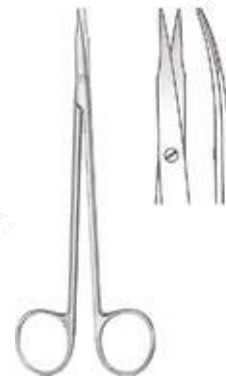

Scissors

Scissors, acc. to Jameson, curved

Material: Stainless steel

Other Sizes:

002-0367-14 : 15.5 cm

SCISSORS

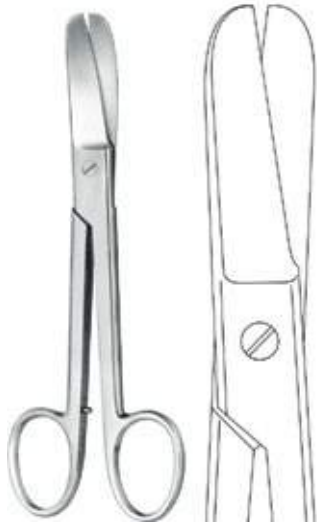

Dressings

Bandage scissors, acc. to Lorenz, curved

Material: Stainless steel

Other Sizes:

012-0155-23 : 23 cm

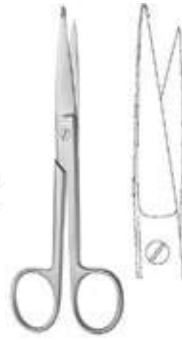

Dressings

Bandage scissors, acc. to Knowles, straight

Material: Stainless steel

Other Sizes:

012-0160-14 : 14 cm



Dressings

Bandage scissors, acc. to Lister

Material: Stainless steel

Other Sizes:

012-0165-14 : 14.5 cm
012-0165-18 : 18.5 cm
012-0165-20 : 20 cm



Dressings

Plaster shears, acc. to Bergmann, angled

Material: Stainless steel

Other Sizes:

012-0195-23 : 23.5 cm



Dressings

Plaster shears, acc. to Esmarch, angled

Material: Stainless steel

Other Sizes:

012-0205-20 : 20 cm



Dressings

Bandage scissors, model "Universal"

Material: steel 18/8 martinit, antimagnetic, stainless, acid-resistant

Other Sizes:

012-0209-15 : 16 cm
012-0209-18 : 19 cm

Available Color: ■ Red ■ Blue ■ Green
■ Gray ■ Black

SCISSORS



Dressings

Plaster shears, acc. to Brun's, serrated

Material: Stainless steel

Other Sizes:

012-0223-24 : 24 cm



Dressings

Plaster shears, acc. to Brun's, smooth

Material: Stainless steel

Other Sizes:

012-0223-26 : 24 cm



Dressings

TC bandage scissors, acc. to Lister

Material: Stainless steel

Other Sizes:

012-0291-18 : 18 cm



Dressings

TC Plaster shears, acc. to Brun's

Material: Stainless steel

Other Sizes:

012-0297-24 : 24 cm

FORCEPS

— RANGE

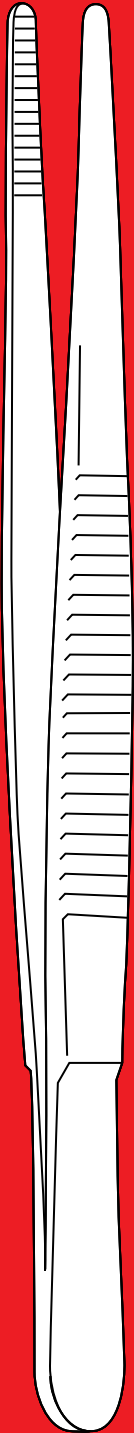

DISCOVER NOW

“Instruments for
surgical procedures”
Since 1970

FORCEPS



Forceps
Dressing forceps

Material: Stainless steel

Other Sizes:

003-0100-10	10.5 cm
003-0100-11	11.5 cm
003-0100-13	13 cm
003-0100-14	14.5 cm
003-0100-16	16 cm
003-0100-18	18 cm
003-0100-20	20 cm
003-0100-23	23 cm
003-0100-25	25 cm
003-0100-30	30.5 cm



Forceps
Dressing forceps, medium wide

Material: Stainless steel

Other Sizes:

003-0120-11	12 cm
003-0120-13	13 cm
003-0120-14	14.5 cm
003-0120-16	16 cm
003-0120-20	20 cm
003-0120-25	25 cm
003-0120-30	30 cm
003-0120-18	18 cm
003-0120-23	23 cm



Forceps
Dressing forceps, medium wide, curved

Material: Stainless steel

Other Sizes:

003-0122-13	13 cm
-------------	-------



Forceps
Dressing forceps, extra wide

Material: Stainless steel

Other Sizes:

003-0123-15	14.5 cm
-------------	---------



Forceps
Dressing forceps, delicate

Material: Stainless steel

Other Sizes:

003-0126-13	13 cm
003-0126-14	14.5 cm



Forceps
Dressing forceps, acc. to Stile

Material: Stainless steel

Other Sizes:

003-0130-15	15 cm
-------------	-------

FORCEPS



Forceps

Dressing forceps, acc. to Bonney

Material: Stainless steel

Other Sizes:

003-0131-17 : 17 cm



Forceps

Dressing forceps, smooth

Material: Stainless steel

Other Sizes:

003-0132-19 : 18.5 cm



Forceps

Dressing forceps, acc. to Brophy, curved

Material: Stainless steel

Other Sizes:

003-0133-20 : 20 cm



Forceps

Dressing forceps, angled down

Material: Stainless steel

Other Sizes:

003-0134-20 : 20 cm



Forceps

Dressing forceps, Swedish type

Material: Stainless steel

Other Sizes:

003-0135-13 : 13 cm
003-0135-15 : 15 cm
003-0135-17 : 17 cm
003-0135-20 : 20 cm



Forceps

Dressing forceps, acc. to Mini-acc. to Adson

Material: Stainless steel

Other Sizes:

003-0166-12 : 12 cm

FORCEPS



Forceps

Dressing forceps, acc. to Adson

Material: Stainless steel

Other Sizes:

- 003-0168-12 : 12 cm
- 003-0168-15 : 15 cm



Forceps

Dressing forceps, acc. to McIndoe

Material: Stainless steel

Other Sizes:

- 003-0170-15 : 15 cm



Forceps

Dressing forceps, acc. to Waugh

Material: Stainless steel

Other Sizes:

- 003-0171-20 : 20 cm



Forceps

Dressing forceps, acc. to Semken

Material: Stainless steel

Other Sizes:

- 003-0172-12 : 12.5 cm
- 003-0172-15 : 15 cm



Forceps

Dressing forceps, acc. to Taylor

Material: Stainless steel

Other Sizes:

- 003-0174-17 : 17 cm



Forceps

Dressing forceps, with scraper

Material: Stainless steel

Other Sizes:

- 003-0180-17 : 17 cm

FORCEPS



Forceps
Dressing forceps, bayonet-shape

Material: Stainless steel

Other Sizes:
003-0183-17 : 18.5 cm



Forceps
Micro dressing forceps, 0.6 mm

Material: Stainless steel

Other Sizes:
003-0184-06 : 15.5 cm
003-0184-08 : 15.5 cm
003-0184-10 : 15.5 cm



Forceps
Atraumatic forceps, straight

Material: Stainless steel

Other Sizes:
003-0184-18 : 17.5 cm



Forceps
Dressing forceps, acc. to Gerald, straight

Material: Stainless steel

Other Sizes:
003-0186-18 : 17.5 cm



Forceps
Dressing forceps, acc. to Gerald, curved

Material: Stainless steel

Other Sizes:
003-0187-18 : 17.5 cm



Forceps
Dressing forceps, acc. to Cushing straight

Material: Stainless steel

Other Sizes:
003-0188-17 : 17.5 cm

FORCEPS



Forceps
Dressing forceps, acc. to Cushing curved

Material: Stainless steel

Other Sizes:
003-0189-17 : 17.5 cm



Forceps
Dressing forceps, acc. to acc. to Potts-Smith

Material: Stainless steel

Other Sizes:
003-0192-18 : 18 cm
003-0192-21 : 21 cm
003-0192-25 : 24.5 cm
003-0192-30 : 30 cm



Forceps
TC forceps, acc. to Booney, 1 x 2 teeth

Material: Stainless steel

Other Sizes:
003-0230-17 : 17.5 cm



Forceps
TC forceps, acc. Gerald, 1 x 2 teeth

Material: Stainless steel

Other Sizes:
003-0234-17 : 17.5 cm



Forceps
TC forceps, acc. acc. to Gillies, 1 x 2 teeth

Material: Stainless steel

Other Sizes:
003-0236-15 : 15.5 cm



Forceps
TC dressing forceps, acc. to McIndoe

Material: Stainless steel

Other Sizes:
003-0238-15 : 15 cm

FORCEPS



Forceps
TC forceps, acc. to Semken, 1 x 2 teeth

Material: Stainless steel

Other Sizes:
003-0240-16 15.5 cm
003-0240-18 17.5 cm



Forceps
TC forceps, 1 x 2 teeth, delicate

Material: Stainless steel

Other Sizes:
003-0242-16 15.5 cm
003-0242-18 17.5 cm



Forceps
TC forceps, acc. to Adson-Brown, serrated

Material: Stainless steel

Other Sizes:
003-0244-12 12 cm



Forceps
TC forceps, acc. to Micro-acc. to Adson, 1 x 2 teeth

Material: Stainless steel

Other Sizes:
003-0246-12 12 cm
003-0246-15 15 cm



Forceps
TC dressing forceps, acc. to Adson

Material: Stainless steel

Other Sizes:
003-0250-12 12 cm
003-0250-15 15 cm



Forceps
TC dressing forceps, acc. to Cushing

Material: Stainless steel

Other Sizes:
003-0254-17 17.5 cm

FORCEPS



Forceps
TC dressing forceps, acc. to Cushing

Material: Stainless steel

Other Sizes:
003-0254-17 : 17.5 cm



Forceps
TC dressing forceps, acc. to Cushing, angled

Material: Stainless steel

Other Sizes:
003-0255-18 : 17 cm



Forceps
TC forceps, acc. to Cushing-acc. to Taylor

Material: Stainless steel

Other Sizes:
003-0256-18 : 18.5 cm



Forceps
TC dressing forceps, acc. to acc. to Potts-Smith

Material: Stainless steel

Other Sizes:
003-0258-15 : 16 cm
003-0258-18 : 18.5 cm
003-0258-20 : 20 cm
003-0258-23 : 23 cm
003-0258-25 : 25 cm
003-0258-14 : 14.5 cm



Forceps
TC Intestinal grasping forceps, acc. to Oehler, 1 x 2 teeth

Material: Stainless steel

Other Sizes:
003-0260-14 : 14.5 cm
003-0260-16 : 16 cm
003-0260-18 : 18 cm
003-0260-20 : 20 cm
003-0260-25 : 25 cm



Forceps
TC dressing forceps, acc. to Wangenstein

Material: Stainless steel

Other Sizes:
003-0266-15 : 15 cm
003-0266-23 : 23 cm

FORCEPS



Forceps

TC atraumatic forceps, acc. to De Bakey

Material: Stainless steel

Other Sizes:

003-0270-15	16 cm
003-0270-19	20 cm
003-0270-24	24.5 cm



Forceps

TC atraumatic forceps, acc. to De Bakey

Material: Stainless steel

Other Sizes:

003-0272-15	16 cm
003-0272-19	20 cm
003-0272-24	24.5 cm



Forceps

TC atraumatic forceps, 2,7 mm

Material: Stainless steel

Other Sizes:

003-0273-15	16 cm
003-0273-19	20 cm
003-0273-24	24.5 cm



Forceps

TC atraumatic forceps, 3,5 mm

Material: Stainless steel

Other Sizes:

003-0274-15	16 cm
-------------	-------



Forceps

TC dressing forceps, acc. to Jaboma

Material: Stainless steel

Other Sizes:

003-0276-18	18 cm
-------------	-------



Forceps

TC Intestinal grasping forceps, acc. to Jaboma, 1 x 2 teeth

Material: Stainless steel

Other Sizes:

003-0278-18	18 cm
-------------	-------

FORCEPS



Forceps
TC forceps, acc. to Jaboma,
angled, 1 x 2 teeth

Material: Stainless steel

Other Sizes:

003-0279-18	18 cm
-------------	-------



Forceps
Ti atraumatic forceps, 1,0 mm

Material: Stainless steel

Other Sizes:

003-0280-16	16 cm
003-0280-20	20.5 cm
003-0280-24	24.5 cm



Forceps
Ti atraumatic forceps

Material: Stainless steel

Other Sizes:

003-0282-16	16 cm
003-0282-20	20 cm
003-0282-24	24 cm



Forceps
TC atraumatic forceps

Material: Stainless steel

Other Sizes:

003-0284-16	16 cm
003-0284-20	20 cm
003-0284-24	24 cm



Forceps
Atraumatic forceps, acc.
to Gerald, 1,2 mm

Material: Stainless steel

Other Sizes:

003-0285-18	18 cm
003-0285-20	20 cm



Forceps
Ti forceps, plateau, acc.
to Gerald, 1,2 mm

Material: Stainless steel

Other Sizes:

003-0285-18t	18 cm
003-0285-20t	20 cm

FORCEPS



Forceps

Ring forceps, acc. to Gerald,
Ø 1,0 x 0,5 mm

Material: Stainless steel

Other Sizes:

003-0286-18	18 cm
003-0286-20	20 cm



Forceps

Ti ring forceps, acc. to Gerald,
Ø 1,0 x 0,5 mm

Material: Stainless steel

Other Sizes:

003-0286-18t	18 cm
003-0286-20t	20 cm



Forceps

forceps, plateau, acc. to Gerald,
1,0 mm

Material: Stainless steel

Other Sizes:

003-0287-18	18 cm
003-0287-20	20 cm



Forceps

Ti forceps, plateau, acc. to Gerald,
1,0 mm

Material: Stainless steel

Other Sizes:

003-0287-18t	18 cm
003-0287-20t	20 cm



Forceps

Ti atraumatic forceps, 2,8 mm

Material: Stainless steel

Other Sizes:

003-0288-16	16 cm
-------------	-------



Forceps

Intestinal grasping forceps, 1 x 2 teeth

Material: Stainless steel

Other Sizes:

003-0301-10	10.5 cm
003-0301-11	11.5 cm
003-0301-13	13 cm
003-0301-14	14.5 cm
003-0301-16	16 cm
003-0301-18	18 cm
003-0301-20	20 cm
003-0301-23	23 cm
003-0301-25	25 cm
003-0301-30	30.5 cm

FORCEPS



Forceps
Intestinal grasping forceps, 2 x 3 teeth

Material: Stainless steel

Other Sizes:

003-0302-16	15.5 cm
003-0302-11	12 cm
003-0302-13	13 cm
003-0302-14	14.5 cm
003-0302-18	18 cm
003-0302-20	20 cm
003-0302-25	24 cm
003-0302-17	17 cm



Forceps
Intestinal grasping forceps, 1 x 2 teeth, slim

Material: Stainless steel

Other Sizes:

003-0321-13	13 cm
003-0321-14	14.5 cm
003-0321-16	16 cm
003-0321-20	20 cm
003-0321-18	18 cm
003-0321-23	23 cm
003-0321-25	25 cm
003-0321-30	30 cm



Forceps
Intestinal grasping forceps, 3 x 4 teeth

Material: Stainless steel

Other Sizes:

003-0303-14	14.5 cm
003-0303-16	16 cm
003-0303-20	20 cm



Forceps
Intestinal grasping forceps, 4 x 5 teeth

Material: Stainless steel

Other Sizes:

003-0304-14	14.5 cm
003-0304-16	16 cm



Forceps
Dissecting forceps, 1 x 2 teeth, slim, curved

Material: Stainless steel

Other Sizes:

003-0323-15	14.5 cm
-------------	---------



Forceps
Intestinal grasping forceps, 1 x 2 teeth, delicate

Material: Stainless steel

Other Sizes:

003-0326-13	13 cm
003-0326-14	14.5 cm

FORCEPS



Forceps
Intestinal grasping forceps, acc.
to Stille, 1 x 2 teeth

Material: Stainless steel

Other Sizes:
003-0331-15 15 cm



Forceps
Intestinal grasping forceps, acc.
to Stille, 3 x 2 teeth

Material: Stainless steel

Other Sizes:
003-0332-15 15 cm



Forceps
N/A

Material: Stainless steel

Other Sizes:
003-0364-15 15 cm



Forceps
N/A

Material: Stainless steel

Other Sizes:
003-0365-15 15 cm



Forceps
forceps, acc. to Adlerkreutz,
2 x 3 teeth

Material: Stainless steel

Other Sizes:
003-0366-15 15.5 cm
003-0366-20 20.5 cm



Forceps
forceps, acc. to Adlerkreutz,
4 x 5 teeth

Material: Stainless steel

Other Sizes:
003-0367-15 16 cm
003-0367-20 20 cm
003-0367-25 25 cm

FORCEPS



Forceps

Intestinal grasping forceps, acc. to Adson, 1 x 2 teeth

Material: Stainless steel

Other Sizes:

003-0368-12	12 cm
003-0368-15	15 cm



Forceps

Dissecting forceps, acc. to acc. to Gillies, 1 x 2 teeth

Material: Stainless steel

Other Sizes:

003-0370-15	15.5 cm
-------------	---------



Forceps

Dissecting forceps, acc. to Waugh, 1 x 2 teeth

Material: Stainless steel

Other Sizes:

003-0371-20	20.5 cm
003-0371-25	25 cm



Forceps

Dissecting forceps, acc. to Semken, 1 x 2 teeth

Material: Stainless steel

Other Sizes:

003-0372-12	12.5 cm
003-0372-15	15 cm



Forceps

Dissecting forceps, acc. to Brophy, 1 x 2 teeth

Material: Stainless steel

Other Sizes:

003-0373-20	20 cm
-------------	-------



Forceps

Dissecting forceps, acc. to acc. to Taylor, 1 x 2 teeth

Material: Stainless steel

Other Sizes:

003-0374-17	17.5 cm
-------------	---------

FORCEPS



Forceps
Dissecting forceps, acc.
to acc. to Taylor, 1 x 2 teeth

Material: Stainless steel

Other Sizes:
003-0380-17 : 17 cm



Forceps
Dissecting forceps, bayonet-shape,
1 x 2 teeth

Material: Stainless steel

Other Sizes:
003-0383-17 : 18.5 cm



Forceps
Micro forceps, 1 x 2 teeth, 0.6 mm

Material: Stainless steel

Other Sizes:
003-0384-06 : 15.5 cm
003-0384-08 : 15.5 cm
003-0384-10 : 15.5 cm



Forceps
forceps, acc. to Gerald, 1 x 2
teeth, straight

Material: Stainless steel

Other Sizes:
003-0386-17 : 17.5 cm



Forceps
forceps, acc. to Gerald, 1 x 2
teeth, straight

Material: Stainless steel

Other Sizes:
003-0386-23 : 23 cm



Forceps
forceps, acc. to Gerald, 1 x 2
teeth, curved

Material: Stainless steel

Other Sizes:
003-0387-17 : 15.5 cm

FORCEPS



Forceps
Intestinal grasping forceps, acc. to Cushing 1 x 2 teeth

Material: Stainless steel

Other Sizes:
003-0388-17 18 cm



Forceps
forceps, acc. to acc. to Potts-Smith, 1 x 2 teeth

Material: Stainless steel

Other Sizes:
003-0392-18 18 cm
003-0392-21 21 cm
003-0392-25 24 cm
003-0392-30 30 cm



Forceps
forceps, acc. to Adson Brown, 7 x 7 teeth

Material: Stainless steel

Other Sizes:
003-0400-12 12 cm



Forceps
forceps, acc. to Mini-Adson, 1 x 2 teeth

Material: Stainless steel

Other Sizes:
003-0402-012 12 cm



Forceps
forceps, acc. to Mini-Adson, 1 x 2 teeth, curved

Material: Stainless steel

Other Sizes:
003-0403-12 12 cm



Forceps
Dressing forceps, acc. to Mikro-Adson

Material: Stainless steel

Other Sizes:
003-0404-12 12 cm
003-0404-15 15 cm

FORCEPS



Forceps

forceps, acc. to Mikro-Adson,
1 x 2 teeth

Material: Stainless steel

Other Sizes:

003-0406-12	12 cm
003-0406-15	15 cm



Forceps

Micro forceps, delicate, 1 x 2 teeth

Material: Stainless steel

Other Sizes:

003-0408-11	10.5 cm
-------------	---------



Forceps

forceps, jeweler-type, curved, no. 7

Material: Stainless steel

Other Sizes:

003-0409-12	12 cm
-------------	-------



Forceps

forceps, jeweler-type, straight, no. 3

Material: Stainless steel

Other Sizes:

003-0410-12	12 cm
-------------	-------



Forceps

forceps, jeweler-type, straight, no. 3C

Material: Stainless steel

Other Sizes:

003-0412-11	11 cm
-------------	-------



Forceps

forceps, jeweler-type, straight, no. 5

Material: Stainless steel

Other Sizes:

003-0414-11	11 cm
-------------	-------

FORCEPS



Forceps
forceps, jeweler-type, straight, no. 4

Material: Stainless steel

Other Sizes:
003-0416-11 11 cm



Forceps
forceps, jeweler-type, angled down

Material: Stainless steel

Other Sizes:
003-0418-11 11 cm



Forceps
Intestinal grasping forceps, Russian-type

Material: Stainless steel

Other Sizes:
003-0420-15 15 cm
003-0420-20 20 cm
003-0420-25 25.5 cm



Forceps
Intestinal grasping forceps, acc. to Durante

Material: Stainless steel

Other Sizes:
003-0426-14 20.5 cm
003-0426-16 16 cm
003-0426-20 20.5 cm
003-0426-25 25 cm



Forceps
forceps, acc. to Stille-Barraya, 3 x 4 teeth

Material: Stainless steel

Other Sizes:
003-0444-18 18 cm
003-0444-26 26 cm



Forceps
Intestinal grasping forceps, acc. to Booney, 1 x 2 teeth

Material: Stainless steel

Other Sizes:
003-0451-18 17.5 cm

FORCEPS



Forceps
forceps, acc. to Mayo, Russian-type

Material: Stainless steel

Other Sizes:
003-0456-23 : 23 cm



Forceps
forceps, fenestrated jaw

Material: Stainless steel

Other Sizes:
003-0460-18 : 18 cm



Forceps
forceps, fenestrated jaw

Material: Stainless steel

Other Sizes:
003-0460-23 : 23 cm



Forceps
forceps, acc. to acc. to Nelson,
7 x 6 teeth

Material: Stainless steel

Other Sizes:
003-0466-23 : 23 cm



Forceps
forceps, acc. to Resano

Material: Stainless steel

Other Sizes:
003-0467-23 : 23 cm



Forceps
Tubal seizing forceps, isolated jaw

Material: Stainless steel

Other Sizes:
003-0468-18 : 18 cm

FORCEPS



Forceps
Dressing forceps, fine, straight

Material: Stainless steel

Other Sizes:
003-0502-10 : 10 cm



Forceps
Dressing forceps, fine, curved

Material: Stainless steel

Other Sizes:
003-0503-10 : 10 cm



Forceps
Dressing forceps, fine, strongly curved

Material: Stainless steel

Other Sizes:
003-0505-10 : 9.5 cm



Forceps
Intestinal grasping forceps,
1 x 2 teeth, straight

Material: Stainless steel

Other Sizes:
003-0512-10 : 10 cm



Forceps
forceps, fine, 1 x 2 teeth, curved

Material: Stainless steel

Other Sizes:
003-0513-10 : 10 cm



Forceps
forceps, fine, 1 x 2 teeth, strongly curved

Material: Stainless steel

Other Sizes:
003-0515-10 : 9.5 cm

FORCEPS



Forceps

General inst, Description: Micro forceps, tip Ø 0.15 mm

Material: Stainless steel

Other Sizes:

003-0552-01 : 11 cm

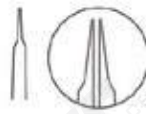

Forceps

Dilating forceps, 10°

Material: Stainless steel

Other Sizes:

003-0552-04 : Ø 0.10 mm, 11 cm
 003-0552-05 : Ø 0.20 mm, 11 cm
 003-0552-06 : Ø 0.30 mm, 11 cm



Forceps

Micro forceps

Material: Stainless steel

Other Sizes:

003-0552-07 : Ø 0.15 mm, 11 cm
 003-0552-08 : Ø 0.20 mm, 11 cm
 003-0552-09 : Ø 0.30 mm, 11 cm

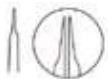

Forceps

Dilating forceps, 10°

Material: Stainless steel

Other Sizes:

003-0552-10 : Ø 0.10 mm, 11 cm
 003-0552-11 : Ø 0.20 mm, 11 cm
 003-0552-12 : Ø 0.30 mm, 11 cm



Forceps

Micro forceps, Ø 0.5 mm, 1 x 2 teeth

Material: Stainless steel

Other Sizes:

003-0553-01 : 11 cm



Forceps

Micro forceps, ring Ø 1.2 mm

Material: Stainless steel

Other Sizes:

003-0553-05 : 11 cm

FORCEPS



Forceps
Micro forceps, triangle-tip

Material: Stainless steel

Other Sizes:
003-0553-06 : 11 cm



Forceps
Micro forceps, Ø 0,5 mm, 1 x 2 teeth

Material: Stainless steel

Other Sizes:
003-0553-07 : 11 cm



Forceps
Micro forceps, ring Ø 1.2 mm

Material: Stainless steel

Other Sizes:
003-0553-08 : 11 cm



Forceps
Micro forceps, triangle-tip

Material: Stainless steel

Other Sizes:
003-0553-09 : 11 cm



Forceps
Micro forceps, straight, 0.3 mm

Material: Stainless steel

Other Sizes:
003-0560-00 : 11 cm
003-0561-00 : 13.5 cm



Forceps
Dilating forceps, 10°, 5 x 0.2 mm

Material: Stainless steel

Other Sizes:
003-0560-02 : 11 cm
003-0561-02 : 11 cm

FORCEPS



Forceps
Dilating forceps, 10°, 5 x 0.3 mm

Material: Stainless steel

Other Sizes:
003-0560-03 11 cm
003-0561-03 13.5 cm



Forceps
Micro forceps, tip "Pierce", straight

Material: Stainless steel

Other Sizes:
003-0560-05 11 cm
003-0561-05 13.5 cm



Forceps
Micro forceps, 45°, 0.3 mm

Material: Stainless steel

Other Sizes:
003-0560-45 11 cm
003-0561-45 13.5 cm



Forceps
Micro forceps, 90°, 0.3 mm

Material: Stainless steel

Other Sizes:
003-0560-90 11 cm
003-0561-90 13.5 cm



Forceps
Micro forceps, straight, 6 x 0.3 mm

Material: Stainless steel

Other Sizes:
003-0562-00 15 cm
003-0563-00 18 cm



Forceps
Micro forceps, counter balance, curved,
6 x 0.3 mm

Material: Stainless steel

Other Sizes:
003-0562-01 15 cm
003-0563-01 18 cm

FORCEPS



Forceps

Micro forceps, counter balance,
45°, 6 x 0.3 mm

Material: Stainless steel

Other Sizes:

003-0562-02	15 cm
003-0563-02	18 cm



Forceps

Ring forceps with weight, 1 x 0.5 mm

Material: Stainless steel

Other Sizes:

003-0562-03	15 cm
003-0563-03	18 cm



Forceps

Micro forceps, counter balance,
straight, 5 x 0.3 mm

Material: Stainless steel

Other Sizes:

003-0562-04	15 cm
003-0563-04	18 cm



Forceps

Micro forceps, counter balance,
straight, tip "Pierse"

Material: Stainless steel

Other Sizes:

003-0562-05	15 cm
003-0563-05	18 cm



Forceps

Micro forceps, straight, 6.0 x 0.4 mm

Material: Stainless steel

Other Sizes:

003-0564-15	15 cm
003-0564-18	18 cm



Forceps

Micro forceps, curved, 6.0 x 0.4 mm

Material: Stainless steel

Other Sizes:

003-0565-15	00 cm
-------------	-------

FORCEPS



Forceps
Micro forceps, straight, 6.0 x 0.7 mm

Material: Stainless steel

Other Sizes:

003-0566-15	15 cm
003-0566-18	18 cm
003-0566-21	21 cm
003-0566-23	23 cm
003-0566-25	25 cm



Forceps
Micro forceps, curved, 6.0 x 0.7 mm

Material: Stainless steel

Other Sizes:

003-0567-15	15 cm
003-0567-18	18 cm
003-0567-21	21 cm
003-0567-23	23 cm
003-0567-25	25 cm



Forceps
Micro forceps, 1 x 2 teeth, straight, 0.4 mm

Material: Stainless steel

Other Sizes:

003-0568-15	15 cm
003-0568-18	18 cm



Forceps
Micro forceps, 1 x 2 teeth, curved, 0.4 mm

Material: Stainless steel

Other Sizes:

003-0569-15	15 cm
003-0569-18	18 cm



Forceps
Micro forceps, 1 x 2 teeth, straight, 0.7 mm

Material: Stainless steel

Other Sizes:

003-0570-15	15 cm
003-0570-18	18 cm
003-0570-21	21 cm
003-0570-23	23 cm



Forceps
Micro forceps, 1 x 2 teeth, curved, 0.7 mm

Material: Stainless steel

Other Sizes:

003-0571-15	15 cm
003-0571-18	18 cm
003-0571-21	21 cm
003-0571-23	23 cm

FORCEPS



Forceps

Micro forceps, straight, 0.4 mm

Material: Stainless steel

Other Sizes:

003-0572-00 18 cm



Forceps

Micro forceps, curved, 0.4 mm

Material: Stainless steel

Other Sizes:

003-0572-01 18 cm



Forceps

Micro forceps, straight, 0.7 mm

Material: Stainless steel

Other Sizes:

003-0572-02 18 cm
 003-0572-04 21 cm
 003-0572-06 23 cm
 003-0572-08 25 cm



Forceps

Micro forceps, curved, 0.7 mm

Material: Stainless steel

Other Sizes:

003-0572-03 18 cm
 003-0572-06 21 cm
 003-0572-07 23 cm
 003-0572-09 25 cm



Forceps

Micro forceps, counter balance,
 curved, Ø 1.0 x 0.5 mm

Material: Stainless steel

Other Sizes:

003-0572-15 18 cm
 003-0572-20 21 cm
 003-0572-25 23 cm
 003-0572-30 25 cm



Forceps

Micro forceps, counter balance,
 Ø 1.0 x 0.5 mm

Material: Stainless steel

Other Sizes:

003-0573-00 18 cm
 003-0573-05 21 cm
 003-0573-10 23 cm
 003-0573-15 25 cm

FORCEPS



Forceps

Micro forceps, counter balance, plateau,
Ø 1.0 x 0.5 mm

Material: Stainless steel

Other Sizes:

003-0573-01	18 cm
003-0573-06	21 cm
003-0573-11	23 cm
003-0573-16	25 cm



Forceps

Micro forceps, counter balance,
Ø 2.0 mm x 1.0 mm

Material: Stainless steel

Other Sizes:

003-0573-02	18 cm
003-0573-07	21 cm
003-0573-12	23 cm
003-0573-17	25 cm



Forceps

Micro forceps, counter balance, plateau,
Ø 2.0 mm x 1.0 mm

Material: Stainless steel

Other Sizes:

003-0573-03	18 cm
003-0573-08	21 cm
003-0573-13	23 cm
003-0573-18	25 cm



Forceps

Micro forceps, counter balance,
atraumatic, 1.2 mm

Material: Stainless steel

Other Sizes:

003-0573-04	18 cm
003-0573-09	21 cm
003-0573-14	23 cm
003-0573-19	25 cm



Forceps

Ring forceps, straight, Ø 1.0 x 0.5 mm

Material: Stainless steel

Other Sizes:

003-0574-15	15 cm
003-0574-18	18 cm
003-0574-21	21 cm
003-0574-23	23 cm



Forceps

Ring forceps, curved, Ø 1,0x0,5 mm

Material: Stainless steel

Other Sizes:

003-0575-15	15 cm
003-0575-18	18 cm
003-0575-21	21 cm
003-0575-23	23 cm
003-0575-25	25 cm

FORCEPS



Forceps

Ring forceps, straight,
Ø 2.0 mm x 1.0 mm

Material: Stainless steel

Other Sizes:

003-0576-15	15 cm
003-0576-18	18 cm
003-0576-21	21 cm
003-0576-23	23 cm



Forceps

Ti micro forceps, straight, 6.0 x 0.4 mm

Material: Stainless steel

Other Sizes:

003-0578-15	15 cm
003-0578-18	18 cm



Forceps

Ti micro forceps, curved, 6.0 x 0.4 mm

Material: Stainless steel

Other Sizes:

003-0579-15	15 cm
003-0579-18	18 cm



Forceps

Ti micro forceps, straight, 6.0 x 0.8 mm

Material: Stainless steel

Other Sizes:

003-0580-15	15 cm
003-0580-18	18 cm
003-0580-21	21 cm
003-0580-23	23 cm
003-0580-25	25 cm



Forceps

Ti micro forceps, curved, 6.0 x 0.8 mm

Material: Stainless steel

Other Sizes:

003-0581-1	15 cm
003-0581-18	18 cm
003-0581-21	21 cm
003-0581-23	23 cm
003-0581-25	25 cm

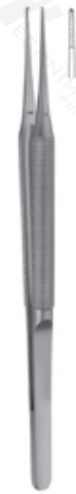

Forceps

Micro forceps, straight, 1 x 2 teeth, 0.4 mm

Material: Stainless steel

Other Sizes:

003-0582-15	15 cm
003-0582-18	18 cm

FORCEPS



Forceps

Micro forceps, curved, 1 x 2 teeth, 0.4 mm

Material: Stainless steel

Other Sizes:

003-0583-15	15 cm
003-0583-18	18 cm



Forceps

Micro forceps, straight, 1 x 2 teeth, 0.8 mm

Material: Stainless steel

Other Sizes:

003-0584-15	15 cm
003-0584-18	18 cm
003-0584-21	21 cm



Forceps

Micro forceps, curved, 1 x 2 teeth, 0.8 mm

Material: Stainless steel

Other Sizes:

003-0585-15	15 cm
003-0585-18	18 cm
003-0585-21	21 cm



Forceps

Ti ring forceps, straight, Ø 1.0 x 0.5 mm

Material: Stainless steel

Other Sizes:

003-0586-15	15 cm
003-0586-18	18 cm
003-0586-21	21 cm
003-0586-23	23 cm
003-0586-25	25 cm



Forceps

Ti ring forceps, curved, Ø 1.0 x 0.5 mm

Material: Stainless steel

Other Sizes:

003-0587-15	15 cm
003-0587-18	18 cm
003-0587-21	21 cm
003-0587-23	23 cm
003-0587-25	25 cm



Forceps

Ti ring forceps, straight, 2.0 x 1.0 mm

Material: Stainless steel

Other Sizes:

003-0588-15	15 cm
003-0588-18	18 cm
003-0588-21	21 cm
003-0588-23	23 cm
003-0588-25	25 cm

FORCEPS



Forceps

Micro forceps, atraumatic, straight, 1.2 mm

Material: Stainless steel

Other Sizes:

003-0589-15	15 cm
003-0589-18	18 cm
003-0589-21	21 cm
003-0589-23	23 cm
003-0589-25	25 cm



Forceps

Ti micro forceps, atraumatic, straight, 1.2 mm

Material: Stainless steel

Other Sizes:

003-0590-15	15 cm
003-0590-18	18 cm
003-0590-21	21 cm
003-0590-23	23 cm
003-0590-25	25 cm



Forceps

Micro forceps, straight, 6 x 0.4 mm

Material: Stainless steel

Other Sizes:

003-0591-00	15 cm
003-0592-00	18 cm



Forceps

Micro forceps, curved, 6 x 0.4 mm

Material: Stainless steel

Other Sizes:

003-0591-01	15 cm
003-0592-01	18 cm



Forceps

Micro forceps, 45°, 6 x 0.4 mm

Material: Stainless steel

Other Sizes:

003-0591-02	15 cm
003-0592-02	18 cm



Forceps

Micro forceps, straight, 5 x 0.3 mm

Material: Stainless steel

Other Sizes:

003-0591-04	15 cm
003-0592-04	18 cm

FORCEPS



Forceps
Micro forceps, straight, PIERSE

Material: Stainless steel

Other Sizes:
003-0591-05 : 15 cm
003-0592-05 : 18 cm



Forceps
Splinter forceps, smooth, straight

Material: Stainless steel

Other Sizes:
003-0600-12 : 12.5 cm



Forceps
Splinter forceps, smooth

Material: Stainless steel

Other Sizes:
003-0601-12 : 12.5 cm



Forceps
Splinter forceps, serrated, straight

Material: Stainless steel

Other Sizes:
003-0604-09 : 9 cm
003-0604-11 : 10.5 cm
003-0604-12 : 12.5 cm



Forceps
Splinter forceps, serrated, curved

Material: Stainless steel

Other Sizes:
003-0605-09 : 9 cm
003-0605-12 : 12 cm



Forceps
Micro tying forceps, bayonet-shape

Material: Stainless steel

Other Sizes:
003-0616-16 : 15.5 cm

FORCEPS



Forceps
Tying forceps, acc. to Lazar

Material: Stainless steel

Other Sizes:
003-0618-16 : 0.5 mm, 15.5 cm
003-0619-16 : 0.8 mm, 15.5 cm



Forceps
Tying forceps, with plateau, 0.3 mm

Material: Stainless steel

Other Sizes:
003-0624-12 : 12 cm



Forceps
Tying forceps, acc. to Austin, 0.8 mm

Material: Stainless steel

Other Sizes:
003-0626-14 : 14 cm



Forceps
Splinter forceps, acc. to FeilChenfeld

Material: Stainless steel

Other Sizes:
003-0630-07 : 7.5 cm
003-0630-09 : 9 cm
003-0630-11 : 11.5 cm



Forceps
Splinter forceps, acc. to Hunter, straight

Material: Stainless steel

Other Sizes:
003-0640-10 : 10.5 cm



Forceps
Splinter forceps, acc. to Hunter, curved

Material: Stainless steel

Other Sizes:
003-0641-10 : 10.5 cm

FORCEPS



Forceps
Microscopy forceps, straight

Material: Stainless steel

Other Sizes:
003-0655-10 10 cm



Forceps
Microscopy forceps, angled down

Material: Stainless steel

Other Sizes:
003-0656-10 10 cm



Forceps
N/A

Material: Stainless steel

Other Sizes:
003-0657-10 10 cm



Forceps
N/A

Material: Stainless steel

Other Sizes:
003-0659-10 10 cm



Forceps
Foreign body forceps, acc. to Shaaf

Material: Stainless steel

Other Sizes:
003-0661-09 9.5 cm



Forceps
Cilia forceps, acc. to Littauer

Material: Stainless steel

Other Sizes:
003-0664-08 8.5 cm

FORCEPS



Forceps
Cilia forceps, serrated, oblique

Material: Stainless steel

Other Sizes:
003-0666-09 : 8.5 cm



Forceps
Cilia forceps, acc. to Douglas, narrow

Material: Stainless steel

Other Sizes:
003-0674-09 : 9 cm



Forceps
Cilia forceps, acc. to Douglas, wide

Material: Stainless steel

Other Sizes:
003-0676-09 : 9 cm



Forceps
Cilia forceps, acc. to Beer, smooth

Material: Stainless steel

Other Sizes:
003-0680-09 : 9 cm



Forceps
Cilia forceps, acc. to Barraquer, angled

Material: Stainless steel

Other Sizes:
003-0695-10 : 10.5 cm



Forceps
Splinter forceps, acc. to Stieglitz, straight

Material: Stainless steel

Other Sizes:
003-0720-13 : 14 cm

FORCEPS



Forceps

Splinter forceps, acc. to Stieglitz, curved

Material: Stainless steel

Other Sizes:

003-0721-13 : 13.5 cm



Forceps

Splinter forceps, acc. to Pietz angled

Material: Stainless steel

Other Sizes:

003-0725-11 : 12.5 cm



Forceps

Splinter forceps, acc. to Ralk, straight

Material: Stainless steel

Other Sizes:

003-0740-15 : 15 cm



Forceps

Splinter forceps, acc. to Ralk, curved

Material: Stainless steel

Other Sizes:

003-0741-15 : 15 cm



Forceps

Ring forceps, straight, plateau, Ø 1.0 x 0.5 mm

Material: Stainless steel

Other Sizes:

003-0774-15 : 15 cm
003-0774-18 : 18 cm
003-0774-21 : 21 cm
003-0774-23 : 23 cm
003-0774-25 : 25 cm



Forceps

Ring forceps, straight, plateau, Ø 2.0 mm x 1.0 mm

Material: Stainless steel

Other Sizes:

003-0776-15 : 15 cm
003-0776-18 : 18 cm
003-0776-21 : 21 cm
003-0776-23 : 23 cm
003-0776-25 : 25 cm

FORCEPS



Forceps

Ti ring forceps, straight, plateau, Ø 1.0 x 0.5 mm

Material: Stainless steel

Other Sizes:

003-0786-15	15 cm
003-0786-18	18 cm
003-0786-21	21 cm
003-0786-23	23 cm
003-0786-25	25 cm



Forceps

Ti ring forceps, straight, plateau, Ø 2.0 mm x 1.0 mm

Material: Stainless steel

Other Sizes:

003-0787-15	15 cm
003-0787-18	18 cm
003-0787-21	21 cm
003-0787-23	23 cm
003-0787-25	25 cm



Forceps

Dressing forceps, acc. to Martin, straight

Material: Stainless steel

Other Sizes:

005-0120-17	17.5 cm
-------------	---------

ARTERY FORCEPS

— RANGE

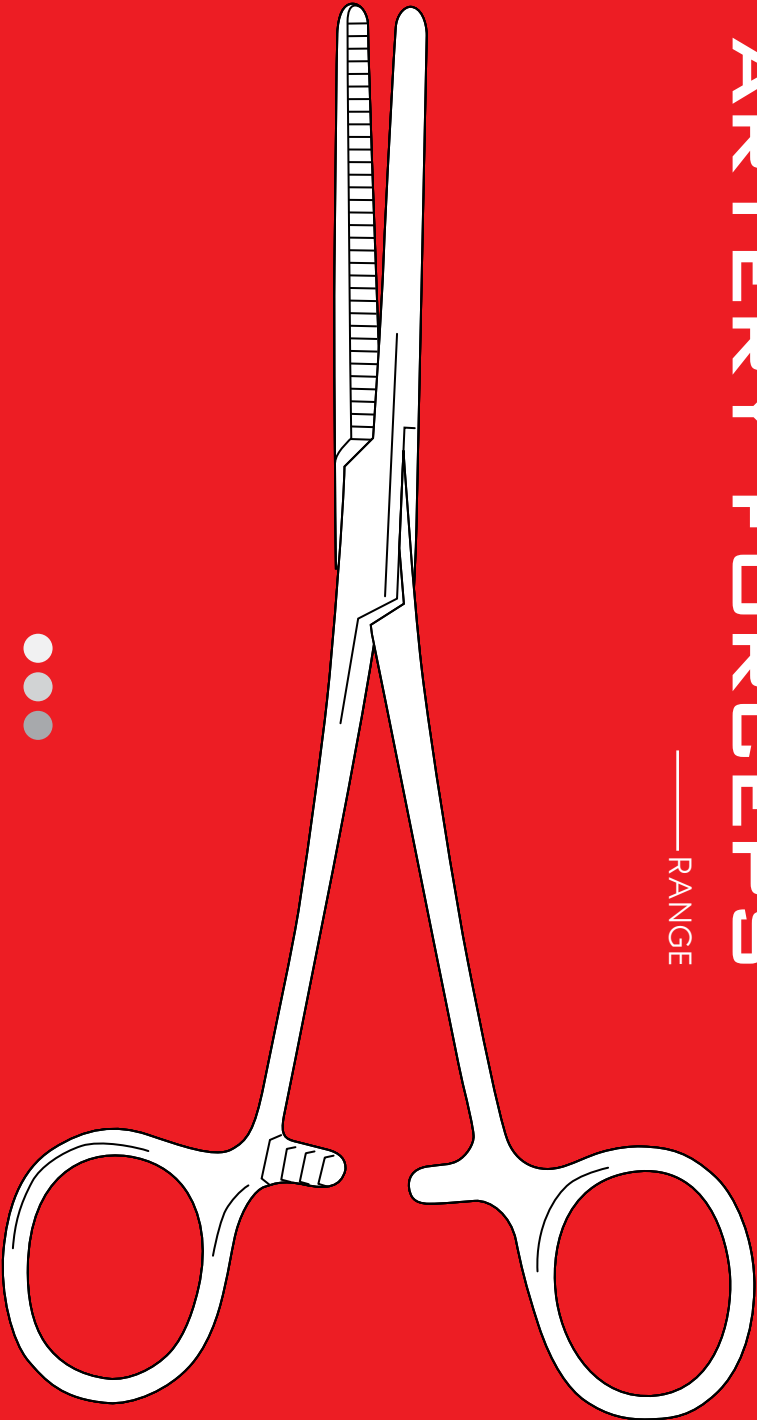

DISCOVER NOW

“Instruments for
surgical procedures”
Since 1970

ARTERY FORCEPS



Artery Forceps
Vascular spreader, acc. to Biemer

Material: Stainless steel

Other Sizes:
004-0010-00 : 16 cm



Artery Forceps
Clip applying forceps, without lock

Material: Stainless steel

Other Sizes:
004-0050-14 : 14.5 cm



Artery Forceps
Clip applying forceps, with lock

Material: Stainless steel

Other Sizes:
004-0051-14 : 14.5 cm



Artery Forceps
Vascular clip, acc. to Biemer

Material: Stainless steel

Other Sizes:
004-0052-04 : 6 cm



Artery Forceps
Vascular clip, acc. to Biemer

Material: Stainless steel

Other Sizes:
004-0052-05 : 9 cm



Artery Forceps
Vascular clip, acc. to Biemer, SLIM

Material: Stainless steel

Other Sizes:
004-0053-05 : N/A

ARTERY FORCEPS



Artery Forceps

Approximator, acc. to Biemer-Mueller, straight

Material: Stainless steel

Other Sizes:
004-0054-05 : N/A



Artery Forceps

Approximator, acc. to Biemer-Mueller, angled

Material: Stainless steel

Other Sizes:
004-0055-05 : N/A



Artery Forceps

Approximator, acc. to Biemer-Mueller

Material: Stainless steel

Other Sizes:
004-0056-03 : 4.5 mm



Artery Forceps

Approximator, acc. to Biemer-Mueller

Material: Stainless steel

Other Sizes:
004-0058-05 : 9 mm



Artery Forceps

Approximator, acc. to Biemer-Mueller, angled

Material: Stainless steel

Other Sizes:
003-0134-20 : 20 cm



Artery Forceps

Approximator, acc. to Mueller

Material: Stainless steel

Other Sizes:
004-0060-01 : 1.0 mm

ARTERY FORCEPS



Artery Forceps

Approximator, acc. to Mueller

Material: Stainless steel

Other Sizes:

004-0060-02 : 2.0 mm



Artery Forceps

Approximator, acc. to Mueller

Material: Stainless steel

Other Sizes:

004-0060-03 : 3.0 mm



Artery Forceps

Approximator, acc. to Mueller

Material: Stainless steel

Other Sizes:

004-0060-04 : 4.0 mm



Artery Forceps

Approximator for deep areas

Material: Stainless steel

Other Sizes:

004-0062-00 : N/A



Artery Forceps

Key for approximators

Material: Stainless steel

Other Sizes:

004-0062-01 : N/A

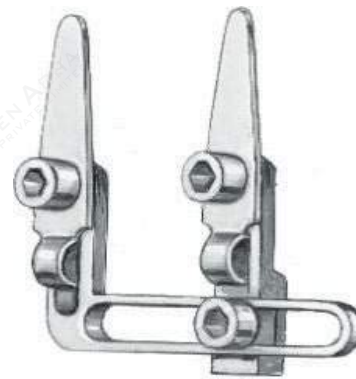

Artery Forceps

Approximator, only

Material: Stainless steel

Other Sizes:

004-0062-02 : N/A

ARTERY FORCEPS



Artery Forceps
Nerv approximator, complete

Material: Stainless steel

Other Sizes:
004-0063-00 : N/A

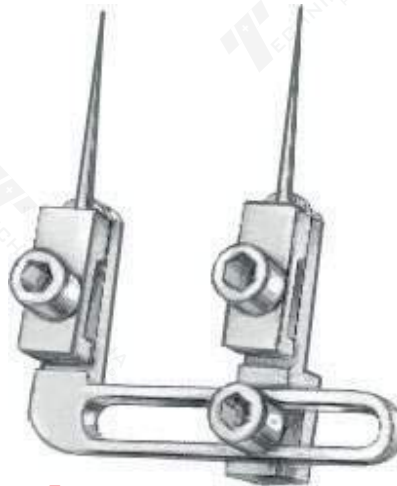

Artery Forceps
Nerv approximator, only

Material: Stainless steel

Other Sizes:
004-0063-02 : N/A

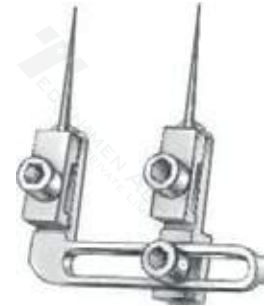

Artery Forceps
needle for nerv approximator, pair

Material: Stainless steel

Other Sizes:
004-0063-04 : N/A

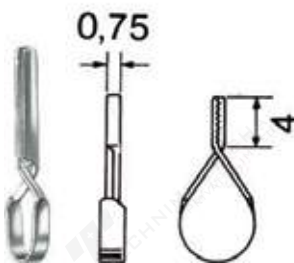

Artery Forceps
Mini vascular clip

Material: Stainless steel

Other Sizes:
004-0102-04 : jaw 4.0 x 0.75 mm
004-0102-06 : jaw 6.0 x 1.0 mm
004-0102-08 : jaw 8.0 x 2.0 mm
004-0102-10 : jaw 10.0 x 2.0 mm



Artery Forceps
Applying forceps for mini clips

Material: Stainless steel

Other Sizes:
004-0104-14 : 14.5 cm



Artery Forceps
Applying forceps for mini clips, bayonet-shape

Material: Stainless steel

Other Sizes:
004-0106-18 : 18.5 cm

ARTERY FORCEPS



Artery Forceps
Bulldog clamp, lightweight, straight

Material: Stainless steel

Other Sizes:

004-0108-10	31 mm
004-0108-14	35 mm
004-0108-18	39 mm

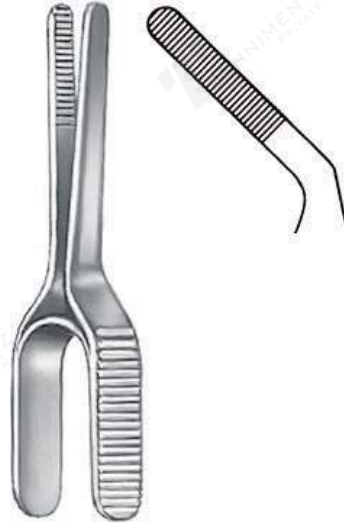

Artery Forceps
Bulldog clamp, lightweight, angled

Material: Stainless steel

Other Sizes:

004-0109-10	30 mm
004-0109-14	33 mm
004-0109-18	36 mm



Artery Forceps
Bulldog clamp, acc. to Dieffenbach, straight

Material: Stainless steel

Other Sizes:

004-0110-06	6 cm
-------------	------



Artery Forceps
Bulldog clamp, acc. to Dieffenbach, curved

Material: Stainless steel

Other Sizes:

004-0111-06	6 cm
-------------	------



Artery Forceps
Bulldog clamp, acc. to Dieffenbach, straight

Material: Stainless steel

Other Sizes:

004-0114-03	3.5 cm
004-0114-05	5 cm



Artery Forceps
Bulldog clamp, acc. to Dieffenbach, curved

Material: Stainless steel

Other Sizes:

004-0115-03	3.5 cm
004-0115-05	5 cm

ARTERY FORCEPS



Artery Forceps
Bulldog clamp, acc. to Johns Hopkins, straight

Material: Stainless steel

Other Sizes:

004-0115-38	38 mm
004-0115-45	45 mm
004-0115-55	55 mm
004-0115-65	65 mm
004-0115-70	70 mm
004-0115-75	75 mm
004-0115-90	90 mm



Artery Forceps
Bulldog clamp, acc. to Johns Hopkins, curved

Material: Stainless steel

Other Sizes:

004-0116-38	38 mm
004-0116-45	45 mm
004-0116-55	55 mm
004-0116-65	65 mm
004-0116-70	70 mm
004-0116-75	75 mm
004-0116-90	90 mm



Artery Forceps
Bulldog clamp, acc. to Johns Hopkins, curved

Material: Stainless steel

Other Sizes:

004-0119-05	5 cm
004-0119-06	6 cm
004-0119-07	7 cm



Artery Forceps
Bulldog clamp, acc. to Diethrich, straight

Material: Stainless steel

Other Sizes:

004-0120-08	8 mm
004-0120-10	10 mm
004-0120-12	12 mm



Artery Forceps
Bulldog clamp, acc. to Diethrich, curved

Material: Stainless steel

Other Sizes:

004-0121-08	8 mm
004-0121-10	10 mm
004-0121-12	12 mm



Artery Forceps
Bulldog clamp, atraumatic, straight

Material: Stainless steel

Other Sizes:

004-0122-10	10 mm
004-0122-14	14 mm
004-0122-20	20 mm

ARTERY FORCEPS



Artery Forceps

Bulldog clamp, atraumatic, angled

Material: Stainless steel

Other Sizes:

004-0123-10	10 mm
004-0123-14	14 mm
004-0123-20	20 mm



Artery Forceps

1- Vessel clip, acc. to Mueller, straight, closing pressure 50 grams 2- Vessel clip, acc. to Mueller, straight, closing pressure 80 grams

Material: Stainless steel

Other Sizes:

004-0124-11	N/A
004-0124-16	N/A



Artery Forceps

1-Vessel clip, acc. to Mueller, curved, closing pressure 50 grams 2-Vessel clip, acc. to Mueller, curved, closing pressure 80 grams

Material: Stainless steel

Other Sizes:

004-0124-12	N/A
004-0124-17	N/A



Artery Forceps

1-Vessel clip, acc. to Mueller, tip curved, closing pressure 50 grams 2-Vessel clip, acc. to Mueller, tip curved, closing pressure 80 grams

Material: Stainless steel

Other Sizes:

004-0124-13	N/A
004-0124-18	N/A



Artery Forceps

1-Vessel clip, acc. to Mueller, angled, closing pressure 50 grams 2-Vessel clip, acc. to Mueller, angled, closing pressure 80 grams

Material: Stainless steel

Other Sizes:

004-0124-14	N/A
004-0124-19	N/A



Artery Forceps

1-Vessel clip, acc. to Mueller, knee-bent, closing pressure 50 grams 2-Vessel clip, acc. to Mueller, knee-bent, closing pressure 80 grams

Material: Stainless steel

Other Sizes:

004-0124-15	N/A
004-0124-20	N/A

ARTERY FORCEPS



Artery Forceps

1-Bulldog clip, jaw angled, closing pressure 250 grams
2-Bulldog clip, jaw angled, closing pressure 350 grams

Material: Stainless steel

Other Sizes:

004-0124-25	N/A
004-0124-29	N/A

Artery Forceps

1-Bulldog clip, jaw z-shaped, closing pressure 250 grams
2-Bulldog clip, jaw z-shaped, closing pressure 350 grams

Material: Stainless steel

Other Sizes:

004-0124-26	N/A
004-0124-30	N/A

Artery Forceps

1-Bulldog clip, jaw spoon-shaped, closing pressure 250 grams
2-Bulldog clip, jaw spoon-shaped, closing pressure 350 grams

Material: Stainless steel

Other Sizes:

004-0124-27	N/A
004-0124-31	N/A



Artery Forceps

1-Bulldog clip, jaw angled/curved upwards closing pressure 250 grams
2-Bulldog clip, jaw angled/curved upwards, closing pressure 350 grams

Material: Stainless steel

Other Sizes:

004-0124-28	N/A
004-0124-32	N/A



Artery Forceps

Atraumatic bulldog clamp, curved

Material: Stainless steel

Other Sizes:

004-0125-10	10 mm
004-0125-14	14 mm
004-0125-20	20 mm



Artery Forceps

Ti bulldog clamp, atraumatic, straight

Material: titanium

Other Sizes:

004-0126-10	10 mm
004-0126-14	14 mm
004-0126-20	20 mm

ARTERY FORCEPS



Artery Forceps

Ti bulldog clamp, atraumatic, angled

Material: titanium

Other Sizes:

004-0127-10	10 mm
004-0127-14	14 mm
004-0127-20	20 mm



Artery Forceps

Ti bulldog clamp, atraumatic, curved

Material: Stainless steel

Other Sizes:

004-0128-10	10 mm
004-0128-14	14 mm
004-0128-20	20 mm



Artery Forceps

Applying forceps, acc. to Mini-acc. to Glover

Material: Stainless steel

Other Sizes:

004-0131-24	24 cm
-------------	-------



Artery Forceps

Ti bulldog clamp, for veins, straight

Material: titanium

Other Sizes:

004-0132-30	30 mm
004-0132-35	35 mm
004-0132-40	40 mm
004-0132-50	50 mm



Artery Forceps

Ti bulldog clamp, for veins, curved

Material: titanium

Other Sizes:

004-0133-30	30 mm
004-0133-35	35 mm
004-0133-40	40 mm
004-0133-50	50 mm



Artery Forceps

Ti bulldog clamp, for veins, strongly curved

Material: titanium

Other Sizes:

004-0135-30	30 mm
004-0135-35	35 mm
004-0135-40	40 mm
004-0135-50	50 mm

ARTERY FORCEPS



Artery Forceps

Ti bulldog clamp, for arteries, straight

Material: Stainless steel

Other Sizes:

004-0142-30	30 cm
004-0142-35	35 mm
004-0142-40	40 mm
004-0142-50	50 mm



Artery Forceps

Ti bulldog clamp, for arteries, curved

Material: titanium

Other Sizes:

004-0143-30	30 mm
004-0143-35	35 mm
004-0143-40	40 mm
004-0143-50	50 mm



Artery Forceps

Ti bulldog clamp, for arteries, strongly curved

Material: titanium

Other Sizes:

004-0145-30	30 mm
004-0145-35	35 mm
004-0145-40	40 mm
004-0145-50	50 mm



Artery Forceps

forceps, acc. to Pean, straight, short jaw

Material: Stainless steel

Other Sizes:

004-0176-14	14.5 cm
004-0176-16	16 cm



Artery Forceps

forceps, acc. to Spencer-Wellis, straight

Material: Stainless steel

Other Sizes:

004-0248-13	13 cm
004-0248-14	14 cm
004-0248-15	15.5 cm
004-0248-18	18.5 cm
004-0248-20	20 cm



Artery Forceps

forceps, acc. to Spencer-Wellis, curved

Material: Stainless steel

Other Sizes:

004-0249-13	13 cm
004-0249-14	14 cm
004-0249-15	15 cm
004-0249-18	18 cm
004-0249-20	20 cm

ARTERY FORCEPS



Artery Forceps
forceps, acc. to Chaput, straight, 2 x 3 teeth

Material: Stainless steel

Other Sizes:
004-0256-13 : 12.5 cm



Artery Forceps
forceps, acc. to Tuffier, straight, 5 x 6 teeth

Material: Stainless steel

Other Sizes:
004-0258-13 : 12.5 cm



Artery Forceps
Organ seizing forceps, atraumatic

Material: Stainless steel

Other Sizes:
004-0266-25 : 25 cm
004-0266-26 : 26 cm



Artery Forceps
forceps, acc. to Collin, triangled jaw

Material: Stainless steel

Other Sizes:
004-0268-14 : 14 cm



Artery Forceps
forceps, acc. to Collin, oval JAW

Material: Stainless steel

Other Sizes:
004-0278-17 : 17 cm

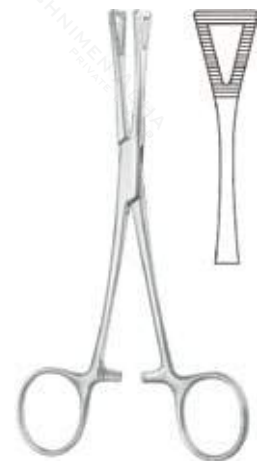

Artery Forceps
forceps, acc. to Pennington, triangled jaw

Material: Stainless steel

Other Sizes:
004-0280-15 : 15.5 cm
004-0280-20 : 21 cm

ARTERY FORCEPS



Artery Forceps
forceps, acc. to Pratt, T-shaped jaw

Material: Stainless steel

Other Sizes:
004-0282-15 15 cm



Artery Forceps
Face lift forceps, acc. to Martel-Rees

Material: Stainless steel

Other Sizes:
004-0290-14 13.5 cm



Artery Forceps
Ligature forceps, straight, smooth

Material: Stainless steel

Other Sizes:
004-0302-12 12.5 cm



Artery Forceps
forceps, acc. to Mixer-Baby, slightly curved

Material: Stainless steel

Other Sizes:
004-0303-01 13.5 cm



Artery Forceps
forceps, acc. to Mixer-Baby, straight curved

Material: Stainless steel

Other Sizes:
004-0303-02 13 cm



Artery Forceps
Hemostatic forceps, acc. to Micro-Adson

Material: Stainless steel

Other Sizes:
004-0304-14 14 cm

ARTERY FORCEPS



Artery Forceps

Hemostatic forceps, acc. to Baby-Adson

Material: Stainless steel

Other Sizes:

004-0305-18 : 18 cm



Artery Forceps

Hemostatic forceps, acc. to Hartmann, straight

Material: Stainless steel

Other Sizes:

004-0306-10 : 10 cm



Artery Forceps

Hemostatic forceps, acc. to Hartmann, curved

Material: Stainless steel

Other Sizes:

004-0307-10 : 9.5 cm



Artery Forceps

Ligature forceps, serrated, curved

Material: Stainless steel

Other Sizes:

004-0309-12 : 12.5 cm



Artery Forceps

Hemostatic forceps, acc. to Mosquito, straight

Material: Stainless steel

Other Sizes:

004-0310-12 : 12.5 cm
004-0310-14 : 14.5 cm



Artery Forceps

Ti hemostatic forceps, Mosquito, straight

Material: Stainless steel

Other Sizes:

004-0310-62 : 12.5 cm

ARTERY FORCEPS



Artery Forceps
Hemostatic forceps, acc.
to Mosquito, curved

Material: Stainless steel

Other Sizes:

004-0311-12	12 cm
004-0311-14	14 cm



Artery Forceps
Ti hemostatic forceps, acc.
to Mosquito, curved

Material: titanium

Other Sizes:

004-0311-62	12 cm
-------------	-------



Artery Forceps
Hemostatic forceps, acc.
to Mosquito, 1 x 2 teeth, straight

Material: Stainless steel

Other Sizes:

004-0312-12	12.5 cm
004-0312-14	14.5 cm



Artery Forceps
Ti hemostatic forceps, acc.
to Mosquito, 1 x 2 teeth, straight

Material: titanium

Other Sizes:

004-0312-62	12 cm
-------------	-------



Artery Forceps
Hemostatic forceps, acc.
to Mosquito, 1 x 2 teeth, curved

Material: Stainless steel

Other Sizes:

004-0313-12	12 cm
004-0313-14	14 cm



Artery Forceps
Ti hemostatic forceps, acc.
to Mosquito, 1 x 2 teeth, curved

Material: titanium

Other Sizes:

004-0313-62	12 cm
-------------	-------

ARTERY FORCEPS



Artery Forceps

Hemostatic forceps, acc. to Mosquito, straight

Material: Stainless steel

Other Sizes:

004-0316-18	18.5 cm
004-0316-21	21 cm



Artery Forceps

Hemostatic forceps, acc. to Mosquito, curved

Material: Stainless steel

Other Sizes:

004-0317-18	18 cm
004-0317-21	20.5 cm



Artery Forceps

Hemostatic forceps, acc. to Mosquito, 1 x 2 teeth, straight

Material: Stainless steel

Other Sizes:

004-0318-18	18.5 cm
004-0318-21	21 cm



Artery Forceps

Hemostatic forceps, acc. to Mosquito, 1 x 2 teeth, curved

Material: Stainless steel

Other Sizes:

004-0319-18	18 cm
004-0319-21	20.5 cm



Artery Forceps

Micro hemostatic forceps, acc. to Mosquito, straight

Material: Stainless steel

Other Sizes:

004-0320-10	12 cm
-------------	-------



Artery Forceps

Micro hemostatic forceps, acc. to Mosquito, curved

Material: Stainless steel

Other Sizes:

004-0321-10	9.5 cm
004-0321-12	11.5 cm

ARTERY FORCEPS



Artery Forceps

Micro hemostatic forceps, acc. to Mosquito, 1 x 2 teeth, straight

Material: Stainless steel

Other Sizes:

004-0322-10	10 cm
004-0322-12	12 cm



Artery Forceps

Micro forceps, acc. to Mosquito, 1 x 2 teeth, curved

Material: Stainless steel

Other Sizes:

004-0323-10	10 cm
004-0323-12	12 cm



Artery Forceps

Hemostatic forceps, Providence-Hospital-style, straight

Material: Stainless steel

Other Sizes:

004-0324-14	14 cm
-------------	-------



Artery Forceps

Hemostatic forceps, Providence-Hospital-style, curved

Material: Stainless steel

Other Sizes:

004-0325-14	14 cm
-------------	-------



Artery Forceps

Hemostatic forceps, acc. to LeriChe, straight

Material: Stainless steel

Other Sizes:

004-0326-15	15.5 cm
-------------	---------



Artery Forceps

Hemostatic forceps, acc. to LeriChe, curved

Material: Stainless steel

Other Sizes:

004-0327-15	15 cm
-------------	-------

ARTERY FORCEPS



Artery Forceps
forceps, acc. to LeriChe, 1 x 2 teeth, straight

Material: Stainless steel

Other Sizes:
004-0328-15 : 15.5 cm



Artery Forceps
forceps, acc. to LeriChe, 1 x 2 teeth, curved

Material: Stainless steel

Other Sizes:
004-0329-15 : 15 cm



Artery Forceps
Hemostatic forceps, acc. to Kelly. straight

Material: Stainless steel

Other Sizes:
004-0330-14 : 14.5 cm



Artery Forceps
Ti hemostatic forceps, acc. to Kelly. straight

Material: titanium

Other Sizes:
004-0330-64 : 14.5 cm
004-0331-64 : 14 cm



Artery Forceps
Hemostatic forceps, acc. to Kelly. curved

Material: Stainless steel

Other Sizes:
004-0331-14 : 14 cm



Artery Forceps
Hemostatic forceps, acc. to Dunhill, straight

Material: Stainless steel

Other Sizes:
004-0332-12 : 12.5 cm

ARTERY FORCEPS



Artery Forceps

Hemostatic forceps, acc. to Dunhill, curved

Material: Stainless steel

Other Sizes:

004-0333-19 : 18.5 cm

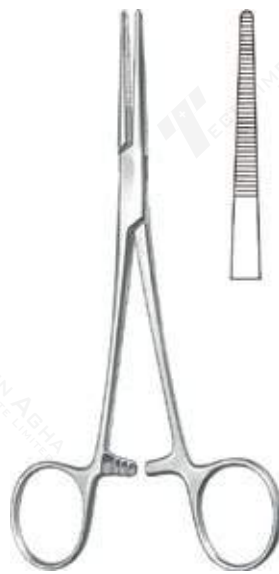

Artery Forceps

Hemostatic forceps, acc. to Kelly-acc. to Rankin, straight

Material: Stainless steel

Other Sizes:

004-0334-16 : 16 cm



Artery Forceps

Hemostatic forceps, acc. to Kelly-acc. to Rankin, curved

Material: Stainless steel

Other Sizes:

004-0335-16 : 15.5 cm



Artery Forceps

Dissecting forceps, acc. to Overholt, curved

Material: Stainless steel

Other Sizes:

004-0339-14 : 14 cm



Artery Forceps

Hemostatic forceps, acc. to Crile, straight

Material: Stainless steel

Other Sizes:

004-0340-14 : 14.5 cm



Artery Forceps

Ti hemostatic forceps, acc. to Crile, straight

Material: Stainless steel

Other Sizes:

004-0340-64 : 14.5 cm

ARTERY FORCEPS



Artery Forceps

Hemostatic forceps, acc. to Crile, curved

Material: Stainless steel

Other Sizes:

004-0341-14 : 14 cm



Artery Forceps

Ti hemostatic forceps, acc. to Crile, curved

Material: Stainless steel

Other Sizes:

004-0341-64 : 14 cm



Artery Forceps

Hemostatic forceps, acc. to Crile, 1 x 2 teeth, straight

Material: Stainless steel

Other Sizes:

004-0342-14 : 20.5 cm



Artery Forceps

Hemostatic forceps, acc. to Crile, 1 x 2 teeth, curved

Material: Stainless steel

Other Sizes:

004-0343-14 : 20.5 cm



Artery Forceps

Hemostatic forceps, acc. to Crile-acc. to Rankin, straight

Material: Stainless steel

Other Sizes:

004-0346-16 : 17 cm



Artery Forceps

Hemostatic forceps, acc. to Crile-acc. to Rankin, curved

Material: Stainless steel

Other Sizes:

004-0347-16 : 17 cm

ARTERY FORCEPS



Artery Forceps
Hemostatic forceps, acc.
to acc. to Lovelace, straight

Material: Stainless steel

Other Sizes:
004-0348-15 17 cm



Artery Forceps
Hemostatic forceps, acc. to acc.
to Lovelace, 1 x 2 teeth, straight

Material: Stainless steel

Other Sizes:
004-0350-15 17 cm



Artery Forceps
Hemostatic forceps, acc.
to Dandy-Mosquito, curved

Material: Stainless steel

Other Sizes:
004-0351-12 12 cm



Artery Forceps
Hemostatic forceps, acc.
to Dandy, curved sideways

Material: Stainless steel

Other Sizes:
004-0355-14 14.5 cm



Artery Forceps
Hemostatic forceps, acc.
to Dandy, 1 x 2 teeth, curved

Material: Stainless steel

Other Sizes:
004-0357-14 14.5 cm



Artery Forceps
Hemostatic forceps, acc.
to Schnid, strongly curved

Material: Stainless steel

Other Sizes:
004-0363-18 18.5 cm

ARTERY FORCEPS



Artery Forceps

Hemostatic forceps, acc. to Schnidt, slightly curved

Material: Stainless steel

Other Sizes:

004-0363-19 : 19 cm



Artery Forceps

Hemostatic forceps, acc. to Adson, straight

Material: Stainless steel

Other Sizes:

004-0364-18 : 19 cm



Artery Forceps

Hemostatic forceps, acc. to Adson, curved

Material: Stainless steel

Other Sizes:

004-0365-18 : 18.5 cm



Artery Forceps

Hemostatic forceps, acc. to Martin-Fuchs, curved

Material: Stainless steel

Other Sizes:

004-0369-20 : 20.5 cm



Artery Forceps

Hemostatic forceps, acc. to Rochester-Carmalt, straight

Material: Stainless steel

Other Sizes:

004-0370-16 : 17 cm
004-0370-20 : 20.5 cm



Artery Forceps

Hemostatic forceps, acc. to Rochester-Carmalt, curved

Material: Stainless steel

Other Sizes:

004-0371-16 : 16.5 cm
004-0371-20 : 20 cm

ARTERY FORCEPS



Artery Forceps

Hemostatic forceps, acc. to Pean, delicate, straight

Material: Stainless steel

Other Sizes:

004-0374-13	13.5 cm
004-0374-14	14.5 cm
004-0374-16	16 cm



Artery Forceps

Hemostatic forceps, acc. to Pean, delicate, curved

Material: Stainless steel

Other Sizes:

004-0375-13	13 cm
004-0375-14	14 cm
004-0375-16	16.5 cm



Artery Forceps

Hemostatic forceps, acc. to Pean-Nippon, straight

Material: Stainless steel

Other Sizes:

004-0380-14	14.5 cm
004-0380-16	16.5 cm
004-0380-18	18.5 cm



Artery Forceps

Hemostatic forceps, acc. to Pean-Nippon, curved

Material: Stainless steel

Other Sizes:

004-0381-14	14 cm
004-0381-16	16 cm
004-0381-18	18 cm



Artery Forceps

Hemostatic forceps, acc. to KoCher-Nippon, 1 x 2 teeth, curved

Material: Stainless steel

Other Sizes:

004-0383-14	14.5 cm
004-0383-16	16 cm
004-0383-18	18 cm



Artery Forceps

Hemostatic forceps, acc. to KoCher, 1 x 2 teeth, straight

Material: Stainless steel

Other Sizes:

004-0384-13	13 cm
004-0384-14	14 cm
004-0384-16	16 cm

ARTERY FORCEPS



Artery Forceps
Hemostatic forceps, acc. to KoCher,
1 x 2 teeth, curved

Material: Stainless steel

Other Sizes:

004-0385-13	13 cm
004-0385-14	14 cm
004-0385-16	16 cm



Artery Forceps
Hemostatic forceps, acc.
to Bengolea, straight

Material: Stainless steel

Other Sizes:

004-0390-20	21.5 cm
004-0390-26	26 cm



Artery Forceps
Hemostatic forceps, acc
to Bengolea, curved

Material: Stainless steel

Other Sizes:

004-0391-20	21 cm
004-0391-26	25.5 cm



Artery Forceps
Hemostatic forceps, acc.
to Bengolea, 1 x 2 teeth, straight

Material: Stainless steel

Other Sizes:

004-0392-20	21.5 cm
004-0392-26	26 cm



Artery Forceps
Hemostatic forceps, acc.
to Bengolea, 1 x 2 teeth, curved

Material: Stainless steel

Other Sizes:

004-0393-20	21 cm
004-0393-26	25.5 cm



Artery Forceps
Hemostatic forceps, acc. to Pean, straight

Material: Stainless steel

Other Sizes:

004-0410-14	14.5 cm
004-0410-16	16.5 cm
004-0410-20	20.5 cm
004-0410-22	22.5 cm
004-0410-24	24.5 cm
004-0410-26	26 cm
004-0410-30	30.5 cm

ARTERY FORCEPS



Artery Forceps

Hemostatic forceps, acc. to Pean, curved

Material: Stainless steel

Other Sizes:

004-0411-14	14 cm
004-0411-16	16 cm
004-0411-18	18 cm
004-0411-20	20 cm
004-0411-22	22 cm
004-0411-24	24 cm
004-0411-26	26 cm
004-0411-30	30 cm



Artery Forceps

Hemostatic forceps, acc. to KoCher,
1 x 2 teeth, straight

Material: Stainless steel

Other Sizes:

004-0414-14	14.5 cm
004-0414-16	16.5 cm
004-0414-18	18.5 cm
004-0414-20	20.5 cm
004-0414-22	22.5 cm
004-0414-24	24.5 cm
004-0414-26	26 cm
004-0414-30	30.5 cm



Artery Forceps

Hemostatic forceps, acc.
to KoCher, 1 x 2 teeth, curved

Material: Stainless steel

Other Sizes:

004-0415-14	14 cm
004-0415-16	16 cm
004-0415-18	18 cm
004-0415-20	20 cm
004-0415-22	22 cm
004-0415-24	24 cm
004-0415-26	25.5 cm
004-0415-30	30 cm



Artery Forceps

Dissecting forceps, acc. to Overholt-Martin, S

Material: Stainless steel

Other Sizes:

004-0417-01	18.5 cm
004-0417-02	20.5 cm
004-0417-03	21 cm
004-0417-04	21.5 cm
004-0417-05	24.5 cm



Artery Forceps

Dissecting forceps, acc.
to Baby-Mixer, curved

Material: Stainless steel

Other Sizes:

004-0419-18	18.5 cm
-------------	---------



Artery Forceps

Dissecting forceps, acc.
to Baby-Adson, curved

Material: Stainless steel

Other Sizes:

004-0421-14	14.5 cm
004-0421-18	18 cm

ARTERY FORCEPS



Artery Forceps

Dissecting forceps, acc. to Heiss, straight

Material: Stainless steel

Other Sizes:
004-0422-20 : 21 cm



Artery Forceps

Dissecting forceps, acc. to Heiss, slightly curved

Material: Stainless steel

Other Sizes:
004-0423-20 : 20.5 cm



Artery Forceps

Dissecting forceps, acc. to Heiss, strongly curved

Material: Stainless steel

Other Sizes:
004-0425-20 : 20 cm



Artery Forceps

Dissecting forceps, acc. to Overholt-Mixer, curved

Material: Stainless steel

Other Sizes:
004-0427-21 : 21.5 cm



Artery Forceps

Hemostatic forceps, acc. to Roberts, straight

Material: Stainless steel

Other Sizes:
004-0428-22 : 22.5 cm



Artery Forceps

Hemostatic forceps, acc. to Roberts, curved

Material: Stainless steel

Other Sizes:
004-0429-22 : 21.5 cm

ARTERY FORCEPS



Artery Forceps

Hemostatic forceps, acc. to Sarot, straight

Material: Stainless steel

Other Sizes:

004-0432-24 : 25 cm



Artery Forceps

Hemostatic forceps, acc. to Sarot, curved

Material: Stainless steel

Other Sizes:

004-0433-24 : 24.5 cm



Artery Forceps

Hemostatic forceps, acc. to Crafoord, curved

Material: Stainless steel

Other Sizes:

004-0439-18 : 18 cm
004-0439-24 : 24.5 cm



Artery Forceps

Hemostatic forceps, acc. to Crafoord Sellors, curved

Material: Stainless steel

Other Sizes:

004-0440-01 : 24.5 cm



Artery Forceps

Hemostatic forceps, acc. to Crafoord Sellors, medium curved

Material: Stainless steel

Other Sizes:

004-0440-02 : 23 cm



Artery Forceps

Hemostatic forceps, acc. to Crafoord Sellors, strongly curved

Material: Stainless steel

Other Sizes:

004-0440-03 : 22 cm

ARTERY FORCEPS



Artery Forceps

Dissecting forceps, acc. to Overholt, no. 1

Material: Stainless steel

Other Sizes:

004-0443-01	20.5 cm
004-0447-01	27 cm



Artery Forceps

Dissecting forceps, acc. to Overholt, no. 2

Material: Stainless steel

Other Sizes:

004-0443-02	20 cm
004-0447-02	26.5 cm

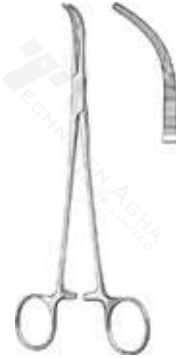

Artery Forceps

Dissecting forceps, acc. to Overholt, no. 3

Material: Stainless steel

Other Sizes:

004-0443-03	21.5 cm
004-0447-03	27.5 cm



Artery Forceps

Dissecting forceps, acc. to Overholt, no. 4

Material: Stainless steel

Other Sizes:

004-0443-04	22 cm
004-0447-04	28 cm



Artery Forceps

Dissecting forceps, acc. to Overholt, no. 5

Material: Stainless steel

Other Sizes:

004-0443-05	22 cm
004-0447-05	27.5 cm



Artery Forceps

Dissecting forceps, acc. to Overholt, no. 6

Material: Stainless steel

Other Sizes:

004-0443-06	22 cm
004-0447-06	28 cm

ARTERY FORCEPS



Artery Forceps

Dissecting forceps, acc. to Overholt no. 7

Material: Stainless steel

Other Sizes:

004-0443-07	22 cm
004-0447-07	27.5 cm



Artery Forceps

Hemostatic forceps, acc. to Overholt, fine, curved

Material: Stainless steel

Other Sizes:

004-0448-00	21.5 cm
004-0448-01	21 cm
004-0448-02	22 cm
004-0448-03	23 cm
004-0448-04	22.5 cm



Artery Forceps

Hemostatic forceps, acc. to Overholt, fine, curved

Material: Stainless steel

Other Sizes:

004-0449-00	29.5 cm
004-0449-01	29.5 cm
004-0449-06	30 cm



Artery Forceps

Hemostatic forceps, acc. to Overholt Mini, s-shape

Material: Stainless steel

Other Sizes:

004-0450-01	15 cm
004-0450-02	20 cm



Artery Forceps

Dissecting forceps, acc. to Gemini, straight curved

Material: Stainless steel

Other Sizes:

004-0451-13	13 cm
004-0451-16	16 cm
004-0451-18	18 cm
004-0451-20	21 cm
004-0451-23	23 cm
004-0451-25	25 cm
004-0451-28	28 cm



Artery Forceps

Dissecting forceps, acc. to Gemini, straight curved

Material: Stainless steel

Other Sizes:

004-0451-13	13 cm
004-0451-16	16 cm
004-0451-18	18 cm
004-0451-20	20 cm
004-0451-23	23 cm
004-0451-25	25 cm
004-0451-28	28 cm

ARTERY FORCEPS



Artery Forceps

Dissecting forceps, acc. to Mini-Gemini, curved

Material: Stainless steel

Other Sizes:

004-0453-18	18 cm
004-0453-22	22.5 cm
004-0453-25	25 cm
004-0453-28	28.5 cm



Artery Forceps

Dissecting forceps, acc. to Rumel

Material: Stainless steel

Other Sizes:

004-0461-01	24 cm
004-0461-02	23.5 cm
004-0461-03	23 cm
004-0461-04	24 cm
004-0461-05	23.5 cm



Artery Forceps

Dissecting forceps, acc. to Zenker, slightly curved

Material: Stainless steel

Other Sizes:

004-0469-01	29.5 cm
-------------	---------



Artery Forceps

Dissecting forceps, acc. to Zenker, strongly curved

Material: Stainless steel

Other Sizes:

004-0469-02	28.5 cm
-------------	---------



Artery Forceps

Dissecting forceps, acc. to Mixer-Baby, curved

Material: Stainless steel

Other Sizes:

004-0471-14	13.5 cm
-------------	---------



Artery Forceps

Dissecting forceps, acc. to Mixer, angled

Material: Stainless steel

Other Sizes:

004-0473-15	16 cm
004-0473-19	18 cm

ARTERY FORCEPS



Artery Forceps

Dissecting forceps, acc. to O'Shaughnessy

Material: Stainless steel

Other Sizes:

004-0479-14	15 cm
004-0479-17	18 cm
004-0479-19	18.5 cm
004-0479-20	20 cm
004-0479-23	23 cm
004-0479-26	26 cm



Artery Forceps

Dissecting forceps, acc. to Mixer, curved

Material: Stainless steel

Other Sizes:

004-0483-22	22.5 cm
-------------	---------



Artery Forceps

Dissecting forceps, acc. to Wickstroem, angled

Material: Stainless steel

Other Sizes:

004-0487-21	21 cm
004-0487-24	24.5 cm



Artery Forceps

Dissecting forceps, acc. to Mixer, angled, longitudinal serration

Material: Stainless steel

Other Sizes:

004-0491-22	22.5 cm
-------------	---------



Artery Forceps

Dissecting forceps, acc. to Mixer, angled, longitudinal serration

Material: Stainless steel

Other Sizes:

004-0493-25	26 cm
-------------	-------



Artery Forceps

Dissecting forceps, acc. to Mixer, angled, longitudinal serration

Material: Stainless steel

Other Sizes:

004-0495-28	28 cm
-------------	-------

ARTERY FORCEPS



Artery Forceps

Dissecting forceps, acc. to McQuigg, angled

Material: Stainless steel

Other Sizes:

004-0497-22 23.5 cm



Artery Forceps

forceps, acc. to Lower, longitudinal serration, angled

Material: Stainless steel

Other Sizes:

004-0501-18 18.5 cm



Artery Forceps

forceps, acc. to acc. to Lahey, longitudinal serration, curved

Material: Stainless steel

Other Sizes:

004-0511-19 19.5 cm



Artery Forceps

forceps, acc. to acc. to Lahey, longitudinal serration, curved

Material: Stainless steel

Other Sizes:

004-0513-23 22.5 cm



Artery Forceps

forceps, acc. to FinocChietto, angled

Material: Stainless steel

Other Sizes:

004-0521-24 24 cm



Artery Forceps

Uro tangential forceps, atraumatic, no. 1

Material: Stainless steel

Other Sizes:

004-0527-01 25 cm

ARTERY FORCEPS



Artery Forceps

Uro tangential forceps, atraumatic, no. 2

Material: Stainless steel

Other Sizes:

004-0527-02 : 27 cm



Artery Forceps

Kidney pedicle forceps, acc. to Guyon, atraumatic

Material: Stainless steel

Other Sizes:

004-0529-23 : 23 cm
004-0529-24 : 24 cm



Artery Forceps

Kidney pedicle forceps, acc. to Guyon

Material: Stainless steel

Other Sizes:

004-0531-20 : 19.5 cm
004-0531-22 : 21.5 cm
004-0531-24 : 24 cm



Artery Forceps

Kidney pedicle forceps, acc. to Guyon, long

Material: Stainless steel

Other Sizes:

004-0533-23 : 24 cm



Artery Forceps

Dissecting forceps, acc. to Kelly, slightly curved

Material: Stainless steel

Other Sizes:

004-0577-19 : 19.5 cm
004-0577-22 : 22.5 cm
004-0577-24 : 24.5 cm



Artery Forceps

Dissecting forceps, acc. to Kelly, medium curved

Material: Stainless steel

Other Sizes:

004-0579-19 : 19 cm
004-0579-22 : 22 cm
004-0579-24 : 24 cm

ARTERY FORCEPS



Artery Forceps

Dissecting forceps, acc. to Kelly, strongly curved

Material: Stainless steel

Other Sizes:

004-0581-19	18.5 cm
004-0581-22	21.5 cm
004-0581-24	23.5 cm



Artery Forceps

Dissecting forceps, acc. to Lawrence

Material: Stainless steel

Other Sizes:

004-0583-28	28 cm
-------------	-------



Artery Forceps

Dissecting forceps, acc. to Meeker, angled

Material: Stainless steel

Other Sizes:

004-0585-28	28 cm
-------------	-------



Artery Forceps

forceps, acc. to Negus, wide curved

Material: Stainless steel

Other Sizes:

004-0595-19	19.5 cm
-------------	---------



Artery Forceps

Hysterectomy forceps, acc. to Heaney 1 teeth, curved

Material: Stainless steel

Other Sizes:

004-0613-19	19.5 cm
004-0613-21	21.5 cm
004-0613-23	24 cm



Artery Forceps

Hysterectomy forceps, acc. to Heaney 2 teeth, curved

Material: Stainless steel

Other Sizes:

004-0615-19	19.5 cm
004-0615-21	21.5 cm
004-0615-23	24 cm

ARTERY FORCEPS



Artery Forceps
forceps, acc. to Phaneuf, 1 x 2
teeth, angled

Material: Stainless steel

Other Sizes:
004-0601-21 : 20 cm



Artery Forceps
Hysterectomy forceps, acc.
to Heaney 1 teeth, curved

Material: Stainless steel

Other Sizes:
004-0613-19 : 19.5 cm
004-0613-21 : 21.5 cm
004-0613-23 : 24 cm



Artery Forceps
Hysterectomy forceps, acc.
to Heaney 2 teeth, curved

Material: Stainless steel

Other Sizes:
004-0615-19 : 19.5 cm
004-0615-21 : 21.5 cm
004-0615-23 : 24 cm



Artery Forceps
clamp forceps, acc. to Wertheim-Cullen

Material: Stainless steel

Other Sizes:
004-0625-21 : 21 cm



Artery Forceps
Parametrium forceps, no. 1

Material: Stainless steel

Other Sizes:
004-0635-10 : 21.5 cm
004-0637-10 : 25.5 cm



Artery Forceps
Parametrium forceps, no. 2

Material: Stainless steel

Other Sizes:
004-0635-20 : 21 cm
004-0637-20 : 25 cm

ARTERY FORCEPS



Artery Forceps
Parametrium forceps, no. 3

Material: Stainless steel

Other Sizes:
004-0635-30 : 20.5 cm
004-0637-30 : 25 cm



Artery Forceps
Parametrium forceps, no. 4

Material: Stainless steel

Other Sizes:
004-0635-40 : 20 cm



Artery Forceps
clamp forceps, acc. to Moynihan, curved

Material: Stainless steel

Other Sizes:
004-0671-23 : 23 cm



Artery Forceps
clamp forceps, acc. to Moynihan, curved

Material: Stainless steel

Other Sizes:
004-0673-24 : 23.5 cm



Artery Forceps
clamp forceps, acc. to Wertheim, curved

Material: Stainless steel

Other Sizes:
004-0697-25 : 26 cm



Artery Forceps
Hysterectomy forceps, acc. to Wertheim, 1 x 2 teeth, curved

Material: Stainless steel

Other Sizes:
004-0717-22 : 22.5 cm

ARTERY FORCEPS



Artery Forceps
Peritoneum forceps, acc.
to Baby-Milkulicz

Material: Stainless steel

Other Sizes:
004-0721-14 : 14.5 cm



Artery Forceps
Peritoneum forceps, acc. to Milkulicz

Material: Stainless steel

Other Sizes:
004-0725-18 : 18.5 cm



Artery Forceps
Peritoneum forceps, acc. to Milkulicz

Material: Stainless steel

Other Sizes:
004-0727-20 : 20 cm



Artery Forceps
Peritoneum forceps, acc.
to Milkulicz, HEAVY

Material: Stainless steel

Other Sizes:
004-0745-20 : 20 cm



Artery Forceps
Peritoneum forceps, acc. to Milkulicz

Material: Stainless steel

Other Sizes:
004-0749-21 : 20.5 cm



Artery Forceps
Peritoneum forceps, acc. to acc.
to Faure, slightly curved

Material: Stainless steel

Other Sizes:
004-0751-20 : 21 cm

ARTERY FORCEPS



Artery Forceps
Peritoneum forceps, acc. to acc. to Faure, strongly curved

Material: Stainless steel

Other Sizes:
004-0753-20 : 21 cm



Artery Forceps
Bulldog towel forceps, acc. to SChaedel

Material: Stainless steel

Other Sizes:
004-0875-09 : 9 cm



Artery Forceps
Bulldog towel forceps, acc. to Jones

Material: Stainless steel

Other Sizes:
004-0881-05 : 5.5 cm
004-0881-09 : 8.5 cm



Artery Forceps
Towel forceps, acc. to Jones, with clip

Material: Stainless steel

Other Sizes:
004-0883-09 : 8.5 cm



Artery Forceps
Towel forceps, sharp, gracile

Material: Stainless steel

Other Sizes:
004-0909-11 : 11.5 cm
004-0909-13 : 13 cm



Artery Forceps
Towel forceps, sharp, with clip

Material: Stainless steel

Other Sizes:
004-0913-11 : 11.5 cm

ARTERY FORCEPS



Artery Forceps

Towel forceps, acc. to Backhaus, sharp

Material: Stainless steel

Other Sizes:

004-0915-08	9 cm
004-0915-11	5.5 cm
004-0915-13	13 cm
004-0915-15	16 cm

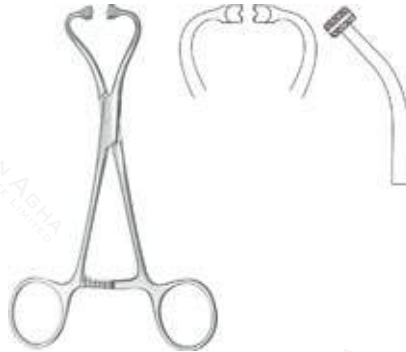

Artery Forceps

Towel forceps, wide, for tube fixation

Material: Stainless steel

Other Sizes:

004-0916-15	15.5 cm
-------------	---------



Artery Forceps

Towel forceps, acc. to Roeder

Material: Stainless steel

Other Sizes:

004-0917-13	13.5 cm
-------------	---------



Artery Forceps

Towel forceps, acc. to Loma, fine serrated

Material: Stainless steel

Other Sizes:

004-0919-10	9.5 cm
004-0919-13	13 cm



Artery Forceps

Towel forceps, acc. to Bernhard, straight

Material: Stainless steel

Other Sizes:

004-0921-16	16.5 cm
-------------	---------



Artery Forceps

Towel forceps, acc. to Tohoku, blunt

Material: Stainless steel

Other Sizes:

004-0923-10	10.5 cm
004-0923-13	13.5 cm

ARTERY FORCEPS



Artery Forceps
Towel forceps, acc. to Peers-Bertram

Material: Stainless steel

Other Sizes:
004-0923-14 : 14.5 cm



Artery Forceps
Towel forceps, for paper drapes

Material: Stainless steel

Other Sizes:
004-0924-11 : 11.5 cm
004-0924-14 : 14 cm



Artery Forceps
Towel forceps, acc. to acc. to Lane, straight

Material: Stainless steel

Other Sizes:
004-0935-20 : 19.5 cm



Artery Forceps
Tube clamp, long ratChet

Material: Stainless steel

Other Sizes:
004-0940-14 : 14 cm



Artery Forceps
Tube clamp, smooth jaw

Material: Stainless steel

Other Sizes:
004-0942-16 : 16.5 cm



Artery Forceps
Tube clamp, Standard type

Material: Stainless steel

Other Sizes:
004-0944-15 : 15.5 cm
004-0944-18 : 19 cm
004-0944-20 : 20.5 cm



Artery Forceps

Tube clamp, with protection clip

Material: Stainless steel

Other Sizes:

004-0946-15	15.5 cm
004-0946-18	19 cm
004-0946-20	20.5 cm

Artery Forceps

Tube milking clamp, acc. to Brompton, aluminium

Material: all other, not specially marked material types

Other Sizes:

004-0948-01	16.5 cm
-------------	---------

Artery Forceps

Tube milking clamp, acc. to Gacc. to Unnar-Hey

Material: Stainless steel

Other Sizes:

13-948-02-07	18 cm
--------------	-------

GOTTON SWAB

— RANGE

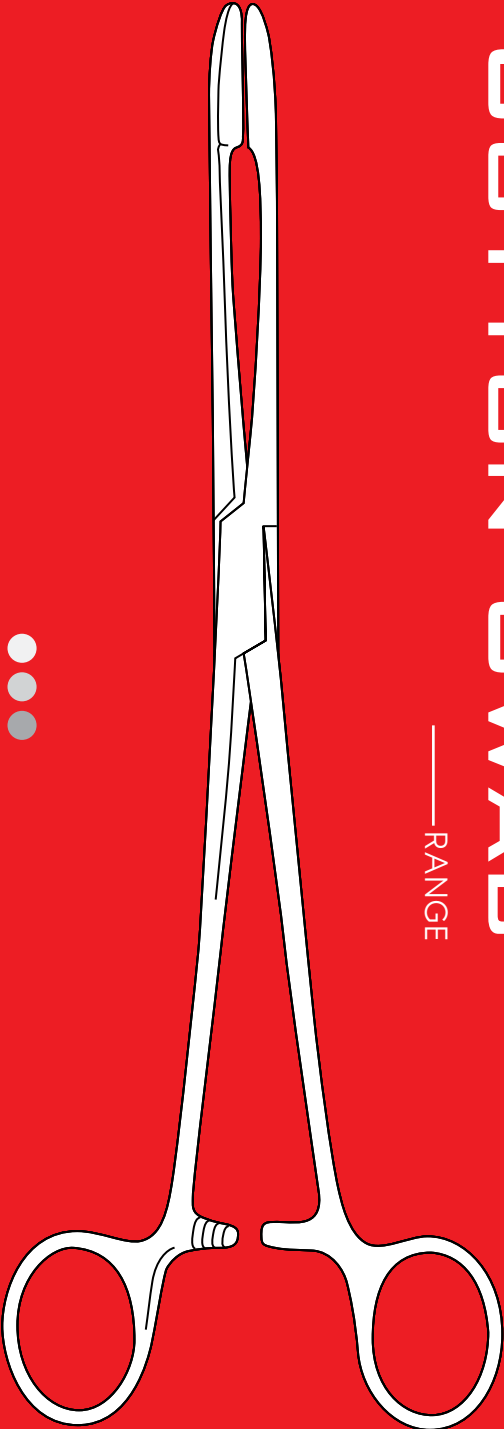

[DISCOVER NOW](#)

“Instruments for
surgical procedures”
Since 1970

COTTON SWAB



Cotton Swab

Tampon forceps, acc. to UlriCh, straight

Material: Stainless steel

Other Sizes:

005-0100-22	22.5 cm
005-0100-27	26.5 cm



Cotton Swab

Tampon forceps, acc. to UlriCh, curved

Material: Stainless steel

Other Sizes:

005-0101-22	22.5 cm
-------------	---------

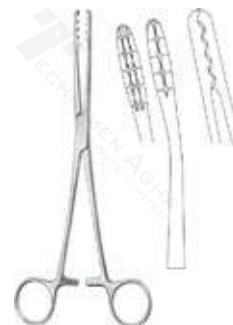

Cotton Swab

Tampon forceps, acc. to UlriCh, curved

Material: Stainless steel

Other Sizes:

005-0101-27	22.5 cm
-------------	---------



Cotton Swab

Sinus forceps, acc. to Lister, straight

Material: Stainless steel

Other Sizes:

005-0110-13	13 cm
005-0110-16	16 cm
005-0110-18	18 cm



Cotton Swab

Dressing forceps, acc. to Martin, straight

Material: Stainless steel

Other Sizes:

005-0120-17	17.5 cm
-------------	---------



Cotton Swab

N/A

Material: Stainless steel

Other Sizes:

005-0121-17	17.5 cm
-------------	---------

COTTON SWAB



Cotton Swab
forceps, acc. to Gross-Maier, straight

Material: Stainless steel

Other Sizes:

005-0222-20	20.5 cm
005-0222-22	22 cm
005-0222-27	26.5 cm



Cotton Swab
forceps, acc. to Gross-Maier, curved

Material: Stainless steel

Other Sizes:

005-0223-20	20 cm
005-0223-22	21.5 cm
005-0223-27	26 cm



Cotton Swab
Tunneling forceps, curved

Material: Stainless steel

Other Sizes:

005-0231-40	39.5 cm
-------------	---------



Cotton Swab
Tampon forceps, acc. to Collin, straight

Material: Stainless steel

Other Sizes:

005-0286-25	25.5 cm
-------------	---------



Cotton Swab
Tampon forceps, acc. to Cheron,
bayonet-shape

Material: Stainless steel

Other Sizes:

005-0290-25	23.5 cm
-------------	---------



Cotton Swab
Sponge forceps, acc. to Bozemann,
s-shape

Material: Stainless steel

Other Sizes:

005-0313-26	26 cm
-------------	-------

COTTON SWAB



Cotton Swab

Sponge forceps, acc. to Bergmann straight

Material: Stainless steel

Other Sizes:

005-0320-24 24 cm



Cotton Swab

forceps, acc. to Foerster, smooth, straight

Material: Stainless steel

Other Sizes:

005-0350-25 25 cm

Available jaw Sizes:

8 mm
10 mm
12 mm



Cotton Swab

forceps, acc. to Foerster, serrated, straight

Material: Stainless steel

Other Sizes:

005-0352-18 18 cm
005-0352-20 20.5 cm
005-0352-25 25 cm

Available jaw Sizes:

8 mm
10 mm
12 mm



Cotton Swab

forceps, acc. to Foerster, smooth, curved

Material: Stainless steel

Other Sizes:

005-0353-25 24.5 cm

Available jaw Sizes:

8 mm
10 mm
12 mm



Cotton Swab

forceps, acc. to Foerster, serrated, curved

Material: Stainless steel

Other Sizes:

005-0355-18 17.5 cm
005-0355-20 20 cm
005-0355-25 24.5 cm

Available jaw Sizes:

8 mm
10 mm
12 mm



Cotton Swab

forceps, acc. to Foerster, slim, straight

Material: Stainless steel

Other Sizes:

005-0360-25 25 cm

COTTON SWAB



Cotton Swab
forceps, acc. to Foerster, slim, curved

Material: Stainless steel

Other Sizes:
005-0361-25 24.5 cm



Cotton Swab
Sponge forceps, acc. to Rampley, straight

Material: Stainless steel

Other Sizes:
005-0370-18 18.5 cm
005-0370-25 24.5 cm

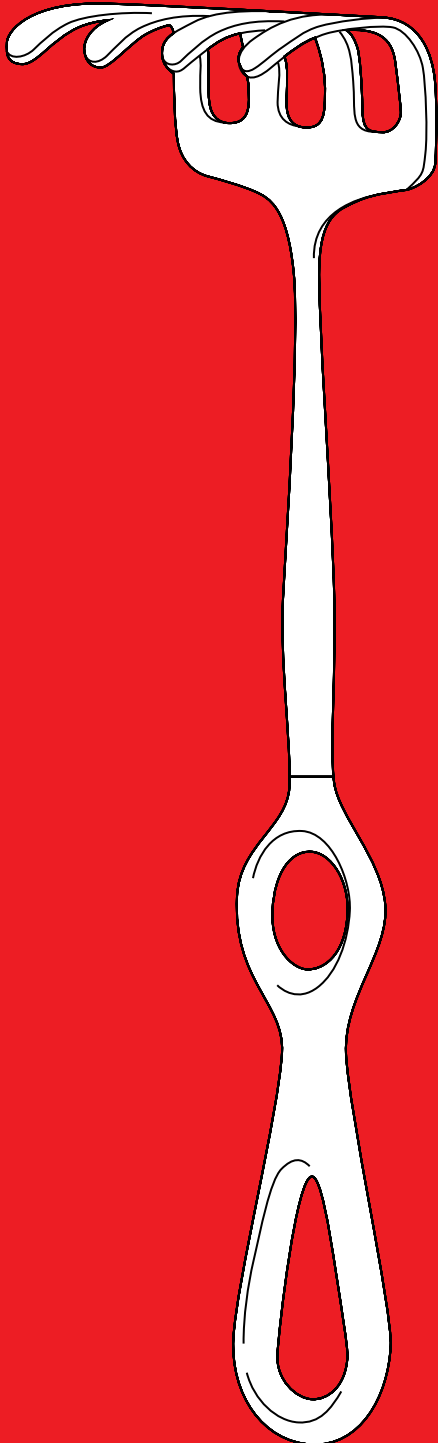

RETRACTORS

— RANGE

DISCOVER NOW

“Instruments for
surgical procedures”
Since 1970

RETRACTORS



Retractors
Bone hooklet, acc. to Rasse, 1 prong

Material: Stainless steel

Other Sizes:
006-0006-10 16 cm



Retractors
Micro hooklet, acc. to Graefe, sharp

Material: Stainless steel

Other Sizes:
006-0066-01 15 cm



Retractors
Micro hooklet, acc. to Graefe, blunt

Material: Stainless steel

Other Sizes:
006-0066-02 15 cm



Retractors
Micro hook, sharp, 1 prong

Material: Stainless steel

Other Sizes:
006-0068-01 16 cm
006-0068-02 16 cm
006-0068-03 16 cm
006-0068-04 16 cm



Retractors
Micro hooklet, acc. to Rasse, sharp

Material: Stainless steel

Other Sizes:
006-0068-05 16 cm



Retractors
Hooklet, acc. to O'Connor, sharp, 1 prong

Material: Stainless steel

Other Sizes:
006-0070-16 16 cm

RETRACTORS



Retractors
Hooklet, acc. to Guthrie, sharp, 2 prongs

Material: Stainless steel

Other Sizes:
006-0072-01 : 15.5 cm
006-0072-02 : 15.5 cm



Retractors
Hooklet, sharp, 1 prong

Material: Stainless steel

Other Sizes:
006-0074-01 : 16.5 cm



Retractors
Hooklet, sharp, 2 prongs

Material: Stainless steel

Other Sizes:
006-0074-02 : 16.5 cm



Retractors
Hook-let, sharp, 3 prongs

Material: Stainless steel

Other Sizes:
006-0074-03 : 16.5 cm



Retractors
Hooklet, sharp, 4 prongs

Material: Stainless steel

Other Sizes:
006-0074-04 : 16.5 cm



Retractors
Hooklet, blunt, 1 prong

Material: Stainless steel

Other Sizes:
006-0075-01 : 16.5 cm

RETRACTORS



Retractors

Hooklet, blunt, 2 prongs

Material: Stainless steel

Other Sizes:

006-0075-02 : 16.5 cm



Retractors

Hooklet, blunt, 3 prongs

Material: Stainless steel

Other Sizes:

006-0075-03 : 16.5 cm



Retractors

Hooklet, blunt, 4 prongs

Material: Stainless steel

Other Sizes:

006-0075-04 : 16.5 cm



Retractors

Hooklet, flexible, sharp, 2 prongs

Material: Stainless steel

Other Sizes:

006-0078-02 : 16 cm



Retractors

Hooklet, flexible, sharp, 3 prongs

Material: Stainless steel

Other Sizes:

006-0078-03 : 16 cm



Retractors

Hooklet, flexible, blunt, 2 prongs

Material: Stainless steel

Other Sizes:

006-0079-02 : 16 cm

RETRACTORS



Retractors
Hooklet, flexible, blunt, 3 prongs

Material: Stainless steel

Other Sizes:
006-0079-03 : 16 cm



Retractors
Hooklet, delicate, sharp, 4 prongs

Material: Stainless steel

Other Sizes:
006-0086-04 : 16.5 cm



Retractors
Hooklet, delicate, blunt, 4 prongs

Material: Stainless steel

Other Sizes:
006-0087-04 : 16.5 cm



Retractors
Micro vascul hooklet, blunt

Material: Stainless steel

Other Sizes:
006-0088-12 : 12 cm



Retractors
Hooklet, acc. to Desmarres

Material: Stainless steel

Other Sizes:
006-0091-08 : 16 cm, 8mm
006-0091-10 : 16 cm, 10mm
006-0091-12 : 16 cm, 12mm
006-0091-14 : 16 cm, 14mm
006-0091-16 : 16 cm, 16mm
006-0091-18 : 16 cm, 18mm



Retractors
Hooklet, fenestrated

Material: Stainless steel

Other Sizes:
006-0093-12 : 16 cm, 12mm
006-0093-14 : 16 cm, 14mm
006-0093-16 : 16 cm, 16mm
006-0093-18 : 16 cm, 18mm

RETRACTORS



Retractors

Hooklet, acc. to Mini-Langenbeck, 16 cm

Material: Stainless steel

Other Sizes:

006-0095-10	10 x 6 mm
006-0095-17	17 x 5mm
006-0095-20	20 x 6 mm
006-0095-22	22 x 8 mm



Retractors

Retractor, blunt, 2 prongs,

Material: Stainless steel

Other Sizes:

006-0099-16	14 x 8 mm, 16 cm
-------------	------------------



Retractors

Retractor, delicated, sharp, 1 prong

Material: Stainless steel

Other Sizes:

006-0100-01	16.5 cm
-------------	---------



Retractors

Retractor, delicated, sharp, 2 prongs

Material: Stainless steel

Other Sizes:

006-0100-02	16.5 cm
-------------	---------



Retractors

Retractor, delicated, sharp, 3 prongs

Material: Stainless steel

Other Sizes:

006-0100-03	16.5 cm
-------------	---------



Retractors

Retractor, delicated, sharp, 4 prongs

Material: Stainless steel

Other Sizes:

006-0100-04	16.5 cm
-------------	---------

RETRACTORS



Retractors
Retractor, delicate, blunt, 1 prong

Material: Stainless steel

Other Sizes:
006-0101-01 : 16.5 cm



Retractors
Retractor, delicate, blunt, 2 prongs

Material: Stainless steel

Other Sizes:
006-0101-02 : 16.5 cm



Retractors
Retractor, delicate, blunt, 3 prongs

Material: Stainless steel

Other Sizes:
006-0101-03 : 16.5 cm



Retractors
Retractor, delicate, blunt, 4 prongs

Material: Stainless steel

Other Sizes:
006-0101-04 : 16.5 cm



Retractors
Hooklet, acc. to Meyerding

Material: Stainless steel

Other Sizes:
006-0151-01 : 18 x 7 mm, 17.5 cm



Retractors
Hooklet, acc. to Meyerding

Material: octagonal handle

Other Sizes:
006-0151-02 : 16 x 5 mm, 17.5 cm

RETRACTORS



Retractors
Hooklet, acc. to Meyerding

Material: Stainless steel

Other Sizes:
006-0151-03 : 7 x 4 mm, 17.5 cm



Retractors
Hooklet, acc. to Meyerding

Material: Stainless steel

Other Sizes:
006-0151-04 : 12 x 4 mm, 17.5 cm



Retractors
Hooklet, acc. to Meyerding

Material: Stainless steel

Other Sizes:
006-0151-05 : 8 x 4 mm, 17.5 cm



Retractors
Hooklet, acc. to Meyerding

Material: Stainless steel

Other Sizes:
006-0151-06 : 7 x 9 mm, 17.5 cm



Retractors
Hooklet, acc. to Senn-Green

Material: Stainless steel

Other Sizes:
006-0161-01 : 20 x 6 mm, 15 cm



Retractors
Hooklet, acc. to Senn-Green

Material: Stainless steel

Other Sizes:
006-0161-02 : 10 x 6 mm, 15 cm

RETRACTORS



Retractors
Hooklet, acc. to Ragnell-Davies, double

Material: Stainless steel

Other Sizes:
006-0164-14 : 15 cm



Retractors
Hooklet, acc. to Senn-Mueller, sharp

Material: Stainless steel

Other Sizes:
006-0166-16 : 16 cm



Retractors
Hooklet, acc. to Senn-Mueller, blunt

Material: Stainless steel

Other Sizes:
006-0167-16 : 16 cm



Retractors
Retractor, acc. to Cushing fenestrated

Material: Stainless steel

Other Sizes:
006-0170-20 : 20.5 cm



Retractors
Hooklet, acc. to Cushing

Material: Stainless steel

Other Sizes:
006-0171-08 : 8 mm, 20.5 cm
006-0171-10 : 10 mm, 20.5 cm
006-0171-12 : 12 mm, 20.5 cm
006-0171-14 : 14 mm, 20.5 cm
006-0171-16 : 16 mm, 20.5 cm
006-0171-18 : 18 mm, 20.5 cm



Retractors
Hooklet, acc. to Cushing

Material: Stainless steel

Other Sizes:
006-0172-08 : 8 mm, 24 cm
006-0172-10 : 10 mm, 24 cm
006-0172-12 : 12 mm, 24 cm
006-0172-14 : 14 mm, 24 cm
006-0172-16 : 16 mm, 24 cm
006-0172-18 : 18 mm, 24 cm

RETRACTORS



Retractors
Hooklet, malleable shaft

Material: Stainless steel

Other Sizes:

006-0174-08	8 mm, 24 cm
006-0174-11	11 mm, 24 cm
006-0174-15	15 mm, 24 cm
006-0174-17	17 mm, 24 cm
006-0174-20	20 mm, 24 cm
006-0174-23	23 mm, 24 cm
006-0174-04	4 mm, 24 cm
006-0174-06	6 mm, 24 cm



Retractors
Vein hooklet, acc. to Brom, small

Material: Stainless steel

Other Sizes:

006-0176-01	19.5 cm
-------------	---------



Retractors
Vein hooklet, acc. to Brom, large

Material: Stainless steel

Other Sizes:

006-0176-02	19.5 cm
-------------	---------



Retractors
Hooklet, acc. to Strandell-Stille, no. 1

Material: Stainless steel

Other Sizes:

006-0191-01	19 cm
-------------	-------



Retractors
Hooklet, acc. to Strandell-Stille, no. 2

Material: Stainless steel

Other Sizes:

006-0191-02	19 cm
-------------	-------



Retractors
Hooklet, acc. to Kaye-Millard,
2 prongs, sharp

Material: Stainless steel

Other Sizes:

006-0192-02	8 cm
-------------	------

RETRACTORS



Retractors

Retractor, acc. to Klapp, 2 prongs, blunt

Material: Stainless steel

Other Sizes:

006-0195-01 : 12 x 6 mm, 17.5 cm



Retractors

Retractor, acc. to Klapp, 3 prongs, blunt

Material: Stainless steel

Other Sizes:

006-0195-02 : 12 x 11 mm, 17.5 cm



Retractors

Retractor, acc. to Klapp, 4 prongs, blunt

Material: Stainless steel

Other Sizes:

006-0195-03 : 15x11 mm, 17.5 cm



Retractors

Hooklet, delicate, 4 prongs, sharp

Material: Stainless steel

Other Sizes:

006-0200-04 : 16.5 cm



Retractors

Hooklet, delicate, 4 prongs, blunt

Material: Stainless steel

Other Sizes:

006-0201-04 : 16.5 cm



Retractors

Retractor, acc. to Volkmann, sharp, 1 prong

Material: Stainless steel

Other Sizes:

006-0210-01 : 21.5 cm

RETRACTORS



Retractors
Retractor, acc. to Volkmann, sharp, 2 prongs

Material: Stainless steel

Other Sizes:
006-0210-02 : 21.5 cm



Retractors
Retractor, acc. to Volkmann, sharp, 3 prongs

Material: Stainless steel

Other Sizes:
006-0210-03 : 21.5 cm



Retractors
Retractor, acc. to Volkmann, sharp, 4 prongs

Material: Stainless steel

Other Sizes:
006-0210-04 : 21.5 cm



Retractors
Retractor, acc. to Volkmann, sharp, 6 prongs

Material: Stainless steel

Other Sizes:
006-0210-06 : 21.5 cm



Retractors
Retractor, acc. to Volkmann, blunt, 1 prong

Material: Stainless steel

Other Sizes:
006-0211-01 : 21.5 cm



Retractors
Retractor, acc. to Volkmann, blunt, 2 prongs

Material: Stainless steel

Other Sizes:
006-0211-02 : 21.5 cm

RETRACTORS



Retractors
Retractor, acc. to Volkmann, blunt, 3 prongs

Material: Stainless steel

Other Sizes:
006-0211-03 21.5 cm



Retractors
Retractor, acc. to Volkmann, blunt, 4 prongs

Material: Stainless steel

Other Sizes:
006-0211-04 21.5 cm



Retractors
Retractor, acc. to Volkmann, blunt, 6 prongs

Material: Stainless steel

Other Sizes:
006-0211-06 21.5 cm



Retractors
Retractor, acc. to Volkmann, sharp, 1 prong

Material: Stainless steel

Other Sizes:
006-0220-01 22 cm



Retractors
Retractor, acc. to Volkmann, sharp, 2 prongs

Material: Stainless steel

Other Sizes:
006-0220-02 22 cm



Retractors
Retractor, acc. to Volkmann, sharp, 3 prongs

Material: Stainless steel

Other Sizes:
006-0220-03 22 cm

RETRACTORS



Retractors
Retractor, acc. to Volkmann, sharp, 6 prongs

Material: Stainless steel

Other Sizes:
006-0220-06 : 22 cm



Retractors
Retractor, acc. to Volkmann, sharp, 4 prongs

Material: Stainless steel

Other Sizes:
006-220-04 : 22 cm



Retractors
Retractor, acc. to Volkmann, blunt, 1 prong

Material: Stainless steel

Other Sizes:
006-0221-01 : 22 cm



Retractors
Retractor, acc. to Volkmann, blunt, 2 prongs

Material: Stainless steel

Other Sizes:
006-0221-02 : 22 cm



Retractors
Retractor, acc. to Volkmann, blunt, 3 prongs

Material: Stainless steel

Other Sizes:
006-0221-03 : 22 cm



Retractors
Retractor, acc. to Volkmann, blunt, 4 prongs

Material: Stainless steel

Other Sizes:
006-0221-04 : 22 cm

RETRACTORS



Retractors

Retractor, acc. to Volkmann, blunt,
6 prongs

Material: Stainless steel

Other Sizes:

006-0221-06 22 cm



Retractors

Retractor, acc. to Volkmann, semi-
sharp, 1 prong

Material: Stainless steel

Other Sizes:

006-0222-01 22 cm



Retractors

Retractor, acc. to Volkmann, semi-
sharp, 2 prongs

Material: Stainless steel

Other Sizes:

006-0222-02 22 cm



Retractors

Retractor, acc. to Volkmann, semi-
sharp, 3 prongs

Material: Stainless steel

Other Sizes:

006-0222-03 22 cm



Retractors

Retractor, acc. to Volkmann, semi-sharp,
4 prongs

Material: Stainless steel

Other Sizes:

006-0222-04 22 cm



Retractors

Retractor, acc. to Volkmann, semi-sharp,
6 prongs

Material: Stainless steel

Other Sizes:

006-0222-06 22 cm

RETRACTORS



Retractors
Retractor, acc. to Volkmann, sharp, 1 prong

Material: Stainless steel

Other Sizes:
006-0230-01 21.5 cm



Retractors
Retractor, acc. to Volkmann, blunt, 1 prong

Material: Stainless steel

Other Sizes:
006-0231-01 21.5 cm



Retractors
Retractor, 1 prong, sharp

Material: Stainless steel

Other Sizes:
006-0232-01 21.5 cm



Retractors
Retractor, acc. to KoCher, sharp, 1 prong

Material: Stainless steel

Other Sizes:
006-0240-01 22 cm



Retractors
Retractor, acc. to KoCher, sharp, 2 prongs

Material: Stainless steel

Other Sizes:
006-0240-02 22 cm



Retractors
Retractor, acc. to KoCher, sharp, 3 prongs

Material: Stainless steel

Other Sizes:
006-0240-03 22 cm

RETRACTORS



Retractors

Retractor, acc. to KoCher, sharp, 4 prongs

Material: Stainless steel

Other Sizes:

006-0240-04 22 cm



Retractors

Retractor, acc. to KoCher, sharp, 6 prongs

Material: Stainless steel

Other Sizes:

006-0240-06 22 cm



Retractors

Retractor, acc. to KoCher, sharp, 8 prongs

Material: Stainless steel

Other Sizes:

006-0240-08 22 cm



Retractors

Retractor, acc. to KoCher, blunt, 1 prong

Material: Stainless steel

Other Sizes:

006-0241-01 22 cm



Retractors

Retractor, acc. to KoCher, blunt, 2 prongs

Material: Stainless steel

Other Sizes:

006-0241-02 22 cm



Retractors

Retractor, acc. to KoCher, blunt, 3 prongs

Material: Stainless steel

Other Sizes:

006-0241-03 22 cm

RETRACTORS



Retractors

Retractor, acc. to KoCher, blunt, 4 prongs

Material: Stainless steel

Other Sizes:

006-0241-04 : 22 cm



Retractors

Retractor, acc. to KoCher, blunt, 6 prongs

Material: Stainless steel

Other Sizes:

006-0241-06 : 22 cm



Retractors

Retractor, acc. to KoCher, blunt, 8 prongs

Material: Stainless steel

Other Sizes:

006-0241-08 : 22 cm



Retractors

Retractor, acc. to KoCher, semi-sharp, 1 prong

Material: Stainless steel

Other Sizes:

006-0242-01 : 22 cm



Retractors

Retractor, acc. to KoCher, semi-sharp, 2 prongs

Material: Stainless steel

Other Sizes:

006-0242-02 : 22 cm



Retractors

Retractor, acc. to KoCher, semi-sharp, 3 prongs

Material: Stainless steel

Other Sizes:

006-0242-03 : 22 cm

RETRACTORS



Retractors

Retractor, acc. to KoCher, semi-sharp
4 prongs

Material: Stainless steel

Other Sizes:

006-0242-04 : 22 cm



Retractors

Retractor, acc. to KoCher, semi-sharp,
6 prongs

Material: Stainless steel

Other Sizes:

006-0242-06 : 22 cm



Retractors

Retractor, acc. to KoCher, semi-sharp,
8 prongs

Material: Stainless steel

Other Sizes:

006-0242-08 : 22 cm



Retractors

Retractor, acc. to acc. to Martin, sharp,
2 prongs

Material: Stainless steel

Other Sizes:

006-0245-02 : 22.5 cm



Retractors

Retractor, acc. to acc. to Martin, sharp,
3 prongs

Material: Stainless steel

Other Sizes:

006-0245-03 : 22.5 cm



Retractors

Retractor, acc. to acc. to Martin, sharp,
4 prongs

Material: Stainless steel

Other Sizes:

006-0245-04 : 22.5 cm

RETRACTORS

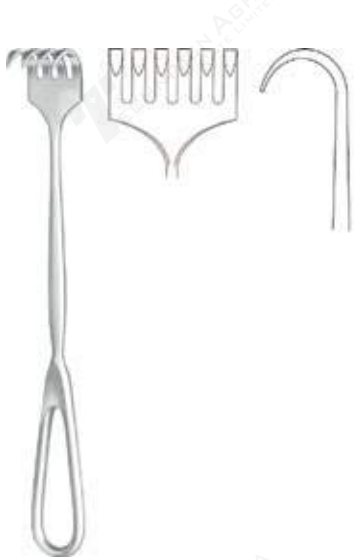

Retractors

Retractor, acc. to acc. to Martin, sharp, 6 prongs

Material: Stainless steel

Other Sizes:

006-0245-06 : 22.5 cm

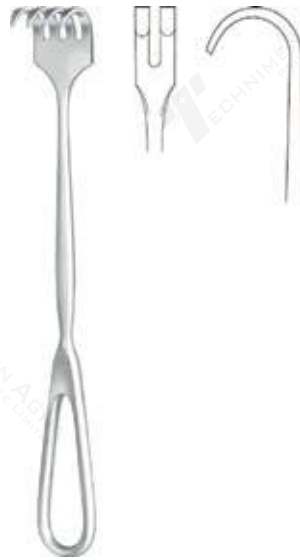

Retractors

Retractor, acc. to acc. to Martin, blunt, 2 prongs

Material: Stainless steel

Other Sizes:

006-0246-02 : 22.5 cm



Retractors

Retractor, acc. to acc. to Martin, blunt, 3 prongs

Material: Stainless steel

Other Sizes:

006-0246-03 : 22.5 cm

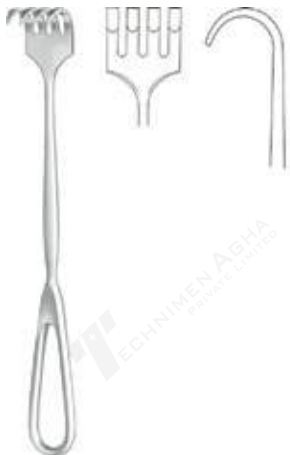

Retractors

Retractor, acc. to acc. to Martin, blunt, 4 prongs

Material: Stainless steel

Other Sizes:

006-0246-04 : 22.5 cm

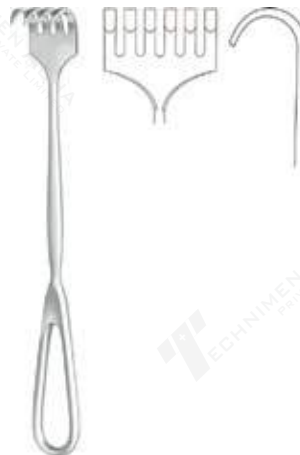

Retractors

Retractor, acc. to acc. to Martin, blunt, 6 prongs

Material: Stainless steel

Other Sizes:

006-0246-06 : 22.5 cm



Retractors

Retractor, acc. to Ollier, blunt, 37 x 30 mm

Material: Stainless steel

Other Sizes:

006-0251-03 : 23 cm

RETRACTORS



Retractors

Retractor, acc. to Ollier, blunt, 39 x 60 mm

Material: Stainless steel

Other Sizes:

006-0253-04 : 23 cm



Retractors

Retractor, acc. to Wassmund, 33 x 21 mm

Material: Stainless steel

Other Sizes:

006-0261-02 : 20.5 cm



Retractors

Retractor, acc. to Koerte, sharp, 8 prongs, 40 x 30 mm

Material: Stainless steel

Other Sizes:

006-0266-08 : 24.5 cm



Retractors

Retractor, acc. to Koerte, blunt, 8 prongs, 40 x 30 mm

Material: Stainless steel

Other Sizes:

006-0267-08 : 24.5 cm



Retractors

Retractor, acc. to Israel, blunt

Material: Stainless steel

Other Sizes:

006-0281-04 : 40 x 40 mm, 25.5 cm



Retractors

Retractor, acc. to Israel, blunt

Material: Stainless steel

Other Sizes:

006-0283-05 : 45 x 50 mm, 25.5 cm

RETRACTORS



Retractors

Retractor, acc. to Israel, blunt

Material: Stainless steel

Other Sizes:

006-0287-06 : 50 x 60 mm, 25.5 cm



Retractors

Retractor, acc. to Israel, blunt

Material: Stainless steel

Other Sizes:

006-0289-07 : 70 x 70 mm, 25.5 cm



Retractors

Retractor, acc. to Langenbeck

Material: Stainless steel

Other Sizes:

006-0291-01 : 30 x 11 mm, 22.5 cm
 006-0291-02 : 30 x 14 mm, 22.5 cm
 006-0291-03 : 30 x 16 mm, 22.5 cm
 006-0291-04 : 40 x 11 mm, 22.5 cm
 006-0291-05 : 50 x 11 mm, 22.5 cm



Retractors

Retractor, acc. to Langenbeck

Material: Stainless steel

Other Sizes:

006-0293-01 : 30 x 11 mm, 22.5 cm
 006-0293-02 : 30 x 14 mm, 22.5 cm
 006-0293-03 : 30 x 16 mm, 22.5 cm
 006-0293-04 : 40 x 11 mm, 22.5 cm
 006-0293-05 : 50 x 11 mm, 22.5 cm



Retractors

Retractor, acc. to Langenbeck

Material: Stainless steel

Other Sizes:

006-0295-21 : 65 x 20 mm, 21 cm



Retractors

Retractor, acc. to Langenbeck

Material: Stainless steel

Other Sizes:

006-0297-21 : 85 x 15 mm, 22.5 cm

RETRACTORS



Retractors

Retractor, acc. to Langenbeck, 43 x 13 mm

Material: Stainless steel

Other Sizes:

006-0299-01 : 21 cm



Retractors

Retractor, acc. to Langenbeck-Green

Material: Stainless steel

Other Sizes:

006-0301-16 : 6 x 16 mm, 16 cm
006-0301-25 : 6 x 25 mm, 16 cm



Retractors

Retractor, acc. to acc. to Lahey

Material: Stainless steel

Other Sizes:

006-0307-19 : 31 x 6 mm, 19.5 cm



Retractors

Retractor, acc. to Little

Material: Stainless steel

Other Sizes:

006-0313-20 : 13 x 15 mm, 20 cm



Retractors

Retractor, acc. to KoCher

Material: Stainless steel

Other Sizes:

006-0315-18 : 43 x 18 mm, 23 cm
006-0315-20 : 53 x 20 mm, 23 cm
006-0315-25 : 63 x 25 mm, 23 cm
006-0315-30 : 77 x 30 mm, 23 cm
006-0315-40 : 78 x 40 mm, 23 cm



Retractors

Retractor, acc. to KoCher-Langenbeck

Material: Stainless steel

Other Sizes:

006-0317-01 : 25 x 6 mm, 21.5 cm
006-0317-02 : 35 x 8 mm, 21.5 cm
006-0317-03 : 35 x 11 mm, 21.5 cm
006-0317-04 : 35 x 15 mm, 21.5 cm
006-0317-05 : 40 x 11 mm, 21.5 cm
006-0317-06 : 55 x 11 mm, 21.5 cm
006-0317-07 : 70 x 14 mm, 21.5 cm
006-0317-08 : 80 x 12 mm, 21.5 cm
006-0317-09 : 80 x 16 mm, 21.5 cm

RETRACTORS



Retractors

Retractor, acc. to KoCher-Langenbeck

Material: Stainless steel

Other Sizes:

006-0319-01	25 x 10 mm, 21.5 cm
006-0319-02	40 x 13 mm, 21.5 cm
006-0319-03	60 x 13 mm, 21.5 cm
006-0319-04	40 x 18 mm, 21.5 cm
006-0319-05	60 x 18 mm, 21.5 cm
006-0319-06	85 x 18 mm, 21.5 cm
006-0319-07	60 x 25 mm, 21.5 cm
006-0319-08	85 x 25 mm, 21.5 cm



Retractors

Retractor, acc. to Zenker, angled

Material: Stainless steel

Other Sizes:

006-0321-01	35 x 8 mm, 30.5 cm
006-0321-03	75 x 12 mm, 30.5 cm
006-0321-04	85 x 20 mm, 30.5 cm
006-0321-05	100 x 25 mm, 30.5 cm
006-0321-02	60 x 12 mm, 30.5 cm



Retractors

Retractor, acc. to KoCher

Material: Stainless steel

Other Sizes:

006-0325-01	22 x 12 mm, 21.5 cm
006-0325-02	24 x 14 mm, 21.5 cm

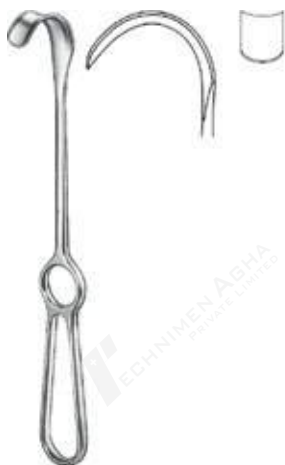

Retractors

Retractor, acc. to KoCher

Material: Stainless steel

Other Sizes:

006-0351-01	42 x 10 mm, 22 cm
006-0351-02	42 x 15 mm, 23 cm
006-0351-03	43 x 20 mm, 23 cm

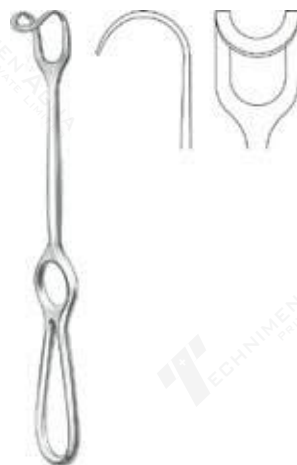

Retractors

Retractor, acc. to Middeldorpf

Material: Stainless steel

Other Sizes:

006-0361-01	18 x 17 mm, 21.5 cm
006-0361-02	25 x 22 mm, 23 cm
006-0361-03	18 x 17 mm, 24.5 cm



Retractors

Retractor, acc. to RiChardson-Eastman, no. 1

Material: steel 18/8 martinit, antimagnetic, stainless, acid-resistant

Other Sizes:

006-0381-01	26 cm
-------------	-------

RETRACTORS



Retractors

Retractor, acc. to Richardson-Eastman, no. 2

Material: steel 18/8 martinit, antimagnetic, stainless, acid-resistant

Other Sizes:
006-0381-02 : 27 cm



Retractors

Retractor, acc. to Richardson

Material: steel 18/8 martinit, antimagnetic, stainless, acid-resistant

Other Sizes:
006-0391-01 : 25 x 21 mm, 23.5 cm
006-0391-02 : 37 x 29 mm, 24 cm
006-0391-03 : 45 x 40 mm, 24 cm



Retractors

Retractor, acc. to Richardson

Material: steel 18/8 martinit, antimagnetic, stainless, acid-resistant

Other Sizes:
006-0395-24 : 53 x 22 mm, 24 cm



Retractors

Retractor, acc. to Kelly

Material: steel 18/8 martinit, antimagnetic, stainless, acid-resistant

Other Sizes:
006-0397-26 : 70 x 50 mm, 26 cm



Retractors

Retractor, acc. to acc. to Doyen-Stillé

Material: Stainless steel

Other Sizes:
006-0401-01 : 97 x 29 mm, 26 cm
006-0401-02 : 101 x 31 mm, 26 cm
006-0401-03 : 127 x 52 mm, 26 cm



Retractors

Retractor, acc. to Hoesel

Material: Stainless steel

Other Sizes:
006-0405-01 : 63 x 21 mm, 26 cm
006-0405-02 : 83 x 30 mm, 26 cm
006-0405-03 : 103 x 30 mm, 26 cm
006-0405-04 : 120 x 30 mm, 26 cm
006-0405-05 : 140 x 30 mm, 26 cm
006-0405-06 : 140 x 40 mm, 26 cm

RETRACTORS



Retractors

Retractor, acc. to Middeldorpf

Material: Stainless steel

Other Sizes:

006-0441-01 : 48 x 45 mm, 27 cm

Retractors

Retractor, acc. to Middeldorpf

Material: Stainless steel

Other Sizes:

006-0441-02 : 52 x 50 mm, 27 cm
006-0441-03 : 60 x 70 mm, 70 cm

Retractors

Retractor, acc. to Fritsch

Material: Stainless steel

Other Sizes:

006-0452-00 : 37 x 31 mm, 23.5 cm
006-0452-01 : 38 x 40 mm, 24 cm
006-0452-02 : 43 x 51 mm, 25 cm
006-0452-03 : 49 x 61 mm, 25 cm
006-0452-04 : 48 x 75 mm, 25.5 cm
006-0452-05 : 65 x 85 mm, 26.5 cm



Retractors

Retractor, abdominal, acc. to acc. to Doyen

Material: steel 18/8 martinit, antimagnetic, stainless, acid-resistant

Other Sizes:

006-0461-25 : 48 x 88 mm, 24 cm



Retractors

Retractor, acc. to KoCher

Material: Stainless steel

Other Sizes:

006-0469-22 : 73 x 25 mm, 24 cm



Retractors

Retractor, acc. to KoCher

Material: Stainless steel

Other Sizes:

006-0471-01 : 80 x 45 mm, 25 cm
006-0471-02 : 80 x 55 mm, 25 cm
006-0471-03 : 80 x 65 mm, 25 cm

RETRACTORS



Retractors

Retractor, acc. to Martin

Material: Stainless steel

Other Sizes:

006-0501-25 : 110 x 27 mm, 26 cm



Retractors

Retractor, acc. to acc. to Simon

Material: Stainless steel

Other Sizes:

006-0505-28 : 115 x 22 mm, 28 cm
006-0507-28 : 115 x 27 mm, 28 cm



Retractors

Retractor, acc. to Coryllos

Material: Stainless steel

Other Sizes:

006-0537-01 : 85 x 22 mm, 24 cm
006-0537-02 : 108 x 43 mm, 24 cm
006-0537-03 : 119 x 65 mm, 24 cm



Retractors

Scapula retractor

Material: Stainless steel

Other Sizes:

006-0545-01 : 80 x 54 mm, 19 cm



Retractors

Scapula retractor

Material: Stainless steel

Other Sizes:

006-0545-02 : 80 x 95 mm, 18.5 cm



Retractors

Retractor, acc. to SauerbruCh

Material: Stainless steel

Other Sizes:

006-0551-25 : 127 x 38 mm, 25.5 cm

RETRACTORS



Retractors

Retractor, acc. to acc. to Brunner, straight

Material: Stainless steel

Other Sizes:

006-0558-08	84 x 20 mm, 25.5 cm
006-0558-10	104 x 25 mm, 25.5 cm
006-0558-12	124 x 30 mm, 25.5 cm
006-0558-13	130 x 30 mm, 25.5 cm
006-0558-14	144 x 30 mm, 25.5 cm
006-0558-16	160 x 30 mm, 25.5 cm
006-0558-18	164 x 30 mm, 25.5 cm



Retractors

Retractor, acc. to acc. to Brunner, curved

Material: Stainless steel

Other Sizes:

006-0559-08	82 x 20 mm, 25.5 cm
006-0559-10	102 x 20 mm, 25.5 cm
006-0559-12	122 x 25 mm, 25.5 cm
006-0559-14	140 x 25 mm, 25.5 cm
006-0559-16	162 x 30 mm, 25.5 cm
006-0559-18	182 x 30 mm, 25.5 cm



Retractors

Retractor, acc. to SauerbruCh

Material: Stainless steel

Other Sizes:

006-0561-01	50 x 15 mm, 22.5 cm
006-0561-02	63 x 23 mm, 22.5 cm
006-0561-03	80 x 20 mm, 22.5 cm



Retractors

N/A

Material: Stainless steel

Other Sizes:

006-0562-01	19 cm, 15x15 mm
006-0562-02	19 cm, 15x23 mm



Retractors

aorta retractor, acc. to Ross, flexible shaft, no. 1

Material: Stainless steel

Other Sizes:

006-0563-01	25.5 cm
-------------	---------



Retractors

aorta retractor, acc. to Ross, flexible shaft, no. 2

Material: Stainless steel

Other Sizes:

006-0563-02	25.5 cm
-------------	---------

RETRACTORS



Retractors

aorta retractor, acc.to Ross, flexible shaft,
no. 3

Material: Stainless steel

Other Sizes:

006-0563-03 25.5 cm



Retractors

aorta retractor, acc.to Ross, flexible shaft,
no. 4

Material: Stainless steel

Other Sizes:

006-0563-04 25.5 cm



Retractors

aorta retractor, acc.to Ross, flexible shaft,
no. 5

Material: Stainless steel

Other Sizes:

006-0563-05 25.5 cm



Retractors

aorta retractor, acc.to Ross, flexible shaft,
no. 6

Material: Stainless steel

Other Sizes:

006-0563-06 25.5 cm



Retractors

aorta valve Retractor, acc.to Borowski

Material: Stainless steel

Other Sizes:

006-0564-03 20 x 25 mm, 27 cm
006-0564-04 24 x 27 mm, 27 cm
006-0564-05 28 x 20 mm, 27 cm
006-0564-06 28 x 29 mm, 27 cm



Retractors

Retractor, acc. to Polloson, tip 60 mm

Material: Stainless steel

Other Sizes:

006-0577-27 29 cm

RETRACTORS

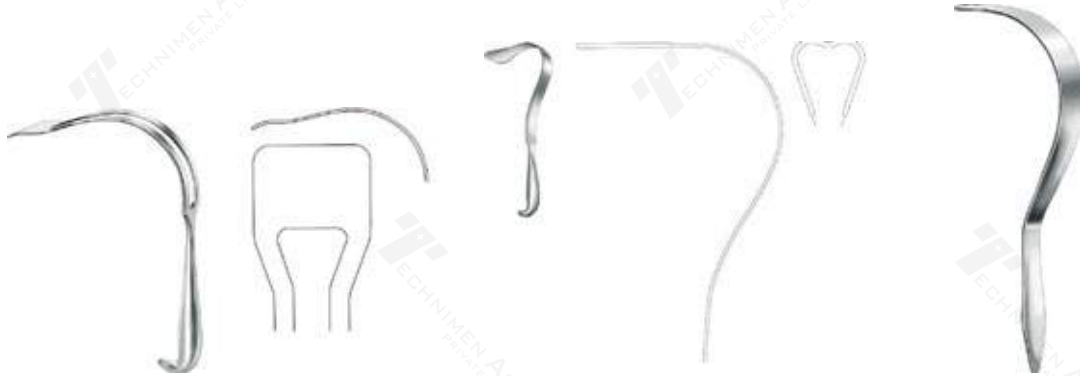

Retractors

Retractor, acc. to Polloson, fenestrated

Material: Stainless steel

Other Sizes:

006-0579-27 : 25.5 cm

Retractors

Retractor, acc. to Harrington

Material: Stainless steel

Other Sizes:

006-0581-01 : 137 x 44 mm, 31.5 cm
006-0581-02 : 137 x 65 mm, 33 cm

Retractors

Retractor, acc. to Deaver, 19 mm wide

Material: Stainless steel

Other Sizes:

006-0591-00 : 18 cm
006-0591-01 : 18 cm



Retractors

Retractor, acc. to Deaver, 22 mm wide

Material: Stainless steel

Other Sizes:

006-0591-02 : 21.5 cm

Retractors

Retractor, acc. to Deaver, 25 mm wide

Material: Stainless steel

Other Sizes:

006-0591-03 : 25 cm

Retractors

Retractor, acc. to Deaver, 25 mm wide

Material: Stainless steel

Other Sizes:

006-0591-04 : 31 cm

RETRACTORS



Retractors

Retractor, acc. to Deaver, 25 mm wide

Material: Stainless steel

Other Sizes:

006-0591-05 : 33 cm



Retractors

Retractor, acc. to Deaver, 25 mm wide

Material: Stainless steel

Other Sizes:

006-0591-06 : 36 cm



Retractors

Retractor, acc. to Deaver, 38 mm wide

Material: Stainless steel

Other Sizes:

006-0591-07 : 30 cm



Retractors

Retractor, acc. to Deaver, 50 mm wide

Material: Stainless steel

Other Sizes:

006-0591-08 : 31 cm



Retractors

Retractor, acc. to Deaver, 75 mm wide

Material: Stainless steel

Other Sizes:

006-0591-09 : 31.5 cm



Retractors

Retractor, acc. to Deaver-Grip

Material: Stainless steel

Other Sizes:

006-0592-04 : 25 mm, 31.5 cm
 006-0592-07 : 38 mm, 31.5 cm
 006-0592-08 : 50 mm, 31.5 cm
 006-0592-10 : 100 mm, 31.5 cm

RETRACTORS



Retractors
Atrium Retractor, right

Material: steel 18/8 martinit, antimagnetic, stainless, acid-resistant

Other Sizes:
006-0593-01 : 48 x 48 mm, 25 cm



Retractors
Atrium Retractor, serrated

Material: steel 18/8 martinit, antimagnetic, stainless, acid-resistant

Other Sizes:
006-0593-02 : 48 x 48 mm, 25 cm



Retractors
Atrium Retractor, left

Material: steel 18/8 martinit, antimagnetic, stainless, acid-resistant

Other Sizes:
006-0593-03 : 30 x 48 mm, 27 cm



Retractors
Retractor, acc. to Milkulicz

Material: Stainless steel

Other Sizes:
006-0603-01 : 90 x 35 mm, 25 cm
006-0603-02 : 125 x 50 mm, 25 cm
006-0603-03 : 160 x 50 mm, 25 cm



Retractors
Retractor, acc. to Milkulicz

Material: Stainless steel

Other Sizes:
006-0607-26 : 90 x 55 mm, 26 cm



Retractors
Retractor, acc. to Kelly

Material: Stainless steel

Other Sizes:
006-0611-01 : 205 x 38 mm, 27.5 cm

RETRACTORS



Retractors

Retractor, acc. to Kelly

Material: Stainless steel

Other Sizes:

006-0611-02 : 205 x 57 mm, 27.5 cm

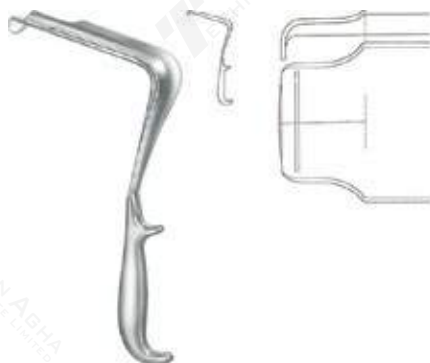

Retractors

Pelvis Retractor

Material: steel 18/8 martinit, antimagnetic, stainless, acid-resistant

Other Sizes:

006-0615-01 : 42 x 60 mm, 29 cm



Retractors

Pelvis Retractor

Material: steel 18/8 martinit, antimagnetic, stainless, acid-resistant

Other Sizes:

006-0615-02 : 193 x 60 mm, 29 cm

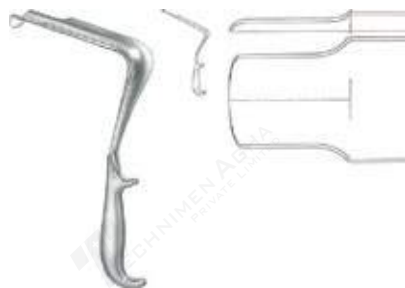

Retractors

Pelvis Retractor

Material: steel 18/8 martinit, antimagnetic, stainless, acid-resistant

Other Sizes:

006-0615-03 : 195 x 60 mm, 33 cm



Retractors

Retractor, acc. to Kuemmel

Material: Stainless steel

Other Sizes:

006-0621-28 : 100 x 45 mm, 31 cm



Retractors

Retractor, acc. to Kader, 20 mm wide

Material: Stainless steel

Other Sizes:

006-0623-20 : 28 cm

RETRACTORS



Retractors

Retractor, acc. to Kader, 30 mm wide

Material: Stainless steel

Other Sizes:

006-0623-30 28 cm

Retractors

Retractor, acc. to Kader, 40 mm wide

Material: Stainless steel

Other Sizes:

006-0623-40 28 cm



Retractors

Retractor, acc. to Collin-Hartmann

Material: steel 18/8 martinit, antimagnetic, stainless, acid-resistant

Other Sizes:

006-0652-01 35 x 29 mm, 15 cm



Retractors

Retractor, acc. to Roux , set, no. 1-3

Material: steel 18/8 martinit, antimagnetic, stainless, acid-resistant

Other Sizes:

006-0655-00 17 cm
 006-0655-01 14 cm
 006-0655-02 15 cm
 006-0655-03 17 cm



Retractors

Retractor, double, acc. to Farabeuf, set

Material: Stainless steel

Other Sizes:

006-0663-00 11.5 cm



Retractors

Retractor, double, acc. to Farabeuf, set

Material: Stainless steel

Other Sizes:

006-0665-00 15 cm

RETRACTORS



Retractors
Retractor, double, acc. to Mini-Roux

Material: Stainless steel

Other Sizes:
006-0667-06 : 8 x 6 mm, 14.5 cm



Retractors
Retractor, double, acc. to Baby-Roux

Material: Stainless steel

Other Sizes:
006-0669-13 : 12.5 cm



Retractors
Retractor, double, acc. to Parker, small set

Material: Stainless steel

Other Sizes:
006-0673-01 : 13.5 cm



Retractors
Retractor, double, acc. to Parker, large set

Material: Stainless steel

Other Sizes:
006-0673-02 : 17.5 cm



Retractors
Retractor, double, acc. to Parker-Mott, set

Material: Stainless steel

Other Sizes:
006-0675-00 : 16 cm



Retractors
Retractor, double, acc. to Mathieu, set

Material: Stainless steel

Other Sizes:
006-0683-00 : 20 cm

RETRACTORS



Retractors

Retractor, double, acc. to Parker-Langenbeck, set

Material: Stainless steel

Other Sizes:
006-0687-00 : 21.5 cm



Retractors

Retractor, double, acc. to Golet

Material: Stainless steel

Other Sizes:
006-0695-00 : 19 cm



Retractors

Woundspreader, sharp, 2 x 3 teeth

Material: Stainless steel

Other Sizes:
006-0700-05 : 5 cm



Retractors

Woundspreader, blunt, 2 x 3 teeth

Material: Stainless steel

Other Sizes:
006-0701-05 : 5 cm



Retractors

Woundspreader, sharp, 3 x 4 teeth

Material: Stainless steel

Other Sizes:
006-0702-07 : 7 cm



Retractors

Woundspreader, blunt, 3 x 4 teeth

Material: Stainless steel

Other Sizes:
006-0703-07 : 7 cm

RETRACTORS



Retractors
Woundspreader, sharp, 3 x 4 teeth

Material: Stainless steel

Other Sizes:
006-0704-07 : 7 cm



Retractors
Woundspreader, blunt, 3 x 4 teeth

Material: Stainless steel

Other Sizes:
006-0705-07 : 7 cm



Retractors
Woundspreader, acc. to Logan, sharp, 3 x 3 teeth

Material: Stainless steel

Other Sizes:
006-0708-04 : 4 cm



Retractors
N/A

Material: Stainless steel

Other Sizes:
006-0709-30 : 3 cm



Retractors
N/A

Material: Stainless steel

Other Sizes:
006-0709-40 : 4 cm

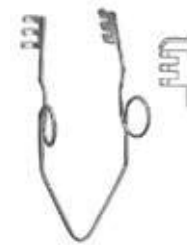

Retractors
N/A

Material: Stainless steel

Other Sizes:
006-0709-55 : 5.5 cm

RETRACTORS

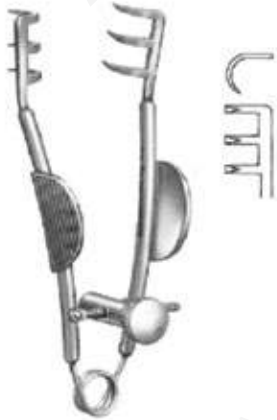

Retractors

N/A

Material: Stainless steel

Other Sizes:

006-0710-06 : 6 cm



Retractors

Woundspreader, acc. to Alm, sharp,
4 x 4 teeth

Material: Stainless steel

Other Sizes:

006-0714-07 : 7 cm
006-0714-10 : 10 cm



Retractors

Woundspreader, acc. to Alm, blunt,
4 x 4 teeth

Material: Stainless steel

Other Sizes:

006-0715-07 : 7 cm
006-0715-10 : 10 cm



Retractors

Woundspreader, blunt, 4 x 4 teeth

Material: Stainless steel

Other Sizes:

006-0717-10 : 10 cm



Retractors

Spreader, acc. to Jansen, blunt, 3 x 3 teeth

Material: Stainless steel

Other Sizes:

006-0723-10 : 10 cm
006-0723-20 : 10



Retractors

Woundspreader, sharp, 3 x 4 teeth

Material: Stainless steel

Other Sizes:

006-0725-14 : 13.5 cm

RETRACTORS



Retractors
Woundspreader, blunt, 3 x 4 teeth

Material: Stainless steel

Other Sizes:
006-0727-14 13.5 cm



Retractors
Spreader, acc. to Adson-Anderson,
4 x 4 teeth

Material: Stainless steel

Other Sizes:
006-0732-20 20 cm



Retractors
Woundspreader, acc. to Travers, blunt

Material: Stainless steel

Other Sizes:
006-0733-21 21.5 cm

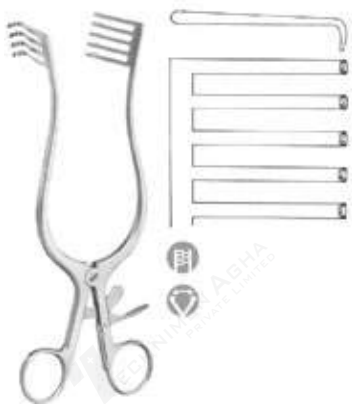

Retractors
Spreader, acc. to Norfolk/Norwich, blunt

Material: Stainless steel

Other Sizes:
006-0733-22 22 cm



Retractors
Woundspreader, sharp, 3 x 4 teeth

Material: Stainless steel

Other Sizes:
006-0734-20 20 cm
006-0734-24 24 cm
006-0734-26 24.5 cm



Retractors
Woundspreader, semi-sharp, 3 x 4 teeth

Material: Stainless steel

Other Sizes:
006-0734-21 20 cm
006-0736-24 24 cm

RETRACTORS



Retractors

Woundspreader, blunt, 3 x 4 teeth

Material: Stainless steel

Other Sizes:

006-0735-20	20 cm
006-0735-24	24 cm
006-0735-26	25.5 cm

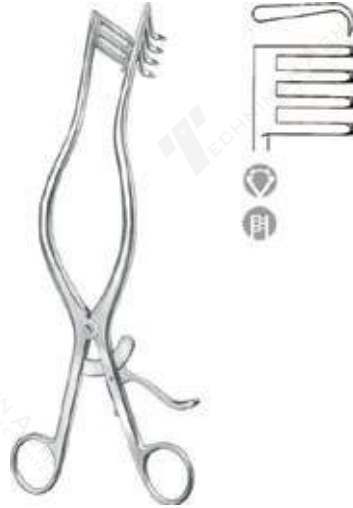

Retractors

Spreader, acc. to Adson, sharp, 3 x 4 teeth

Material: Stainless steel

Other Sizes:

006-0736-26	26 cm
006-0736-27	26 cm

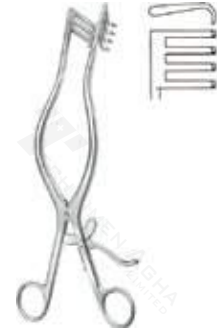

Retractors

Spreader, acc. to Adson, blunt, 3 x 4 teeth

Material: Stainless steel

Other Sizes:

006-0737-26	26 cm
-------------	-------

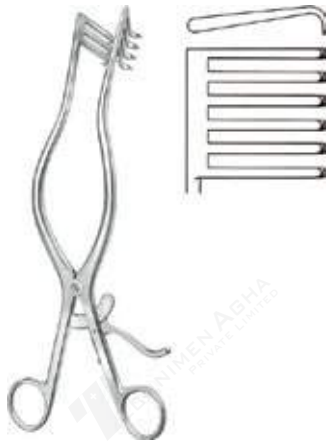

Retractors

Spreader, acc. to Adson, sharp, 6 x 6 teeth

Material: Stainless steel

Other Sizes:

006-0738-25	29 cm
006-0738-26	29 cm

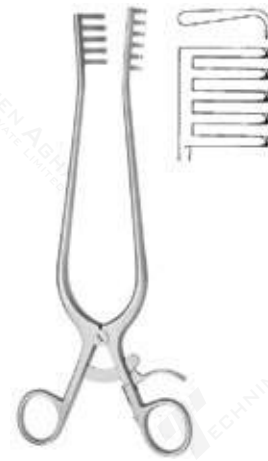

Retractors

Spreader, acc. to Adson, semi-sharp, 5 x 6 teeth

Material: Stainless steel

Other Sizes:

006-0738-27	25.5 cm
-------------	---------

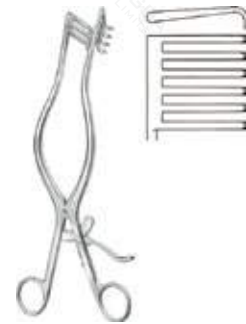

Retractors

Spreader, acc. to Adson, blunt, 6 x 6 teeth

Material: Stainless steel

Other Sizes:

006-0739-26	29 cm
-------------	-------

RETRACTORS



Retractors
Spreader, sharp, 3 x 4 teeth, 20 mm

Material: Stainless steel

Other Sizes:
006-0740-13 : 13 cm

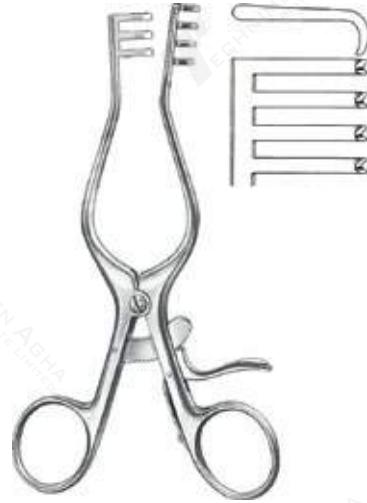

Retractors
Spreader, blunt, 3 x 4 teeth, 20 mm

Material: Stainless steel

Other Sizes:
006-0741-13 : 13 cm

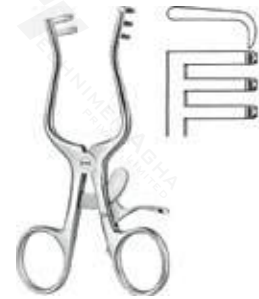

Retractors
Woundspreader, semi-sharp, 2 x 3 teeth

Material: Stainless steel

Other Sizes:
006-0747-10 : 11 cm



Retractors
Woundspreader, sharp, 2 x 3 teeth

Material: Stainless steel

Other Sizes:
006-0748-10 : 11 cm



Retractors
Woundspreader, blunt, 2 x 3 teeth

Material: Stainless steel

Other Sizes:
006-0749-10 : 11 cm

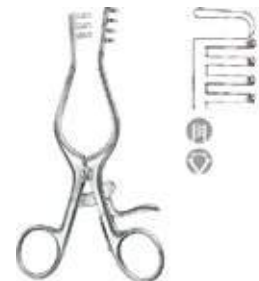

Retractors
Woundspreader, sharp, 3 x 4 teeth

Material: Stainless steel

Other Sizes:
006-0750-13 : 13.5 cm
006-0750-16 : 16 cm

RETRACTORS

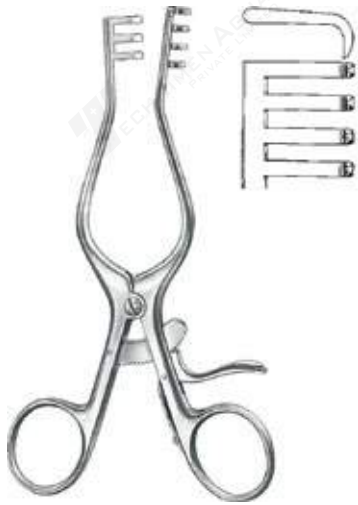

Retractors

Woundspreader, semi-sharp, 3 x 4 teeth

Material: Stainless steel

Other Sizes:

006-0750-14	13.5 cm
006-0750-17	16 cm



Retractors

Woundspreader, blunt, 3 x 4 teeth

Material: Stainless steel

Other Sizes:

006-0751-13	13.5 cm
006-0751-16	16 cm



Retractors

Spreader, acc. to Weitacc.
to Laner-Wullstein, sharp, 3 x 3 teeth

Material: Stainless steel

Other Sizes:

006-0752-13	13 cm
-------------	-------



Retractors

Spreader, acc. to Weitacc.
to Laner-Wullstein, blunt, 3 x 3 teeth

Material: Stainless steel

Other Sizes:

006-0753-13	13 cm
-------------	-------



Retractors

Spreader, acc. to Mollison, sharp, 4 x 4 teeth

Material: Stainless steel

Other Sizes:

006-0754-15	15.5 cm
-------------	---------



Retractors

Spreader, acc. to Plester, blunt, 2 x 2 teeth

Material: Stainless steel

Other Sizes:

006-0755-13	13 cm
-------------	-------

RETRACTORS



Retractors
Spreader, acc. to Plester, sharp, 2 x 2 teeth

Material: Stainless steel

Other Sizes:
006-0756-13 : 13 cm



Retractors
Spreader, acc. to Plester, blunt, left

Material: Stainless steel

Other Sizes:
006-0757-11 : 10.5 cm



Retractors
Spreader, acc. to Plester, blunt, right

Material: Stainless steel

Other Sizes:
006-0759-11 : 10.5 cm



Retractors
Spreader, acc. to William, right

Material: Stainless steel

Other Sizes:
006-0761-05 : 1 x 5 cm
006-0761-06 : 1 x 6 cm
006-0761-07 : 1 x 7 cm



Retractors
Spreader, acc. to William, left

Material: Stainless steel

Other Sizes:
006-0762-05 : 1 x 5 cm
006-0762-06 : 1 x 6 cm
006-0762-07 : 1 x 7 cm

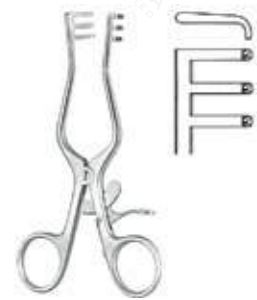

Retractors
Woundspreader, blunt, 3 x 3 teeth

Material: Stainless steel

Other Sizes:
006-0765-13 : 13.5 cm

RETRACTORS

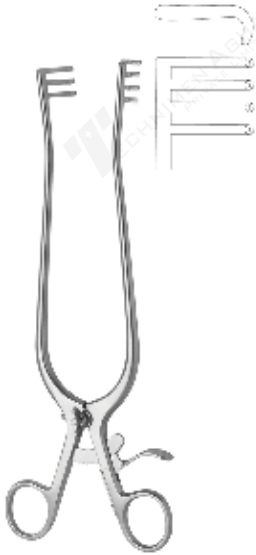

Retractors

Spreader, acc. to Hartmann, 3 x 4 teeth, blunt

Material: Stainless steel

Other Sizes: 006-0767-00 25 cm



Retractors

Center blade for 006-0767-00

Material: Stainless steel

Other Sizes: 006-0767-01 N/A



Retractors

Woundspreader, full blade

Material: Stainless steel

Other Sizes: 006-0767-13 13.5 cm



Retractors

Spreader, acc. to Henley, blunt, 3 x 4 teeth

Material: Stainless steel

Other Sizes: 006-0768-00 16 cm



Retractors

Center Blade for 15-768-00-07, 19 x 17 mm

Material: Stainless steel

Other Sizes: 006-0768-19 16 cm



Retractors

Center Blade for 15-768-00-07, 25 x 17 mm

Material: Stainless steel

Other Sizes: 006-0768-25 16 cm

RETRACTORS



Retractors

Center Blade for 15-768-00-07,
32 x 17 mm

Material: Stainless steel

Other Sizes:

006-0768-32 : 16 cm



Retractors

Spreader, acc. to Henley, sharp,
3 x 4 teeth

Material: Stainless steel

Other Sizes:

006-0769-00 : 16 cm



Retractors

Spreader, acc. to Adson, sharp,
3 x 4 teeth

Material: Stainless steel

Other Sizes:

006-0770-13 : 13.5 cm
006-0770-16 : 16.5 cm
006-0770-20 : 21 cm
006-0770-26 : 24.5 cm



Retractors

Spreader, acc. to Adson, blunt,
3 x 4 teeth

Material: Stainless steel

Other Sizes:

006-0771-13 : 13.5 cm
006-0771-16 : 16.5 cm
006-0771-20 : 21 cm
006-0771-26 : 24.5 cm



Retractors

Spreader, acc. to Adson, semi-sharp,
3 x 4 teeth

Material: Stainless steel

Other Sizes:

006-0772-13 : 14 cm
006-0772-16 : 16.5 cm
006-0772-20 : 21 cm
006-0772-26 : 24.5 cm



Retractors

Spreader, acc. to Adson, blunt,
3 x 4 teeth

Material: Stainless steel

Other Sizes:

006-0773-13 : 14 cm

RETRACTORS



Retractors
Spreader, acc. to Cloward, complete

Material: Stainless steel

Other Sizes:
006-0774-00 : 25 cm



Retractors
Spreader, acc. to Cloward, only, for 006-0774-00

Material: Stainless steel

Other Sizes:
006-0774-25 : 25 cm



Retractors
Blade for spreader, acc. to Cloward, fenestrated

Material: Stainless steel

Other Sizes:
006-0774-40 : 40 mm
006-0774-45 : 45 mm
006-0774-50 : 50 mm
006-0774-55 : 55 mm
006-0774-60 : 60 mm



Retractors
Spreader, acc. to Cloward, complete

Material: Stainless steel

Other Sizes:
006-0775-00 : 15 cm



Retractors
Spreader, acc. to Cloward, only, for 006-0775-00

Material: Stainless steel

Other Sizes:
006-0775-15 : 15 cm



Retractors
Blade for Spreader, acc. to Cloward, smooth

Material: Stainless steel

Other Sizes:
006-0775-40 : 40 mm
006-0775-45 : 45 mm
006-0775-50 : 50 mm
006-0775-55 : 55 mm
006-0775-60 : 60 mm

RETRACTORS



Retractors
Spreader, acc. to Beckmann, sharp,
4 x 4 teeth

Material: Stainless steel

Other Sizes:
006-0776-31 32 cm
006-0776-32 31.5 cm



Retractors
Spreader, acc. to Adson, blunt,
4 x 5 teeth

Material: Stainless steel

Other Sizes:
006-0777-32 33 cm



Retractors
Spreader, acc. to Adson, semi-sharp,
4 x 5 teeth

Material: Stainless steel

Other Sizes:
006-0777-33 33 cm



Retractors
Woundspreader, blunt, 4 x 4 teeth

Material: Stainless steel

Other Sizes:
006-0778-00 30.5 cm



Retractors
Woundspreader, sharp, 4 x 4 teeth

Material: Stainless steel

Other Sizes:
006-0778-01 30.5 cm



Retractors
Woundspreader, blunt, 4 x 4 teeth

Material: Stainless steel

Other Sizes:
006-0778-02 30.5 cm

RETRACTORS



Retractors

Woundspreader, sharp, 4 x 4 teeth

Material: Stainless steel

Other Sizes:

006-0778-03 : 30.5 cm



Retractors

Spreader, acc. to Beckmann-Eaton,
7 x 7 teeth

Material: Stainless steel

Other Sizes:

006-0778-32 : 32 cm



Retractors

Woundspreader, 6 x 6 teeth, sharp, right

Material: Stainless steel

Other Sizes:

006-0790-01 : 28.5 cm



Retractors

Woundspreader, 6 x 6 teeth, sharp, left

Material: Stainless steel

Other Sizes:

006-0790-02 : 28.5 cm



Retractors

Spreader, acc. to Vickers, low-profile

Material: steel 18/8 martinit,
antimagnetic, stainless, acid-resistant

Other Sizes:

006-0792-00 : 6 cm

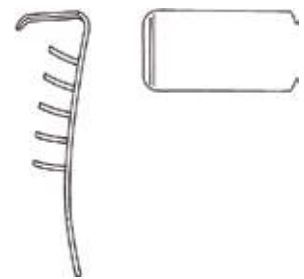

Retractors

Blade for spreader, acc. to Vickers

Material: steel 18/8 martinit,
antimagnetic, stainless, acid-resistant

Other Sizes:

006-0792-01 : 10 x 18 mm
006-0792-02 : 10 x 12 mm

RETRACTORS



Retractors
Spreader, low-profile, 3 x 3 teeth

Material: steel 18/8 martinit,
antimagnetic, stainless, acid-resistant

Other Sizes:
006-0793-00 : 9 cm



Retractors
Spreader, low-profile, full blunt

Material: steel 18/8 martinit,
antimagnetic, stainless, acid-resistant

Other Sizes:
006-0794-00 : 7.5 cm



Retractors
Finger woundspreader, acc. to Vickers

Material: steel 18/8 martinit,
antimagnetic, stainless, acid-resistant

Other Sizes:
006-0798-01 : 5 cm



Retractors
Woundspreader, acc. to Joll, sharp

Material: Stainless steel

Other Sizes:
006-0801-00 : 15.5 cm



Retractors
Woundspreader, acc. to Gelpi, 1 x 1 teeth

Material: Stainless steel

Other Sizes:
006-0802-13 : 13 cm



Retractors
Woundspreader, acc. to Gelpi, 1 x 1 teeth

Material: Stainless steel

Other Sizes:
006-0802-18 : 18 cm

RETRACTORS



Retractors

Woundspreader, acc. to Gelpi, 1 x 1 teeth

Material: Stainless steel

Other Sizes:

006-0804-18 : 18.5 cm



Retractors

Abdominal retractor, acc. to Collin-Baby

Material: Stainless steel

Other Sizes:

006-0820-00 : 18 cm



Retractors

Abdominal retractor, acc. to Collin

Material: Stainless steel

Other Sizes:

006-0822-22 : 20 cm



Retractors

Abdominal retractor, acc. to Collin

Material: Stainless steel

Other Sizes:

006-0823-00 : 22.5 cm
006-0824-00 : 22.5 cm



Retractors

Abdominal retractor, acc. to Collin

Material: Stainless steel

Other Sizes:

006-0826-00 : 31 cm



Retractors

Abdominal retractor, acc. to Ricard, complete

Material: Stainless steel

Other Sizes:

006-0828-00 : 28 cm

RETRACTORS



Retractors

Frame, only, for retractor, acc. to Ricard

Material: Stainless steel

Other Sizes:

006-0828-01 19 cm



Retractors

Abdominal retractor, acc. to Ricard, complete, large blades

Material: Stainless steel

Other Sizes:

006-0830-00 30 cm



Retractors

Center blade

Material: Stainless steel

Other Sizes:

006-0830-02 55 x 70 mm
006-0830-04 80 x 90 mm



Retractors

Changeable blade, 1 piece

Material: Stainless steel

Other Sizes:

006-0839-18 18 x 40 mm
006-0839-27 27 x 40 mm
006-0839-38 38 x 60 mm
006-0839-40 40 x 80 mm
006-0839-45 45 x 80 mm
006-0839-60 60 x 80 mm

Retractors

Changeable blade, 1 piece

Material: Stainless steel

Other Sizes:

006-0839-50 50 x 70 mm
006-0839-52 52 x 110 mm
006-0839-90 50 x 58 mm
006-0839-92 60 x 80 mm

Retractors

Changeable blade, 1 piece

Material: Stainless steel

Other Sizes:

006-0839-70 70 x 55 mm
006-0839-80 75 x 90 mm
006-0839-94 72 x 85 mm

RETRACTORS



Retractors

Abdominal retractor, acc. to Gosset

Material: Stainless steel

Other Sizes:

006-0840-00 : 12.5 cm

Retractors

Abdominal retractor, acc. to Gosset

Material: Stainless steel

Other Sizes:

006-0844-00 : 16.5 cm

Retractors

Abdominal retractor, acc. to Gosset

Material: Stainless steel

Other Sizes:

006-0846-00 : 18.5 cm



Retractors

Abdominal Retractor, acc. to Balfour-Baby

Material: Stainless steel

Other Sizes:

006-0850-00 : 12.5 cm

Retractors

Abdominal Retractor, acc. to Balfour,
wire blades

Material: Stainless steel

Other Sizes:

006-0852-00 : 20 cm

Retractors

Abdominal Retractor, acc. to Balfour,
full blades

Material: Stainless steel

Other Sizes:

006-0854-00 : 20 cm

RETRACTORS



Retractors

Center Blade, 100 x 70 mm, for 006-0856-00

Material: Stainless steel

Other Sizes:

006-0856-90 N/A



Retractors

Center Blade, for 006-0856-00

Material: Stainless steel

Other Sizes:

006-0856-91 100 x 60 mm



Retractors

Abdominal Retractor, acc. to Balfour, wire blades

Material: Stainless steel

Other Sizes:

006-0858-00 N/A



Retractors

Center Blade, acc. to Balfour

Material: Stainless steel

Other Sizes:

006-0859-01 45 x 80 mm
006-0859-02 68 x 85 mm



Retractors

Center Blade, acc. to Balfour

Material: Stainless steel

Other Sizes:

006-0859-06 40 x 68 mm
006-0859-05 68 x 85 mm



Retractors

Abdominal Retractor, acc. to Balfour, US-type

Material: Stainless steel

Other Sizes:

006-0860-00 ...

RETRACTORS



Retractors

Wire blades, acc. to Balfour, pair

Material: Stainless steel

Other Sizes:

006-0860-06	60 mm deep
006-0860-08	80 mm deep



Retractors

Abdominal retractor, acc. to O'Sullivan-O'Connor

Material: Stainless steel

Other Sizes:

006-0868-00	...
-------------	-----



Retractors

Abdominal retractor, acc. to KirsChner, oval, complete

Material: Stainless steel

Other Sizes:

006-0882-00	...
-------------	-----



Retractors

Frame, acc. to KirsChner, oval

Material: Stainless steel

Other Sizes:

006-0882-30	300 x 240 mm
-------------	--------------



Retractors

Abdominal retractor, acc. to KirsChner, angled, complete

Material: Stainless steel

Other Sizes:

006-0884-00	...
-------------	-----



Retractors

Frame, acc. to KirsChner, angled

Material: Stainless steel

Other Sizes:

006-0884-24	240 x 240 mm
-------------	--------------

RETRACTORS

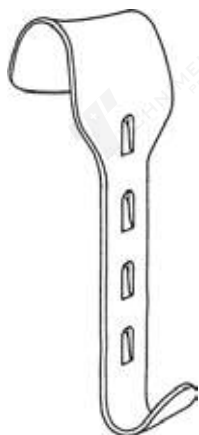

Retractors

Hook on blade, acc. to KirsChner

Material: Stainless steel

Other Sizes:

006-0889-40	40 x 55 mm
006-0889-50	50 x 65 mm
006-0889-60	60 x 85 mm
006-0889-78	78 x 65 mm
006-0889-80	80 x 90 mm



Retractors

Hook on blade, acc. to KirsChner

Material: Stainless steel

Other Sizes:

006-0889-98	98 x 50 mm
006-0889-99	105 x 35 mm



Retractors

Laminectomy retractor frame, acc. to Scoville

Material: Stainless steel

Other Sizes:

006-0906-00	150 mm
-------------	--------



Retractors

Hook blade, acc. to Scoville, blunt

Material: Stainless steel

Other Sizes:

006-0906-01	50 mm
006-0906-02	70 mm



Retractors

Hook blade, acc. to Scoville, sharp

Material: Stainless steel

Other Sizes:

006-0906-06	50 mm
006-0906-07	70 mm



Retractors

Blade, acc. to Scoville, serrated

Material: Stainless steel

Other Sizes:

006-0906-11	60 x 25 mm
006-0906-12	64 x 50 mm
006-0906-13	88 x 25 mm

RETRACTORS



Retractors

Hook blade, acc. to Taylor, 4 prongs

Material: Stainless steel

Other Sizes:

006-0906-41	48 x 50 mm
006-0906-42	64 x 50 mm
006-0906-43	64 x 64 mm
006-0906-44	80 x 57 mm



Retractors

Hook blade, acc. to Scoville, 4 prongs

Material: Stainless steel

Other Sizes:

006-0906-46	41 x 38 mm
006-0906-47	67 x 44 mm



Retractors

aminectomy retractor frame, acc. to Scoville-Haverfield

Material: Stainless steel

Other Sizes:

006-0906-50	150 mm
-------------	--------



Retractors

Martin-Arm-System '99

Material: Stainless steel

Other Sizes:

006-0910-01	N/A
-------------	-----



Retractors

Optic Holder, Ø 5 and 10 mm, for 006-0910-01

Material: all other, not specially marked material types

Other Sizes:

006-0910-10	N/A
-------------	-----



Retractors

Universal-Fixation for 006-0910-01

Material: Stainless steel

Other Sizes:

006-0910-50	N/A
-------------	-----

RETRACTORS



Retractors
Martin RoChard system, complete

Material: Stainless steel

Other Sizes:
006-0917-00 : N/A



Retractors
Lateral holding arm for 006-0917-00

Material: Stainless steel

Other Sizes:
006-0917-01 : N/A



Retractors
Cross rod, hexagon for 006-0917-00

Material: Stainless steel

Other Sizes:
006-0917-02 : N/A



Retractors
Slideable fixation for cross rod

Material: Stainless steel

Other Sizes:
006-0917-03 : N/A



Retractors
Fixation for RoChard retractors

Material: Stainless steel

Other Sizes:
006-0917-04 : 18.5 cm



Retractors
Retractor, acc. to RoChard,

Material: Stainless steel

Other Sizes:
006-0917-10 : 50 x 105 mm
006-0917-12 : 50 x 120 mm
006-0917-15 : 50 x 160 mm

RETRACTORS



Retractors
Abdominal spatula, malleable, 33 cm

Material: Stainless steel

Other Sizes:

006-0963-01	30 mm
006-0963-02	40 mm
006-0963-03	50 mm



Retractors
Abdominal spatula, acc. to Haberer

Material: Stainless steel

Other Sizes:

006-0971-00	17-25 mm, 20 cm
006-0971-01	25-30 mm, 28 cm
006-0971-02	37-45 mm, 30 cm



Retractors
Spatula, acc. to Martin, malleable, 20 cm

Material: Stainless steel

Other Sizes:

006-0975-06	6.5 mm
006-0975-09	9.5 mm
006-0975-13	13 mm
006-0975-16	16 mm
006-0975-19	19 mm
006-0975-25	25 mm



Retractors
Blade only for 006-0823-00

Material: Stainless steel

Other Sizes:

015-0839-38	38 x 55 mm
-------------	------------



Retractors
Center Blade, for 006-0824-00

Material: Replacement part

Other Sizes:

015-0839-45	50 x 75 mm
-------------	------------



Retractors
Center blade, for 006-0826-00

Material: Replacement part

Other Sizes:

015-0839-60	60 x 80 mm
-------------	------------

PROBES APPLICATORS

SPATULLAS

— RANGE



[DISCOVER NOW](#)

“Instruments for
surgical procedures”
Since 1970

PROBES APPLICATORS SPATULAS



Probes Applicators Spatulas
probe, button end, Ø 2.0 mm

Material: steel 18/8 martinit,
antimagnetic, stainless, acid-resistant

Other Sizes:

007-0100-11	11.5 cm
007-0100-13	13.5 cm
007-0100-14	14.5 cm
007-0100-16	16 cm
007-0100-18	18 cm
007-0100-20	20 cm
007-0100-25	25 cm
007-0100-30	30 cm



Probes Applicators Spatulas
probe, button end, Ø 1.0 mm

Material: steel 18/8 martinit,
antimagnetic, stainless, acid-resistant

Other Sizes:

007-0102-11	11.5 cm
007-0102-13	13 cm
007-0102-14	14.5 cm
007-0102-16	16 cm
007-0102-18	18 cm
007-0102-30	20 cm



Probes Applicators Spatulas
probe, button end, Ø 1.5 mm

Material: steel 18/8 martinit,
antimagnetic, stainless, acid-resistant

Other Sizes:

007-0103-13	13 cm
007-0103-14	14.5 cm
007-0103-16	16 cm
007-0103-18	18 cm
007-0103-20	20 cm
007-0103-25	25 cm



Probes Applicators Spatulas
probe with eye, Ø 2.0 mm

Material: steel 18/8 martinit,
antimagnetic, stainless, acid-resistant

Other Sizes:

007-0108-13	13 cm
007-0108-14	14.5 cm
007-0108-16	16 cm



Probes Applicators Spatulas
Ear probe, acc. to Stacke, silver, Ø 1.0 mm

Material: Silver

Other Sizes:

007-0130-10	10 cm
-------------	-------



Probes Applicators Spatulas
Myrtle leaf probe, Ø 2.0 mm

Material: Stainless steel

Other Sizes:

007-0150-13	13 cm
007-0150-14	14.5 cm
007-0150-18	18 cm
007-0150-20	20 cm

PROBES APPLICATORS SPATULAS



Probes Applicators Spatulas

Grooved director, straight

Material: steel 18/8 martinit,
antimagnetic, stainless, acid-resistant

Other Sizes:

007-0160-13	13 cm
007-0160-14	14 cm
007-0160-16	16 cm



Probes Applicators Spatulas

Grooved director, button ended

Material: steel 18/8 martinit,
antimagnetic, stainless, acid-resistant

Other Sizes:

007-0170-13	13 cm
007-0170-14	14.5 cm
007-0170-16	16 cm



Probes Applicators Spatulas

Grooved director, acc. to acc.
to Doyen, curved

Material: steel 18/8 martinit,
antimagnetic, stainless, acid-resistant

Other Sizes:

007-0175-14	14.5 cm
-------------	---------



Probes Applicators Spatulas

Grooved director, acc. to Nelaton, curved

Material: steel 18/8 martinit,
antimagnetic, stainless, acid-resistant

Other Sizes:

007-0185-16	16 cm
-------------	-------



Probes Applicators Spatulas

Fistula probe, straight

Material: Stainless steel

Other Sizes:

007-0186-16	16.5 cm
-------------	---------



Probes Applicators Spatulas

Fistula probe, slight curved

Material: Stainless steel

Other Sizes:

007-0187-16	16.5 cm
-------------	---------

PROBES APPLICATORS SPATULAS

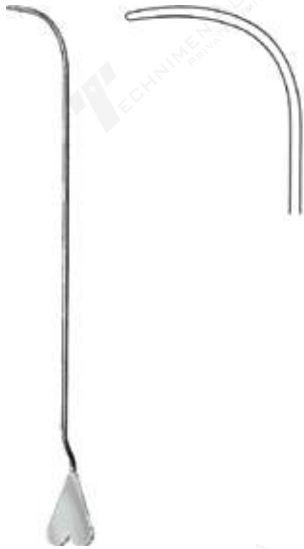

Probes Applicators Spatulas

Fistula probe, 90° curved

Material: Stainless steel

Other Sizes:

007-0189-16 | 16.5 cm



Probes Applicators Spatulas

Fistula probe, strong curved

Material: Stainless steel

Other Sizes:

007-0191-16 | 16.5 cm



Probes Applicators Spatulas

Varicose vein set, acc. to Varady, complete

Material: steel 18/8 martinit, antimagnetic, stainless, acid-resistant

Other Sizes:

007-0248-00 | N/A

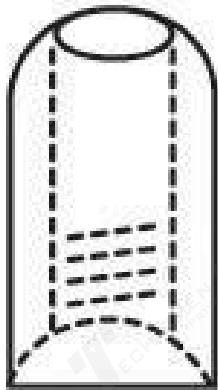

Probes Applicators Spatulas

Tip, only, for 007-0248-00

Material: Stainless steel

Other Sizes:

007-0248-01 | Ø 3 mm
007-0248-02 | Ø 4 mm
007-0248-03 | Ø 5 mm
007-0248-04 | Ø 6 mm



Probes Applicators Spatulas

Phlebotomizer, acc. to Varady

Material: Stainless steel

Other Sizes:

007-0249-01 | 18 cm



Probes Applicators Spatulas

Phlebotomizer, acc. to Varady

Material: Stainless steel

Other Sizes:

007-0249-02 | 18 cm

PROBES APPLICATORS SPATULAS

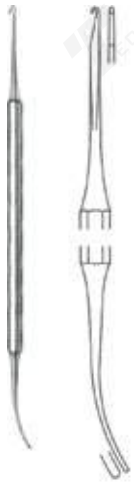

Probes Applicators Spatulas
Phlebextractor, acc. to Varady

Material: Stainless steel

Other Sizes:
007-0249-03 18 cm

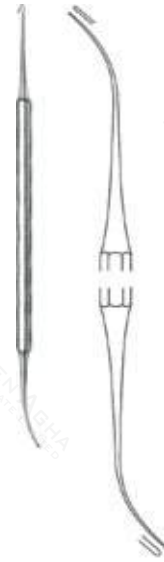

Probes Applicators Spatulas
Microdissektor, acc. to Varady

Material: Stainless steel

Other Sizes:
007-0249-04 17.5 cm



Probes Applicators Spatulas
Micro-Phlebextractor, acc. to Varady

Material: Stainless steel

Other Sizes:
007-0249-05 17.5 cm

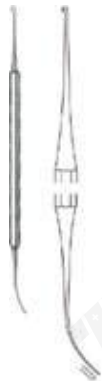

Probes Applicators Spatulas
Mini-Phlebextractor, acc. to Varady

Material: Stainless steel

Other Sizes:
007-0249-06 17.5 cm



Probes Applicators Spatulas
Varicose vein set, acc. to Nabatoff, complete

Material: steel 18/8 martinit,
antimagnetic, stainless, acid-resistant

Other Sizes:
007-0250-00 N/A

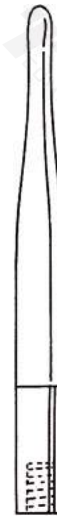

Probes Applicators Spatulas
Plastic tip, only, for 007-0250-00

Material: steel 18/8 martinit,
antimagnetic, stainless, acid-resistant

Other Sizes:
007-0250-02 N/A

PROBES APPLICATORS SPATULAS

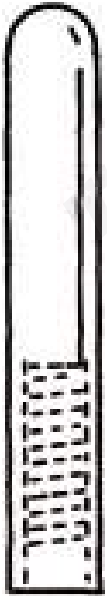

Probes Applicators Spatulas
Tip, for 007-0250-00

Material: Stainless steel

Other Sizes:
007-0250-03 : Ø 3 mm

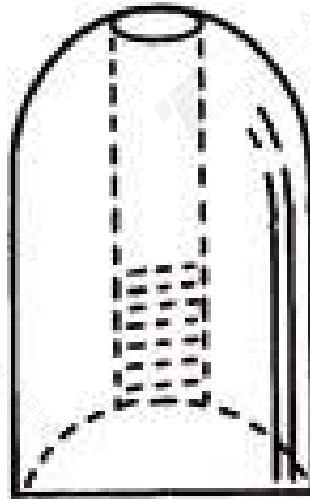

Probes Applicators Spatulas
Tip, for 007-0250-00

Material: Stainless steel

Other Sizes:
007-0250-06 : Ø 6 mm
007-0250-09 : Ø 9 mm
007-0250-12 : Ø 12 mm

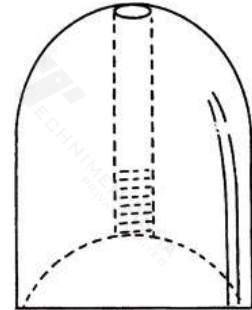

Probes Applicators Spatulas
Tip, for 007-0250-00

Material: Stainless steel

Other Sizes:
007-0250-15 : Ø 15 mm

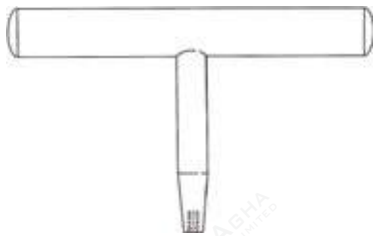

Probes Applicators Spatulas
T-Handle, for 007-0250-00

Material: Stainless steel

Other Sizes:
007-0250-80 : N/A



Probes Applicators Spatulas
Traction cable, flexible, for 007-0250-00

Material: Stainless steel

Other Sizes:
007-0250-90 : 90 cm



Probes Applicators Spatulas
Ring stripper, round

Material: steel 18/8 martinit,
antimagnetic, stainless, acid-resistant

Other Sizes:
007-0251-02 : Ø 2.0 mm, 50 cm
007-0251-03 : Ø 3.0 mm, 50 cm
007-0251-04 : Ø 4.0 mm, 50 cm
007-0251-06 : Ø 6.0 mm, 50 cm
007-0251-07 : Ø 7.0 mm, 50 cm
007-0251-08 : Ø 8.0 mm, 50 cm
007-0251-10 : Ø 10.0 mm, 50 cm
007-0251-12 : Ø 12.0 mm, 50 cm
007-0251-14 : Ø 14.0 mm, 50 cm

PROBES APPLICATORS SPATULAS



Probes Applicators Spatulas

Handle for strippers, round

Material: steel 18/8 martinit,
antimagnetic, stainless, acid-resistant

Other Sizes:

007-0251-30 : 11.5 cm



Probes Applicators Spatulas

N/A

Material: Stainless steel

Other Sizes:

007-0410-12 : 12 cm
007-0410-14 : 14 cm
007-0410-16 : 16 cm



Probes Applicators Spatulas

Cotton application, acc. to Farell,
Ø 0.9 mm

Material: steel 18/8 martinit,
antimagnetic, stainless, acid-resistant

Other Sizes:

007-0420-12 : 12 cm
007-0420-14 : 14 cm
007-0420-16 : 16 cm



Probes Applicators Spatulas

Cotton application, acc. to Farell

Material: Stainless steel

Other Sizes:

007-0425-12 : Ø 1.2 mm, 14 cm

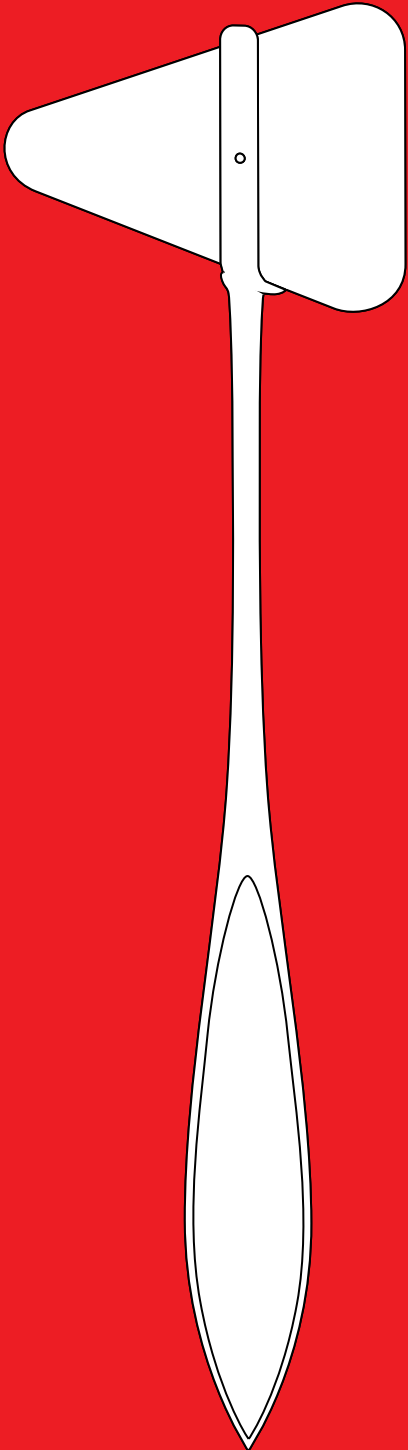

DIAGNOSTICS

— RANGE

[DISCOVER NOW](#)

“Instruments for
surgical procedures”
Since 1970

DIAGNOSTICS



Diagnostics
N/A

Material: Stainless steel

Other Sizes:
008-0155-18 : 18.5 cm



Diagnostics
N/A

Material: Stainless steel

Other Sizes:
008-0156-18 : 20 cm



Diagnostics
N/A

Material: Stainless steel

Other Sizes:
008-0184-20 : 20 cm



Diagnostics
N/A

Material: Stainless steel

Other Sizes:
008-0185-21 : 21 cm



Diagnostics
N/A

Material: Stainless steel

Other Sizes:
008-0190-20 : 20 cm



Diagnostics
N/A

Material: Stainless steel

Other Sizes:
008-0210-19 : 18 cm

TROGCARS & SUCTION TUBES

— RANGE

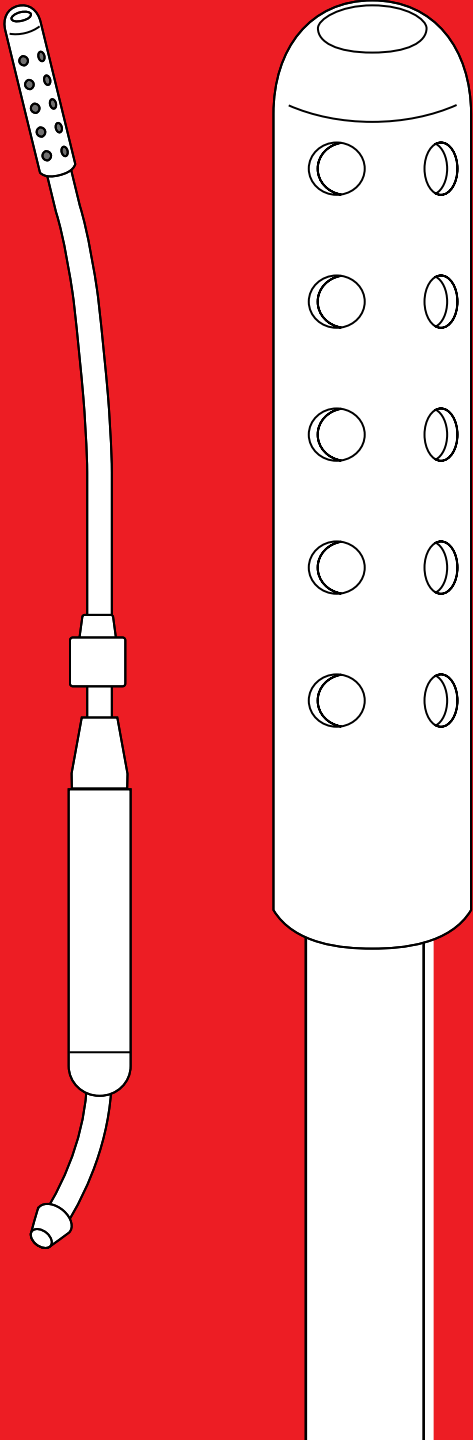

[DISCOVER NOW](#)

“Instruments for
surgical procedures”
Since 1970

TROCARS & SUCTION TUBES



Trocars & Suction Tubes
Trocar, universal, set with 4 pieces

Material: Stainless steel

Other Sizes:
009-0306-04 14 cm



Trocars & Suction Tubes
Trocar, acc. to Nelson, no. 1

Material: steel 18/8 martinit, antimagnetic, stainless, acid-resistant

Other Sizes:
009-0348-07 Ø 7.5 mm, 21 cm
009-0350-09 Ø 9.5 mm, 21 cm
009-0352-11 Ø 11 mm, 21 cm



Trocars & Suction Tubes
Suction tube, pediatric, 45°

Material: Stainless steel

Other Sizes:
009-0510-33 Ø 3,3 mm, 18 cm
009-0510-50 Ø 5,0 mm, 18 cm



Trocars & Suction Tubes
Suction tube, pediatric, 90°

Material: Stainless steel

Other Sizes:
009-0511-33 Ø 3,3 mm, 16 cm
009-0511-50 Ø 5,0 mm, 16 cm



Trocars & Suction Tubes
Suction tube, pediatric, 45°

Material: Stainless steel

Other Sizes:
009-0512-33 Ø 3,3 mm, 21 cm
009-0512-50 Ø 5,0 mm, 21 cm



Trocars & Suction Tubes
Suction tube, pediatric, 60°

Material: Stainless steel

Other Sizes:
009-0513-33 Ø 3,3 mm, 18 cm
009-0513-50 Ø 5,0 mm, 18 cm

TROCARS & SUCTION TUBES



Trocars & Suction Tubes

Suction tube, pediatric, 90°

Material: Stainless steel

Other Sizes:

009-0514-33 Ø 3,3 mm, 15 cm
009-0514-50 Ø 5,0 mm, 15 cm



Trocars & Suction Tubes

Suction tube, acc. to Marcore,
Ø 6 mm, with cutoff

Material: Stainless steel

Other Sizes:

009-0516-60 39 cm



Trocars & Suction Tubes

Suction tube, acc. to Adson, curved

Material: steel 18/8 martinit,
antimagnetic, stainless, acid-resistant

Other Sizes:

009-0521-21 Ø 4 mm, 20 cm



Trocars & Suction Tubes

Suction tube, acc. to Frazier, straight

Material: steel 18/8 martinit,
antimagnetic, stainless, acid-resistant

Other Sizes:

009-0522-10 Ø 3.3 mm, 24 cm



Trocars & Suction Tubes

Suction tube, acc. to Frazier

Material: steel 18/8 martinit,
antimagnetic, stainless, acid-resistant

Other Sizes:

009-0523-06 2.0 mm, 19.5 cm
009-0523-07 2.3 mm, 19.5 cm
009-0523-08 2.7 mm, 19.5 cm
009-0523-09 3.0 mm, 19.5 cm
009-0523-10 3.3 mm, 19.5 cm
009-0523-11 3.6 mm, 19.5 cm
009-0523-12 4.0 mm, 19.5 cm
009-0523-13 5.0 mm, 19.5 cm



Trocars & Suction Tubes

Suction tube, acc. to Fergusson,
working length 110 mm

Material: steel 18/8 martinit,
antimagnetic, stainless, acid-resistant

Other Sizes:

009-0524-15 1.5 mm
009-0524-20 2.0 mm
009-0524-25 2.5 mm
009-0524-30 3.0 mm
009-0524-40 3.5 mm
009-0524-50 4.0 mm

TROCARS & SUCTION TUBES



Trocars & Suction Tubes

Suction tube, acc. to Poppen, angled

Material: steel 18/8 martinit, antimagnetic, stainless, acid-resistant

Other Sizes:

009-0525-06	2.0 mm, 18 cm
009-0525-08	2.6 mm, 18 cm
009-0525-10	3.3 mm, 18 cm
009-0525-12	4.0 mm, 18 cm



Trocars & Suction Tubes

Suction tube, acc. to Zoellner

Material: steel 18/8 martinit, antimagnetic, stainless, acid-resistant

Other Sizes:

009-0526-00	N/A
-------------	-----



Trocars & Suction Tubes

Suction tube, acc. to Wullstein, with 3 cannulas

Material: steel 18/8 martinit, antimagnetic, stainless, acid-resistant

Other Sizes:

009-0527-00	N/A
-------------	-----



Trocars & Suction Tubes

Suction Handle, acc. to Wullstein

Material: steel 18/8 martinit, antimagnetic, stainless, acid-resistant

Other Sizes:

009-0527-01	14 cm
-------------	-------



Trocars & Suction Tubes

Micro suction tube, acc. to Wullstein

Material: steel 18/8 martinit, antimagnetic, stainless, acid-resistant

Other Sizes:

009-0527-04	Ø 0.4 mm
009-0527-06	Ø 0.6 mm
009-0527-08	Ø 0.8 mm



Trocars & Suction Tubes

Suction tube, acc. to Baron-Schuknecht

Material: steel 18/8 martinit, antimagnetic, stainless, acid-resistant

Other Sizes:

009-0528-10	1.0 x 75 mm
009-0528-15	1.5 x 75 mm
009-0528-20	2.0 x 75 mm

TROCARS & SUCTION TUBES



Trocars & Suction Tubes

Suction tube, acc. to Luer,
working length 110 mm

Material: Stainless steel

Other Sizes:

009-0529-30	∅ 3.0 mm, 16.5 cm
009-0529-35	∅ 3.5 mm, 16.5 cm
009-0529-45	∅ 4.5 mm, 18 cm



Trocars & Suction Tubes

Suction Handle with cut-off

Material: Stainless steel

Other Sizes:

009-0531-01	N/A
-------------	-----



Trocars & Suction Tubes

Suction tube forpituatory, acc. to Landolt

Material: Stainless steel

Other Sizes:

009-0533-01	3.2 mm
-------------	--------



Trocars & Suction Tubes

Suction valve, acc. to Cerullo

Material: Stainless steel

Other Sizes:

009-0535-00	N/A
-------------	-----



Trocars & Suction Tubes

Suction tube, acc. to acc. to Yasargil,
working length 150 mm

Material: steel 18/8 martinit,
antimagnetic, stainless, acid-resistant

Other Sizes:

009-0540-15	∅ 1.5 mm
009-0540-20	∅ 2.0 mm
009-0540-25	∅ 2.5 mm
009-0540-35	∅ 3.5 mm



Trocars & Suction Tubes

Suction tube, acc. to Baby-Yankauer

Material: steel 18/8 martinit,
antimagnetic, stainless, acid-resistant

Other Sizes:

009-0542-21	210 mm
-------------	--------

TROCARS & SUCTION TUBES



Trocars & Suction Tubes

Suction tube, acc. to Yankauer, complete

Material: steel 18/8 martinit, antimagnetic, stainless, acid-resistant

Other Sizes:
009-0543-10 : 31 cm



Trocars & Suction Tubes

Suction tube, acc. to De Bakey-Adson

Material: Stainless steel

Other Sizes:
009-0544-16 : Ø 4 mm, 16 cm
009-0544-20 : Ø 4 mm, 20 cm



Trocars & Suction Tubes

Suction tube, acc. to De Bakey

Material: Stainless steel

Other Sizes:
009-0544-28 : Ø 9 mm, 28 cm



Trocars & Suction Tubes

Suction tube, acc. to Yankauer, set with 4 tubes

Material: steel 18/8 martinit, antimagnetic, stainless, acid-resistant

Other Sizes:
009-0545-00 : 31 cm



Trocars & Suction Tubes

Handle, only, for 009-0545-00

Material: steel 18/8 martinit, antimagnetic, stainless, acid-resistant

Other Sizes:
009-0545-01 : 15 cm



Trocars & Suction Tubes

Tube connector, only for 009-0545-00

Material: steel 18/8 martinit, antimagnetic, stainless, acid-resistant

Other Sizes:
009-0545-02 : 2.5 cm

TROCARS & SUCTION TUBES



Trocars & Suction Tubes
Suction tube, no. 0, for 18-545-00-01

Material: steel 18/8 martinit, antimagnetic, stainless, acid-resistant

Other Sizes:
009-0545-10 : 10 cm



Trocars & Suction Tubes
Suction tube, no. 1, for 009-0545-00

Material: steel 18/8 martinit, antimagnetic, stainless, acid-resistant

Other Sizes:
009-0545-11 : 10 cm



Trocars & Suction Tubes
Suction tube, no. 2, for 009-0545-00

Material: steel 18/8 martinit, antimagnetic, stainless, acid-resistant

Other Sizes:
009-0545-12 : 10 cm



Trocars & Suction Tubes
Suction tube, no. 3, for 009-0545-00

Material: steel 18/8 martinit, antimagnetic, stainless, acid-resistant

Other Sizes:
009-0545-13 : 13.5 cm



Trocars & Suction Tubes
Suction tip, only, for 009-0545-00

Material: steel 18/8 martinit, antimagnetic, stainless, acid-resistant

Other Sizes:
009-0545-15 : 9,9 mm



Trocars & Suction Tubes
Suction tube, acc. to Baby-Poole, straight

Material: steel 18/8 martinit, antimagnetic, stainless, acid-resistant

Other Sizes:
009-0548-19 : 190 mm

TROCARS & SUCTION TUBES



Trocars & Suction Tubes

Suction tube, acc. to Baby-Poole, curved, 190 mm

Material: steel 18/8 martinit, antimagnetic, stainless, acid-resistant

Other Sizes:
009-0549-19 : 6 mm, 19 cm



Trocars & Suction Tubes

Suction tube, acc. to Poole, straight, Ø 10 mm

Material: steel 18/8 martinit, antimagnetic, stainless, acid-resistant

Other Sizes:
009-0550-22 : 22 cm



Trocars & Suction Tubes

Suction tube, acc. to Poole, angled, Ø 8 mm

Material: steel 18/8 martinit, antimagnetic, stainless, acid-resistant

Other Sizes:
009-0551-22 : 22.5 cm



Trocars & Suction Tubes

Suction tube, acc. to House

Material: steel 18/8 martinit, antimagnetic, stainless, acid-resistant

Other Sizes:
009-0553-09 : 0.9 x 0.7 mm, 9 cm
009-0554-09 : 1.2 x 0.9 mm, 9 cm
009-0555-09 : 1.5 x 1.2 mm, 9 cm

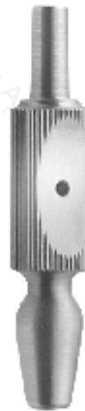

Trocars & Suction Tubes

Suction adapter, acc. to House

Material: Stainless steel

Other Sizes:
009-0556-06 : 4.5 cm



Trocars & Suction Tubes

Suction tube, acc. to Cooley, curved, Ø 8 mm

Material: steel 18/8 martinit, antimagnetic, stainless, acid-resistant

Other Sizes:
009-0561-35 : 36 cm

TROCARS & SUCTION TUBES



Trocars & Suction Tubes

Suction tube, acc. to Cooley, curved,
Ø 10 mm

Material: steel 18/8 martinit,
antimagnetic, stainless, acid-resistant

Other Sizes:
009-0563-31 : 31 cm



Trocars & Suction Tubes

Suction tube, acc. to Cooley, curved,
Ø 7 mm

Material: steel 18/8 martinit,
antimagnetic, stainless, acid-resistant

Other Sizes:
009-0565-30 : 31 cm



Trocars & Suction Tubes

Suction tube, acc. to Cooley, curved,
Ø 8 mm

Material: steel 18/8 martinit,
antimagnetic, stainless, acid-resistant

Other Sizes:
009-0567-33 : 36 cm



Trocars & Suction Tubes

Suction tube, with perforated screw tip

Material: Stainless steel

Other Sizes:
009-0568-28 : Ø 6 mm, 28 cm



Trocars & Suction Tubes

Valvular suction tube

Material: Stainless steel

Other Sizes:
009-0568-30 : Ø 6 mm, 30 cm



Trocars & Suction Tubes

Suction tube, acc. to Nuboer, round

Material: steel 18/8 martinit,
antimagnetic, stainless, acid-resistant

Other Sizes:
009-0569-21 : Ø 6 mm, 21 cm

TROCARS & SUCTION TUBES



Trocars & Suction Tubes

Suction tube, acc. to Nuboer, oval

Material: steel 18/8 martinit, antimagnetic, stainless, acid-resistant

Other Sizes:

009-0571-21 Ø 6 mm, 21 cm



Trocars & Suction Tubes

Suction tube, acc. to Jamieson

Material: Stainless steel

Other Sizes:

009-0572-05 Ø 0,5 mm, 27 cm
009-0572-10 Ø 1,0 mm, 27 cm
009-0572-15 Ø 1,5 mm, 27 cm



Trocars & Suction Tubes

Suction tube, acc. to Jamieson, 30°

Material: Stainless steel

Other Sizes:

009-0573-05 Ø 0,5 mm, 27 cm
009-0573-10 Ø 1,0 mm, 27 cm



Trocars & Suction Tubes

Suction tip, acc. to Coupland

Material: steel 18/8 martinit, antimagnetic, stainless, acid-resistant

Other Sizes:

009-0575-05 Ø 1.5 mm, 9 cm
009-0575-06 Ø 2.0 mm, 9 cm
009-0575-07 Ø 2.5 mm, 9 cm
009-0575-08 Ø 3.5 mm, 9 cm



Trocars & Suction Tubes

Suction Handle, acc. to Coupland

Material: steel 18/8 martinit, antimagnetic, stainless, acid-resistant

Other Sizes:

009-0575-24 17 cm



Trocars & Suction Tubes

Suction tube, acc. to Byrd

Material: steel 18/8 martinit, antimagnetic, stainless, acid-resistant

Other Sizes:

009-0577-01 Ø 3.0 mm, 21.5 cm
009-0577-02 Ø 3.5 mm, 21.5 cm
009-0577-03 Ø 4.3 mm, 21.5 cm

TROCARS & SUCTION TUBES



Trocars & Suction Tubes

Suction tube, acc. to Cogswell

Material: steel 18/8 martinit, antimagnetic, stainless, acid-resistant

Other Sizes:

009-0579-23 Ø 3.8 mm, 24.5 cm



Trocars & Suction Tubes

Guide needle, angled, knife shape

Material: Stainless steel

Other Sizes:

009-0580-08	8 Ch
009-0580-10	10 Ch
009-0580-12	12 Ch
009-0580-14	14 Ch
009-0580-16	16 Ch
009-0580-18	18 Ch



Trocars & Suction Tubes

Guide needle, curved, knife shape

Material: steel 18/8 martinit, antimagnetic, stainless, acid-resistant

Other Sizes:

009-0581-08	8 Ch
009-0581-10	10 Ch
009-0581-12	12 Ch
009-0581-14	14 Ch
009-0581-16	16 Ch
009-0581-18	18 Ch



Trocars & Suction Tubes

Guide needle, angled, lancet shape

Material: Stainless steel

Other Sizes:

009-0583-08	8 Ch
009-0583-10	10 Ch
009-0583-12	12 Ch
009-0583-14	14 Ch
009-0583-16	16 Ch
009-0583-18	18 Ch



Trocars & Suction Tubes

Guide needle, angled, triangular

Material: Stainless steel

Other Sizes:

009-0584-08	8 Ch
009-0584-10	10 Ch
009-0584-12	12 Ch
009-0584-14	14 Ch
009-0584-16	16 Ch
009-0584-18	18 Ch



Trocars & Suction Tubes

Pudendus anaesthesia cannula

Material: steel 18/8 martinit, antimagnetic, stainless, acid-resistant

Other Sizes:

009-0606-00 18 cm

TROCARS & SUCTION TUBES



Trocars & Suction Tubes

Cannula for 009-0606-00

Material: steel 18/8 martinit,
antimagnetic, stainless, acid-resistant

Other Sizes:
009-0606-01 : 1.0 x 185 mm



Trocars & Suction Tubes

Vein cannula, button-ended

Material: Stainless steel

Other Sizes:
009-0610-12 : 1.2 x 80 mm
009-0610-15 : 1.5 x 80 mm



Trocars & Suction Tubes

cannula, Heparin

Material: Stainless steel

Other Sizes:
009-0611-20 : Ø 2 mm, 45 mm
009-0611-30 : Ø 3 mm, 45 mm
009-0611-37 : Ø 3,7 mm, 55 mm
009-0611-50 : Ø 5,0 mm, 60 mm
009-0696-06 : Ø 2,9 mm, 65 mm



Trocars & Suction Tubes

Puncture needle, acc. to Tuohy,
acc. to Luer / Lock

Material: Stainless steel

Other Sizes:
009-0632-12 : 1.2 x 76 mm
009-0632-14 : 1.4 x 76 mm
009-0632-16 : 1.6 x 76 mm



Trocars & Suction Tubes

Suction tube, acc. to acc. to Verhoeven

Material: Stainless steel

Other Sizes:
009-0635-10 : 1.5 mm, 10 cm



Trocars & Suction Tubes

Tonsil cannula, straight

Material: Stainless steel

Other Sizes:
009-0640-10 : 0.65 x 19 mm

TROCARS & SUCTION TUBES



Trocars & Suction Tubes
Tonsil cannula, curved

Material: Stainless steel

Other Sizes:
009-0640-15 : 0.80 x 13 mm



Trocars & Suction Tubes
Tonsil cannula, angled

Material: Stainless steel

Other Sizes:
009-0640-20 : 0.65 x 13 mm



Trocars & Suction Tubes
Tonsil cannula, angled

Material: Stainless steel

Other Sizes:
009-0641-20 : 1.0 x 13 mm
009-0642-20 : 1.3 x 13 mm



Trocars & Suction Tubes
Suction cannula, malleable

Material: Stainless steel

Other Sizes:
009-0647-15 : 1.5 mm, 16 cm
009-0647-20 : 2.0 mm, 16 cm



Trocars & Suction Tubes
Insufflation-cannula, acc. to Verres

Material: Stainless steel

Other Sizes:
009-0665-20 : 2.0 x 100 mm



Trocars & Suction Tubes
Insufflation-cannula, acc. to Verres

Material: Stainless steel

Other Sizes:
009-0666-20 : 2.0 x 120 mm

TROCARS & SUCTION TUBES



Trocars & Suction Tubes
Vessel irrigation cannula

Material: Stainless steel

Other Sizes:

009-0691-15	1.5 mm, 6 cm
009-0691-20	2.0 mm, 6 cm
009-0691-25	2.5 mm, 6 cm
009-0691-30	3.0 mm, 6 cm
009-0691-40	4.0 mm, 6 cm



Trocars & Suction Tubes
Heparin needle, acc. to Mock, button-end

Material: steel 18/8 martinit, antimagnetic, stainless, acid-resistant

Other Sizes:

009-0696-06	6.5 cm
-------------	--------



Trocars & Suction Tubes
Puncture needle, acc. to Menghini

Material: Stainless steel

Other Sizes:

009-0700-10	1.0 x 35 mm
009-0700-15	1.0 x 70 mm
009-0700-20	1.2 x 70 mm
009-0700-25	1.2 x 100 mm
009-0700-30	1.4 x 70 mm
009-0700-35	1.4 x 100 mm
009-0700-40	1.6 x 70 mm
009-0700-50	1.8 x 100 mm



Trocars & Suction Tubes
Puncture needle, acc. to Menghini

Material: chrome-plated

Other Sizes:

009-0710-18	1.8 x 168 mm
-------------	--------------



Trocars & Suction Tubes
Connector, Luer-Lock female, Record male

Material: chrome-plated

Other Sizes:

009-0800-00	N/A
-------------	-----



Trocars & Suction Tubes
Connector, for catheter tube

Material: chrome-plated

Other Sizes:

009-0850-03	Ø 3 mm
009-0850-04	Ø 4 mm
009-0850-05	Ø 5 mm
009-0850-06	Ø 6 mm
009-0850-07	Ø 7 mm
009-0850-08	Ø 8 mm
009-0850-09	Ø 9 mm
009-0850-10	Ø 10 mm
009-0850-11	Ø 11 mm
009-0850-12	Ø 12 mm
009-0850-13	Ø 13 mm

TROCARS & SUCTION TUBES



Trocars & Suction Tubes
Connector, Luer-Lock female, Record male

Material: chrome-plated

Other Sizes:
009-0802-00 N/A



Trocars & Suction Tubes
Tube connector, Luer-Lock, male

Material: chrome-plated

Other Sizes:
009-0804-00 N/A



Trocars & Suction Tubes
Tube connector, Luer-Lock, female

Material: chrome-plated

Other Sizes:
009-0806-00 N/A



Trocars & Suction Tubes
Catheter fitting, conic

Material: chrome-plated

Other Sizes:
009-0825-01 2.5 x 4.0 mm
009-0825-02 2.5 x 6.5 mm
009-0825-03 3.0 x 9.0 mm



Trocars & Suction Tubes
Urethral olive, Luer-Lock, female

Material: chrome-plated

Other Sizes:
009-0830-00 N/A



Trocars & Suction Tubes
Stopcock, Luer-Lock, female/male

Material: chrome-plated

Other Sizes:
009-0840-00 N/A

TROCARS & SUCTION TUBES



Trocars & Suction Tubes

Stopcock, Luer-Lock, 1 x male/2 x female

Material: chrome-plated

Other Sizes:

009-0845-00 : N/A



Trocars & Suction Tubes

Syringe "Record", glas barrel, Luer-cone

Material: all other, not specially marked material types

Other Sizes:

009-0900-01 : 1 ml
009-0900-02 : 2 ml
009-0900-05 : 5 ml
009-0900-10 : 10 ml
009-0900-20 : 20 ml
009-0900-50 : 50 ml



Trocars & Suction Tubes

Spare barrel, glas, Luer-cone, for 009-0900-01

Material: all other, not specially marked material types

Other Sizes:

009-0902-01 : 1 ml
009-0902-02 : 2 ml
009-0902-05 : 5 ml
009-0902-10 : 10 ml
009-0902-20 : 20 ml
009-0902-50 : 50 ml



Trocars & Suction Tubes

Syringe "Record", glas barrel, Luer-Lock connection

Material: all other, not specially marked material types

Other Sizes:

009-0910-01 : 1 ml
009-0910-02 : 2 ml
009-0910-05 : 5 ml
009-0910-10 : 10 ml
009-0910-20 : 20 ml
009-0910-50 : 50 ml



Trocars & Suction Tubes

Spare barrel, glas, Luer-Lock connection, for 009-0910-01

Material: all other, not specially marked material types

Other Sizes:

009-0912-01 : 1 ml
009-0912-02 : 2 ml
009-0912-05 : 5 ml
009-0912-10 : 10 ml
009-0912-20 : 20 ml
009-0912-50 : 50 ml



Trocars & Suction Tubes

Syringe, glas barrel, three rings, Luer-Lock connection

Material: all other, not specially marked material types

Other Sizes:

009-0915-02 : 2 ml
009-0915-05 : 5 ml
009-0915-10 : 10 ml

TROCARS & SUCTION TUBES



Trocars & Suction Tubes

Spare barrel, glas, Luer-Lock connection, for 009-0915-02

Material: all other, not specially marked material types

Other Sizes:

009-0917-02	2 ml
009-0917-05	5 ml
009-0917-10	10 ml



Trocars & Suction Tubes

Insulin syringe, glas barrel, Luer-cone, 40 E

Material: all other, not specially marked material types

Other Sizes:

009-0920-01	1 ml
18-920-02-04	2 ml



Trocars & Suction Tubes

Spare barrel, glas, Luer-cone, 40 E, for 009-0920-01

Material: all other, not specially marked material types

Other Sizes:

009-0922-01	1 ml
009-0922-02	2 ml



Trocars & Suction Tubes

Tuberculin syringe, glas barrel, Luer-Lock connection

Material: all other, not specially marked material types

Other Sizes:

009-0925-01	1 ml
-------------	------



Trocars & Suction Tubes

Spare barrel, glas, Luer-Lock connection, for 009-0925-01

Material: all other, not specially marked material types

Other Sizes:

009-0926-01	1 ml
-------------	------



Trocars & Suction Tubes

Wound and Bladdersyringe, glas barrel, acc. to Janet

Material: all other, not specially marked material types

Other Sizes:

009-0930-05	50 ml
009-0930-10	100 ml
009-0930-15	150 ml
009-0930-20	200 ml

TROCARS & SUCTION TUBES



Trocars & Suction Tubes

Spare barrel for Janet syringe, glas, for 009-0930-05

Material: all other, not specially marked material types

Other Sizes:

009-0932-05	50 ml
009-0932-10	100 ml
009-0932-15	150 ml
009-0932-20	200 ml



Trocars & Suction Tubes

Suction tube, acc. to Frazier

Material: steel 18/8 martinit, antimagnetic, stainless, acid-resistant

Other Sizes:

18-523-06-06	2.0mm 19.5 cm
18-523-06-07	2.3 mm 19.5 cm
18-523-06-08	2.7 mm 19.5 cm
18-523-06-09	3.0 mm 19.5 cm
18-523-06-10	3.3 mm 19.5 cm
18-523-06-11	3.6 mm 19.5 cm
18-523-06-12	4.0 mm 19.5 cm
18-523-06-13	5.0 mm 19.5 cm



Trocars & Suction Tubes

Tonsil cannula, angled,

Material: stainless steel

Other Sizes:

009-0641-20	1.0 x 13 mm
009-0642-20	1.3 x 13 mm

ANAESTHESIA & DIAGNOSTICS — RANGE

DISCOVER NOW

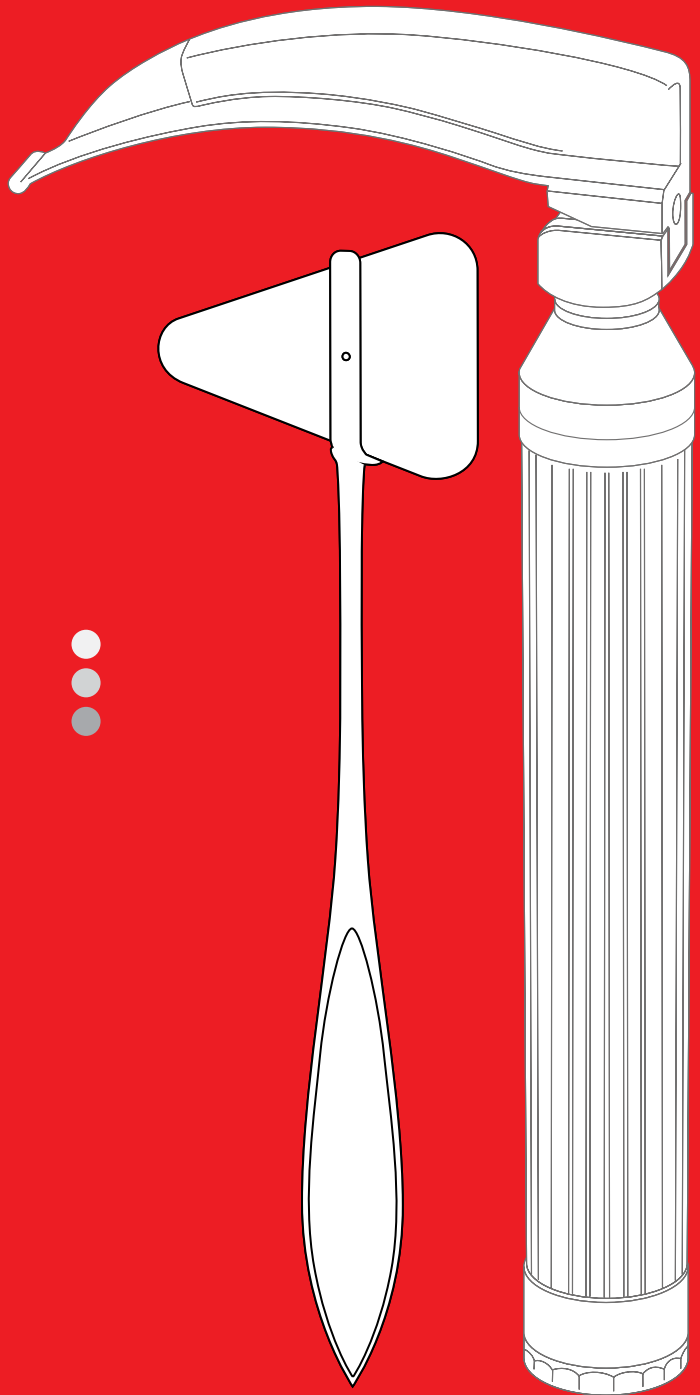

“Instruments for
surgical procedures”
Since 1970



Anaesthesia

Catheter introducing forceps, acc. to Magill

Material: Stainless steel

Other Sizes:

010-0301-15 | 14.5 cm



Anaesthesia

Catheter introducing forceps, acc. to Magill

Material: Stainless steel

Other Sizes:

010-0301-20 | 20 cm



Anaesthesia

Catheter introducing forceps, acc. to Magill

Material: Stainless steel

Other Sizes:

010-0303-25 | 25 cm



Anaesthesia

Laryngoscope set, acc. to Miller-Baby

Material: Stainless steel

Other Sizes:

010-0350-00 | ...
010-0351-00 | ...
010-0352-00 | ...



Anaesthesia

Laryngoscope blade, acc. to Miller-Baby, no. 0

Material: Stainless steel

Other Sizes:

010-0353-00 | 55 mm



Anaesthesia

Laryngoscope blade, acc. to Miller-Baby, no. 1

Material: Stainless steel

Other Sizes:

010-0353-01 | 80 mm



Anaesthesia

Laryngoscope blade, acc. to Miller-Baby, no. 2

Material: Stainless steel

Other Sizes:

010-0353-02 130 mm



Anaesthesia

Laryngoscope blade, acc. to Miller-Baby

Material: Stainless steel

Other Sizes:

010-0353-03 170 mm



Anaesthesia

Laryngoscope blade, acc. to Miller-Baby

Material: Stainless steel

Other Sizes:

010-0353-04 180 mm



Anaesthesia

Laryngoscope set, acc. to Guedel-Negus

Material: Stainless steel

Other Sizes:

010-0360-00 ...

010-0361-00 ...



Anaesthesia

Laryngoscope blade, acc. to Guedel-Negus

Material: Stainless steel

Other Sizes:

010-0363-01 70 mm

010-0363-02 90 mm

010-0363-03 110 mm

010-0363-04 135 mm



Anaesthesia

Laryngoscope set, acc. to McIntosh

Material: Stainless steel

Other Sizes:

010-0380-00 ...

010-0384-00 ...



Anaesthesia
Laryngoscope blade, acc. to McIntosh, no. 0

Material: Stainless steel

Other Sizes:
010-0383-00 55 mm



Anaesthesia
Laryngoscope blade, acc. to McIntosh, no. 1

Material: Stainless steel

Other Sizes:
010-0383-01 75 mm



Anaesthesia
Laryngoscope blade, acc. to McIntosh, no. 2

Material: Stainless steel

Other Sizes:
010-0383-02 90 mm



Anaesthesia
Laryngoscope blade, acc. to McIntosh, no. 3

Material: Stainless steel

Other Sizes:
010-0383-03 110 mm



Anaesthesia
Laryngoscope blade, acc. to McIntosh, no. 4

Material: Stainless steel

Other Sizes:
010-0383-04 135 mm



Anaesthesia
Laryngoscope blade acc. to Foregger, no. 1

Material: Stainless steel

Other Sizes:
010-0387-01 70 mm



Anaesthesia
Laryngoscope blade acc. to Foregger, no. 2

Material: Stainless steel

Other Sizes:
010-0387-02 : 90 mm



Anaesthesia
Laryngoscope blade acc. to Foregger, no. 3

Material: Stainless steel

Other Sizes:
010-0387-03 : 110 mm



Anaesthesia
Laryngoscope blade acc. to Foregger, no. 4

Material: Stainless steel

Other Sizes:
010-0387-04 : 135 mm



Anaesthesia
Laryngoscope set, acc. to Foregger

Material: Stainless steel

Other Sizes:
010-0390-00 : ...



Anaesthesia
Laryngoscope set, acc. to Foregger

Material: Stainless steel

Other Sizes:
010-0391-00 : ...
010-0398-00 : ...



Anaesthesia
Battery Handle for laryngoscope

Material: Stainless steel

Other Sizes:
010-0392-00 ...



Anaesthesia
Spare bulb, large

Material: Stainless steel

Other Sizes:
010-0395-00 ...

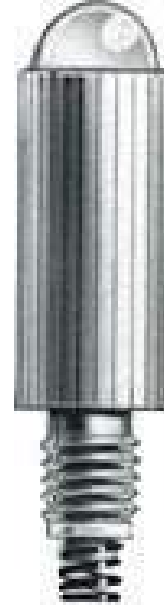

Anaesthesia
Spare bulb, small

Material: Stainless steel

Other Sizes:
010-0395-01



Anaesthesia
Storage case, for 3 straight laryngoscope blades

Material: all other, not specially marked arial types

Other Sizes:
010-0398-01 ...



Anaesthesia
Storage case, for 4 straight laryngoscope blades

Material: all other, not specially marked arial types

Other Sizes:
010-0398-02 ...



Anaesthesia
Storage case, for 3 curved laryngoscope blades

Material: all other, not specially marked arial types

Other Sizes:
010-0398-03 ...



Anaesthesia

Storage case, for 4 curved laryngoscope blades

Material: Stainless steel

Other Sizes:

010-0398-04 : ...



Anaesthesia

Fiber optic laryngoscope set, acc. to McIntosh, battery

Material: Stainless steel

Other Sizes:

010-0500-00 : ...
 010-0505-00 : ...
 010-0510-00 : ...
 010-0515-00 : ...



Anaesthesia

Fiber optic laryngoscope blade, acc. to McIntosh, no. 0

Material: Stainless steel

Other Sizes:

010-0520-00 : 55 mm



Anaesthesia

Fiber optic laryngoscope blade, acc. to McIntosh, no. 1

Material: Stainless steel

Other Sizes:

010-0520-01 : 70 mm



Anaesthesia

Fiber optic laryngoscope blade, acc. to McIntosh, no. 2

Material: Stainless steel

Other Sizes:

010-0520-02 : 80 mm



Anaesthesia

Fiber optic laryngoscope blade, acc. to McIntosh, no. 3

Material: Stainless steel

Other Sizes:

010-0520-03 : 105 mm



Anaesthesia

Fiber optic laryngoscope blade, acc. to McIntosh, no. 4

Material: Stainless steel

Other Sizes:

010-0520-04 : 130 mm



Anaesthesia

Fiber optic laryngoscope set, acc. to Foregger, battery

Material: Stainless steel

Other Sizes:

010-0540-00 : ...
010-0545-00 : ...
010-0550-00 : ...
010-0555-00 : ...



Anaesthesia

Fiber optic laryngoscope blade, acc. to Foregger, no. 0

Material: Stainless steel

Other Sizes:

010-0560-00 : 55 mm



Anaesthesia

Fiber optic laryngoscope blade, acc. to Foregger, no. 1

Material: Stainless steel

Other Sizes:

010-0560-01 : 70 mm



Anaesthesia

Fiber optic laryngoscope blade, acc. to Foregger, no. 2

Material: Stainless steel

Other Sizes:

010-0560-02 : 90 mm



Anaesthesia

Fiber optic laryngoscope blade, acc. to Foregger, no. 3

Material: Stainless steel

Other Sizes:

010-0560-03 : 110 mm



Anaesthesia

Fiber optic laryngoscope blade, acc. to Foregger, no. 4

Material: Stainless steel

Other Sizes:

010-0560-04 : 135 mm



Anaesthesia

Fiber optic laryngoscope blade, acc. to Miller, no. 0

Material: Stainless steel

Other Sizes:

010-0585-00 : 55 mm



Anaesthesia

Fiber optic laryngoscope blade, acc. to Miller, no. 2

Material: Stainless steel

Other Sizes:

010-0585-02 : 130 mm



Anaesthesia

Fiber optic laryngoscope set, acc. to Miller, battery

Material: Stainless steel

Other Sizes:

010-0565-00 : ...
010-0570-00 : ...
010-0575-00 : ...
010-0580-00 : ...



Anaesthesia

Fiber optic laryngoscope blade, acc. to Miller, no. 1

Material: Stainless steel

Other Sizes:

010-0585-01 : 80 mm



Anaesthesia

Fiber optic laryngoscope blade, acc. to Miller, no. 3

Material: Stainless steel

Other Sizes:

010-0585-03 : 170 mm



Anaesthesia

Fiber optic laryngoscope blade, acc. to Miller, no. 4

Material: Stainless steel

Other Sizes:
010-0585-04 : 180 mm



Anaesthesia

Battery Handle, with battery container

Material: Stainless steel

Other Sizes:
010-0600-00 : N/A



Anaesthesia

Battery container, for 010-0600-00

Material: all other, not specially marked material types

Other Sizes:
010-0604-00 : N/A



Anaesthesia

Handle, with inductive accumulator

Material: chrome-plated

Other Sizes:
010-0606-00 : N/A



Anaesthesia

Handle, with inductive accumulator, slim

Material: chrome-plated

Other Sizes:
010-0607-00 : N/A



Anaesthesia

Inductive accumulator, for 010-0606-00

Material: all other, not specially marked material types

Other Sizes:
010-0610-00 : N/A



Anaesthesia
Inductive accumulator, slim, for 010-0607-00

Material: all other, not specially marked material types

Other Sizes:
010-0611-00 N/A



Anaesthesia
Battery Handle, with battery container, slim

Material: chrome-plated

Other Sizes:
010-0615-00 N/A



Anaesthesia
Inductive Charger unit, for laryngoscopes

Material: all other, not specially marked material types

Other Sizes:
010-0620-00 N/A



Anaesthesia
Battery container, slim, for 010-0615-00

Material: all other, not specially marked material types

Other Sizes:
010-00625-00 N/A



Anaesthesia
Krypton bulb, 2.5 V

Material: all other, not specially marked material types

Other Sizes:
010-0640-00 N/A



Anaesthesia
Xenon bulb, 2.5 V

Material: all other, not specially marked material types

Other Sizes:
010-0645-00 N/A



Diagnostics

N/A

Material: Stainless steel

Other Sizes:

008-0155-18 : 18.5 cm



Diagnostics

N/A

Material: Stainless steel

Other Sizes:

008-0156-18 : 20 cm



Diagnostics

N/A

Material: Stainless steel

Other Sizes:

008-0184-20 : 20 cm



Diagnostics

N/A

Material: Stainless steel

Other Sizes:

008-0185-21 : 21 cm



Diagnostics

N/A

Material: Stainless steel

Other Sizes:

008-0190-20 : 20 cm



Diagnostics

N/A

Material: Stainless steel

Other Sizes:

008-0210-19 : 18 cm

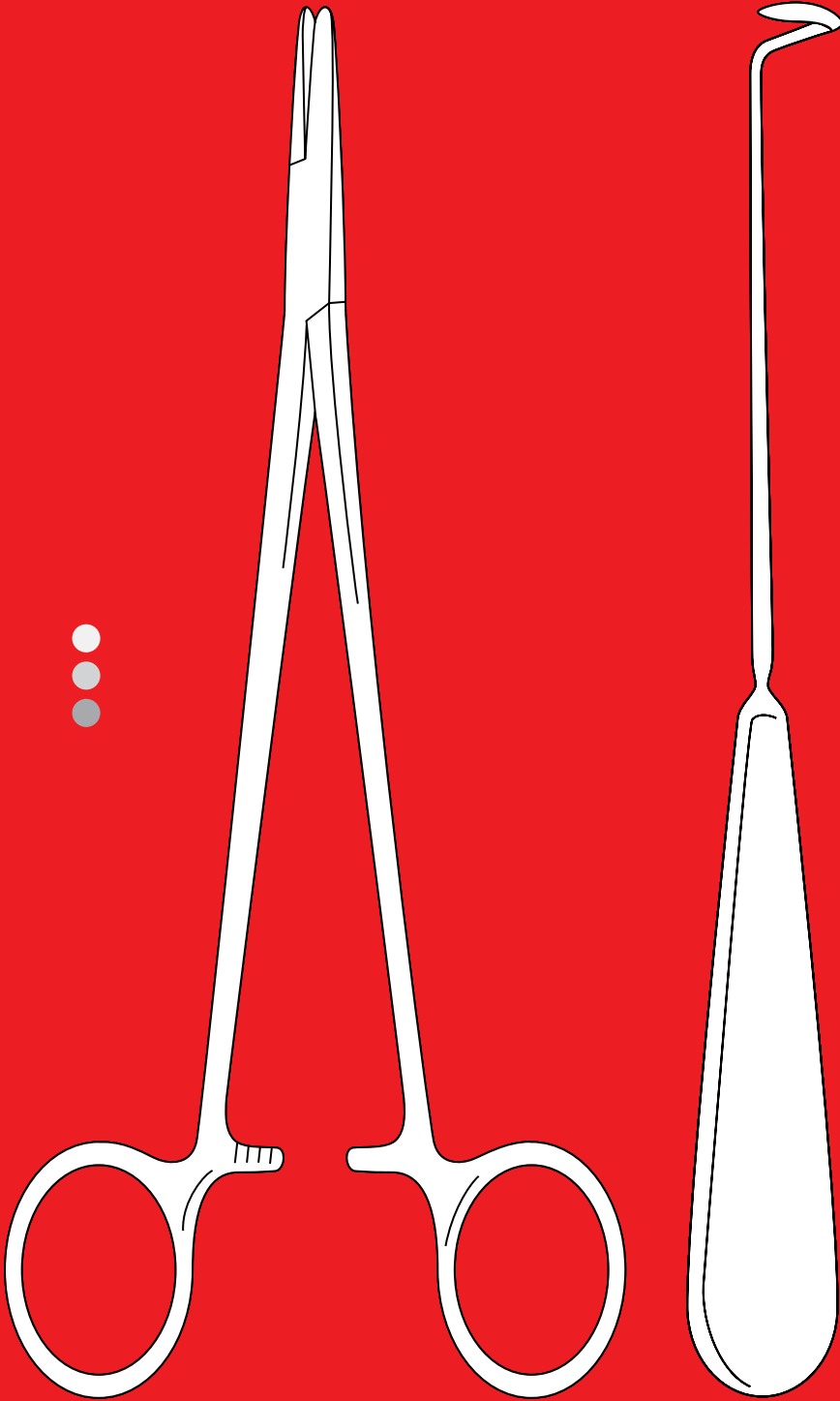

SUTURE

— RANGE

DISCOVER NOW

“Instruments for
surgical procedures”
Since 1970

SUTURE



Suture
Micro needleholder, straight, without lock

Material: Stainless steel

Other Sizes:
011-0000-00 : 15 cm



Suture
Micro needleholder, straight, with lock, 15 cm

Material: Stainless steel

Other Sizes:
011-0000-01 : 15 cm



Suture
Micro needleholder, straight, without lock

Material: Stainless steel

Other Sizes:
011-0000-02 : 15 cm



Suture
Micro needleholder, straight, with lock

Material: Stainless steel

Other Sizes:
011-0000-03 : 15 cm



Suture
Micro needleholder, curved, without lock

Material: Stainless steel

Other Sizes:
011-0001-00 : 15 cm



Suture
Micro needleholder, curved, with lock, 15 cm

Material: Stainless steel

Other Sizes:
011-0001-01 : 15 cm

SUTURE



Suture
Micro needleholder, curved, without lock

Material: Stainless steel

Other Sizes:
011-0001-02 : 15 cm



Suture
Micro needleholder, curved, with lock

Material: Stainless steel

Other Sizes:
011-0001-03 : 15 cm



Suture
Micro needleholder, straight, with lock

Material: Stainless steel

Other Sizes:
011-0002-15 : 15 cm
011-0002-18 : 18 cm



Suture
Micro needleholder, curved, with lock

Material: Stainless steel

Other Sizes:
011-0003-15 : 15 cm
011-0003-18 : 18 cm



Suture
Micro needleholder, straight, without lock

Material: Stainless steel

Other Sizes:
011-0004-15 : 15 cm
011-0004-18 : 18 cm



Suture
Micro needleholder, curved, without lock

Material: Stainless steel

Other Sizes:
011-0005-15 : 15 cm
011-0005-18 : 18 cm

SUTURE



Suture
Micro needleholder, straight, with lock

Material: Stainless steel

Other Sizes:
011-0006-18 : 18 cm



Suture
Micro needleholder, curved, with lock

Material: Stainless steel

Other Sizes:
011-0007-18 : 18 cm



Suture
Micro needleholder, straight, without lock

Material: Stainless steel

Other Sizes:
011-0008-18 : 18 cm



Suture
Micro needleholder, curved, without lock

Material: Stainless steel

Other Sizes:
011-0009-18 : 18 cm



Suture
Micro needleholder, straight, with lock

Material: Stainless steel

Other Sizes:
011-0010-15 : 15 cm
011-0010-18 : 18 cm
011-0010-21 : 21 cm
011-0010-23 : 23 cm
011-0010-25 : 25 cm



Suture
Micro needleholder, curved, with lock

Material: Stainless steel

Other Sizes:
011-0011-15 : 15 cm
011-0011-18 : 18 cm
011-0011-21 : 21 cm
011-0011-23 : 23 cm
011-0011-25 : 25 cm

SUTURE



Suture
Micro needleholder, straight, without lock

Material: Stainless steel

Other Sizes:

011-0012-15	15 cm
011-0012-18	18 cm
011-0012-21	21 cm
011-0012-23	23 cm
011-0012-25	25 cm



Suture
Micro needleholder, curved, without lock

Material: Stainless steel

Other Sizes:

011-0013-15	15 cm
011-0013-18	18 cm
011-0013-21	21 cm
011-0013-23	23 cm
011-0013-25	25 cm



Suture
Ti micro needleholder, straight, with lock

Material: Stainless steel

Other Sizes:

011-0016-15	15 cm
011-0016-18	18 cm



Suture
Ti micro needleholder, curved, with lock

Material: Stainless steel

Other Sizes:

011-0017-15	15 cm
011-0017-18	18 cm



Suture
Ti micro needleholder, straight, without lock

Material: Stainless steel

Other Sizes:

011-0018-15	15 cm
011-0018-18	18 cm



Suture
Ti micro needleholder, curved, without lock

Material: Stainless steel

Other Sizes:

011-0019-15	15 cm
011-0019-18	18 cm

SUTURE



Suture

Ti micro needleholder, straight, with lock

Material: Stainless steel

Other Sizes:

011-0020-15	15 cm
011-0020-18	18 cm
011-0020-21	21 cm
011-0020-23	23 cm
011-0020-25	25 cm



Suture

Ti micro needleholder, curved, with lock

Material: Stainless steel

Other Sizes:

011-0021-15	15 cm
011-0021-18	18 cm
011-0021-21	21 cm
011-0021-23	23 cm
011-0021-25	25 cm



Suture

Ti micro needleholder, straight, without lock

Material: Stainless steel

Other Sizes:

011-0022-15	15 cm
011-0022-18	18 cm
011-0022-21	21 cm
011-0022-23	23 cm
011-0022-25	25 cm



Suture

Ti micro needleholder, curved, without lock

Material: Stainless steel

Other Sizes:

011-0023-15	15 cm
011-0023-18	18 cm
011-0023-21	21 cm
011-0023-23	23 cm
011-0023-25	25 cm



Suture

Micro needleholder, straight, with lock, 1.2 mm

Material: stainless steel

Other Sizes:

011-0030-15	15 cm
011-0030-18	18 cm
011-0030-21	21 cm
011-0030-23	23 cm
011-0030-25	25 cm



Suture

Micro needleholder, curved, with lock, 1.2 mm

Material: stainless steel

Other Sizes:

011-0031-15	15 cm
011-0031-18	18 cm
011-0031-21	21 cm
011-0031-23	23 cm
011-0031-25	25 cm

SUTURE



Suture
Micro needleholder, straight, without lock, 1.2 mm

Material: Stainless steel

Other Sizes:

011-0032-15	15 cm
011-0032-18	18 cm
011-0032-21	21 cm
011-0032-23	23 cm
011-0032-25	25 cm



Suture
Micro needleholder, curved, without lock

Material: Stainless steel

Other Sizes:

011-0033-15	15 cm
011-0033-18	18 cm
011-0033-21	21 cm
011-0033-23	23 cm
011-0033-25	25 cm



Suture
Micro needleholder, straight, with lock, 0.8 mm

Material: Stainless steel

Other Sizes:

011-0060-15	15 cm
011-0060-18	18 cm
011-0060-21	21 cm
011-0060-23	23 cm



Suture
Micro needleholder, curved, with lock, 0.8 mm

Material: Stainless steel

Other Sizes:

011-0061-15	15 cm
011-0061-18	18 cm
011-0061-21	21 cm
011-0061-23	23 cm



Suture
Micro needleholder, straight, without lock, 0.8 mm

Material: Stainless steel

Other Sizes:

011-0062-15	15 cm
011-0062-18	18 cm
011-0062-21	21 cm
011-0062-23	23 cm



Suture
Micro needleholder, curved, without lock, 0.8 mm

Material: Stainless steel

Other Sizes:

011-0063-15	15 cm
011-0063-18	18 cm
011-0063-21	21 cm
011-0063-23	23 cm

SUTURE



Suture
Micro needleholder, straight, with lock, 1.2 mm

Material: Stainless steel

Other Sizes:

011-0070-15	15 cm
011-0070-18	18 cm
011-0070-21	21 cm
011-0070-23	23 cm



Suture
Micro needleholder, curved, with lock, 1.2 mm

Material: Stainless steel

Other Sizes:

011-0071-15	15 cm
011-0071-18	18 cm
011-0071-21	21 cm
011-0071-23	23 cm



Suture
Micro needleholder, straight, without lock, 1.2 mm

Material: Stainless steel

Other Sizes:

011-0072-15	15 cm
011-0072-18	18 cm
011-0072-21	21 cm
011-0072-23	23 cm



Suture
Micro needleholder, curved, without lock, 1.2 mm

Material: Stainless steel

Other Sizes:

011-0073-15	15 cm
011-0073-18	18 cm
011-0073-21	21 cm
011-0073-23	23 cm



Suture
Needleholder, acc. to Kalt, straight

Material: Stainless steel

Other Sizes:

011-0274-14	13.5 cm
-------------	---------



Suture
Needleholder, acc. to Barraquer, straight

Material: Stainless steel

Other Sizes:

011-0288-10	10 cm
-------------	-------

SUTURE



Suture

Surgical needle, G, 1/2 circle no.1 to 16

Material: all other, not specially marked material types

Other Sizes:

011-0123-01	N/A
011-0123-02	N/A
011-0123-03	N/A
011-0123-04	N/A
011-0123-05	N/A
011-0123-06	N/A
011-0123-07	N/A
011-0123-08	N/A
011-0123-09	N/A
011-0123-10	N/A
011-0123-11	N/A
011-0123-12	N/A
011-0123-13	N/A
011-0123-14	N/A
011-0123-15	N/A
011-0123-16	N/A



Suture

Surgical needle, GR, 1/2 circle

Material: all other, not specially marked material types

Other Sizes:

011-0127-01	N/A
011-0127-02	N/A
011-0127-03	N/A
011-0127-04	N/A
011-0127-05	N/A
011-0127-06	N/A
011-0127-07	N/A
011-0127-08	N/A
011-0127-09	N/A
011-0127-10	N/A
011-0127-11	N/A
011-0127-12	N/A
011-0127-13	N/A
011-0127-14	N/A
011-0127-15	N/A
011-0127-16	N/A



Suture

Surgical needle, GA, 1/2 circle

Material: all other, not specially marked material types

Other Sizes:

011-0133-01	N/A
011-0133-02	N/A
011-0133-03	N/A
011-0133-04	N/A
011-0133-05	N/A
011-0133-06	N/A
011-0133-07	N/A
011-0133-08	N/A
011-0133-09	N/A

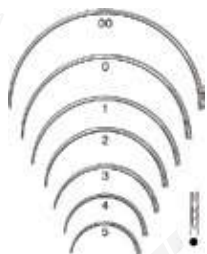

Suture

Surgical needle, PB, 1/2 circle, no. 0

Material: all other, not specially marked material types

Other Sizes:

011-0175-10	N/A
011-0175-20	N/A
011-0175-01	N/A
011-0175-02	N/A
011-0175-03	N/A
011-0175-04	N/A
011-0175-05	N/A

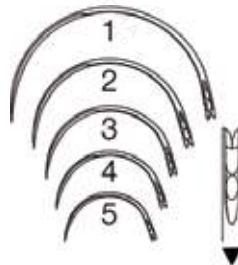

Suture

Eye needle, OG, 1/2 circle, no. 1

Material: all other, not specially marked material types

Other Sizes:

011-0209-01	N/A
011-0209-02	N/A
011-0209-03	N/A
011-0209-04	N/A
011-0209-05	N/A

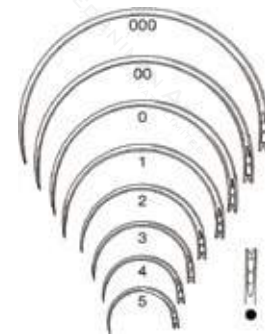

Suture

Surgical needle, E, 1/2 circle

Material: all other, not specially marked material types

Other Sizes:

011-0154-10	N/A
011-0154-20	N/A
011-0154-30	N/A
011-0155-01	N/A
011-0155-02	N/A
011-0155-03	N/A
011-0155-04	N/A
011-0155-05	N/A

SUTURE



Suture
Needleholder, acc. to Barraquer, curved

Material: Stainless steel

Other Sizes:
011-0289-10 10.5 cm



Suture
Needleholder, acc. to Arruga, straight

Material: Stainless steel

Other Sizes:
011-0290-14 13.5 cm



Suture
Needleholder, acc. to Arruga, curved

Material: Stainless steel

Other Sizes:
011-0291-14 13.5 cm



Suture
Micro needleholder, acc. to Barraquer-Trautmann, straight, with lock

Material: Stainless steel

Other Sizes:
011-0298-10 10.5 cm
011-0298-11 11.5 cm



Suture
Micro needleholder, acc. to Barraquer-Trautmann, curved, with lock

Material: Stainless steel

Other Sizes:
011-0299-10 10.5 cm
011-0299-11 11.5 cm



Suture
Micro needleholder, acc. to Barraquer, curved, without lock

Material: Stainless steel

Other Sizes:
011-0300-11 11.5 cm

SUTURE



Suture
Micro needleholder, acc. to Barraquer,
curved, with lock

Material: Stainless steel

Other Sizes:
011-0300-13 : 13 cm
011-0300-14 : 14 cm



Suture
Micro needleholder, acc. to Barraquer,
curved, with lock

Material: Stainless steel

Other Sizes:
011-0301-13 : 13.5 cm



Suture
Micro needleholder, acc. to Barraquer,
straight, very delicate jaw, without lock

Material: Stainless steel

Other Sizes:
011-0302-01 : 13 cm



Suture
Micro needleholder, acc. to Castroviejo-
Fino, without lock, curved

Material: Stainless steel

Other Sizes:
011-0303-01 : 13 cm



Suture
Micro needleholder, acc. to Castroviejo-
Fino, without lock, curved

Material: Stainless steel

Other Sizes:
011-0303-09 : 9 cm



Suture
Needleholder, delicated, straight,
with lock

Material: Stainless steel

Other Sizes:
011-0304-01 : 13 cm

SUTURE



Suture
Needleholder, acc. to Castroviejo,
straight, with lock

Material: Stainless steel

Other Sizes:
011-0304-09 : 9 cm



Suture
Needleholder, delicate, curved, with lock

Material: Stainless steel

Other Sizes:
011-0305-01 : 13 cm



Suture
Needleholder, acc. to Castroviejo,
curved, with lock

Material: Stainless steel

Other Sizes:
011-0305-09 : 9 cm



Suture
Micro needleholder, straight, with lock

Material: Stainless steel

Other Sizes:
011-0306-14 : 14 cm



Suture
Micro needleholder, curved, with lock

Material: Stainless steel

Other Sizes:
011-0307-14 : 14 cm



Suture
Micro needleholder, straight, without lock

Material: Stainless steel

Other Sizes:
011-0308-14 : 14 cm

SUTURE



Suture
Micro needleholder, curved, without lock

Material: Stainless steel

Other Sizes:
011-0309-14 : 14 cm



Suture
Micro needleholder, straight, with lock

Material: Stainless steel

Other Sizes:
011-0310-14 : 14 cm



Suture
Micro needleholder, curved, with lock

Material: Stainless steel

Other Sizes:
011-0311-14 : 14 cm



Suture
Micro needleholder, curved, without lock

Material: Stainless steel

Other Sizes:
011-0313-14 : 14 cm



Suture
Needleholder, acc. to Arruga, straight

Material: Stainless steel

Other Sizes:
011-0314-16 : 16 cm



Suture
Needleholder, acc. to Arruga, curved

Material: Stainless steel

Other Sizes:
011-0315-16 : 16 cm

SUTURE



Suture
Micro needleholder, straight, with lock

Material: Stainless steel

Other Sizes:
011-0316-13 : 12 cm



Suture
Micro needleholder, curved, with lock

Material: Stainless steel

Other Sizes:
011-0317-12 : 12 cm



Suture
Needleholder, acc. to Derf, grooved

Material: Stainless steel

Other Sizes:
011-0326-12 : 12 cm



Suture
Needleholder, acc. to Derf, longitudinal serration

Material: Stainless steel

Other Sizes:
011-0328-12 : 13 cm



Suture
Needleholder, acc. to Collier, grooved

Material: Stainless steel

Other Sizes:
011-0332-12 : 12.5 cm



Suture
Needleholder, acc. to Webster, smooth

Material: Stainless steel

Other Sizes:
011-0334-13 : 13 cm

SUTURE



Suture
Needleholder, acc. to Halsey, smooth

Material: Stainless steel

Other Sizes:
011-0336-13 : 13.5 cm



Suture
Needleholder, acc. to Neivert, grooved

Material: Stainless steel

Other Sizes:
011-0338-13 : 12.5 cm



Suture
Needleholder, acc. to acc. to Hegar-Baumgartner

Material: Stainless steel

Other Sizes:
011-0340-14 : 14.5 cm



Suture
Needleholder, acc. to Brown, heavy

Material: Stainless steel

Other Sizes:
011-0344-13 : 13 cm
011-0344-18 : 18 cm



Suture
Needleholder, acc. to Crile-Murray, slim

Material: Stainless steel

Other Sizes:
011-0348-15 : 15 cm



Suture
Needleholder, acc. to Crile-Wood, grooved

Material: Stainless steel

Other Sizes:
011-0350-15 : 15 cm

SUTURE



Suture
Needleholder, acc. to Adson, fenestrated

Material: Stainless steel

Other Sizes:
011-0360-18 : 18 cm



Suture
Needleholder, acc. to Metzenbaum, fenestrated

Material: Stainless steel

Other Sizes:
011-0364-18 : 18.5 cm



Suture
Needleholder, M. G. Hospital style

Material: Stainless steel

Other Sizes:
011-0384-17 : 17.5 cm



Suture
Needleholder, acc. to Mayo-acc. to Hegar

Material: Stainless steel

Other Sizes:
011-0390-14 : 14.5 cm
011-0390-16 : 16 cm
011-0390-18 : 18.5 cm
011-0390-20 : 20.5 cm
011-0390-24 : 24 cm
011-0390-26 : 26.5 cm



Suture
Needleholder, acc. to Mayo-acc. to Hegar, slim

Material: Stainless steel

Other Sizes:
011-0396-16 : 16 cm
011-0396-18 : 18.5 cm
011-0396-20 : 20.5 cm



Suture
Needleholder, acc. to Heany, curved

Material: Stainless steel

Other Sizes:
011-0403-21 : 20.5 cm

SUTURE



Suture
Needleholder, acc. to Jamison, slim

Material: Stainless steel

Other Sizes:
011-0404-23 : 23.5 cm



Suture
Needleholder, acc. to Masson, heavy

Material: Stainless steel

Other Sizes:
011-0408-27 : 26.5 cm



Suture
Needleholder, acc. to FinoChietto, angled

Material: Stainless steel

Other Sizes:
011-0415-27 : 26.5 cm



Suture
Needleholder, acc. to Wangenstein

Material: Stainless steel

Other Sizes:
011-0420-27 : 26.5 cm



Suture
Needleholder, acc. to Johnson, curved

Material: Stainless steel

Other Sizes:
011-0437-27 : 27 cm



Suture
Needleholder, acc. to Stratte, curved

Material: Stainless steel

Other Sizes:
011-0451-23 : 23 cm

SUTURE



Suture
Needleholder, acc. to Olsen-acc.
to Hegarr, straight

Material: Stainless steel

Other Sizes:
011-0466-14 14 cm



Suture
Needleholder, acc. to acc. to Gillies

Material: Stainless steel

Other Sizes:
011-0469-16 16 cm



Suture
Needleholder, acc. to Crile

Material: Stainless steel

Other Sizes:
011-0500-15 15 cm



Suture
Needleholder, acc. to Mathieu

Material: Stainless steel

Other Sizes:
011-0516-14 14 cm
011-0516-17 17 cm
011-0516-20 20 cm



Suture
Needleholder, acc. to Mathieu, slim

Material: Stainless steel

Other Sizes:
011-0526-14 14 cm
011-0526-17 16.5 cm



Suture
Needleholder, acc. to Toennis

Material: Stainless steel

Other Sizes:
011-0574-18 18.5 cm

SUTURE



Suture
Needleholder, acc. to LiChthenberg, light

Material: Stainless steel

Other Sizes:
011-0576-20 : 20 cm



Suture
Micro needleholder, bayonet-shape, curved

Material: Stainless steel

Other Sizes:
011-0589-16 : 16 cm



Suture
Micro needleholder, bayonet-shape, straight

Material: Stainless steel

Other Sizes:
011-0592-23 : 23 cm



Suture
Micro needleholder, bayonet-shape, curved

Material: Stainless steel

Other Sizes:
011-0593-23 : 23 cm



Suture
Micro needleholder, bayonet-shape, curved

Material: Stainless steel

Other Sizes:
011-0595-19 : 19 cm



Suture
TC Micro needleholder, acc. to Hepp-Scheidel, round Handle

Material: Stainless steel

Other Sizes:
011-0602-18 : 18 cm

SUTURE



Suture
TC needleholder, acc.to Webster

Material: Stainless steel

Other Sizes:
011-0604-13 : 13 cm



Suture
TC needleholder, acc. to Crile-Wood

Material: Stainless steel

Other Sizes:
011-0604-15 : 15 cm



Suture
N/A

Material: Stainless steel

Other Sizes:
011-0605-15 : 15 cm
011-0605-18 : 18 cm
011-0605-21 : 21 cm
011-0605-23 : 23 cm
011-0605-25 : 25 cm



Suture
Micro needleholder, straight, with lock

Material: Stainless steel

Other Sizes:
011-060-15 : 15 cm
011-0606-18 : 18 cm
011-0606-21 : 21 cm
011-0606-23 : 23 cm
011-0606-25 : 25 cm



Suture
Micro needleholder, curved, without lock

Material: Stainless steel

Other Sizes:
011-0607-15 : 15 cm
011-0607-18 : 18 cm
011-0607-21 : 21 cm
011-0607-23 : 23 cm
011-0607-25 : 25 cm



Suture
Micro needleholder, straight, without lock

Material: Stainless steel

Other Sizes:
011-0608-15 : 15 cm
011-0608-18 : 18 cm
011-0608-21 : 21 cm
011-0608-23 : 23 cm
011-0608-25 : 25 cm

SUTURE



Suture
TC needleholder, acc. to Jaboma, with lock

Material: Stainless steel

Other Sizes:
011-0610-18 : 18 cm



Suture
Needleholder, acc. to Gregory

Material: Stainless steel

Other Sizes:
011-0612-18 : 18 cm
011-0612-21 : 21 cm



Suture
Micro needleholder, 10 mm, heavy duty

Material: Stainless steel

Other Sizes:
011-0613-19 : 19 cm
011-0613-23 : 23 cm
011-0613-25 : 25 cm



Suture
Micro needleholder, straight, without lock

Material: Stainless steel

Other Sizes:
011-0614-01 : 14.5 cm



Suture
Micro needleholder, straight, with lock

Material: Stainless steel

Other Sizes:
011-0614-02 : 14.5 cm



Suture
Micro needleholder, straight, without lock

Material: Stainless steel

Other Sizes:
011-0614-03 : 14,5 cm

SUTURE



011-0615-01

Suture
Micro needleholder, curved, without lock

Material: Stainless steel

Other Sizes:
011-0615-01 : 14.5 cm



011-0615-02

Suture
Micro needleholder, curved, with lock

Material: Stainless steel

Other Sizes:
011-0615-02 : 14.5 cm



011-0615-03

Suture
Micro needleholder, curved, without lock

Material: Stainless steel

Other Sizes:
011-0615-03 : 14.5 cm



Suture
Micro needleholder, curved, with lock

Material: Stainless steel

Other Sizes:
011-0615-04 : 14,5 cm



Suture
TC Micro needleholder, straight, with lock

Material: Stainless steel

Other Sizes:
011-0620-00 : 14.5 cm



Suture
TC Micro needleholder, curved, without lock

Material: Stainless steel

Other Sizes:
011-0620-01 : 14.5 cm

SUTURE



Suture
TC Micro needleholder, smooth

Material: Stainless steel

Other Sizes:
011-0620-14 : 14.5 cm



Suture
TC Micro needleholder, straight, with lock

Material: Stainless steel

Other Sizes:
011-0620-18 : 18 cm
20-620-21-22 : 22 cm



Suture
TC Micro needleholder, curved, smooth

Material: Stainless steel

Other Sizes:
011-0621-14 : 14.5 cm



Suture
TC Micro needleholder, curved, with lock

Material: Stainless steel

Other Sizes:
011-0621-18 : 18 cm
011-0621-21 : 22 cm



Suture
TC needleholder, acc. to Arruga, straight

Material: Stainless steel

Other Sizes:
011-0622-16 : 16 cm



Suture
TC needleholder, acc. to Arruga, curved

Material: Stainless steel

Other Sizes:
011-0623-16 : 16 cm

SUTURE



Suture
TC needleholder, acc. to Castroviejo straight

Material: Stainless steel

Other Sizes:
011-0624-13 : 12.5 cm



Suture
TC needleholder, acc. to Barraquer, with lock

Material: Stainless steel

Other Sizes:
011-0626-13 : 13 cm



Suture
TC needleholder, acc. to Barraquer, without lock

Material: Stainless steel

Other Sizes:
011-0628-13 : 13 cm



Suture
TC needleholder, acc. to Webster, smooth

Material: Stainless steel

Other Sizes:
011-0630-13 : 13 cm



Suture
TC needleholder, acc. to acc. to Kilner, bayonet-shape

Material: Stainless steel

Other Sizes:
011-0631-13 : 13 cm



Suture
TC needleholder, acc. to Derf

Material: Stainless steel

Other Sizes:
011-0632-12 : 12 cm

SUTURE



Suture
TC needleholder, acc. to acc. to Hegar-Baumgartner

Material: Stainless steel

Other Sizes:
011-0634-13 : 13 cm
011-0634-14 : 14.5 cm



Suture
TC needleholder, acc. to Halsey, smooth

Material: Stainless steel

Other Sizes:
011-0636-13 : 13 cm



Suture
TC needleholder, acc. to Webster, smooth

Material: Stainless steel

Other Sizes:
011-0637-12 : 12 cm



Suture
TC needleholder, acc. to Halsey

Material: Stainless steel

Other Sizes:
011-0637-13 : 13 cm



Suture
TC needleholder, acc. to Crile-Wood

Material: Stainless steel

Other Sizes:
011-0638-15 : 15 cm



Suture
TC needleholder, acc. to Crile-Wood

Material: Stainless steel

Other Sizes:
011-0638-20 : 20.5 cm

SUTURE



Suture
TC needleholder, acc. to Sarot

Material: Stainless steel

Other Sizes:

011-0640-20	20 cm
011-0640-18	18 cm
011-0640-26	26 cm



Suture
TC needleholder, acc. to Mayo-acc. to Hegar

Material: Stainless steel

Other Sizes:

011-0642-16	16 cm
011-0642-18	18 cm
011-0642-20	20 cm
011-0642-24	24 cm
011-0642-26	26 cm
011-0642-30	30 cm



Suture
TC needleholder, acc. to Heaney curved

Material: Stainless steel

Other Sizes:

011-0643-20	20 cm
011-0643-24	24 cm
011-0643-26	26 cm



Suture
TC needleholder, acc. to De Bakey

Material: Stainless steel

Other Sizes:

011-0646-18	18 cm
011-0646-20	20 cm
011-0646-23	23 cm
011-0646-26	26 cm
011-0646-31	31 cm



Suture
TC needleholder, acc. to Masson

Material: Stainless steel

Other Sizes:

011-0648-27	26.5 cm
-------------	---------



011-0650-13

Suture
TC needleholder, acc. to Ryder (Martin)

Material: Stainless steel

Other Sizes:

011-0650-13	12.5 cm
011-0650-15	15 cm
011-0650-18	18 cm
011-0650-20	20 cm
011-0650-23	23 cm
011-0650-26	26 cm

SUTURE



Suture
TC needleholder, Martin type

Material: Stainless steel

Other Sizes:

011-0652-15	15 cm
011-0652-17	17 cm
011-0652-20	20 cm



Suture
TC needleholder, acc. to FinoChietto

Material: Stainless steel

Other Sizes:

011-0653-27	26.5 cm
-------------	---------



Suture
TC needleholder, acc. to Ryder-Vascular

Material: Stainless steel

Other Sizes:

011-0654-13	12 cm
011-0654-15	15.5 cm
011-0654-18	17.5 cm
011-0654-20	20 cm
011-0654-23	22.5 cm
011-0654-26	26 cm



Suture
TC needleholder, acc. to Wangenstein

Material: Stainless steel

Other Sizes:

011-0656-27	27 cm
-------------	-------



Suture
TC needleholder, acc. to acc. to Hegar-Vascular

Material: Stainless steel

Other Sizes:

011-0658-14	14 cm
011-0658-18	18.5 cm
011-0658-20	20.5 cm
011-0658-23	23 cm



Suture
TC needleholder, acc. to Bozemann, s-shape

Material: Stainless steel

Other Sizes:

011-0659-20	20.5 cm
011-0659-24	24 cm
011-0659-26	26.5 cm
011-0659-28	29 cm

SUTURE



Suture
TC needleholder, acc. to acc. to Hegar

Material: Stainless steel

Other Sizes:
011-0662-20 : 20 cm
011-0662-24 : 23.5 cm



Suture
TC needleholder, acc. to Stratte, slim

Material: Stainless steel

Other Sizes:
011-0665-22 : 23 cm



Suture
TC needleholder, acc. to Stratte, curved

Material: Stainless steel

Other Sizes:
011-0665-23 : 23 cm



Suture
TC needleholder, micro vascular

Material: Stainless steel

Other Sizes:
011-0666-00 : 14 cm
011-0666-02 : 17.5 cm
011-0666-03 : 20 cm
011-0666-04 : 23 cm
011-0666-05 : 26 cm



Suture
TC needleholder, acc. to Martini, smooth

Material: Stainless steel

Other Sizes:
011-0668-00 : 14 cm
011-0668-01 : 15 cm
011-0668-02 : 17.5 cm
011-0668-03 : 20 cm



Suture
TC needleholder, acc. to Martini

Material: Stainless steel

Other Sizes:
011-0670-00 : 14 cm
011-0670-01 : 15 cm
011-0670-02 : 17.5 cm
011-0670-03 : 20 cm

SUTURE



Suture
TC needleholder, acc. to Olson-acc. to Hegar

Material: Stainless steel

Other Sizes:
011-0672-14 : 14.5 cm
011-0672-17 : 17 cm
011-0672-18 : 19 cm



Suture
TC needleholder, acc. to Foster-acc. to Gillies

Material: Stainless steel

Other Sizes:
011-0673-12 : 11 cm



Suture
TC needleholder, acc. to acc. to Gillies-Mini

Material: Stainless steel

Other Sizes:
011-0673-15 : 15 cm



Suture
TC needleholder, acc. to acc. to Gillies

Material: Stainless steel

Other Sizes:
011-0673-16 : 16 cm



Suture
TC needleholder, acc. to Mathieu, slim

Material: Stainless steel

Other Sizes:
011-0674-14 : 14 cm
011-0674-17 : 17 cm
011-0674-20 : 20 cm



Suture
TC needleholder, acc. to Mathieu

Material: Stainless steel

Other Sizes:
011-0676-14 : 14 cm
011-0676-17 : 17 cm
011-0676-20 : 20 cm

SUTURE



Suture
TC needleholder, acc. to Mathieu

Material: Stainless steel

Other Sizes:

011-0678-17	17 cm
011-0678-20	20 cm
011-0678-23	23 cm



Suture
TC needleholder, acc. to Toennis

Material: Stainless steel

Other Sizes:

011-0684-18	18.5 cm
-------------	---------



Suture
TC needleholder, acc. LiChTenberg

Material: Stainless steel

Other Sizes:

011-0686-20	20 cm
-------------	-------



Suture
TC needleholder, acc. to Langenbeck

Material: Stainless steel

Other Sizes:

011-0692-18	18 cm
011-0692-20	20.5 cm
011-0692-23	23 cm



Suture
TC needleholder, acc. to Zweifel

Material: Stainless steel

Other Sizes:

011-0696-20	20.5 cm
011-0696-23	23 cm



Suture
Needle, acc. to Reverdin

Material: Stainless steel

Other Sizes:

011-0701-15	14.5 cm
011-0721-15	20 cm
011-0741-15	23 cm

SUTURE



Suture
Needle, acc. to Reverdin, no. 1, short

Material: Stainless steel

Other Sizes:
011-0702-15 : 14.5 cm
011-0722-15 : 20 cm
011-0742-15 : 23 cm



Suture
Needle, acc. to Reverdin, no. 3, short

Material: Stainless steel

Other Sizes:
011-0703-15 : 14.5 cm
011-0723-15 : 20 cm
011-0743-15 : 23 cm



Suture
Needle, acc. to Reverdin, no. 4, short

Material: Stainless steel

Other Sizes:
011-0704-15 : 14.5 cm
011-0724-15 : 20 cm
011-0744-15 : 23 cm



Suture
Ligature needle, SCHMIDEN-DICK

Material: Stainless steel

Other Sizes:
011-0813-32 : 30 cm



Suture
Ligature needle, SCHMIDEN

Material: Stainless steel

Other Sizes:
011-0815-21 : 24 cm



Suture
Ligature needle, straight, malleable

Material: Stainless steel

Other Sizes:
011-0825-20 : 20 cm

SUTURE



Suture
Ligature needle, COOPER

Material: Stainless steel

Other Sizes:
011-0832-19 : 20 cm



Suture
Ligature needle, KRONECKER, right

Material: Stainless steel

Other Sizes:
011-0835-13 : 12 cm



Suture
Ligature needle, KRONECKER, left

Material: Stainless steel

Other Sizes:
011-0837-13 : 12 cm



Suture
Ligature needle, acc. to DesChamps, right

Material: Stainless steel

Other Sizes:
011-0839-24 : 24 cm



Suture
Ligature needle, acc. to DesChamps, left

Material: Stainless steel

Other Sizes:
011-0840-24 : 24 cm



Suture
Ligature needle, acc. to DesChamps, blunt, right

Material: Stainless steel

Other Sizes:
011-0841-20 : 20 cm

SUTURE



Suture

Ligature needle, acc. to DesChamps, blunt, left

Material: Stainless steel

Other Sizes:

011-0842-20 20 cm



Suture

Ligature needle, acc. to DesChamps, sharp

Material: Stainless steel

Other Sizes:

011-0847-21 20 cm
011-0848-21 20 cm



Suture

Ligature needle, acc. to DesChamps, blunt

Material: Stainless steel

Other Sizes:

011-0849-27 27 cm
011-0850-27 27 cm



Suture

Ligature needle, acc. to DesChamps, sharp

Material: Stainless steel

Other Sizes:

011-0851-27 27 cm
011-0852-27 27 cm



Suture

Ligature needle, acc. to DesChamps, blunt

Material: Stainless steel

Other Sizes:

011-0853-28 28 cm
011-0854-28 28 cm



Suture

Ligature needle, acc. to DesChamps, sharp

Material: Stainless steel

Other Sizes:

011-0855-20 21 cm
011-0856-20 21 cm

SUTURE



Suture
Ligature needle, acc. to DesChamps,
blunt

Material: Stainless steel

Other Sizes:

011-0857-20 21 cm
011-0858-20 21 cm



Suture
Ligature needle, acc. to DesChamps,
blunt

Material: Stainless steel

Other Sizes:

011-0859-20 21 cm
011-0860-20 21 cm



Suture
Ligature needle, acc. to acc. to
Brunner, no. 1

Material: Stainless steel

Other Sizes:

011-0861-30 30 cm



Suture
Ligature needle, acc. to acc. to
Brunner, no. 2

Material: Stainless steel

Other Sizes:

011-0862-30 30 cm



Suture
Grooved director, acc. to acc. to
Brunner, no. 1

Material: Stainless steel

Other Sizes:

011-0863-30 30 cm



Suture
Grooved director, acc. to acc. to
Brunner, no. 2

Material: Stainless steel

Other Sizes:

011-0864-30 30 cm

SUTURE



Suture
Grooved director, acc. to KirsChner

Material: Stainless steel

Other Sizes:
011-0865-25 25.5 cm



Suture
Grooved director

Material: Stainless steel

Other Sizes:
011-0866-28 28 cm



Suture
Hernia director, Martin type

Material: Stainless steel

Other Sizes:
011-0867-25 19.5 cm



Suture
N/A

Material: Stainless steel

Other Sizes:
011-0868-18 18 cm



Suture
N/A

Material: Stainless steel

Other Sizes:
011-0869-27 27 cm



Suture
N/A

Material: Stainless steel

Other Sizes:
011-0870-01 19 cm

SUTURE



Suture
N/A

Material: Stainless steel

Other Sizes:
011-0870-19 : 18.5 cm



Suture
Grooved director, acc. to Schmieden

Material: Stainless steel

Other Sizes:
011-0871-19 : 18 cm



Suture
Grooved director, acc. to Schmieden-
acc. to Payr

Material: Stainless steel

Other Sizes:
011-0872-19 : 18 cm



Suture
Grooved director, acc. to Koenig, no. 1

Material: Stainless steel

Other Sizes:
011-0875-03 : 19.5 cm



Suture
Grooved director, acc. to Koenig, no. 2

Material: Stainless steel

Other Sizes:
011-0875-05 : 19.5 cm



Suture
Grooved director, acc. to Koenig, no. 3

Material: Stainless steel

Other Sizes:
011-0875-07 : 19.5 cm

SUTURE



Suture
Grooved director, acc. to acc. to Payr,
curved

Material: Stainless steel

Other Sizes:
011-0877-22 : 22 cm



Suture
Grooved director, acc. to acc.
to Payr, straight

Material: Stainless steel

Other Sizes:
011-0878-22 : 22 cm



Suture
Ligature Catcher, Vienna-type

Material: Stainless steel

Other Sizes:
011-0882-23 : 23.5 cm



Suture
Knot tier, acc. to Bozemann

Material: Stainless steel

Other Sizes:
011-0884-21 : 22 cm



Suture
Ligature fork

Material: Stainless steel

Other Sizes:
011-0886-23 : 23 cm



Suture
Wound edge forceps, acc. to Childe,
with clip rack

Material: Stainless steel

Other Sizes:
011-0910-18 : 17 cm

SUTURE



Suture
Clip applying forceps, acc. to Hegembarth

Material: Stainless steel

Other Sizes:
011-0922-12 : 12 cm



Suture
Clip applying forceps, acc. to WaChenfeldt

Material: Stainless steel

Other Sizes:
011-0924-12 : 12 cm



Suture
Clip applying forceps, acc. to MiChel

Material: Stainless steel

Other Sizes:
011-0916-12 : 12 cm



Suture
Clip applying forceps, acc. to MiChel

Material: Stainless steel

Other Sizes:
011-0928-12 : 12.5 cm



Suture
Clip applying forceps, acc. to MiChel, long

Material: Stainless steel

Other Sizes:
011-0929-12 : 13 cm



Suture
Clip applying forceps, acc. to RiChter

Material: Stainless steel

Other Sizes:
011-0935-14 : 13.5 cm



Suture
Instrument set, wound treatment, small

Material: Stainless steel

Other Sizes:
011-0972-00 : small

DRESSINGS

— RANGE

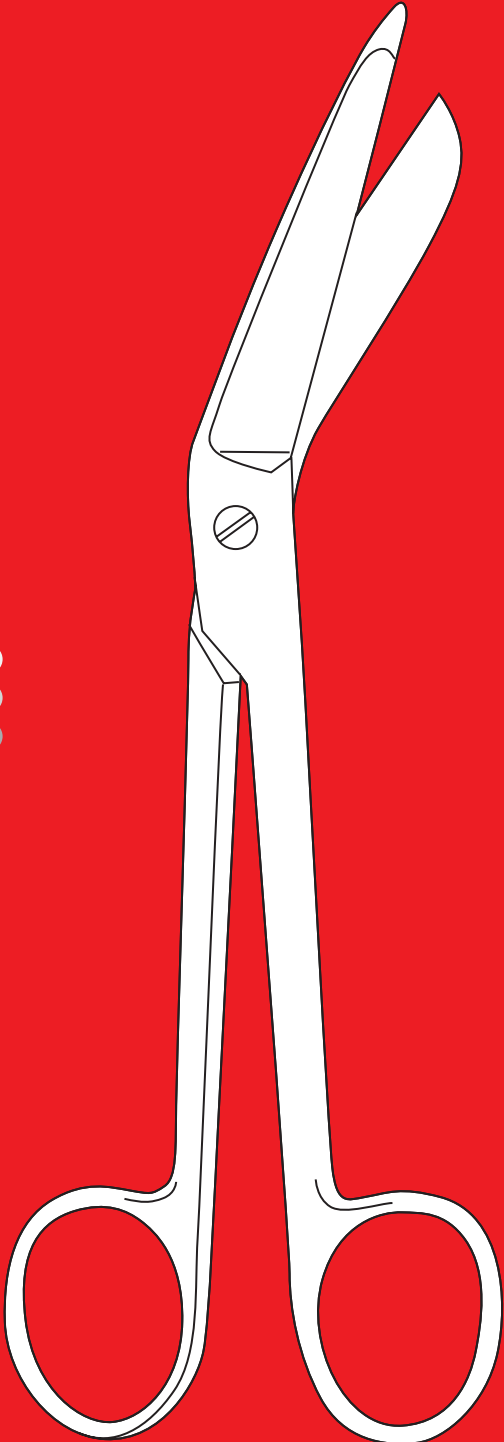

DISCOVER NOW

“Instruments for
surgical procedures”
Since 1970

DRESSINGS



Dressings

Plaster spreader, acc. to Hennig

Material: Stainless steel

Other Sizes:
012-0520-28 : 28 cm

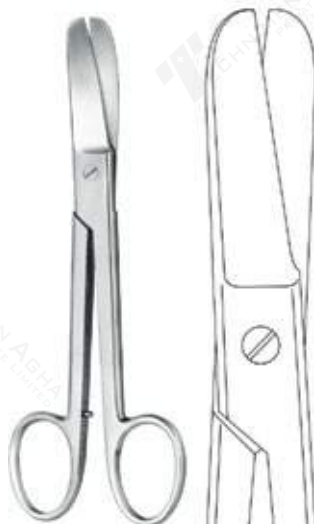

Dressings

Bandage scissors, acc. to Lorenz, curved

Material: Stainless steel

Other Sizes:
012-0155-23 : 23 cm

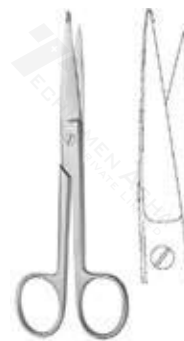

Dressings

Bandage scissors, acc. to Knowles, straight

Material: Stainless steel

Other Sizes:
012-0160-14 : 14 cm



Dressings

Bandage scissors, acc. to Lister

Material: Stainless steel

Other Sizes:
012-0165-14 : 14.5 cm
012-0165-18 : 18.5 cm
012-0165-20 : 20 cm



Dressings

Plaster shears, acc. to Bergmann, angled

Material: Stainless steel

Other Sizes:
012-0195-23 : 23.5 cm



Dressings

Plaster shears, acc. to Esmarch, angled

Material: Stainless steel

Other Sizes:
012-0205-20 : 20 cm

DRESSINGS



Dressings

Bandage scissors, model "Universal"

Material: steel 18/8 martinit, antimagnetic, stainless, acid-resistant

Other Sizes:

012-0209-15	16 cm
012-0209-18	19 cm

Available Color: Red / Blue / Green / Gray / Black



Dressings

Plaster shears, acc. to Bruns, serrated

Material: Stainless steel

Other Sizes:

012-0223-24	24 cm
-------------	-------



Dressings

Plaster shears, acc. to Bruns, smooth

Material: Stainless steel

Other Sizes:

012-0223-26	24 cm
-------------	-------



Dressings

Plaster shears, acc. to Stille, model "Martin"

Material: Stainless steel

Other Sizes:

012-0275-23	23 cm
012-0275-26	27 cm
012-0275-37	38 cm



Dressings

Spare blade, for 012-0275-23

Material: Stainless steel

Other Sizes:

012-0277-23	N/A
-------------	-----



Dressings

Spare blade, for 012-0275-26

Material: Stainless steel

Other Sizes:

012-0277-26	N/A
-------------	-----

DRESSINGS

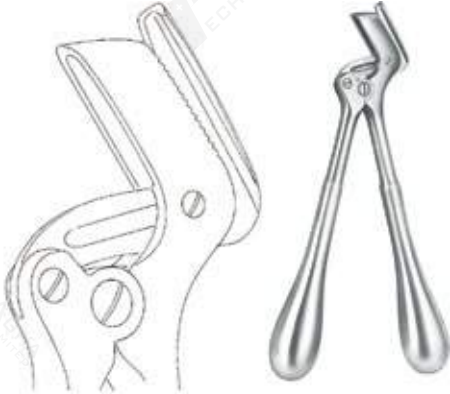

Dressings

Spare blade, for 012-0275-37

Material: Stainless steel

Other Sizes:

012-0277-37 N/A



Dressings

TC bandage scissors, acc. to Lister

Material: Stainless steel

Other Sizes:

012-0291-18 18 cm



Dressings

TC Plaster shears, acc. to Brun

Material: Stainless steel

Other Sizes:

012-0297-24 24 cm



Dressings

Plaster knife, acc. to Hopkins

Material: Stainless steel

Other Sizes:

012-0401-20 20 cm



Dressings

Plaster knife, acc. to EsmarCh

Material: Stainless steel

Other Sizes:

012-0420-18 18 cm



Dressings

Plaster knife, acc. to Reiner, curved

Material: Stainless steel

Other Sizes:

012-0425-18 18 cm

DRESSINGS



Dressings

Plaster knife, acc. to Martin

Material: Stainless steel

Other Sizes:

012-0431-21 21 cm



Dressings

Plaster spreader, acc. to Quattro

Material: Stainless steel

Other Sizes:

012-0522-23 23 cm



Dressings

Plaster breaking forceps, acc. to acc. to Wolff

Material: Stainless steel

Other Sizes:

012-0541-18 18 cm



Dressings

Plaster breaking forceps, acc. to acc. to Wolff

Material: Stainless steel

Other Sizes:

012-0545-24 26.5 cm



Dressings

Plaster saw, electric, oscillating, 230 VOLT

Material: all other, not specially marked material types

Other Sizes:

012-0551-00 230 VOLT
012-0551-01 110 VOLT



Dressings

Saw blade, for hard bandage for 012-0551-00 and 012-0551-01

Material: Stainless steel

Other Sizes:

012-0553-50 Ø 50 mm
012-0553-65 Ø 65 mm

BONE SURGERY

— RANGE

DISCOVER NOW

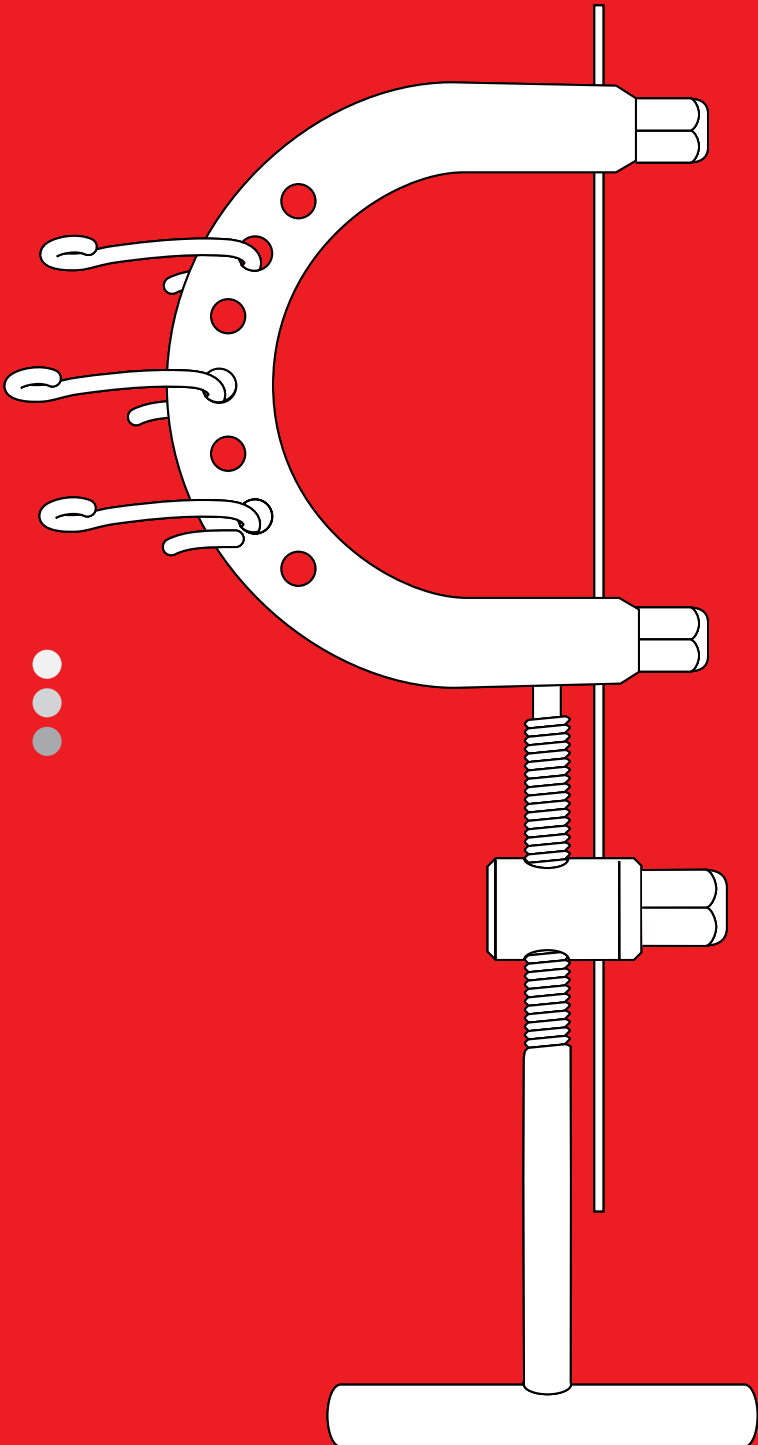

“Instruments for
surgical procedures”
Since 1970

BONE SURGERY



Bone Surgery
N/A

Material: Stainless steel

Other Sizes:
013-0130-14 : 13.5 cm



Bone Surgery
N/A

Material: Stainless steel

Other Sizes:
013-0132-18 : 18 cm



Bone Surgery
N/A

Material: Stainless steel

Other Sizes:
013-0134-21 : 21.5 cm



Bone Surgery
N/A

Material: Stainless steel

Other Sizes:
013-0136-14 : 14 cm



Bone Surgery
N/A

Material: Stainless steel

Other Sizes:
013-0500-01 : 15.5 cm
013-0500-02 : 18 cm



Bone Surgery
N/A

Material: Stainless steel

Other Sizes:
013-0500-11 : 15.5 cm
013-0500-12 : 18 cm

BONE SURGERY



Bone Surgery
N/A

Material: Stainless steel

Other Sizes:
013-0500-15 : 20 cm



Bone Surgery
N/A

Material: Stainless steel

Other Sizes:
013-0500-20 : 20 cm



Bone Surgery
N/A

Material: Stainless steel

Other Sizes:
013-0501-15 : 15.5 cm



Bone Surgery
N/A

Material: Stainless steel

Other Sizes:
013-0502-01 : 16 cm



Bone Surgery
N/A

Material: Stainless steel

Other Sizes:
013-0505-17 : 18.5 cm



Bone Surgery
N/A

Material: Stainless steel

Other Sizes:
013-0506-18 : 19 cm

BONE SURGERY



Bone Surgery
N/A

Material: Stainless steel

Other Sizes:
013-0510-15 : 15 cm



Bone Surgery
N/A

Material: Stainless steel

Other Sizes:
013-0510-18 : 18 cm



Bone Surgery
N/A

Material: Stainless steel

Other Sizes:
013-0511-01 : 18 cm
013-0511-02 : 18 cm
013-0511-03 : 18 cm



Bone Surgery
N/A

Material: Stainless steel

Other Sizes:
013-0512-18 : 18 cm



Bone Surgery
N/A

Material: Stainless steel

Other Sizes:
013-0514-18 : 18 cm



Bone Surgery
N/A

Material: Stainless steel

Other Sizes:
013-0516-14 : 13.5 cm

BONE SURGERY



Bone Surgery
N/A

Material: Stainless steel

Other Sizes:
013-0516-18 : 18 cm



Bone Surgery
N/A

Material: Stainless steel

Other Sizes:
013-0518-16 : 16 cm



Bone Surgery
N/A

Material: Stainless steel

Other Sizes:
013-0519-01 : 17.5 cm



Bone Surgery
N/A

Material: Stainless steel

Other Sizes:
013-0519-02 : 17 cm



Bone Surgery
flat nose plier, pointed

Material: Stainless steel

Other Sizes:
013-0519-03 : 19.5 cm



Bone Surgery
N/A

Material: Stainless steel

Other Sizes:
013-0520-18 : 18.5 cm



Bone Surgery
N/A

Material: Stainless steel

Other Sizes:
013-0522-16 : 16 cm



Bone Surgery
N/A

Material: Stainless steel

Other Sizes:
013-0523-16 : 17 cm



Bone Surgery
N/A

Material: Stainless steel

Other Sizes:
013-0523-22 : 22.5 cm



Bone Surgery
N/A

Material: Stainless steel

Other Sizes:
013-0524-15 : 15 cm



Bone Surgery
N/A

Material: Stainless steel

Other Sizes:
013-0526-18 : 17.5 cm



Bone Surgery
Suction tube, no. 0, for 18-545-00-01

Material: Stainless steel

Other Sizes:
009-0545-10 : 10 cm

BONE SURGERY



Bone Surgery
Scull breaker, acc. to VirChow

Material: Stainless steel

Other Sizes:
014-0036-00 : 7.5 cm



Bone Surgery
N/A

Material: Stainless steel

Other Sizes:
014-0060-02 : 16 cm, 2mm
014-0060-03 : 16 cm, 3mm
014-0060-04 : 16 cm, 4mm



Bone Surgery
N/A

Material: Stainless steel

Other Sizes:
014-0061-02 : 16 cm, 2mm
014-0061-03 : 16 cm, 3mm
014-0061-04 : 16 cm, 4mm



Bone Surgery
N/A

Material: Stainless steel

Other Sizes:
014-0062-03 : 21 cm, 3mm
014-0062-04 : 21 cm, 4mm
014-0062-05 : 21 cm, 5mm



Bone Surgery
flat nose plier, pointed

Material: Stainless steel

Other Sizes:
014-0068-04 : 18 cm, 4mm



Bone Surgery
N/A

Material: octagonal handle

Other Sizes:
014-0070-04 : 18 cm





Bone Surgery
Bone Chisel, 4 mm

Material: Stainless steel

Other Sizes:
014-0072-04 : 17 cm



Bone Surgery
Osteotome, 4 mm

Material: Stainless steel

Other Sizes:
014-0074-04 : 17 cm



Bone Surgery
Chisel, acc. to Gardner, straight, 4 mm

Material: Stainless steel

Other Sizes:
014-0076-01 : 17 cm



Bone Surgery
Chisel, acc. to Gardner, curved upwards, 4 mm

Material: Stainless steel

Other Sizes:
014-0076-02 : 17 cm



Bone Surgery
Chisel, acc. to Gardner, curved downwards, 4 mm

Material: Stainless steel

Other Sizes:
014-0076-03 : 17 cm



Bone Surgery
Gouge, acc. to Snyder-Osu, 3 mm

Material: Stainless steel

Other Sizes:
014-0080-03 : 16.5 cm



Bone Surgery
Gouge, acc. to Snyder-Osu, 5 mm

Material: Stainless steel

Other Sizes:
014-0080-05 : 16.5 cm



Bone Surgery
N/A

Material: Stainless steel

Other Sizes:
014-0082-01 : 17 cm, 7mm



Bone Surgery
N/A

Material: Stainless steel

Other Sizes:
014-0084-01 : 17 cm, 9mm



Bone Surgery
Osteotome

Material: Stainless steel

Other Sizes:
014-0100-08 : 8 mm, 13.5 cm
014-0100-10 : 10 mm, 13.5 cm
014-0100-12 : 12 mm, 13.5 cm
014-0100-14 : 14 mm, 13.5 cm
014-0100-16 : 16 mm, 13.5 cm



Bone Surgery
Chisel

Material: Stainless steel

Other Sizes:
014-0101-08 : 8 mm, 13.5 cm
014-0101-10 : 10 mm, 13.5 cm
014-0101-12 : 12 mm, 13.5 cm
014-0101-14 : 14 mm, 13.5 cm
014-0101-16 : 16 mm, 13.5 cm



Bone Surgery
GOUGE

Material: Stainless steel

Other Sizes:
014-0102-08 : 8 mm, 13.5 cm
014-0102-10 : 10 mm, 13.5 cm
014-0102-12 : 12 mm, 13.5 cm
014-0102-14 : 14 mm, 13.5 cm
014-0102-16 : 16 mm, 13.5 cm



Bone Surgery
Chisels, acc. to PartsCh

Material: Stainless steel

Other Sizes:

014-0105-02	2 mm, 13.5 cm
014-0105-03	3 mm, 13.5 cm
014-0105-04	4 mm, 13.5 cm
014-0105-05	5 mm, 13.5 cm
014-0105-06	6 mm, 13.5 cm



Bone Surgery
Chisels, acc. to PartsCh

Material: Stainless steel

Other Sizes:

014-0106-02	2 mm, 17 cm
014-0106-03	3 mm, 17 cm
014-0106-04	4 mm, 17 cm
014-0106-05	5 mm, 17 cm
014-0106-06	6 mm, 17 cm



Bone Surgery
Gouge, acc. to PartsCh

Material: Stainless steel

Other Sizes:

014-0109-02	2 mm, 13.5 cm
014-0109-03	3 mm, 13.5 cm
014-0109-04	4 mm, 13.5 cm
014-0109-05	5 mm, 13.5 cm
014-0109-06	6 mm, 13.5 cm



Bone Surgery
Gouge, acc. to PartsCh

Material: Stainless steel

Other Sizes:

014-0110-02	2 mm, 17 cm
014-0110-03	3 mm, 17 cm
014-0110-04	4 mm, 17 cm
014-0110-05	5 mm, 17 cm
014-0110-06	6 mm, 17 cm



Bone Surgery
Chisel, acc. to Alexander

Material: Stainless steel

Other Sizes:

014-0118-06	6 mm, 17.5 cm
014-0118-08	8 mm, 17.5 cm
014-0118-10	10 mm, 17.5 cm
014-0118-12	12 mm, 17.5 cm
014-0118-14	14 mm, 17.5 cm



Bone Surgery
Gouge, acc. to Alexander

Material: Stainless steel

Other Sizes:

014-0119-06	6 mm, 17.5 cm
014-0119-08	8 mm, 17.5 cm
014-0119-10	10 mm, 17.5 cm
014-0119-12	12 mm, 17.5 cm
014-0119-14	14 mm, 17.5 cm



Bone Surgery
Chisel, acc. to Stille

Material: Stainless steel

Other Sizes:

014-0123-10	10 mm, 20 cm
014-0123-12	12 mm, 20 cm
014-0123-15	15 mm, 20 cm
014-0123-20	20 mm, 20 cm
014-0123-25	25 mm, 20 cm



Bone Surgery
Osteotome, acc. to Stille

Material: Stainless steel

Other Sizes:

014-0124-10	10 mm, 20 cm
014-0124-15	15 mm, 20 cm
014-0124-20	20 mm, 20 cm
014-0124-25	25 mm, 20 cm
014-0124-08	8 mm, 20 cm
014-0124-12	12 mm, 20 cm



Bone Surgery
Osteotome, acc. to Stille, fine

Material: Stainless steel

Other Sizes:

014-0125-10	10 mm, 20.5 cm
014-0125-12	12 mm, 20.5 cm
014-0125-15	15 mm, 20.5 cm
014-0125-20	20 mm, 20.5 cm
014-0125-25	25 mm, 20.5 cm



Bone Surgery
Gouge, acc. to Stille

Material: Stainless steel

Other Sizes:

014-0127-10	10 mm, 20 cm
014-0127-15	15 mm, 20 cm
014-0127-20	20 mm, 20 cm
014-0127-25	25 mm, 20 cm
014-0127-12	12 mm, 20 cm



Bone Surgery
Gouge blade

Material: Stainless steel

Other Sizes:

014-0128-50	50 mm, 13.5 cm
014-0128-60	60 mm, 13.5 cm
014-0128-70	70 mm, 13.5 cm



Bone Surgery
Chisel blade, straight, for 014-0130-00

Material: Stainless steel

Other Sizes:

014-0130-05	5 mm, 8 cm
-------------	------------



Bone Surgery
Chisel blade, straight, for 014-0130-00

Material: Stainless steel

Other Sizes:
014-0130-10 : 10 mm, 8 cm



Bone Surgery
Chisel blade, straight, for 014-0130-00

Material: Stainless steel

Other Sizes:
014-0130-16 : 16 mm, 8 cm



Bone Surgery
Chisel blade, straight, for 014-0130-00

Material: Stainless steel

Other Sizes:
014-0130-25 : 25 mm, 8 cm



Bone Surgery
Osteotome blade, for 014-0130-00

Material: Stainless steel

Other Sizes:
014-0130-55 : 5 mm, 8 cm



Bone Surgery
Osteotome blade, for 014-0130-00

Material: Stainless steel

Other Sizes:
014-0130-60 : 10 mm, 8 cm



Bone Surgery
Osteotome blade, for 014-0130-00

Material: Stainless steel

Other Sizes:
014-0130-66 : 16 mm, 8 cm

BONE SURGERY



Bone Surgery
Fixation screw, for 014-0130-00

Material: Stainless steel

Other Sizes:
014-0130-90 : N/A



Bone Surgery
Key, for 014-0130-00

Material: Stainless steel

Other Sizes:
014-0130-99 : N/A



Bone Surgery
Osteotome blade, for 014-0130-00

Material: Stainless steel

Other Sizes:
014-0130-85 : 25 mm, 8 cm



Bone Surgery
Spongiosa gouge, straight,
silicone coated Handle

Material: all other, not specially
marked material types

Other Sizes:
014-0131-05 : 5 mm, 24.5 cm
014-0131-10 : 10 mm, 24.5 cm
014-0131-15 : 15 mm, 24.5 cm



Bone Surgery
Spongiosa gouge, curved,
silicone coated Handle

Material: all other, not specially
marked material types

Other Sizes:
014-0131-55 : 5 mm, 24.5cm
014-0131-60 : 10 mm, 24.5cm
014-0131-65 : 15 mm, 24.5cm



Bone Surgery
Osteotome, acc. to Mini-Lexer,
silicone coated Handle, 4 mm, 18 cm

Material: all other, not specially
marked material types

Other Sizes:
014-0132-04 : 4 mm, 18 cm
014-0132-06 : 6 mm, 18 cm
014-0132-08 : 8 mm, 18 cm
014-0132-10 : 10 mm, 18 cm
014-0132-12 : 12 mm, 18 cm



Bone Surgery

Gouge, acc. to Mini-Lexer, silicone coated Handle

Material: all other, not specially marked material types

Other Sizes:

014-0133-04	4 mm, 18 cm
014-0133-06	6 mm, 18 cm
014-0133-08	8 mm, 18 cm
014-0133-10	10 mm, 18 cm
014-0133-12	12 mm, 18 cm



Bone Surgery

Osteotome, acc. to Lexer, silicone coated Handle

Material: all other, not specially marked material types

Other Sizes:

014-0134-05	5 mm, 22 cm
014-0134-07	7 mm, 22 cm
014-0134-10	10 mm, 22 cm
014-0134-15	15 mm, 22 cm
014-0134-20	20 mm, 22 cm
014-0134-25	25 mm, 22 cm
014-0134-30	30 mm, 22 cm



Bone Surgery

Gouge, acc. to Lexer, silicone coated Handle

Material: all other, not specially marked material types

Other Sizes:

014-0135-05	5 mm, 22 cm
014-0135-07	7 mm, 22 cm
014-0135-10	10 mm, 22 cm
014-0135-15	15 mm, 22 cm
014-0135-20	20 mm, 22 cm
014-0135-25	25 mm, 22 cm
014-0135-30	30 mm, 22 cm



Bone Surgery

Osteotome, acc. to Mini-Lambotte

Material: Stainless steel

Other Sizes:

014-0136-02	2 mm, 12.5 cm
014-0136-03	3 mm, 12.5 cm
014-0136-04	4 mm, 12.5 cm
014-0136-06	6 mm, 12.5 cm
014-0136-08	8 mm, 12.5 cm
014-0136-10	10 mm, 12.5 cm
014-0136-12	12 mm, 12.5 cm
014-0136-15	15 mm, 17 cm



Bone Surgery

Osteotome, acc. to Mini-Lambotte

Material: Stainless steel

Other Sizes:

014-0136-53	3 mm, 17 cm
014-0136-54	4 mm, 17 cm
014-0136-56	6 mm, 17 cm
014-0136-58	8 mm, 17 cm
014-0136-60	10 mm, 17 cm
014-0136-62	12 mm, 17 cm
014-0136-65	16 mm, 17 cm



Bone Surgery

Osteotome, acc. to Lambotte

Material: Stainless steel

Other Sizes:

014-0138-04	04 mm, 24 cm
014-0138-06	06 mm, 24 cm
014-0138-08	08 mm, 24 cm
014-0138-10	10 mm, 24 cm
014-0138-13	13 mm, 24 cm
014-0138-15	15 mm, 24 cm
014-0138-18	18 mm, 24 cm
014-0138-20	20 mm, 24 cm
014-0138-25	25 mm, 24 cm
014-0138-30	30 mm, 24 cm
014-0138-38	38 mm, 24 cm
014-0138-44	44 mm, 24 cm



Bone Surgery

Osteotome, acc. to Lambotte, curved

Material: Stainless steel

Other Sizes:

014-0139-04	4 mm, 24 cm
014-0139-06	6 mm, 24 cm
014-0139-08	8 mm, 24 cm
014-0139-10	10 mm, 24 cm
014-0139-13	13 mm, 24 cm
014-0139-15	15 mm, 24 cm
014-0139-18	18 mm, 24 cm
014-0139-20	20 mm, 24 cm
014-0139-25	25 mm, 24 cm
014-0139-30	30 mm, 24 cm
014-0139-38	38 mm, 24 cm
014-0139-44	44 mm, 24 cm
014-0139-50	50 mm, 24 cm



Bone Surgery

Osteotome, acc. to Smith-Petersen

Material: Stainless steel

Other Sizes:

014-0154-06	6 mm, 20.5 cm
014-0154-09	9 mm, 20.5 cm
014-0154-13	13 mm, 20.5 cm
014-0154-16	16 mm, 20.5 cm
014-0154-19	19 mm, 20.5 cm
014-0154-25	25 mm, 20.5 cm
014-0154-32	32 mm, 20.5 cm



Bone Surgery

Osteotome, acc. to Smith-Petersen, curved

Material: Stainless steel

Other Sizes:

014-0155-06	6 mm, 20.5 cm
014-0155-09	9 mm, 20.5 cm
014-0155-13	13 mm, 20.5 cm
014-0155-16	16 mm, 20.5 cm
014-0155-19	19 mm, 20.5 cm
014-0155-25	25 mm, 20.5 cm
014-0155-32	32 mm, 20.5 cm



Bone Surgery

Gouge, acc. to Smith-Petersen

Material: Stainless steel

Other Sizes:

014-0156-09	9 mm, 20.5 cm
014-0156-14	14 mm, 20.5 cm
014-0156-19	19 mm, 20.5 cm
014-0156-25	25 mm, 20.5 cm



Bone Surgery

Osteotome, acc. to Smith-Petersen, curved

Material: Stainless steel

Other Sizes:

014-0157-09	9 mm, 20.5 cm
014-0157-14	14 mm, 20.5 cm
014-0157-19	19 mm, 20.5 cm
014-0157-25	25 mm, 20.5 cm



Bone Surgery

Gouge, acc. to Cobb, straight,
silicone coated Handle

Material: all other, not specially
marked material types

Other Sizes:

014-0160-01	6 mm, 28 cm
-------------	-------------



Bone Surgery

Gouge, acc. to Cobb, slightly curved, silicone coated Handle

Material: all other, not specially marked material types

Other Sizes:

014-0160-02 6 mm, 28 cm



Bone Surgery

Gouge, acc. to Cobb, strongly curved, silicone coated Handle

Material: all other, not specially marked material types

Other Sizes:

014-0160-03 6 mm, 28 cm



Bone Surgery

Gouge, acc. to Cobb, backwards curved, silicone coated Handle

Material: all other, not specially marked material types

Other Sizes:

014-0160-0 6 mm, 28 cm



Bone Surgery

Osteotome, acc. to Hoke

Material: Stainless steel

Other Sizes:

014-0162-03 35 mm, 17 cm
 014-0162-05 5 mm, 17 cm
 014-0162-06 6 mm, 17 cm
 014-0162-08 8 mm, 17 cm
 014-0162-09 9 mm, 17 cm



Bone Surgery

Osteotome, acc. to Hibbs

Material: Stainless steel

Other Sizes:

014-0170-06 6 mm, 24.5 cm
 014-0170-13 13 mm, 24.5 cm
 014-0170-19 19 mm, 24.5 cm
 014-0170-25 25 mm, 24.5 cm
 014-0170-32 32 mm, 24.5 cm



Bone Surgery

Chisel, acc. to Hibbs, straight

Material: Stainless steel

Other Sizes:

014-0172-06 6 mm, 24.5 cm
 014-0172-13 13 mm, 24.5 cm
 014-0172-19 19 mm, 24.5 cm
 014-0172-25 25 mm, 24.5 cm
 014-0172-32 32 mm, 24.5 cm



Bone Surgery
Osteotome, acc. to Hibbs, curved

Material: Stainless steel

Other Sizes:

014-0173-06	6 mm, 24.5 cm
014-0173-13	13 mm, 24.5 cm
014-0173-19	19 mm, 24.5 cm
014-0173-25	25 mm, 24.5 cm
014-0173-32	32 mm, 24.5 cm



Bone Surgery
Gouge, acc. to Hibbs, straight

Material: Stainless steel

Other Sizes:

014-0176-06	6 mm, 24.5 cm
014-0176-13	13 mm, 24.5 cm
014-0176-19	19 mm, 24.5 cm
014-0176-25	25 mm, 24.5 cm
014-0176-32	32 mm, 24.5 cm



Bone Surgery
Gouge, acc. to Hibbs, curved

Material: Stainless steel

Other Sizes:

014-0177-06	6 mm, 24.5 cm
014-0177-13	13 mm, 24.5 cm
014-0177-19	19 mm, 24.5 cm
014-0177-25	25 mm, 24.5 cm
014-0177-32	32 mm, 24.5 cm



Bone Surgery
Bone rasp, acc. to Putti, round

Material: Stainless steel

Other Sizes:

014-0181-30	30 cm
-------------	-------



Bone Surgery
Bone rasp, acc. to Putti, flat

Material: Stainless steel

Other Sizes:

014-0183-27	27 cm
-------------	-------



Bone Surgery
Tamper, acc. to Caspar, silicone coated Handle

Material: all other, not specially marked material types

Other Sizes:

014-0197-03	Ø 3 mm, 22 cm
014-0197-05	Ø 5 mm, 22 cm
014-0197-08	Ø 8 mm, 22 cm

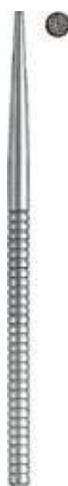

Bone Surgery
Tamper, metal

Material: Stainless steel

Other Sizes:

014-0198-02	∅ 2 mm, 15.5 cm
014-0198-03	∅ 3 mm, 15.5 cm
014-0198-04	∅ 4 mm, 15.5 cm
014-0198-05	∅ 5 mm, 15.5 cm
014-0198-06	∅ 6 mm, 15.5 cm
014-0198-08	∅ 8 mm, 15.5 cm



Bone Surgery
Tamper, Caspar, silicone coated Handle

Material: all other, not specially marked material types

Other Sizes:

014-0199-12	∅ 12 mm, 20 cm
014-0199-140	∅ 14 mm, 20 cm
014-0199-16	∅ 16 mm, 20 cm



Bone Surgery
Mallet, acc. to Williger, 300 g

Material: Stainless steel

Other Sizes:

014-0200-01	24 cm
-------------	-------



Bone Surgery
Mallet, acc. to Williger, 340 g

Material: Stainless steel

Other Sizes:

014-0200-02	24 cm
-------------	-------



Bone Surgery
Mallet, acc. to Williger, 400 g

Material: Stainless steel

Other Sizes:

014-0200-03	24 cm
-------------	-------



Bone Surgery
Mallet, acc. to acc. to Doyen, 120 g

Material: Stainless steel

Other Sizes:

014-0204-01	20.5 cm
-------------	---------



Bone Surgery
Mallet, acc. to acc. to Doyen, 180 g

Material: Stainless steel

Other Sizes:
014-0204-02 : 21 cm

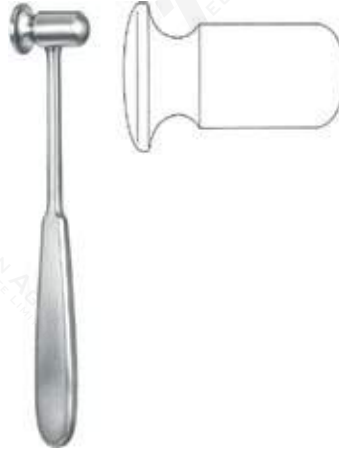

Bone Surgery
Mallet, acc. to acc. to Doyen, 260 g

Material: Stainless steel

Other Sizes:
014-0204-03 : 21.5 cm



Bone Surgery
Mallet, acc. to acc. to Collin, 220 g

Material: Stainless steel

Other Sizes:
014-0208-20 : Ø 30 mm, 20 cm



Bone Surgery
Mallet, acc. to Lucae, 230 g

Material: Stainless steel

Other Sizes:
014-0214-01 : Ø 19 mm, 19.5 cm



Bone Surgery
Mallet, acc. to Lucae, 260 g

Material: Stainless steel

Other Sizes:
014-0214-02 : Ø 25 mm, 19.5 cm



Bone Surgery
Mallet, acc. to Cottle, 300 g

Material: Stainless steel

Other Sizes:
014-0215-19 : 19 cm

BONE SURGERY



Bone Surgery
Mallet, acc. to Williger, 140 g

Material: Stainless steel

Other Sizes:
014-0216-01 : 16.5 cm



Bone Surgery
Mallet, plastic Handle "Ferozell", 510 g

Material: Stainless steel

Other Sizes:
014-0218-22 : 26 cm



Bone Surgery
Mallet, acc. to Mead, plastic inserts
"Ferozell" 320 g

Material: Stainless steel

Other Sizes:
014-0220-17 : 19 cm



Bone Surgery
Mallet, acc. to PartsCh, 200 g

Material: Stainless steel

Other Sizes:
014-0224-18 : 19 cm



Bone Surgery
Bone curette, acc. to Volkmann,
silicone coated Handle

Material: all other, not specially
marked material types

Other Sizes:
014-0282-10 : 27 cm
014-0282-01 : 27 cm
014-0282-02 : 27 cm
014-0282-03 : 27 cm
014-0282-04 : 27 cm



Bone Surgery
Bone curette, acc. to Volkmann,
silicone coated Handle

Material: all other, not specially
marked material types

Other Sizes:
014-0280-40 : 17 cm
014-0280-30 : 17 cm
014-0280-20 : 17 cm
014-0280-10 : 17 cm
014-0280-01 : 17 cm
014-0280-02 : 17 cm
014-0280-03 : 17 cm
014-0280-04 : 17 cm
014-0280-05 : 17 cm
014-0280-06 : 17 cm

BONE SURGERY



Bone Surgery

Bone curette, acc. to SChede, with hollow Handle, oval

Material: Stainless steel

Other Sizes:

014-0300-10	17 cm
014-0300-20	17 cm
014-0300-30	17 cm



Bone Surgery

Bone curette, acc. to SChede, with hollow Handle, oval

Material: Stainless steel

Other Sizes:

014-0301-01	17 cm
014-0301-02	17 cm
014-0301-03	17 cm
014-0301-04	17 cm



Bone Surgery

Bone curette, acc. to Volkmann, with hollow Handle, oval

Material: Stainless steel

Other Sizes:

014-0304-40	17 cm
014-0304-30	17 cm
014-0304-20	17 cm
014-0304-10	17 cm



Bone Surgery

Bone curette, acc. to Volkmann, with hollow Handle, oval

Material: Stainless steel

Other Sizes:

014-0305-01	17 cm
014-0305-02	17 cm
014-0305-03	17 cm
014-0305-04	17 cm
014-0305-05	17 cm
014-0305-06	17 cm



Bone Surgery

Bone curette, acc. to Daubenspeck, with hollow Handle, oval

Material: Stainless steel

Other Sizes:

014-0306-40	17 cm
014-0306-30	17 cm
014-0306-20	17 cm
014-0306-10	17 cm



Bone Surgery

Bone curette, acc. to Bruns, with hollow Handle, round

Material: Stainless steel

Other Sizes:

014-0308-40	17 cm
014-0308-30	17 cm
014-0308-20	17 cm
014-0308-10	17 cm

BONE SURGERY



Bone Surgery

Bone curette, acc. to Brunns, with hollow Handle, round

Material: Stainless steel

Other Sizes:

014-0309-01	17 cm
014-0309-02	17 cm
014-0309-03	17 cm
014-0309-04	17 cm
014-0309-05	17 cm
014-0309-06	17 cm



Bone Surgery

Bone curette, acc. to Spratt, with hollow Handle, oval

Material: Stainless steel

Other Sizes:

014-0312-40	17 cm
014-0312-30	17 cm
014-0312-20	17 cm
014-0312-10	17 cm



Bone Surgery

Bone curette, acc. to Spratt, with hollow Handle, oval

Material: Stainless steel

Other Sizes:

014-0313-01	17 cm
014-0313-02	17 cm
014-0313-03	17 cm
014-0313-04	17 cm
014-0313-05	17 cm



Bone Surgery

Bone curette, acc. to Brunns, solid, oval

Material: Stainless steel

Other Sizes:

014-0334-30	23 cm
014-0334-20	23 cm
014-0334-10	23 cm



Bone Surgery

Bone curette, acc. to Brunns, solid, oval

Material: Stainless steel

Other Sizes:

014-0335-01	23 cm
014-0335-02	23 cm
014-0335-03	23 cm
014-0335-04	23 cm
014-0335-05	23 cm
014-0335-06	23 cm



Bone Surgery

Bone curette, acc. to Scoville, with hollow Handle, straight

Material: Stainless steel

Other Sizes:

014-0336-25	25 cm
-------------	-------



Bone Surgery

Bone curette, acc. to Scoville, with hollow Handle, angled downwards

Material: Stainless steel

Other Sizes:

014-0337-25 25 cm



Bone Surgery

Bone curette, acc. to Scoville, with hollow Handle, angled upwards

Material: Stainless steel

Other Sizes:

014-0339-25 25 cm



Bone Surgery

Bone curette, acc. to acc. to Simon, with hollow Handle, oval

Material: Stainless steel

Other Sizes:

014-0340-01 25 cm
 014-0340-02 25 cm
 014-0340-03 25 cm
 014-0340-04 25 cm
 014-0340-05 25 cm
 014-0340-06 25 cm



Bone Surgery

Bone curette, angled down

Material: Stainless steel

Other Sizes:

14-0342-30 25 cm
 014-0342-20 25 cm
 014-0342-10 25 cm
 014-0342-01 25 cm



Bone Surgery

Bone curette, model "USA", with hollow Handle, oval

Material: Stainless steel

Other Sizes:

014-0344-01 25 cm
 014-0344-02 25 cm
 014-0344-03 25 cm
 014-0344-04 25 cm
 014-0344-05 25 cm
 014-0344-06 25 cm



Bone Surgery

Bone curette, model "USA", with hollow Handle, oval, right angled

Material: Stainless steel

Other Sizes:

014-0345-01 15.5 cm
 014-0345-02 15.5 cm
 014-0345-03 15.5 cm
 014-0345-04 15.5 cm
 014-0345-05 15.5 cm
 014-0345-06 15.5 cm



Bone Surgery

Bone curette, model "USA", with hollow Handle, oval, left angled

Material: Stainless steel

Other Sizes:

014-0347-01	15.5 cm
014-0347-02	15.5 cm
014-0347-03	15.5 cm
014-0347-04	15.5 cm
014-0347-05	15.5 cm
014-0347-06	15.5 cm



Bone Surgery

Bone curette, acc. to Bushe, with hollow Handle, oval

Material: Stainless steel

Other Sizes:

014-0348-03	3 mm, 25 cm
014-0348-04	4 mm, 25 cm
014-0348-05	5 mm, 25 cm



Bone Surgery

Bone curette, acc. to Halle, with hollow Handle, malleable shaft, oval

Material: Stainless steel

Other Sizes:

014-0350-01	21 cm
014-0350-02	21 cm
014-0350-03	21 cm



Bone Surgery

Bone curette, acc. to acc. to Jacobson, double-ended, oval/oval

Material: Stainless steel

Other Sizes:

014-0351-14	14 cm
-------------	-------



Bone Surgery

Bone curette, acc. to Volkmann, double-ended, oval/oval

Material: Stainless steel

Other Sizes:

014-0352-13	12.5 cm
014-0352-14	14.5 cm
014-0352-17	17 cm



Bone Surgery

Bone curette, acc. to Volkmann, double-ended, oval/round

Material: Stainless steel

Other Sizes:

014-0354-13	13 cm
014-0354-16	16 cm
014-0354-20	20 cm

BONE SURGERY



Bone Surgery

Bone curette, double-ended, oval/round

Material: Stainless steel

Other Sizes:

014-0356-21 : 21 cm



Bone Surgery

Bone curette, acc. to Williger

Material: Stainless steel

Other Sizes:

014-0358-00 : 13.5 cm
014-0358-01 : 13.5 cm
014-0358-02 : 13.5 cm



Bone Surgery

Bone curette, acc. to Williger, oval

Material: Stainless steel

Other Sizes:

014-0359-00 : 17 cm
014-0359-10 : 17 cm
014-0359-11 : 17 cm



Bone Surgery

N/A

Material: Stainless steel

Other Sizes:

014-0371-11 : 18.5 cm
014-0371-22 : 18.5 cm
014-0371-33 : 18.5 cm



Bone Surgery

N/A

Material: Stainless steel

Other Sizes:

014-0373-11 : 18 cm
014-0373-22 : 18 cm
014-0373-33 : 18 cm



Bone Surgery

Hemingway, octagonal handle

Material: Stainless steel

Other Sizes:

014-0375-00 : 18.5 cm
014-0375-10 : 18.5 cm
014-0375-11 : 18.5 cm

BONE SURGERY



Bone Surgery
N/A

Material: Stainless steel

Other Sizes:

014-0384-01 : 17.5 cm



Bone Surgery
N/A

Material: Stainless steel

Other Sizes:

014-0389-11 : 18 cm
014-0389-22 : 18 cm
014-0389-33 : 18 cm
014-0389-44 : 18 cm



Bone Surgery
N/A

Material: Stainless steel

Other Sizes:

014-0393-00 : 17 cm
014-0393-02 : 17 cm
014-0393-03 : 17 cm
014-0393-04 : 17 cm



Bone Surgery
N/A

Material: Stainless steel

Other Sizes:

014-0393-01 : 17 cm

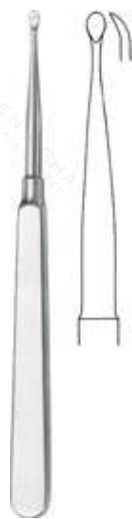

Bone Surgery

Bone curette, acc. to Molt, no. 1

Material: Stainless steel

Other Sizes:

014-0395-01 : 17 cm



Bone Surgery

Bone curette, acc. to Molt, no. 2

Material: Stainless steel

Other Sizes:

014-0395-02 : 17 cm



Bone Surgery

Bone curette, acc. to Molt, no. 4

Material: Stainless steel

Other Sizes:

014-0395-04 : 17 cm



Bone Surgery

Bone curette, acc. to Molt, right angled, no. 5

Material: Stainless steel

Other Sizes:

014-0395-05 : 17.5 cm



Bone Surgery

Bone curette, acc. to Molt, left angled, no. 6

Material: Stainless steel

Other Sizes:

014-0395-06 : 17.5 cm

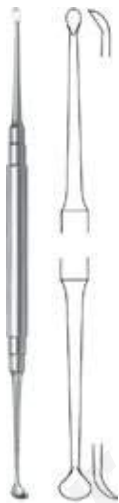

Bone Surgery

Bone curette, acc. to Molt, double-ended

Material: Stainless steel

Other Sizes:

014-0395-24 : 19 cm



Bone Surgery

Raspatory, acc. to Martin-Langenbeck

Material: Stainless steel

Other Sizes:

014-0400-01 : 16 mm, 19 cm



Bone Surgery

Raspatory, acc. to Martin-Langenbeck, round figure

Material: Stainless steel

Other Sizes:

014-0400-02 : 16 mm, 19 cm



Bone Surgery
Raspatorium, acc. to Martin-Langenbeck,
angled

Material: Stainless steel

Other Sizes:
014-0400-03 : 12 mm, 18.5 cm



Bone Surgery
Raspatorium, acc. to Martin-Langenbeck,
strongly angled

Material: Stainless steel

Other Sizes:
014-0400-04 : 12 mm, 18 cm



Bone Surgery
Raspatorium, acc. to Martin-Hoen

Material: Stainless steel

Other Sizes:
014-0400-10 : 7 mm, 16 cm



Bone Surgery
Raspatorium, acc. to Martin-Hoen

Material: Stainless steel

Other Sizes:
014-0400-11 : 15mm, 18.5 cm



Bone Surgery
Raspatorium, acc. to Martin-Hoen

Material: Stainless steel

Other Sizes:
014-0400-12 : 20 mm, 19 cm



Bone Surgery
Raspatorium, acc. to Martin-Cushing

Material: Stainless steel

Other Sizes:
014-0400-20 : 4 mm, 17.5 cm
014-0400-21 : 5 mm, 17.5 cm
014-0400-25 : 6 mm, 17.5 cm
014-0400-26 : 7 mm, 17.5 cm



Bone Surgery
Raspatory, acc. to Martin-Cushing

Material: Stainless steel

Other Sizes:
014-0400-30 : 8 mm, 17 cm



Bone Surgery
Raspatory, acc. to Langenbeck, with hollow Handle, angled

Material: Stainless steel

Other Sizes:
014-0401-18 : 18.5 cm



Bone Surgery
Raspatory, acc. to Langenbeck, with hollow Handle, curved

Material: Stainless steel

Other Sizes:
014-0402-19 : 19.5 cm



Bone Surgery
Raspatory, acc. to Landolt

Material: Stainless steel

Other Sizes:
014-0404-18 : 4.7 mm, 17.5 cm



Bone Surgery
Raspatory, acc. to Jansen

Material: Stainless steel

Other Sizes:
014-0405-17 : 15 mm, 16.5 cm



Bone Surgery
Raspatory, acc. to König

Material: Stainless steel

Other Sizes:
014-0406-16 : 15.5 cm



Bone Surgery

Raspatory, acc. to acc. to Trelat

Material: Stainless steel

Other Sizes:

014-0407-15 : 8 mm, 15 cm



Bone Surgery

Raspatory, acc. to SChneider

Material: Stainless steel

Other Sizes:

014-0408-18 : 13 mm, 17.5 cm



Bone Surgery

Raspatory, acc. to SChneider-SauerbruCh

Material: Stainless steel

Other Sizes:

014-0409-14 : 14 mm



Bone Surgery

Raspatory, fine, angled

Material: Stainless steel

Other Sizes:

014-0411-05 : 5 mm, 16 cm
014-0411-06 : 6 mm, 16 cm
014-0411-07 : 7 mm, 16 cm



Bone Surgery

Raspatory, acc. to Cottle, curved

Material: Stainless steel

Other Sizes:

014-0412-20 : 19.5 cm



Bone Surgery

Raspatory, acc. to Sewall

Material: Stainless steel

Other Sizes:

014-0413-20 : 20 cm



Bone Surgery
Raspatory, acc. to Sedillot

Material: Stainless steel

Other Sizes:
014-0414-19 : 18 mm, 18.5 cm



Bone Surgery
Raspatory, acc. to Farabeuf-Collin, straight

Material: Stainless steel

Other Sizes:
014-0416-11 : 11 mm



Bone Surgery
Raspatory, acc. to Farabeuf-Collin, curved

Material: Stainless steel

Other Sizes:
014-0417-11 : 11 cm



Bone Surgery
Raspatory, acc. to Farabeuf, with hollow Handle, straight

Material: Stainless steel

Other Sizes:
014-0418-15 : 15 cm



Bone Surgery
Raspatory, acc. to Farabeuf, with hollow Handle, curved

Material: Stainless steel

Other Sizes:
014-0419-15 : 15 cm



Bone Surgery
Raspatory, acc. to Farabeuf, with hollow Handle, curved

Material: Stainless steel

Other Sizes:
014-0421-01 : 4 mm



Bone Surgery
Raspatory, acc. to Muehling, slightly curved

Material: Stainless steel

Other Sizes:
014-0421-02 4 mm



Bone Surgery
Raspatory, acc. to Muehling, strongly curved

Material: Stainless steel

Other Sizes:
014-0421-03 4 mm



Bone Surgery
Raspatory, acc. to Muehling, spoon-shape

Material: Stainless steel

Other Sizes:
014-0421-04 4 mm



Bone Surgery
Raspatory, acc. to Key

Material: Stainless steel

Other Sizes:
014-0423-06 3 mm, 19 cm
014-0423-01 6.5 mm, 19 cm
014-0423-02 9.5 mm, 19 cm
014-0423-03 12.5 mm, 19 cm
014-0423-07 16 mm, 19 cm
014-0423-04 10 mm, 19 cm
014-0423-05 24.5 mm, 19 cm



Bone Surgery
Raspatory, acc. to Cobbs

Material: Stainless steel

Other Sizes:
014-0426-06 6 mm, 23 cm
014-0425-06 6 mm, 28 cm



Bone Surgery
Raspatory, acc. to Cobbs

Material: Stainless steel

Other Sizes:
014-0426-10 10 mm, 23 cm
014-0425-10 10 mm, 28 cm

BONE SURGERY



Bone Surgery
Raspatory, acc. to Cobbs

Material: Stainless steel

Other Sizes:

014-0426-13	13 mm, 23 cm
014-0425-13	13 mm, 28 cm



Bone Surgery
Raspatory, acc. to Cobbs

Material: Stainless steel

Other Sizes:

014-0426-19	19 mm, 23 cm
014-0425-19	19 mm, 28 cm



Bone Surgery
Raspatory, acc. to Cobbs

Material: Stainless steel

Other Sizes:

014-0426-25	25 mm, 23 cm
014-0425-25	25 mm, 28 cm



Bone Surgery
Raspatory, acc. to Sedillot, curved

Material: Stainless steel

Other Sizes:

014-0427-21	22 cm
-------------	-------



Bone Surgery
Raspatory, straight, silicone coated Handle

Material: all other, not specially marked material types

Other Sizes:

014-0428-06	6 mm, 20 cm
-------------	-------------



Bone Surgery
Raspatory, straight, round, silicone coated Handle

Material: all other, not specially marked material types

Other Sizes:

014-0429-14	14 mm, 20 cm
-------------	--------------



Bone Surgery

Raspatory, curved, round, silicone coated Handle

Material: all other, not specially marked arial types

Other Sizes:

014-0432-14 : 14 mm, 20 cm



Bone Surgery

Raspatory, curved, round, silicone coated Handle

Material: all other, not specially marked arial types

Other Sizes:

014-0432-18 : 6 mm, 20 cm



Bone Surgery

Raspatory, curved, straight, silicone coated Handle

Material: all other, not specially marked arial types

Other Sizes:

014-0433-03 : 3 mm, 20 cm



Bone Surgery

Raspatory, curved, straight, silicone coated Handle

Material: all other, not specially marked arial types

Other Sizes:

014-0433-13 : 13 mm, 20 cm



Bone Surgery

Raspatory, curved, straight, silicone coated Handle

Material: all other, not specially marked arial types

Other Sizes:

014-0433-18 : 6 mm, 20 cm



Bone Surgery

Raspatory, straight, round

Material: Stainless steel

Other Sizes:

014-0434-13 : 12.5 cm



Bone Surgery
Raspatory, acc. to Kahre-Williger, curved

Material: Stainless steel

Other Sizes:
014-0436-04 : 4 mm



Bone Surgery
Raspatory, acc. to Kahre-Williger, curved

Material: Stainless steel

Other Sizes:
014-0436-05 : 5 mm



Bone Surgery
Raspatory, acc. to Williger, curved

Material: Stainless steel

Other Sizes:
014-0436-07 : 7 mm



Bone Surgery
Raspatory, acc. to Williger, curved

Material: Stainless steel

Other Sizes:
014-0436-16 : 5 mm



Bone Surgery
Raspatory, straight, silicone coated Handle

Material: all other, not specially marked
aterial types

Other Sizes:
014-0437-20 : 19 mm, 20 cm



Bone Surgery
Raspatory, strong curved

Material: Stainless steel

Other Sizes:
014-0438-03 : 3 mm
014-0438-06 : 6 mm



Bone Surgery
Raspatory, curved

Material: Stainless steel

Other Sizes:
014-0439-06 : 17 cm



Bone Surgery
Raspatory, curved

Material: Stainless steel

Other Sizes:
014-0439-08 : 17 cm



Bone Surgery
Rib raspatory, acc. to acc. to Doyen,
left curved, for adults

Material: Stainless steel

Other Sizes:
014-0441-17 : 17.5 cm



Bone Surgery
Rib raspatory, acc. to acc. to Doyen,
right curved, for adults

Material: Stainless steel

Other Sizes:
014-0443-17 : 17.5 cm



Bone Surgery
Rib raspatory, acc. to acc. to Doyen,
left curved, for Children

Material: Stainless steel

Other Sizes:
014-0445-17 : 17.5 cm



Bone Surgery
octagonal handle

Material: Stainless steel

Other Sizes:
014-0446-19 : 18.5 cm

BONE SURGERY



Bone Surgery

Rib raspatory, acc. to acc. to Doyen, left curved, for Children

Material: Stainless steel

Other Sizes:
014-0447-17 : 17.5 cm



Bone Surgery

Ohl

Material: Stainless steel

Other Sizes:
014-0449-17 : 17.5 cm



Bone Surgery

Raspatory, acc. to Semb, no. 1

Material: Stainless steel

Other Sizes:
014-0450-01 : 12 mm, 18.5 cm



Bone Surgery

Raspatory, acc. to Semb, no. 2

Material: Stainless steel

Other Sizes:
014-0450-02 : 12 mm, 21.5 cm



Bone Surgery

Raspatory, acc. to Semb, no. 3

Material: Stainless steel

Other Sizes:
014-0450-03 : 18.5 cm



Bone Surgery

Raspatory, acc. to Semb, no. 4

Material: Stainless steel

Other Sizes:
014-0450-04 : 13 mm, 21.5 cm



Bone Surgery

Raspatory, acc. to Semb, no. 5

Material: Stainless steel

Other Sizes:

014-0450-05 : 15 mm, 21 cm



Bone Surgery

Lambotte

Material: Stainless steel

Other Sizes:

014-0461-10 : 21.5 cm
 014-0461-15 : 21.5 cm
 014-0461-20 : 21.5 cm
 014-0461-25 : 21.5 cm



Bone Surgery

Bone file, half round, conic

Material: Stainless steel

Other Sizes:

014-0479-28 : 28 cm



Bone Surgery

Bone file, bayonet-shape

Material: Stainless steel

Other Sizes:

014-0481-24 : 13 mm, 25 cm



Bone Surgery

Bone file, flat

Material: Stainless steel

Other Sizes:

014-0482-22 : 20 mm, 22 cm



Bone Surgery

Elevator, acc. to Adson, straight

Material: Stainless steel

Other Sizes:

014-0484-17 : 17 cm

BONE SURGERY



Bone Surgery
Elevator, acc. to Adson, curved, round

Material: Stainless steel

Other Sizes:
014-0485-17 : 17 cm



Bone Surgery
Elevator, acc. to Adson, straight, round

Material: Stainless steel

Other Sizes:
014-0486-17 : 17.5 cm



Bone Surgery
Elevator, acc. to Adson, curved, round

Material: Stainless steel

Other Sizes:
014-0487-17 : 17 cm



Bone Surgery
Bone file, acc. to Miller-Colburn

Material: Stainless steel

Other Sizes:
014-0490-01 : 18 cm



Bone Surgery
Bone file, acc. to Miller-Colburn

Material: Stainless steel

Other Sizes:
014-0490-02 : 18 cm



Bone Surgery
Bone file, acc. to Miller-Colburn

Material: Stainless steel

Other Sizes:
014-0490-03 : 18 cm



Bone Surgery
Bone file, acc. to Miller-Colburn

Material: Stainless steel

Other Sizes:
014-0490-04 : 18 cm



Bone Surgery
Bone file, acc. to Miller-Colburn

Material: Stainless steel

Other Sizes:
014-0490-05 : 18 cm



Bone Surgery
Bone file, cross serration

Material: Stainless steel

Other Sizes:
014-0491-01 : 18 cm



Bone Surgery
Bone file, cross serration

Material: Stainless steel

Other Sizes:
014-0491-02 : 18 cm



Bone Surgery
Bone file, cross serration

Material: Stainless steel

Other Sizes:
014-0491-03 : 18 cm



Bone Surgery
Bone file, cross serration

Material: Stainless steel

Other Sizes:
014-0491-04 : 18 cm

BONE SURGERY

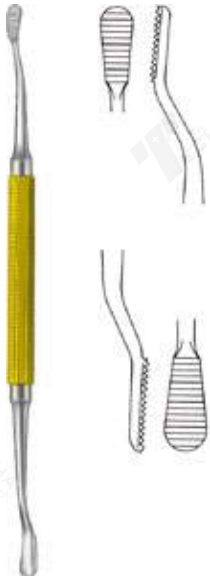

Bone Surgery

TC bone file, acc. to Miller, coarse

Material: Stainless steel

Other Sizes:

014-0492-01 : 19 cm



Bone Surgery

TC bone file, acc. to Miller, fine

Material: Stainless steel

Other Sizes:

014-0493-01 : 19 cm



Bone Surgery

Elevator, acc. to Langenbeck

Material: Stainless steel

Other Sizes:

014-0495-20 : 8 mm, 19.5 cm
014-0497-20 : 10 mm, 19.5 cm



Bone Surgery

Elevator, acc. to Martin-Langenbeck

Material: Stainless steel

Other Sizes:

014-0499-01 : 5 mm, 17 cm
014-0499-02 : 7 mm, 17 cm
014-0499-03 : 8 mm, 17 cm
014-0499-04 : 10 mm, 17 cm



Bone Surgery

Elevator, acc. to Williger

Material: Stainless steel

Other Sizes:

014-0510-17 : 17 cm



Bone Surgery

Elevator, acc. to Williger

Material: Stainless steel

Other Sizes:

014-0513-16 : 5.5 mm, 16 cm



Bone Surgery

Elevator, acc. to Sebileau

Material: Stainless steel

Other Sizes:

014-0516-18 : 5 mm, 17.5 cm



Bone Surgery

Elevator, acc. to Quervain

Material: Stainless steel

Other Sizes:

014-0517-20 : 6 mm, 19.5 cm



Bone Surgery

Dissector, acc. to Alderdyce, double-ended

Material: Stainless steel

Other Sizes:

014-0525-21 : 21 cm



Bone Surgery

Dissector, acc. to Watson-Cheyne, double-ended

Material: Stainless steel

Other Sizes:

014-0526-18 : 17.5 cm



Bone Surgery

Dissector, acc. to McDonald, double-ended

Material: Stainless steel

Other Sizes:

014-0527-19 : 18.5 cm



Bone Surgery

Bone lever, strongly curved

Material: Stainless steel

Other Sizes:

014-0537-06 : 16 cm

BONE SURGERY



Bone Surgery
Bone lever, acc.to Mini-Hohmann

Material: Stainless steel

Other Sizes:
014-0539-06 : 8 mm, 16 cm

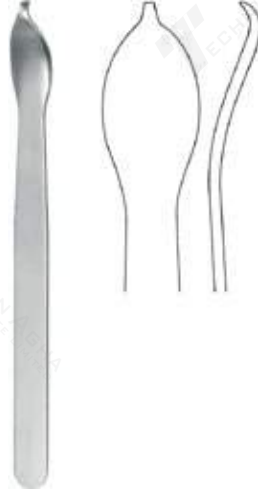

Bone Surgery
Bone lever

Material: Stainless steel

Other Sizes:
014-0539-15 : 14 mm, 16 cm



Bone Surgery
Bone lever

Material: Stainless steel

Other Sizes:
014-0539-16 : 14 mm, 12 cm



Bone Surgery
Bone lever, acc. to Hohmann

Material: Stainless steel

Other Sizes:
014-0541-08 : 22 cm



Bone Surgery
Bone lever, acc. to Hohmann

Material: Stainless steel

Other Sizes:
014-0541-18 : 23.5 cm



Bone Surgery
Bone lever, acc. to Hohmann

Material: Stainless steel

Other Sizes:
014-0541-43 : 23.5 cm



Bone Surgery

Bone lever, acc. to Hohmann

Material: Stainless steel

Other Sizes:

014-0541-70 : 25 cm



Bone Surgery

Bone lever, acc. to Hohmann

Material: Stainless steel

Other Sizes:

014-0543-43 : 23.5 cm



Bone Surgery

Bone lever, acc. to Hohmann, 22 mm

Material: Stainless steel

Other Sizes:

014-0545-22 : 25.5 cm
014-0545-35 : 29 cm



Bone Surgery

Bone lever, acc. to Hohmann,
wide round tip

Material: Stainless steel

Other Sizes:

014-0547-24 : 27.5 cm



Bone Surgery

Bone lever, acc. to Lange-Hohmann,
wide tip with groove

Material: Stainless steel

Other Sizes:

014-0549-22 : 25 cm



Bone Surgery

Bone lever, acc. to Benett

Material: steel 18/8 martinit,
antimagnetic, stainless, acid-resistant

Other Sizes:

014-0559-24 : 43 mm, 24 cm

BONE SURGERY



Bone Surgery

Bone lever, acc. to Benett

Material: Stainless steel

Other Sizes:

014-0561-24 : 60 mm, 23.5 cm



Bone Surgery

Bone lever, acc. to Blount, blunt

Material: Stainless steel

Other Sizes:

014-0563-26 : 26.5 cm



Bone Surgery

Bone lever, acc. to Blount, 2 prongs

Material: Stainless steel

Other Sizes:

014-0565-26 : 26.5 cm



Bone Surgery

Knee retractor, Benett

Material: Stainless steel

Other Sizes:

014-0567-17 : 17.5 cm



Bone Surgery

Spine retractor, acc. to Taylor

Material: Stainless steel

Other Sizes:

014-0571-16 : 95 x 30 mm, 16 cm
014-0573-16 : 115 x 30 mm, 16 cm



Bone Surgery

Meniscotome, acc. to Smillie, straight

Material: Stainless steel

Other Sizes:

014-0630-17 : 17.5 cm



Bone Surgery
Meniscotome, acc. to Smillie, right, no. 2

Material: Stainless steel

Other Sizes:
014-0631-17 : 17.5 cm



Bone Surgery
Meniscotome, acc. to Smillie, left, no. 3

Material: Stainless steel

Other Sizes:
014-0633-17 : 17.5 cm



Bone Surgery
Meniscotome, acc. to Neff

Material: Stainless steel

Other Sizes:
014-0643-22 : 22 cm (left)
014-0645-22 : 22 cm (right)



Bone Surgery
Meniscotome, acc. to Salenius, curved left

Material: Stainless steel

Other Sizes:
014-0650-22 : 21.5 cm



Bone Surgery
Meniscotome, acc. to Salenius, curved right

Material: Stainless steel

Other Sizes:
014-0651-22 : 21.5 cm



Bone Surgery
Tendon stripper, acc. to Bunnell

Material: Stainless steel

Other Sizes:
014-0652-01 : 15 cm
014-0652-02 : 15 cm
014-0652-03 : 15 cm
014-0652-04 : 15 cm
014-0652-05 : 15 cm



Bone Surgery
Tendon stripper, flexible shaft

Material: Stainless steel

Other Sizes:
014-0654-40 : 4 mm, 23 cm
014-0654-45 : 4.5 mm, 23 cm
014-0654-55 : 5.5 mm, 23 cm



Bone Surgery
Screw, for 014-0656-00

Material: Stainless steel

Other Sizes:
014-0656-01 : N/A



Bone Surgery
Tendon stripper

Material: Stainless steel

Other Sizes:
014-0662-29 : 28.5 cm



Bone Surgery
Tendon drawing probe, acc. to Bunnell, malleable

Material: Stainless steel

Other Sizes:
014-0664-23 : 23 cm



Bone Surgery
Tendon seizing forceps, acc. to Steinmann

Material: Stainless steel

Other Sizes:
014-0674-16 : 16 cm



Bone Surgery
Tendon pulling forceps, acc. to Brand

Material: Stainless steel

Other Sizes:
014-0676-15 : 15 cm
014-0676-19 : 19 cm
014-0676-24 : 24 cm



Bone Surgery
Tendon pulling forceps, straight

Material: Stainless steel

Other Sizes:
014-0678-00 : 21 cm



Bone Surgery
Tendon pulling forceps, curved

Material: Stainless steel

Other Sizes:
014-0678-01 : 20.5 cm



Bone Surgery
Tendon seizing forceps, curved

Material: Stainless steel

Other Sizes:
014-0679-11 : 11.5 cm



Bone Surgery
Tendon seizing forceps

Material: Stainless steel

Other Sizes:
014-0680-13 : 11.5 cm



Bone Surgery
Tendon seizing forceps, acc. to Kleinert-Kutz

Material: Stainless steel

Other Sizes:
014-0681-20 : 21 cm



Bone Surgery
Tendon weaving forceps, straight

Material: Stainless steel

Other Sizes:
014-0682-15 : 15 cm



Bone Surgery
Tendon weaving forceps, curved

Material: Stainless steel

Other Sizes:
014-0683-15 : 15 cm



Bone Surgery
Bone holding forceps, curved

Material: Stainless steel

Other Sizes:
014-0704-14 : 14.5 cm



Bone Surgery
Cartilage forceps, acc. to BirCher-Ganske, straight

Material: Stainless steel

Other Sizes:
014-0710-20 : 20.5 cm



Bone Surgery
Cartilage forceps, acc. to BirCher-Ganske, curved

Material: Stainless steel

Other Sizes:
014-0711-20 : 20.5 cm



Bone Surgery
Cartilage forceps, acc. to BirCher-Ganske, angled

Material: Stainless steel

Other Sizes:
014-0713-20 : 20 cm



Bone Surgery
Cartilage forceps, acc. to Dingmann

Material: Stainless steel

Other Sizes:
014-0715-19 : 18.5 cm



Bone Surgery
Reposition forceps, small

Material: Stainless steel

Other Sizes:
014-0716-12 : 13.5 cm



Bone Surgery
Cartilage forceps, acc. to Martin, straight

Material: Stainless steel

Other Sizes:
014-0716-19 : 18.5 cm



Bone Surgery
Bone holding forceps, acc. to Lewin

Material: Stainless steel

Other Sizes:
014-0718-17 : 18 cm



Bone Surgery
Phalangeal forceps, gracile

Material: Stainless steel

Other Sizes:
014-0720-14 : 14 cm



Bone Surgery
Reposition forceps, small

Material: Stainless steel

Other Sizes:
014-0721-09 : 9 cm



Bone Surgery
Reposition forceps, long ratChet

Material: Stainless steel

Other Sizes:
014-0721-14 : 15 cm



Bone Surgery
Bone holding forceps, acc. to Langenbeck

Material: Stainless steel

Other Sizes:
014-0722-21 : 21 cm



Bone Surgery
Bone holding forceps, acc. to Fergusson

Material: Stainless steel

Other Sizes:
014-0724-21 : 21 cm



Bone Surgery
Bone holding forceps, acc. to FrosCh

Material: Stainless steel

Other Sizes:
014-0726-18 : 18 cm



Bone Surgery
Reposition forceps, with thread lock

Material: Stainless steel

Other Sizes:
014-0729-16 : 17.5 cm
014-0729-24 : 24 cm

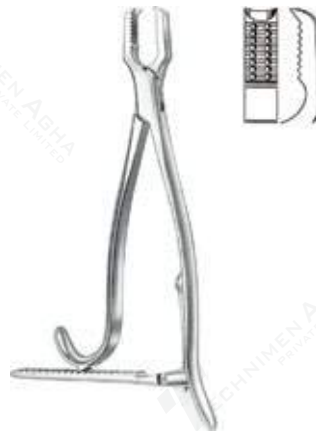

Bone Surgery
Osteotome blade, for 014-0130-00

Material: Stainless steel

Other Sizes:
014-0730-17 : 10 mm, 8 cm



Bone Surgery
Bone holding forceps, acc. to Kern

Material: Stainless steel

Other Sizes:
014-0730-21 : 21 cm



Bone Surgery

Bone holding forceps, acc. to Semb, curved

Material: Stainless steel

Other Sizes:

014-0731-19 : 19 cm



Bone Surgery

Bone holding forceps, acc. to Farabeuf

Material: Stainless steel

Other Sizes:

014-0732-23 : 23 cm
014-0732-26 : 26 cm



Bone Surgery

Bone holding forceps, acc. to Farabeuf

Material: Stainless steel

Other Sizes:

014-0734-26 : 26 cm



Bone Surgery

Lambotte, one flexible jaw

Material: Stainless steel

Other Sizes:

014-0740-22 : 22 cm
014-0740-27 : 27 cm
014-0740-30 : 30 cm

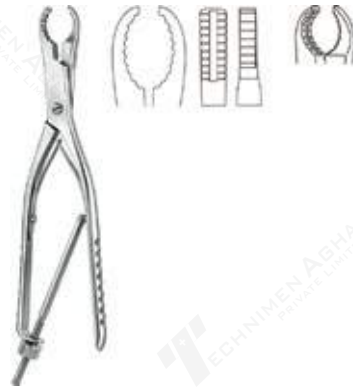

Bone Surgery

Bone holding forceps, acc. to UlriCh, straight

Material: Stainless steel

Other Sizes:

014-0746-23 : 23 cm



Bone Surgery

Bone holding forceps, acc. to UlriCh, straight

Material: Stainless steel

Other Sizes:

014-0746-23 : 23 cm
014-0746-25 : 25 cm
014-0746-28 : 28 cm



Bone Surgery

Bone holding forceps, acc. to UlriCh, curved

Material: Stainless steel

Other Sizes:

014-0747-23	22 cm
014-0747-25	24 cm
014-0747-28	27 cm



Bone Surgery

Bone holding forceps, with thread lock

Material: Stainless steel

Other Sizes:

014-0749-15	15 cm
014-0749-19	19 cm
014-0749-24	24 cm
014-0749-26	26 cm
014-0749-28	28 cm



Bone Surgery

Bone holding forceps, acc. to acc. to Lane, without lock

Material: Stainless steel

Other Sizes:

014-0750-33	33 cm
-------------	-------



Bone Surgery

Bone holding forceps, acc. to acc. to Lane, with lock

Material: Stainless steel

Other Sizes:

014-0752-33	33 cm
-------------	-------



Bone Surgery

Bone holding forceps, acc. to Verbrugge

Material: Stainless steel

Other Sizes:

014-0755-01	25 cm
014-0755-02	26 cm
014-0755-03	27 cm



Bone Surgery

Bone holding forceps, acc. to Verbrugge

Material: Stainless steel

Other Sizes:

014-0757-01	17.5 cm
-------------	---------



Bone Surgery

Bone rongeur, acc. to Stellbrink, curved

Material: Stainless steel

Other Sizes:

23-777-01-07	17.5 cm
23-777-02-07	16.5 cm



Bone Surgery

Bone rongeur, acc. to Friedman

Material: Stainless steel

Other Sizes:

014-0799-12	12.5 cm
-------------	---------



Bone Surgery

Bone rongeur, acc. to Friedman

Material: Stainless steel

Other Sizes:

014-0801-14	13.5 cm
-------------	---------



Bone Surgery

Bone rongeur, acc. to Friedman, fine

Material: Stainless steel

Other Sizes:

014-0803-14	13.5 cm
-------------	---------



Bone Surgery

Bone rongeur, acc. to Cleveland

Material: Stainless steel

Other Sizes:

014-0805-14	13.5 cm
-------------	---------



Bone Surgery

Bone rongeur, acc. to Cleveland

Material: Stainless steel

Other Sizes:

014-0807-17	16.5 cm
-------------	---------



Bone Surgery
Bone rongeur, acc. to Mead

Material: Stainless steel

Other Sizes:
014-0815-16 : 16.5 cm



Bone Surgery
Bone rongeur, acc. to Hartmann

Material: Stainless steel

Other Sizes:
014-0819-18 : 17.5 cm



Bone Surgery
Bone rongeur, acc. to Jansen, straight

Material: Stainless steel

Other Sizes:
014-0826-18 : 18 cm



Bone Surgery
Bone rongeur, acc. to Jansen, S-Shape

Material: Stainless steel

Other Sizes:
014-0828-18 : 18.5 cm



Bone Surgery
Bone rongeur, acc. to Jansen, curved

Material: Stainless steel

Other Sizes:
014-0829-18 : 18 cm



Bone Surgery
Bone rongeur, acc. to Lempert, curved

Material: Stainless steel

Other Sizes:
014-0833-19 : 19 cm



Bone Surgery
Bone rongeur, slightly curved

Material: Stainless steel

Other Sizes:
014-0835-15 : 15 cm



Bone Surgery
Bone rongeur, s-shape, 30°

Material: Stainless steel

Other Sizes:
014-0835-30 : 15.5 cm



Bone Surgery
Rongeur, acc. to Micro-Friedman, straight

Material: Stainless steel

Other Sizes:
014-0836-00 : 15.5 cm



Bone Surgery
Rongeur, acc. to Micro-Friedman, curved

Material: Stainless steel

Other Sizes:
014-0836-30 : 15.5 cm



Bone Surgery
Rongeur, acc. to Micro-Friedman, angled

Material: Stainless steel

Other Sizes:
014-0836-90 : 14,5 cm



Bone Surgery
Bone rongeur, strongly curved

Material: Stainless steel

Other Sizes:
014-0837-15 : 15 cm

BONE SURGERY



Bone Surgery

Bone rongeur, angled

Material: Stainless steel

Other Sizes:

014-0839-15 : 14 cm



Bone Surgery

Bone rongeur, acc. to Luer, straight

Material: Stainless steel

Other Sizes:

014-0846-17 : 18.5 cm



Bone Surgery

Bone rongeur, acc. to Luer, curved

Material: Stainless steel

Other Sizes:

014-0847-17 : 18 cm



Bone Surgery

Bone rongeur, acc. to Luer, curved

Material: Stainless steel

Other Sizes:

014-0853-15 : 14.5 cm



Bone Surgery

Bone rongeur, acc. to Luer, blunt curved

Material: Stainless steel

Other Sizes:

014-0864-15 : 14.5 cm



Bone Surgery

Bone rongeur, acc. to Luer, curved

Material: Stainless steel

Other Sizes:

014-0865-15 : 14.5 cm



Bone Surgery
Bone rongeur, acc. to Boehler, straight

Material: Stainless steel

Other Sizes:
014-0876-15 15.5 cm



Bone Surgery
Bone rongeur, acc. to Boehler, curved

Material: Stainless steel

Other Sizes:
014-0877-15 15.5 cm



Bone Surgery
Bone rongeur, acc. to Beyer, curved

Material: Stainless steel

Other Sizes:
014-0879-18 18 cm



Bone Surgery
Bone rongeur, acc. to Zaufal-Jansen

Material: Stainless steel

Other Sizes:
014-0881-18 18 cm



Bone Surgery
Bone rongeur, acc. to Mayfield

Material: Stainless steel

Other Sizes:
014-0883-17 18 cm



Bone Surgery
Bone rongeur, acc. to Marquard

Material: Stainless steel

Other Sizes:
014-0885-20 20.5 cm

BONE SURGERY



Bone Surgery
Bone rongeur, acc. to Ruskin, curved

Material: Stainless steel

Other Sizes:
014-0887-18 : 19 cm



Bone Surgery
Bone rongeur, acc. to Ruskin, curved

Material: Stainless steel

Other Sizes:
014-0893-23 : 24 cm



Bone Surgery
Bone rongeur, acc. to Semb, curved

Material: Stainless steel

Other Sizes:
014-0895-22 : 23.5 cm



Bone Surgery
Bone rongeur, acc. to Stille, curved

Material: Stainless steel

Other Sizes:
014-0897-23 : 22.5 cm



Bone Surgery
Bone rongeur, acc. to EChlin

Material: Stainless steel

Other Sizes:
014-0899-02 : 23 cm
014-0899-03 : 23 cm
014-0899-04 : 23 cm



Bone Surgery
Bone rongeur, acc. to Stille-Ruskin

Material: Stainless steel

Other Sizes:
014-0901-23 : 23.5 cm

BONE SURGERY



Bone Surgery
Bone rongeur, wide

Material: Stainless steel

Other Sizes:
014-0905-24 : 24.5 cm



Bone Surgery
Bone rongeur, slim

Material: Stainless steel

Other Sizes:
014-0907-24 : 24.5 cm



Bone Surgery
Bone rongeur, acc. to Frykholm, curved

Material: Stainless steel

Other Sizes:
014-0909-24 : 24.5 cm



Bone Surgery
Bone rongeur, straight

Material: Stainless steel

Other Sizes:
014-0911-22 : 22 cm



Bone Surgery
Bone rongeur, straight

Material: Stainless steel

Other Sizes:
014-0912-23 : 23 cm
014-0912-27 : 26.5 cm



Bone Surgery
Bone rongeur, curved

Material: Stainless steel

Other Sizes:
014-0913-23 : 23 cm
014-0913-27 : 26.5 cm

BONE SURGERY



Bone Surgery

Bone rongeur, acc. to SauerbruCh, straight

Material: Stainless steel

Other Sizes:

014-0916-30 : 31 cm



Bone Surgery

Bone rongeur, acc. to SauerbruCh, round

Material: Stainless steel

Other Sizes:

014-0918-30 : 31 cm



Bone Surgery

Markwalder bone nipper

Material: Stainless steel

Other Sizes:

014-0928-20 : 18.5 cm



Bone Surgery

Cottle-Kazanjian

Material: Stainless steel

Other Sizes:

014-0930-19 : 18.5 cm



Bone Surgery

23-934-14-07

Material: Stainless steel

Other Sizes:

014-0934-14 : 14 cm
014-0934-17 : 17 cm
014-0934-19 : 20 cm
014-0934-22 : 22 cm



Bone Surgery

Bone cutting forceps, acc. to Liston, curved

Material: Stainless steel

Other Sizes:

014-0935-14 : 14 cm
014-0935-17 : 17 cm
014-0935-19 : 20 cm
014-0935-22 : 22 cm



Bone Surgery

Bone cutting forceps, acc. to Cleveland

Material: Stainless steel

Other Sizes:

014-0939-17 : 17 cm



Bone Surgery

Bone cutting forceps, acc. to Cleveland

Material: Stainless steel

Other Sizes:

014-0941-15 : 14.5 cm



Bone Surgery

Bone cutting forceps, acc. to Boehler, straight

Material: Stainless steel

Other Sizes:

014-0944-15 : 14.5 cm

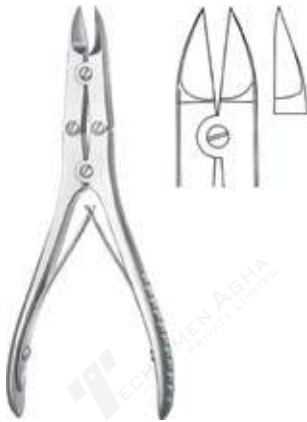

Bone Surgery

Bone cutting forceps, acc. to Boehler, curved

Material: Stainless steel

Other Sizes:

014-0946-15 : 14.5 cm



Bone Surgery

Bone cutting forceps, acc. to Cleveland, curved

Material: Stainless steel

Other Sizes:

014-0947-16 : 16 cm

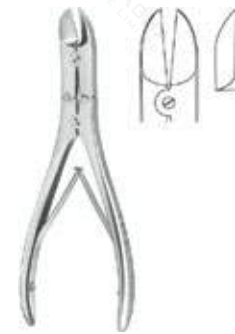

Bone Surgery

Bone cutting forceps, acc. to Ruskin, straight

Material: Stainless steel

Other Sizes:

014-0950-18 : 18 cm



Bone Surgery

Chisel blade, straight, for 014-0130-00

Material: Stainless steel

Other Sizes:

014-0951-18 : 18 cm



Bone Surgery

Bone cutting forceps, acc. to Stille-Liston

Material: Stainless steel

Other Sizes:

014-0952-27 : 26 cm



Bone Surgery

Bone cutting forceps, acc. to Stille-Liston

Material: Stainless steel

Other Sizes:

014-0954-27 : 27.5 cm



Bone Surgery

Bone cutting forceps, acc. to Stille-Liston

Material: Stainless steel

Other Sizes:

014-0955-23 : 23.5 cm
014-0955-27 : 27.5 cm



Bone Surgery

Bone cutting forceps, acc. to Liston-Key

Material: Stainless steel

Other Sizes:

014-0957-27 : 25.5 cm



Bone Surgery

Bone cutting forceps, acc. to Semb

Material: Stainless steel

Other Sizes:

014-0959-24 : 24.5 cm

BONE SURGERY



Bone Surgery
N/A

Material: Stainless steel

Other Sizes:
014-0970-17 : 18.5 cm



Bone Surgery
N/A

Material: Stainless steel

Other Sizes:
014-0972-16 : 16 cm



Bone Surgery
N/A

Material: Stainless steel

Other Sizes:
014-0973-01 : N/A



Bone Surgery
N/A

Material: Stainless steel

Other Sizes:
014-0974-01 : N/A



Bone Surgery
N/A

Material: Stainless steel

Other Sizes:
014-0975-17 : 17 cm



Bone Surgery
N/A

Material: Stainless steel

Other Sizes:
014-0976-01 : N/A

CARDIO, NEURO, LEMINECTOMY

— RANGE

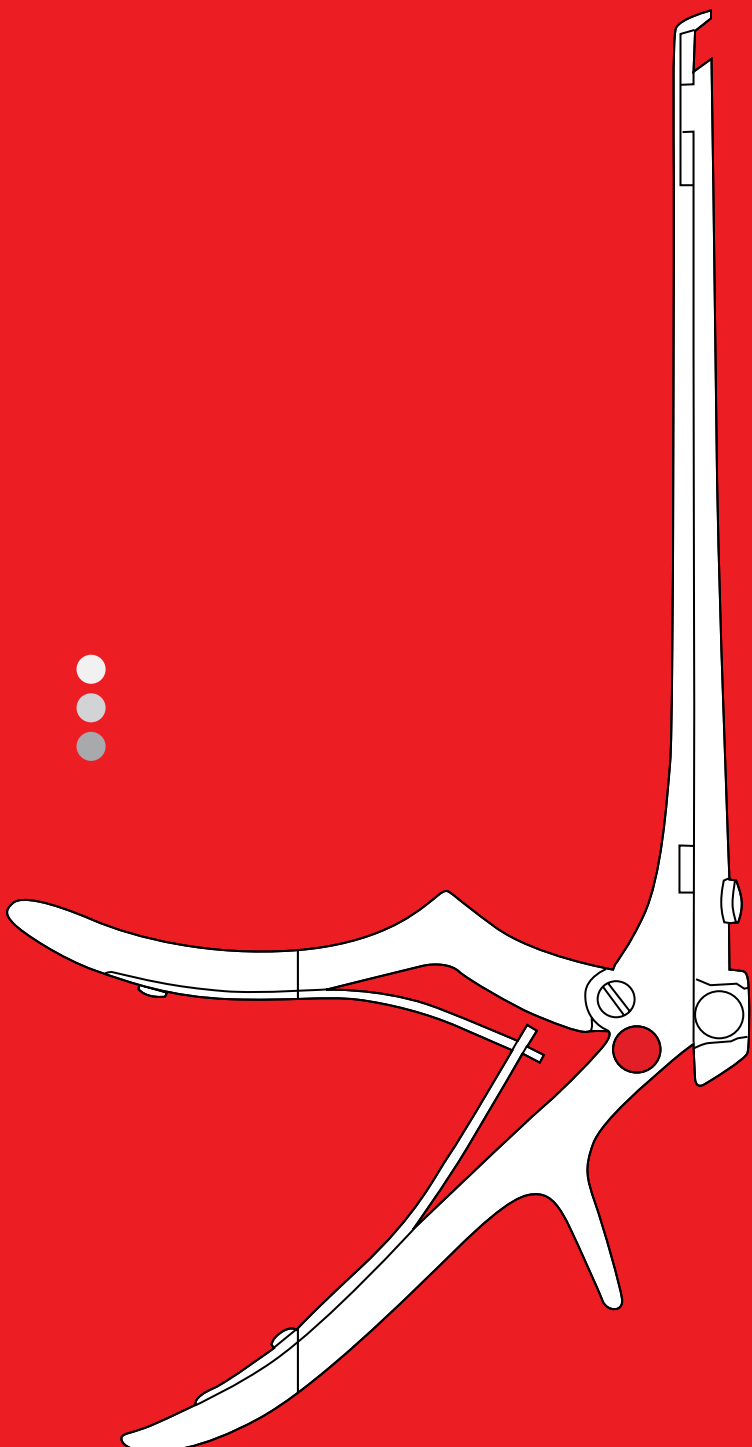

DISCOVER NOW

“Instruments for
surgical procedures”
Since 1970

CARDIO, NEURO, LEMINECTOMY



Cardio, Neuro, Leminectomy
Bone shears, straight, pointed

Material: Stainless steel

Other Sizes:
015-0100-23 : 23 cm



Cardio, Neuro, Leminectomy
Bone shears, curved

Material: Stainless steel

Other Sizes:
015-0101-22 : 23 cm



Cardio, Neuro, Leminectomy
Bone shears, acc. to Gluck, curved

Material: Stainless steel

Other Sizes:
015-0107-22 : 21 cm



Cardio, Neuro, Leminectomy
Bone shears, acc. to Bethune

Material: Stainless steel

Other Sizes:
015-0126-34 : 34.5 cm



Cardio, Neuro, Leminectomy
Bone shears, acc. to SauerbruCh

Material: Stainless steel

Other Sizes:
015-0131-26 : 26 cm



Cardio, Neuro, Leminectomy
Bone shears, acc. to Giertz-Stille

Material: Stainless steel

Other Sizes:
015-0137-27 : 24.5 cm

CARDIO, NEURO, LEMINECTOMY



Cardio, Neuro, Leminectomy

Bone shears, acc. to acc. to Brunner, right hand 32 cm

Material: Stainless steel

Other Sizes:
015-0147-28 : 32 cm



Cardio, Neuro, Leminectomy

Bone shears, acc. to acc. to Brunner, left hand

Material: Stainless steel

Other Sizes:
015-0149-28 : 32 cm



Cardio, Neuro, Leminectomy

Sternal Chisel, acc. to LebsChe

Material: Stainless steel

Other Sizes:
015-0151-24 : 24.5 cm



Cardio, Neuro, Leminectomy

Aortic punCh

Material: Stainless steel

Other Sizes:
015-0156-01 : Ø 3.0 mm, 15 cm
015-0156-02 : Ø 3.5 mm, 15 cm
015-0156-03 : Ø 4.0 mm, 15 cm
015-0156-04 : Ø 4.5 mm, 15 cm
015-0156-05 : Ø 5.0 mm, 15 cm
015-0156-06 : Ø 5.5 mm, 15 cm

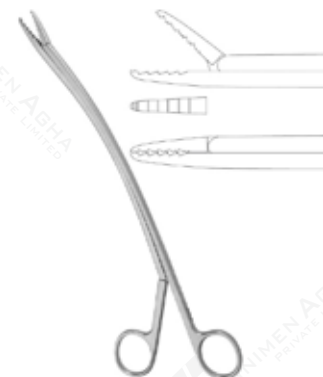

Cardio, Neuro, Leminectomy

Drainage forceps, without lock

Material: Stainless steel

Other Sizes:
015-0156-24 : 24 cm
015-0156-36 : 34 cm

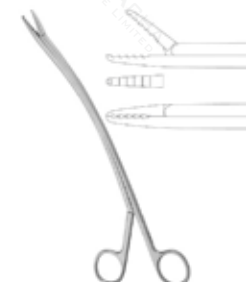

Cardio, Neuro, Leminectomy

Drainage forceps, with lock

Material: Stainless steel

Other Sizes:
015-0157-24 : 24 cm
015-0157-36 : 34 cm



Cardio, Neuro, Leminectomy
Ti sternal spreader, for premature babies

Material: Titanium

Other Sizes:

015-0159-01 : N/A



Cardio, Neuro, Leminectomy
Ti lateral blades, for 015-0159-01

Material: Titanium

Other Sizes:

015-0159-02 : 9 x 20 mm
015-0159-03 : 9 x 10 mm



Cardio, Neuro, Leminectomy
Rib spreader, acc. to Cooley, Aluminium

Material: all other, not specially marked material types

Other Sizes:

015-0160-01 : 95 mm



Cardio, Neuro, Leminectomy
Rib spreader, acc. to Cooley, Aluminium

Material: all other, not specially marked material types

Other Sizes:

015-0160-02 : 140 mm
015-0160-03 : 150 mm



Cardio, Neuro, Leminectomy
Rib spreader, acc. to Cooley, Aluminium

Material: all other, not specially marked material types

Other Sizes:

015-0160-04 : 200 mm



Cardio, Neuro, Leminectomy
Rib spreader, acc. to FinoChietto-Infant, Aluminium

Material: Stainless steel

Other Sizes:

015-0161-01 : 75 mm

CARDIO, NEURO, LEMINECTOMY



Cardio, Neuro, Leminectomy
Rib spreader, acc. to FinoChietto,
Aluminium

Material: all other, not
specially marked material types

Other Sizes:	
015-0163-01	135 mm
015-0163-02	175 mm
015-0163-03	175 mm



Cardio, Neuro, Leminectomy
Rib spreader, acc. to Burford,
Aluminium

Material: all other, not
specially marked material types

Other Sizes:	
015-0165-01	200 mm
015-0165-02	250 mm
015-0165-03	300 mm



Cardio, Neuro, Leminectomy
Rib spreader, acc. to Castaneda,
Aluminium

Material: all other, not
specially marked material types

Other Sizes:	
015-0166-01	65 mm



Cardio, Neuro, Leminectomy
Rib spreader, acc. to Castaneda,
Aluminium

Material: Stainless steel

Other Sizes:	
015-0166-02	70 mm



Cardio, Neuro, Leminectomy
Rib spreader, acc. to Castaneda,
Aluminium

Material: all other, not
specially marked material types

Other Sizes:	
015-0166-03	120 mm



Cardio, Neuro, Leminectomy
Rib spreader, acc. to FinoChietto,
Aluminium

Material: Stainless steel

Other Sizes:	
015-0167-01	120 mm

CARDIO, NEURO, LEMINECTOMY



Cardio, Neuro, Leminectomy
Rib spreader, acc. to Haight,

Material: Stainless steel

Other Sizes:
015-0168-90 30 x 30 x 120 mm



Cardio, Neuro, Leminectomy
Rib spreader, acc. to Morse-Favaloro,
Aluminium

Material: all other, not
specially marked material types

Other Sizes:
015-0169-01 160 mm



Cardio, Neuro, Leminectomy
Sternum retractor, acc. to Morse

Material: Stainless steel

Other Sizes:
015-0170-00 200 mm
015-0171-00 212 mm



Cardio, Neuro, Leminectomy
Rib spreader, acc. to Tuffier

Material: Stainless steel

Other Sizes:
015-0174-02 160 mm



Cardio, Neuro, Leminectomy
Rib spreader, acc. to FinoChietto-Baby

Material: Stainless steel

Other Sizes:
015-0177-75 75 mm



Cardio, Neuro, Leminectomy
Rib Spreader, acc. to FinoChietto

Material: Stainless steel

Other Sizes:
015-0178-01 150 mm
015-0178-02 190 mm
015-0178-03 190 mm

CARDIO, NEURO, LEMINECTOMY



Cardio, Neuro, Leminectomy
Rib Spreader, acc. to De Bakey,
small, complete

Material: Stainless steel

Other Sizes:

015-0179-00	150 mm
015-0179-01	150 mm



Cardio, Neuro, Leminectomy
Lateral blades, acc. to De Bakey

Material: Stainless steel

Other Sizes:

015-0179-02	30 x 30 mm
015-0179-03	40 x 40 mm
015-0179-04	50 x 50 mm



Cardio, Neuro, Leminectomy
Rib spreader, acc. to De Bakey,
large, complete

Material: Stainless steel

Other Sizes:

015-0180-00	N/A
-------------	-----



Cardio, Neuro, Leminectomy
Lateral blades, acc. to De Bakey, pair

Material: Stainless steel

Other Sizes:

015-0180-02	60 x 60 mm
015-0180-03	50 x 80 mm
015-0180-04	40 x 100 mm
015-0180-05	80 x 80 mm
015-0180-06	50 x 65 mm



Cardio, Neuro, Leminectomy
Retractor, acc. to De Bakey, small, com

Material: Stainless steel

Other Sizes:

015-0181-00	152 x 144 mm
-------------	--------------



Cardio, Neuro, Leminectomy
Lateral blades, for 015-0181-01

Material: octagonal handle

Other Sizes:

015-0181-02	30 x 30 mm
015-0181-03	40 x 40 mm
015-0181-04	50 x 50 mm

CARDIO, NEURO, LEMINECTOMY



Cardio, Neuro, Leminectomy

Retractor, acc. to De Bakey,
large, complete

Material: Stainless steel

Other Sizes:

015-0182-00 241 x 189 mm



Cardio, Neuro, Leminectomy

Lateral blades, for 015-0182-01

Material: Stainless steel

Other Sizes:

015-0182-02	60 x 60 mm
015-0182-03	50 x 80 mm
015-0182-04	40 x 100 mm
015-0182-05	80 x 60 mm
015-0182-06	50 x 85 mm



Cardio, Neuro, Leminectomy

Sternal Retractor, Dubost, 3 pairs of blades

Material: Stainless steel

Other Sizes:

015-0183-00 N/A



Cardio, Neuro, Leminectomy

Sternal Retractor, Dubost, blades
and IMA configuration

Material: Stainless steel

Other Sizes:

015-0183-01 N/A



Cardio, Neuro, Leminectomy

Lateral blades, for 015-0183-02-07

Material: Stainless steel

Other Sizes:

015-0183-03	30 x 100 mm
015-0183-04	40 x 100 mm
015-0183-05	50 x 100 mm



Cardio, Neuro, Leminectomy

IMA blade, for 015-0183-02

Material: Stainless steel

Other Sizes:

015-0183-06 N/A



Cardio, neuro, Leminectomy
IMA adaptor for 015-0183-02

Material: Stainless steel

Other Sizes:
015-0183-07 : N/A



Cardio, Neuro, Leminectomy
IMA sternal retractor

Material: Stainless steel

Other Sizes:
015-0184-00 : 134 x 195 mm



Cardio, Neuro, Leminectomy
Mini thoracotomy retractor, 2 pairs valves

Material: Stainless steel

Other Sizes:
015-0185-00 : N/A



Cardio, Neuro, Leminectomy
Mini thoracotomy frame

Material: Stainless steel

Other Sizes:
015-0185-01 : N/A



Cardio, Neuro, Leminectomy
Mini-Thoracotomy Retractor, 2 pairs valves

Material: Stainless steel

Other Sizes:
015-0185-02 : N/A



Cardio, Neuro, Leminectomy
2 valves for 015-0185-01

Material: Stainless steel

Other Sizes:
015-0185-04 : 40 x 36 mm
015-0185-05 : 55 x 36 mm

CARDIO, NEURO, LEMINECTOMY



Cardio, Neuro, Leminectomy
Mini thoracic retractor, with bar

Material: Stainless steel

Other Sizes:

015-0186-00	45 x 36 mm
015-0186-01	60 x 36 mm
015-0186-02	80 x 36 mm



Cardio, Neuro, Leminectomy
Mini thoracotomy retractor

Material: Stainless steel

Other Sizes:

015-0186-03	45 x 36 mm
015-0186-04	60 x 36 mm
015-0186-05	80 x 36 mm



Cardio, Neuro, Leminectomy
Bar for mini thoracotomy retractor

Material: Stainless steel

Other Sizes:

015-0186-06	N/A
-------------	-----

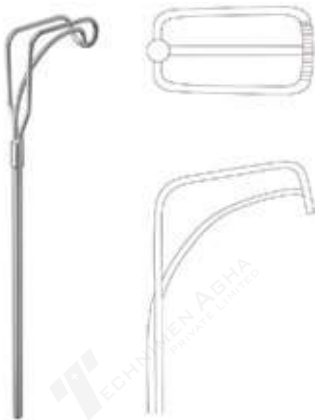

Cardio, Neuro, Leminectomy
Wire valve, acc. to Cooley, small

Material: Stainless steel

Other Sizes:

015-0187-01	35 x 25 mm
015-0187-03	40 x 36 mm
015-0187-05	50 x 36 mm



Cardio, Neuro, Leminectomy
Fixation element universal

Material: Stainless steel

Other Sizes:

015-0187-02	Ø 6 mm
-------------	--------



Cardio, Neuro, Leminectomy
Malleable blade

Material: Stainless steel

Other Sizes:

015-0187-05	76 x 25 mm
-------------	------------

CARDIO, NEURO, LEMINECTOMY



Cardio, Neuro, Leminectomy
IMA sternum retractor, frenCh model,
complete

Material: Stainless steel

Other Sizes:
015-0188-00 N/A



Cardio, Neuro, Leminectomy
Blade, for 015-0188-01

Material: Stainless steel

Other Sizes:
015-0188-02 30 x 100 mm



Cardio, Neuro, Leminectomy
Blade, for 015-0188-01

Material: Stainless steel

Other Sizes:
015-0188-03 50 x 22 mm
015-0188-04 40 x 22 mm



Cardio, Neuro, Leminectomy
Sternum retractor, marGate, complete

Material: Stainless steel

Other Sizes:
015-0189-00 280 mm



Cardio, Neuro, Leminectomy
Frame for sternal Spreader 015-0189-00

Material: Stainless steel

Other Sizes:
015-0189-01 N/A



Cardio, Neuro, Leminectomy
Sternal blade, for 015-0189-00,

Material: Stainless steel

Other Sizes:
015-0189-02 100 x 30 mm
015-0189-03 100 x 40 mm

CARDIO, NEURO, LEMINECTOMY



Cardio, Neuro, Leminectomy
Sternal blade, for 015-0189-00,

Material: Stainless steel

Other Sizes:

015-0189-04	28 x 30 mm
015-0189-05	28 x 40 mm



Cardio, Neuro, Leminectomy
Holding clamp, for 015-0189-00

Material: Stainless steel

Other Sizes:

015-0189-09	N/A
-------------	-----



Cardio, Neuro, Leminectomy
Atrial retractor, acc. to Cooley, malleable

Material: Stainless steel

Other Sizes:

015-0189-10	60 x 20 mm
015-0189-11	60 x 35 mm
015-0189-12	60 x 45 mm



Cardio, Neuro, Leminectomy
Valve hook, malleable

Material: Stainless steel

Other Sizes:

015-0189-20	18 x 65 mm
015-0189-21	18 x 95 mm
015-0189-22	18 x 95 mm
015-0189-23	18 x 75 mm



Cardio, Neuro, Leminectomy
Valve hook, Nitinol

Material: all other, not specially marked material types

Other Sizes:

015-0189-20n	18 x 65 mm
015-0189-21n	18 x 95 mm
015-0189-22n	18 x 95 mm
015-0189-23n	18 x 75 mm



Cardio, Neuro, Leminectomy
N/A

Material: Stainless steel

Other Sizes:

015-0191-00	N/A
015-0191-01	N/A

CARDIO, NEURO, LEMINECTOMY



Cardio, Neuro, Leminectomy
N/A

Material: Stainless steel

Other Sizes:

015-0191-65	48x68 mm
015-0191-75	70x75 mm



Cardio, Neuro, Leminectomy
Rib contractor and distractor, acc. to Sellors

Material: Stainless steel

Other Sizes:

015-0218-19	20 cm
-------------	-------



Cardio, Neuro, Leminectomy
Rib contractor, acc. to Bailey

Material: Stainless steel

Other Sizes:

015-0220-14	15.5 cm
-------------	---------



Cardio, Neuro, Leminectomy
Rib contractor, acc. to Bailey

Material: Stainless steel

Other Sizes:

015-0224-16	20 cm
-------------	-------



Cardio, Neuro, Leminectomy
Rib contractor, acc. to Bailey-Gibbon

Material: Stainless steel

Other Sizes:

015-0226-16	20 cm
-------------	-------



Cardio, Neuro, Leminectomy
Coronary spreader, 1 x 1

Material: Stainless steel

Other Sizes:

015-0230-02	25 mm
-------------	-------

CARDIO, NEURO, LEMINECTOMY



Cardio, Neuro, Leminectomy
Coronary spreader, 3 x 3

Material: Stainless steel

Other Sizes:
015-0230-03 35 mm

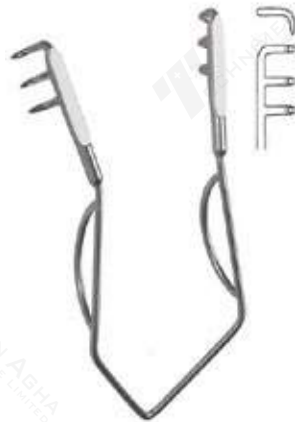

Cardio, Neuro, Leminectomy
Coronary spreader, 3 x 3

Material: Stainless steel

Other Sizes:
015-0230-04 40 mm
015-0230-05 50 mm



Cardio, Neuro, Leminectomy
Lung spatula, acc. to acc. to Allison

Material: steel 18/8 martinit,
antimagnetic, stainless, acid-resistant

Other Sizes:
015-0231-30 29.5 cm
015-0231-32 33 cm



Cardio, Neuro, Leminectomy
Lung spatula, extra wide

Material: Stainless steel

Other Sizes:
015-0233-30 29.5 cm



Cardio, Neuro, Leminectomy
BronChus forceps, acc. to Price-Thomas

Material: Stainless steel

Other Sizes:
015-0241-22 22 cm



Cardio, Neuro, Leminectomy
BronChus forceps, acc. to Price-Thomas, no. 1

Material: Stainless steel

Other Sizes:
015-0245-22 22 cm

CARDIO, NEURO, LEMINECTOMY



Cardio, Neuro, Leminectomy
BronChus forceps, acc. to Price-Thomas, no. 2

Material: Stainless steel

Other Sizes:
015-0247-22 : 22 cm



Cardio, Neuro, Leminectomy
BronChus forceps, acc. to Semb, slightly curved,

Material: Stainless steel

Other Sizes:
015-0265-24 : 25 cm



Cardio, Neuro, Leminectomy
BronChus forceps, acc. to Semb, strongly curved

Material: Stainless steel

Other Sizes:
015-0267-24 : 24.5 cm



Cardio, Neuro, Leminectomy
Ti shunt bulldog clamp

Material: Stainless steel

Other Sizes:
015-0280-10 : 10°, 75 mm
015-0280-25 : 25°, 75 mm
015-0280-45 : 45°, 70 mm
015-0280-60 : 60°, 65 mm



Cardio, Neuro, Leminectomy
Ti shunt bulldog clamp, 12 Ch

Material: Stainless steel

Other Sizes:
015-0281-10 : 10°, 75 mm
015-0281-25 : 25°, 75 mm
015-0281-45 : 45°, 70 mm
015-0281-60 : 60°, 65 mm



Cardio, Neuro, Leminectomy
Ti shunt bulldog clamp, 14 Ch

Material: Stainless steel

Other Sizes:
015-0282-10 : 10°, 75 mm
015-0282-25 : 25°, 75 mm
015-0282-45 : 45°, 70 mm
015-0282-60 : 60°, 65 mm



Cardio, Neuro, Leminectomy

Lung grasping forceps, acc. to Lovelace, straight

Material: Stainless steel

Other Sizes:

015-0286-20 : 20.5 cm



Cardio, Neuro, Leminectomy

Lung grasping forceps, acc. to Lovelace, curved

Material: Stainless steel

Other Sizes:

015-0287-20 : 19 cm



Cardio, Neuro, Leminectomy

Ti bulldog clamp, acc. to De Bakey, straight,

Material: Stainless steel

Other Sizes:

015-0288-07 : 80 mm
015-0288-08 : 90 mm
015-0288-09 : 110 mm
015-0288-10 : 130 mm



Cardio, Neuro, Leminectomy

Ti bulldog clamp, acc. to De Bakey, straight

Material: Stainless steel

Other Sizes:

015-0289-07 : 8 cm
015-0289-08 : 9 cm
015-0289-09 : 10 cm
015-0289-10 : 11.5 cm



Cardio, Neuro, Leminectomy

Bulldog clamp, acc. to De Bakey-Satinsky

Material: Stainless steel

Other Sizes:

015-0291-07 : 7 cm



Cardio, Neuro, Leminectomy

Bulldog clamp, acc. to De Bakey-Satinsky

Material: Stainless steel

Other Sizes:

015-0291-09 : 9 cm

CARDIO, NEURO, LEMINECTOMY



Cardio, Neuro, Leminectomy
Bulldog clamp, acc. to De Bakey-Satinsky

Material: Stainless steel

Other Sizes:
015-0291-10 : 10 cm



Cardio, Neuro, Leminectomy
Bulldog clamp, acc. to Glover, angled

Material: Stainless steel

Other Sizes:
015-0293-06 : 6 cm
015-0293-07 : 8 cm
015-0293-08 : 8.5 cm
015-0293-10 : 9.5 cm
015-0293-12 : 11.5 cm



Cardio, Neuro, Leminectomy
Bulldog clamp, acc. to Santulli, angled

Material: Stainless steel

Other Sizes:
015-0295-07 : 7 cm



Cardio, Neuro, Leminectomy
Bulldog clamp, acc. to Gregory-soft

Material: Stainless steel

Other Sizes:
015-0297-09 : 9 cm
015-0297-11 : 11 cm



Cardio, Neuro, Leminectomy
Bulldog clamp, acc. to Gregory, left

Material: Stainless steel

Other Sizes:
015-0299-01 : 10.5 cm



Cardio, Neuro, Leminectomy
Bulldog clamp, acc. to Gregory, right

Material: Stainless steel

Other Sizes:
015-0299-02 : 10.5 cm



Cardio, Neuro, Leminectomy
Atraumatic forceps, acc. to Rankin, straight

Material: Stainless steel

Other Sizes:
015-0300-16 16 cm



Cardio, Neuro, Leminectomy
Atraumatic forceps, acc. to Rankin, curved

Material: Stainless steel

Other Sizes:
015-0301-16 16 cm



Cardio, Neuro, Leminectomy
Atraumatic forceps, acc. to Mosquito, straight

Material: Stainless steel

Other Sizes:
015-0302-15 15 cm



Cardio, Neuro, Leminectomy
Atraumatic forceps, acc. to Mosquito, curved

Material: Stainless steel

Other Sizes:
015-0303-15 15 cm



Cardio, Neuro, Leminectomy
Atraumatic forceps, acc. to Ochsner, curved

Material: Stainless steel

Other Sizes:
015-0317-23 23.5 cm



Cardio, Neuro, Leminectomy
Atraumatic forceps, acc. to Diethrich, curved

Material: Stainless steel

Other Sizes:
015-0319-21 22 cm

CARDIO, NEURO, LEMINECTOMY



Cardio, Neuro, Leminectomy

Atraumatic vascular forceps, acc. to Dardik, straight

Material: Stainless steel

Other Sizes:

015-0336-00 : 15 cm



Cardio, Neuro, Leminectomy

Atraumatic vascular forceps, acc. to Dardik, 15°

Material: Stainless steel

Other Sizes:

015-0336-15 : 15 cm



Cardio, Neuro, Leminectomy

Atraumatic vascular forceps, acc. to Dardik, 30°

Material: Stainless steel

Other Sizes:

015-0336-30 : 15 cm



Cardio, Neuro, Leminectomy

Atraumatic vascular forceps, acc. to Dardik, 45°

Material: Stainless steel

Other Sizes:

015-0336-45 : 15 cm



Cardio, Neuro, Leminectomy

Atraumatic vascular forceps, acc. to Dardik, 90°

Material: Stainless steel

Other Sizes:

015-0336-90 : 15 cm



Cardio, Neuro, Leminectomy

Atraumatic vascular forceps, acc. to Dardik, straight

Material: Stainless steel

Other Sizes:

015-0338-00 : 17 cm

CARDIO, NEURO, LEMINECTOMY



Cardio, Neuro, Leminectomy
Atraumatic vascular forceps, acc.
to Dardik

Material: Stainless steel

Other Sizes:
015-0338-15 17 cm



Cardio, Neuro, Leminectomy
Atraumatic vascular forceps, acc.
to Dardik, 30°

Material: Stainless steel

Other Sizes:
015-0338-30 17 cm



Cardio, Neuro, Leminectomy
Atraumatic vascular forceps, acc.
to Dardik, 45°

Material: Stainless steel

Other Sizes:
015-0338-45 17 cm



Cardio, Neuro, Leminectomy
Atraumatic vascular forceps, acc.
to Dardik, 90°

Material: Stainless steel

Other Sizes:
015-0338-90 15 cm



Cardio, Neuro, Leminectomy
Atraumatic forceps, acc. to Dale, curved

Material: Stainless steel

Other Sizes:
015-0340-18 18 cm



Cardio, Neuro, Leminectomy
Atraumatic forceps, acc. to Dale

Material: Stainless steel

Other Sizes:
015-0341-17 17.5 cm
015-0341-18 18 cm
015-0341-19 17.5 cm



Cardio, Neuro, Leminectomy

Atraumatic profunda clamp, acc. to Gregory

Material: Stainless steel

Other Sizes:

015-0342-14 : 13.5 cm



Cardio, Neuro, Leminectomy

Atraumatic profunda clamp, acc. to Gregory

Material: Stainless steel

Other Sizes:

015-0342-16 : 13 cm



Cardio, Neuro, Leminectomy

Atraumatic profunda clamp, acc. to Gregory

Material: Stainless steel

Other Sizes:

015-0342-18 : 18 cm

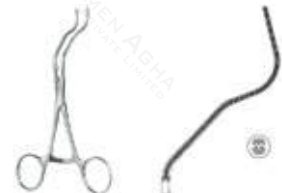

Cardio, Neuro, Leminectomy

Carotid clamps, acc. to Javid, short, curved

Material: Stainless steel

Other Sizes:

015-0343-18 : 17.5 cm



Cardio, Neuro, Leminectomy

Carotid clamps, acc. to Javid, long, curved

Material: Stainless steel

Other Sizes:

015-0343-19 : 18.5 cm



Cardio, Neuro, Leminectomy

Atraumatic forceps, acc. to Martin-Peripheral

Material: Stainless steel

Other Sizes:

015-0344-16 : 16 cm
015-0344-17 : 16.5 cm



CARDIO, NEURO, LEMINECTOMY



Cardio, Neuro, Leminectomy
Atraumatic forceps, acc. to Martin-Peripheral

Material: Stainless steel

Other Sizes:
015-0344-18 : 18 cm
015-0344-20 : 19 cm



Cardio, Neuro, Leminectomy
Atraumatic aorta forceps, acc. to Wylie

Material: Stainless steel

Other Sizes:
015-0344-24 : 24 cm



Cardio, Neuro, Leminectomy
Atraumatic aorta forceps, acc. to Wylie

Material: Stainless steel

Other Sizes:
015-0344-27 : 27 cm



Cardio, Neuro, Leminectomy
Atraumatic aorta forceps, acc. to De Baakey

Material: Stainless steel

Other Sizes:
015-0344-30 : 30 cm



Cardio, Neuro, Leminectomy
Atraumatic forceps, acc. to Husfeldt-Peripheral

Material: Stainless steel

Other Sizes:
015-0345-18 : 17.5 cm



Cardio, Neuro, Leminectomy
Atraumatic forceps, acc. to Husfeldt-Peripheral

Material: Stainless steel

Other Sizes:
015-0347-18 : 18 cm

CARDIO, NEURO, LEMINECTOMY



Cardio, Neuro, Leminectomy

Atraumatic forceps, acc. to Husfeldt-Peripher

Material: Stainless steel

Other Sizes:

015-0349-17 : 17 cm



Cardio, Neuro, Leminectomy

Vascular caliper, acc. to Martin

Material: Stainless steel

Other Sizes:

015-0349-18 : 17 cm

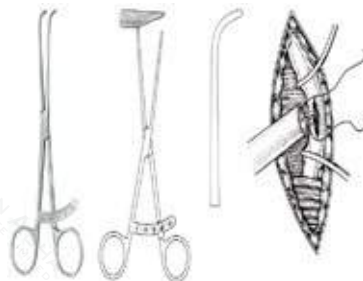

Cardio, Neuro, Leminectomy

Atraumatic subclavian forceps, acc. to Henly

Material: Stainless steel

Other Sizes:

015-0349-20 : 20 cm



Cardio, Neuro, Leminectomy

Catheter forceps, acc. to Cooley

Material: Stainless steel

Other Sizes:

015-0350-04 : 20 cm
015-0350-05 : 20 cm
015-0350-07 : 20 cm
015-0350-08 : 20 cm
015-0350-09 : 20 cm



Cardio, Neuro, Leminectomy

Atraumatic abdominal aortic forceps, acc. to Zanger

Material: Stainless steel

Other Sizes:

015-0352-22 : 21.5 cm
015-0352-25 : 25 cm
015-0352-31 : 30.5 cm



Cardio, Neuro, Leminectomy

Atraumatic abdominal aortic forceps, acc. to Grant

Material: Stainless steel

Other Sizes:

015-0353-25 : 24.5 cm



Cardio, Neuro, Leminectomy

Atraumatic aortic forceps, acc. to Cooley

Material: Stainless steel

Other Sizes:

015-0354-19	19 cm
015-0354-27	26.5 cm
015-0354-34	33.5 cm



Cardio, Neuro, Leminectomy

Atraumatic aortic forceps, acc. to Cooley

Material: Stainless steel

Other Sizes:

015-0354-26	26 cm
-------------	-------



Cardio, Neuro, Leminectomy

Atraumatic aortic forceps, acc. to Cooley

Material: Stainless steel

Other Sizes:

015-0354-32	31.5 cm
-------------	---------



Cardio, Neuro, Leminectomy

Atraumatic forceps, acc. to De Bakey,
2.7 mm

Material: Stainless steel

Other Sizes:

015-0384-16	16 cm
015-0384-20	20 cm
015-0384-24	24 cm
015-0384-30	30 cm



Cardio, Neuro, Leminectomy

Atraumatic forceps, acc. to De Bakey

Material: Stainless steel

Other Sizes:

015-0386-16	16 cm
015-0386-20	20 cm
015-0386-24	24.5 cm



Cardio, Neuro, Leminectomy

Atraumatic forceps, acc. to De Bakey,
2 mm

Material: Stainless steel

Other Sizes:

015-0388-16	16 cm
015-0388-20	20 cm
015-0388-24	24 cm
015-0388-30	30 cm

CARDIO, NEURO, LEMINECTOMY



Cardio, Neuro, Leminectomy

Atraumatic forceps, acc. to De Bakey, angled, 2 mm

Material: Stainless steel

Other Sizes:

015-0389-16	16 cm
015-0389-20	19.5 cm
015-0389-24	24.5 cm
015-0389-30	29.5 cm



Cardio, Neuro, Leminectomy

Atraumatic forceps, acc. to De Bakey, 3.5 mm

Material: Stainless steel

Other Sizes:

015-0390-16	16 cm
015-0390-20	20 cm
015-0390-24	24 cm
015-0390-30	30 cm



Cardio, Neuro, Leminectomy

Bulldog clamp, acc. to De Bakey, straight

Material: Stainless steel

Other Sizes:

015-0392-07	8.1 cm
015-0392-08	9 cm
015-0392-10	10.5 cm
015-0392-12	12.5 cm



Cardio, Neuro, Leminectomy

Bulldog clamp, acc. to De Bakey, straight

Material: Stainless steel

Other Sizes:

015-0392-07	7.5 cm
015-0392-08	8.5 cm
015-0392-10	10 cm
015-0392-12	12 cm



Cardio, Neuro, Leminectomy

Bulldog clamp, acc. to De Bakey, curved

Material: Stainless steel

Other Sizes:

015-0393-07	7.5 cm
015-0393-08	8.5 cm
015-0393-10	9.5 cm
015-0393-12	11 cm



Cardio, Neuro, Leminectomy

Bulldog clamp, Gregory-style, right

Material: Stainless steel

Other Sizes:

015-0394-01	9.5 cm
-------------	--------



Cardio, Neuro, Leminectomy
Bulldog clamp, Gregory-style, left

Material: Stainless steel

Other Sizes:
015-0394-02 : 9.5 cm



Cardio, Neuro, Leminectomy
Applying forceps for bulldog clamps

Material: Stainless steel

Other Sizes:
015-0395-23 : 23.5 cm



Cardio, Neuro, Leminectomy
Bulldog clamp, acc. to Glover, straight

Material: Stainless steel

Other Sizes:
015-0398-06 : 7 cm
015-0398-07 : 8 cm
015-0398-09 : 9.5 cm
015-0398-11 : 11 cm



Cardio, Neuro, Leminectomy
Bulldog clamp, acc. to Glover, curved

Material: Stainless steel

Other Sizes:
015-0399-06 : 6.5 cm
015-0399-07 : 7.5 cm
015-0399-09 : 9 cm
015-0399-11 : 10.5 cm



Cardio, Neuro, Leminectomy
Atraumatic forceps, acc. to Potts,
straight, 30 mm

Material: Stainless steel

Other Sizes:
015-0400-21 : 21 cm



Cardio, Neuro, Leminectomy
Atraumatic forceps, acc. to Potts,
straight, 55 mm

Material: Stainless steel

Other Sizes:
015-0400-22 : 22.5 cm

CARDIO, NEURO, LEMINECTOMY



Cardio, Neuro, Leminectomy
Atraumatic forceps, acc. to Potts,
angled, 30 mm

Material: Stainless steel

Other Sizes:

015-0401-21 : 20 cm



Cardio, Neuro, Leminectomy
Atraumatic forceps, acc. to Potts,
angled, 55 mm

Material: Stainless steel

Other Sizes:

015-0401-22 : 22 cm



Cardio, Neuro, Leminectomy
Atraumatic forceps, acc. to Potts,
angled, 30 mm

Material: Stainless steel

Other Sizes:

015-0403-21 : 20.5 cm



Cardio, Neuro, Leminectomy
Atraumatic forceps, acc. to Potts,
angled, 55 mm

Material: Stainless steel

Other Sizes:

015-0403-22 : 22 cm



Cardio, Neuro, Leminectomy
Atraumatic forceps, acc. to Potts,
curved, 55 mm

Material: Stainless steel

Other Sizes:

015-0405-22 : 21.5 cm



Cardio, Neuro, Leminectomy
Atraumatic forceps, acc. to Potts,
curved, 55 mm

Material: Stainless steel

Other Sizes:

015-0407-22 : 22 cm



Cardio, Neuro, Leminectomy
Atraumatic ligature forceps, acc. to De Bakey

Material: Stainless steel

Other Sizes:

015-0408-19 : 19 cm
015-0408-23 : 24 cm



Cardio, Neuro, Leminectomy
Atraumatic forceps, acc. to De Bakey, curved

Material: Stainless steel

Other Sizes:

015-0409-16 : 16 cm



Cardio, Neuro, Leminectomy
Atraumatic forceps, acc. to De Bakey, s-shape

Material: Stainless steel

Other Sizes:

015-0411-19 : 19 cm



Cardio, Neuro, Leminectomy
Atraumatic forceps, acc. to De Bakey, s-shape

Material: Stainless steel

Other Sizes:

015-0411-20 : 19.5 cm



Cardio, Neuro, Leminectomy
Atraumatic forceps, acc. to Leland-Jones, angled

Material: Stainless steel

Other Sizes:

015-0413-18 : 18 cm



Cardio, Neuro, Leminectomy
Atraumatic forceps, acc. to Leland-Jones, angled

Material: Stainless steel

Other Sizes:

015-0413-19 : 18.5 cm

CARDIO, NEURO, LEMINECTOMY



Cardio, Neuro, Leminectomy
Atraumatic forceps, acc. to Leland-Jones, angled

Material: Stainless steel

Other Sizes:
015-0413-20 19.5 cm



Cardio, Neuro, Leminectomy
Atraumatic forceps, acc. to Bainbridge, straight

Material: Stainless steel

Other Sizes:
015-0414-15 15 cm
015-0414-18 18.5 cm



Cardio, Neuro, Leminectomy
Atraumatic forceps, acc. to Bainbridge, curved

Material: Stainless steel

Other Sizes:
015-0415-15 15 cm
015-0415-18 18.5 cm



Cardio, Neuro, Leminectomy
Atraumatic forceps, acc. to De Bakay, angled

Material: Stainless steel

Other Sizes:
015-0416-20 20 cm



Cardio, Neuro, Leminectomy
Atraumatic aneurysm forceps, acc. to De Bakay

Material: Stainless steel

Other Sizes:
015-0417-26 26 cm
015-0417-27 27 cm
015-0417-31 31 cm
015-0417-33 33 cm



Cardio, Neuro, Leminectomy
Atraumatic aneurysm forceps, acc. to De Bakay

Material: Stainless steel

Other Sizes:
015-0418-28 28 cm

CARDIO, NEURO, LEMINECTOMY



Cardio, Neuro, Leminectomy
Aneurysm forceps, acc. to De Bakey,
s-shape

Material: Stainless steel

Other Sizes:
015-0419-30 : 30 cm



Cardio, Neuro, Leminectomy
Atraumatic aorta forceps, acc. to Cooley

Material: Stainless steel

Other Sizes:
015-0420-25 : 25 cm



Cardio, Neuro, Leminectomy
Atraumatic aorta forceps, acc.
to De Bakey,

Material: Stainless steel

Other Sizes:
015-0420-27 : 27 cm



Cardio, Neuro, Leminectomy
Ligature forceps, acc. to De Bakey,
s-shape

Material: Stainless steel

Other Sizes:
015-0421-24 : 24.5 cm



Cardio, Neuro, Leminectomy
Ligature forceps, acc. to De Bakey,
s-shape

Material: Stainless steel

Other Sizes:
015-0422-24 : 24.5 cm



Cardio, Neuro, Leminectomy
Ligature forceps, acc. to De Bakey,
s-shape

Material: Stainless steel

Other Sizes:
015-0423-25 : 27 cm



Cardio, Neuro, Leminectomy
Ligature forceps, acc. to De Bakey,
s-shape

Material: Stainless steel

Other Sizes:
015-0423-26 : 27 cm



Cardio, Neuro, Leminectomy
Atraumatic aorta forceps, acc.
to Weber, left

Material: Stainless steel

Other Sizes:
015-0424-01 : 24 cm



Cardio, Neuro, Leminectomy
Atraumatic aorta forceps, acc.
to Weber, right

Material: Stainless steel

Other Sizes:
015-0424-02 : 24 cm

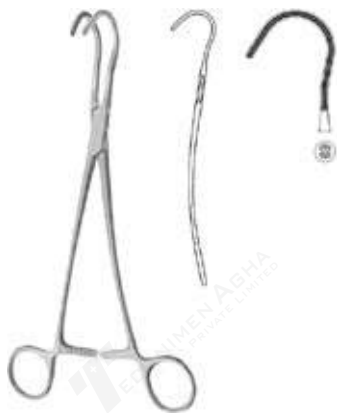

Cardio, Neuro, Leminectomy
Atraumatic aorta forceps, acc. to Wylie

Material: Stainless steel

Other Sizes:
015-0424-03 : 22.5 cm

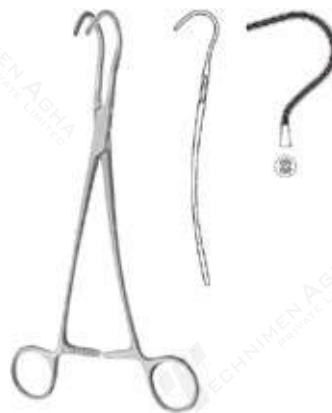

Cardio, Neuro, Leminectomy
Atraumatic aorta forceps, acc. to Wylie

Material: Stainless steel

Other Sizes:
015-0424-04 : 23 cm



Cardio, Neuro, Leminectomy
Atraumatic vena cava forceps, acc. to Calne

Material: Stainless steel

Other Sizes:
015-0425-00 : 27 cm

CARDIO, NEURO, LEMINECTOMY



Cardio, Neuro, Leminectomy
Atraumatic liver forceps, acc. to Pittsburgh

Material: Stainless steel

Other Sizes:

015-0425-01	25 cm
015-0425-02	26 cm
015-0425-03	27 cm



Cardio, Neuro, Leminectomy
Atraumatic forceps for kidney and pancreas

Material: Stainless steel

Other Sizes:

015-0425-07	40 mm, 20 cm
015-0425-08	50 mm, 20 cm
015-0425-09	60 mm, 20 cm



Cardio, Neuro, Leminectomy
Atraumatic vascular forceps, acc. to Satinsky

Material: Stainless steel

Other Sizes:

015-0425-15	15.5 cm
-------------	---------



Cardio, Neuro, Leminectomy
Atraumatic tangential forceps, acc. to Satinsky

Material: Stainless steel

Other Sizes:

015-0425-20	22 cm
015-0425-24	26 cm
015-0425-25	26.5 cm
015-0425-26	27.5 cm
015-0425-27	28.5 cm



Cardio, Neuro, Leminectomy
Auricle forceps, acc. to Harken, curved

Material: Stainless steel

Other Sizes:

015-0426-01	24.5 cm
-------------	---------



Cardio, Neuro, Leminectomy
Auricle forceps, acc. to Harken, strongly curved

Material: Stainless steel

Other Sizes:

015-0426-02	24 cm
-------------	-------

CARDIO, NEURO, LEMINECTOMY



Cardio, Neuro, Leminectomy
Auricle forceps, acc. to Harken,
double curved

Material: Stainless steel

Other Sizes:
015-0426-03 : 23 cm



Cardio, Neuro, Leminectomy
Auricle forceps, acc. to Harken, angled

Material: Stainless steel

Other Sizes:
015-0426-04 : 23.5 cm



Cardio, Neuro, Leminectomy
Atraumatic bronChus forceps, acc.
to Lees, angled

Material: Stainless steel

Other Sizes:
015-0427-23 : 23 cm



Cardio, Neuro, Leminectomy
Atraumatic bronChus forceps, acc.
to Lees, angled

Material: Stainless steel

Other Sizes:
015-0427-25 : 25.5 cm



Cardio, Neuro, Leminectomy
Atraumatic bronChus forceps, acc.
to Lees, curved/angled

Material: Stainless steel

Other Sizes:
015-0429-25 : 25 cm



Cardio, Neuro, Leminectomy
Atraumatic anastomosis forceps, acc.
to Glover

Material: Stainless steel

Other Sizes:
015-0430-00 : 18 cm
015-0430-01 : 22 cm



Cardio, Neuro, Leminectomy

Atraumatic anastomosis forceps, acc. to Lambert Kay

Material: Stainless steel

Other Sizes:

015-0430-21 : 22.5 cm

Cardio, Neuro, Leminectomy

Atraumatic anastomosis forceps, acc. to Lambert Kay

Material: Stainless steel

Other Sizes:

015-0430-22 : 22.5 cm



Cardio, Neuro, Leminectomy

Atraumatic anastomosis forceps, acc. to De Bakey

Material: Stainless steel

Other Sizes:

015-0431-17 : 16.5 cm



Cardio, Neuro, Leminectomy

Atraumatic aorta forceps, acc. to Morris, angled

Material: Stainless steel

Other Sizes:

015-0432-18 : 16.5 cm



Cardio, Neuro, Leminectomy

Atraumatic aorta forceps, acc. to Morris, angled

Material: Stainless steel

Other Sizes:

015-0432-20 : 20 cm



Cardio, Neuro, Leminectomy

Atraumatic aorta forceps, acc. to Morris, angled,

Material: Stainless steel

Other Sizes:

015-0432-23 : 24 cm

CARDIO, NEURO, LEMINECTOMY



Cardio, Neuro, Leminectomy
Atraumatic aorta forceps, acc.
to Morris, angled

Material: Stainless steel

Other Sizes:

015-0432-25 : 26 cm



Cardio, Neuro, Leminectomy
Atraumatic aorta forceps, acc.
to Bahnson, strongly curved

Material: Stainless steel

Other Sizes:

015-0433-23 : 23.5 cm



Cardio, Neuro, Leminectomy
Atraumatic aorta forceps, acc.
to Bahnson, curved

Material: Stainless steel

Other Sizes:

015-0433-24 : 24.5 cm



Cardio, Neuro, Leminectomy
Atraumatic aorta forceps, acc.
to Bahnson, curved

Material: Stainless steel

Other Sizes:

015-0433-25 : 25.5 cm
015-0433-27 : 26.5 cm



Cardio, Neuro, Leminectomy
Atraumatic forceps, acc. to Potts, straight

Material: Stainless steel

Other Sizes:

015-0434-21 : 21.5 cm
015-0434-23 : 23.5 cm
015-0434-27 : 27 cm
015-0434-31 : 31 cm



Cardio, Neuro, Leminectomy
Atraumatic forceps, acc. to Potts, curved

Material: Stainless steel

Other Sizes:

015-0435-21 : 21 cm
015-0435-23 : 23 cm
015-0435-27 : 27 cm
015-0435-31 : 30.5 cm



Cardio, Neuro, Leminectomy
Atraumatic forceps, acc. to De Bakey,
angled

Material: Stainless steel

Other Sizes:

015-0436-18	18 cm
015-0436-19	18.5 cm
015-0436-23	21.5 cm
015-0436-27	25.5 cm



Cardio, Neuro, Leminectomy
Atraumatic forceps, acc. to De Bakey,
angled

Material: Stainless steel

Other Sizes:

015-0437-20	21 cm
015-0437-21	22 cm
015-0437-25	26 cm
015-0437-29	31 cm
015-0437-18	18 cm



Cardio, Neuro, Leminectomy
Atraumatic forceps, acc. to Mosquito,
straight

Material: Stainless steel

Other Sizes:

015-0438-12	12.5 cm
-------------	---------



Cardio, Neuro, Leminectomy
Atraumatic forceps, acc. to Pean,
straight

Material: Stainless steel

Other Sizes:

015-0438-14	14.5 cm
015-0438-16	16.5 cm
015-0438-18	18.5 cm
015-0438-20	20.5 cm



Cardio, Neuro, Leminectomy
Atraumatic forceps, acc. to Mosquito,
curved

Material: Stainless steel

Other Sizes:

015-0439-12	12.5 cm
-------------	---------



Cardio, Neuro, Leminectomy
Atraumatic forceps, acc. to De Bakey,
curved

Material: Stainless steel

Other Sizes:

015-0439-14	14.5 cm
015-0439-16	16.5 cm
015-0439-18	18.5 cm
015-0439-20	20.5 cm



Cardio, Neuro, Leminectomy
Atraumatic forceps, acc. to De Bakey,
straight

Material: Stainless steel

Other Sizes:
015-0440-17 : 17 cm



Cardio, Neuro, Leminectomy
Atraumatic forceps, acc. to De Bakey,
angled

Material: Stainless steel

Other Sizes:
015-0441-16 : 16.5 cm



Cardio, Neuro, Leminectomy
Atraumatic forceps, acc. to De Bakey,
medium angled

Material: Stainless steel

Other Sizes:
015-0443-15 : 16 cm



Cardio, Neuro, Leminectomy
Atraumatic forceps, acc. to De Bakey,
strongly angled

Material: Stainless steel

Other Sizes:
015-0445-15 : 14.5 cm



Cardio, Neuro, Leminectomy
Atraumatic forceps, acc. to De Bakey,
angled

Material: Stainless steel

Other Sizes:
015-0447-17 : 16.5 cm



Cardio, Neuro, Leminectomy
Atraumatic forceps, acc. to Glover,
curved

Material: Stainless steel

Other Sizes:
015-0449-17 : 17 cm



Cardio, Neuro, Leminectomy
Atraumatic forceps, acc. to Glover,
spoon-shape

Material: Stainless steel

Other Sizes:

015-0451-17	17.5 cm
015-0451-21	21 cm
015-0451-26	26 cm



Cardio, Neuro, Leminectomy
Atraumatic forceps, acc. to De Bakey,
straight curved

Material: Stainless steel

Other Sizes:

015-0453-16	16.5 cm
-------------	---------



Cardio, Neuro, Leminectomy
Anastomosis forceps, acc. to De
Bakey-Reynolds

Material: Stainless steel

Other Sizes:

015-0454-16	16.5 cm
-------------	---------



Cardio, Neuro, Leminectomy
Anastomosis forceps, acc. to De
Bakey-Reynolds

Material: Stainless steel

Other Sizes:

015-0454-17	17.5 cm
-------------	---------



Cardio, Neuro, Leminectomy
Atraumatic forceps, acc. to De
Bakey, straight curved

Material: Stainless steel

Other Sizes:

015-0455-17	17 cm
-------------	-------



Cardio, Neuro, Leminectomy
Anastomosis forceps, acc. to Derra

Material: Stainless steel

Other Sizes:

015-0456-16	16.5 cm
015-0456-17	17 cm
015-0456-18	18 cm



Cardio, Neuro, Leminectomy
Atraumatic forceps, acc. to Beck,
double curved

Material: Stainless steel

Other Sizes:

015-0457-17	17 cm
015-0457-19	19 cm
015-0457-21	21 cm



Cardio, Neuro, Leminectomy
Atraumatic forceps, acc. to De
Bakey, 90° angled

Material: Stainless steel

Other Sizes:

015-0458-10	10 cm
-------------	-------



Cardio, Neuro, Leminectomy
Atraumatic forceps, acc. to De
Bakey, curved

Material: Stainless steel

Other Sizes:

015-0458-11	12.5 cm
-------------	---------



Cardio, Neuro, Leminectomy
Atraumatic forceps, acc. to De
Bakey, straight

Material: Stainless steel

Other Sizes:

015-0458-12	13 cm
-------------	-------



Cardio, Neuro, Leminectomy
Atraumatic forceps, acc. to De
Bakey, s-shape

Material: Stainless steel

Other Sizes:

015-0459-12	12.5 cm
-------------	---------



Cardio, Neuro, Leminectomy
Atraumatic forceps, acc. to De
Bakey, angled

Material: Stainless steel

Other Sizes:

015-0459-13	12.5 cm
-------------	---------



Cardio, Neuro, Leminectomy
Ti forceps, neonatal, straight

Material: Stainless steel

Other Sizes:
015-0460-01 : 13 cm



Cardio, Neuro, Leminectomy
Ti forceps, neonatal

Material: Stainless steel

Other Sizes:
015-0460-02 : 30°, 12.5 cm
015-0460-03 : 50°, 12.5 cm
015-0460-04 : 70°, 12 cm
015-0460-05 : 90°, 11 cm



Cardio, Neuro, Leminectomy
Ti forceps, neonatal, strongly curved

Material: Stainless steel

Other Sizes:
015-0460-06 : 15 cm
015-0460-07 : 15 cm



Cardio, Neuro, Leminectomy
Ti forceps, neonatal, strongly curved

Material: Stainless steel

Other Sizes:
015-0460-08 : 12 cm



Cardio, Neuro, Leminectomy
Ti forceps, neonatal, double angled

Material: Stainless steel

Other Sizes:
015-0460-09 : 15 cm



Cardio, Neuro, Leminectomy
Ti forceps, neonatal, double angled

Material: Stainless steel

Other Sizes:
015-0460-10 : 15 cm



Cardio, Neuro, Leminectomy
Ti forceps, neonatal, double angled

Material: Stainless steel

Other Sizes:
015-0460-11 : 15 cm



Cardio, Neuro, Leminectomy
Ti forceps, pediatric, straight

Material: Stainless steel

Other Sizes:
015-0461-01 : 13.5 cm



Cardio, Neuro, Leminectomy
Ti forceps, pediatric

Material: Stainless steel

Other Sizes:
015-0461-02 : 20°, 13.5 cm
015-0461-03 : 30°, 13 cm
015-0461-04 : 55°, 12.5 cm



Cardio, Neuro, Leminectomy
Ti forceps, pediatric, curved

Material: Stainless steel

Other Sizes:
015-0461-05 : 13.5 cm



Cardio, Neuro, Leminectomy
Ti forceps, pediatric, double angled

Material: Stainless steel

Other Sizes:
015-0461-06 : 12 cm
015-0461-07 : 12 cm



Cardio, Neuro, Leminectomy
Ti forceps, pediatric, strongly curved

Material: Stainless steel

Other Sizes:
015-0461-08 : 12.5 cm



Cardio, Neuro, Leminectomy
Ti forceps, pediatric, strongly curved

Material: Stainless steel

Other Sizes:
015-0461-09 : 13 cm



Cardio, Neuro, Leminectomy
Ti forceps, pediatric, angled, left/right

Material: Stainless steel

Other Sizes:
015-0461-10 : 14 cm
015-0461-11 : 14 cm



Cardio, Neuro, Leminectomy
Ti forceps, acc. to Cooley, straight

Material: Stainless steel

Other Sizes:
015-0461-30 : 14 cm



Cardio, Neuro, Leminectomy
Ti forceps, acc. to Cooley, angled

Material: Stainless steel

Other Sizes:
015-0461-31 : 14 cm



Cardio, Neuro, Leminectomy
Ti forceps, acc. to Cooley, angled

Material: Stainless steel

Other Sizes:
015-0461-32 : 14 cm



Cardio, Neuro, Leminectomy
Ti forceps, acc. to Cooley, spoon shape

Material: Stainless steel

Other Sizes:
015-0461-33 : 13.5 cm



Cardio, Neuro, Leminectomy
Ti forceps, acc. to Cooley, double curved

Material: Stainless steel

Other Sizes:

015-0461-34 : 13.5 cm



Cardio, Neuro, Leminectomy
Ti forceps, acc. to Cooley

Material: Stainless steel

Other Sizes:

015-0461-35 : 90°, 11.5 cm

015-0461-36 : 90°, 11.5 cm

015-0461-37 : 90°, 11.5 cm



Cardio, Neuro, Leminectomy
Ti forceps, pediatric, straight

Material: Stainless steel

Other Sizes:

015-0461-50 : 16.5 cm



Cardio, Neuro, Leminectomy
Ti forceps, pediatric, angled

Material: Stainless steel

Other Sizes:

015-0461-51 : 16 cm

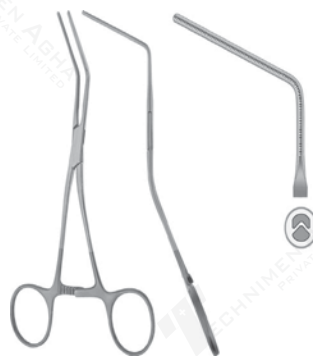

Cardio, Neuro, Leminectomy
Ti forceps, pediatric, angled

Material: Stainless steel

Other Sizes:

015-0461-52 : 15 cm



Cardio, Neuro, Leminectomy
Ti forceps, pediatric, double curved

Material: Stainless steel

Other Sizes:

015-0461-53 : 15 cm

015-0461-54 : 15 cm



Cardio, Neuro, Leminectomy
Ti forceps, acc. to De Bakey, straight

Material: Stainless steel

Other Sizes:
015-0462-01 13 cm



Cardio, Neuro, Leminectomy
Ti forceps, acc. to De Bakey, curved

Material: Stainless steel

Other Sizes:
015-0462-02 12.5 cm



Cardio, Neuro, Leminectomy
Ti forceps, acc. to De Bakey, angled

Material: Stainless steel

Other Sizes:
015-0462-03 10 cm



Cardio, Neuro, Leminectomy
Ti forceps, acc. to De Bakey, curved

Material: Stainless steel

Other Sizes:
015-0462-04 12.5 cm



Cardio, Neuro, Leminectomy
Ti forceps, acc. to De Bakey, angled

Material: Stainless steel

Other Sizes:
015-0462-05 12.5 cm



Cardio, Neuro, Leminectomy
Ti forceps, submanian, left

Material: Stainless steel

Other Sizes:
015-0462-20 15.5 cm



Cardio, Neuro, Leminectomy
Ti forceps, subramanian, right

Material: Stainless steel

Other Sizes:
015-0462-21 : 15.5 cm



Cardio, Neuro, Leminectomy
Ti forceps, subramanian

Material: Stainless steel

Other Sizes:
015-0462-22 : 135°, 16.5 cm



Cardio, Neuro, Leminectomy
Ti forceps, acc. to Beck, double curved

Material: Stainless steel

Other Sizes:
015-0462-23 : 16 cm



Cardio, Neuro, Leminectomy
Ti forceps, acc. to De Bakey-Derra

Material: Stainless steel

Other Sizes:
015-0462-40 : 16.5 cm
015-0462-41 : 16.5 cm
015-0462-42 : 16.5 cm



Cardio, Neuro, Leminectomy
Ti forceps, acc. to De Bakey-Satinsky

Material: Stainless steel

Other Sizes:
015-0462-43 : 23.5 cm
015-0462-44 : 24 cm
015-0462-45 : 24.5 cm
015-0462-46 : 25 cm
015-0462-47 : 28.5 cm



Cardio, Neuro, Leminectomy
Ti forceps, acc. to Lambert-Kay

Material: Stainless steel

Other Sizes:
015-0462-48 : 19.5 cm

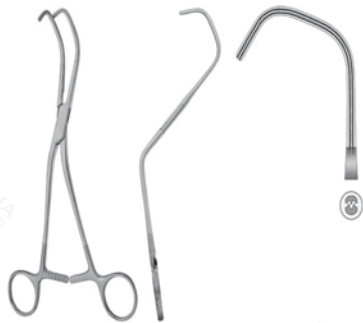

Cardio, Neuro, Leminectomy
Ti aortic forceps, acc. to De Bakey

Material: Stainless steel

Other Sizes:

015-0462-60	26 cm
015-0462-61	26.5 cm
015-0462-62	31 cm
015-0462-63	33 cm



Cardio, Neuro, Leminectomy
Atraumatic forceps, acc. to Cooley,
2.0 mm

Material: Stainless steel

Other Sizes:

015-0464-16	16 cm
015-0464-20	20 cm

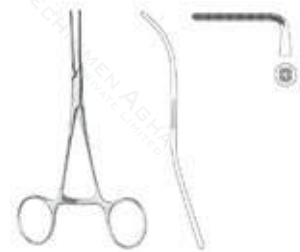

Cardio, Neuro, Leminectomy
Atraumatic forceps, acc. to Cooley

Material: Stainless steel

Other Sizes:

015-0466-00	90°, 11.5 cm
-------------	--------------



Cardio, Neuro, Leminectomy
Atraumatic forceps, acc. to Cooley,
straight

Material: Stainless steel

Other Sizes:

015-0466-01	14.5 cm
-------------	---------



Cardio, Neuro, Leminectomy
Atraumatic forceps, acc. to Cooley,
angled

Material: Stainless steel

Other Sizes:

015-0466-02	14.5 cm
-------------	---------



Cardio, Neuro, Leminectomy
Atraumatic forceps, acc. to Cooley,
angled

Material: Stainless steel

Other Sizes:

015-0466-03	14 cm
-------------	-------

CARDIO, NEURO, LEMINECTOMY



Cardio, Neuro, Leminectomy
Atraumatic forceps, acc. to Cooley,
double curved

Material: Stainless steel

Other Sizes:

015-0466-04 : 14 cm



Cardio, Neuro, Leminectomy
Atraumatic forceps, acc. to Cooley,
spoon shape

Material: Stainless steel

Other Sizes:

015-0466-05 : 14.5 cm



Cardio, Neuro, Leminectomy
Atraumatic forceps, acc. to Cooley,
curved

Material: Stainless steel

Other Sizes:

015-0466-06 : 12.5 cm



Cardio, Neuro, Leminectomy
Atraumatic iliaca forceps, acc. to
Cooley, angled

Material: Stainless steel

Other Sizes:

015-0467-21 : 22 cm



Cardio, Neuro, Leminectomy
Atraumatic forceps, acc. to
Cooley, straight

Material: Stainless steel

Other Sizes:

015-0468-17 : 17 cm



Cardio, Neuro, Leminectomy
Atraumatic vascular forceps, acc. to
Cooley-Parry

Material: Stainless steel

Other Sizes:

015-0469-18 : 18 cm
015-0469-26 : 26 cm

CARDIO, NEURO, LEMINECTOMY

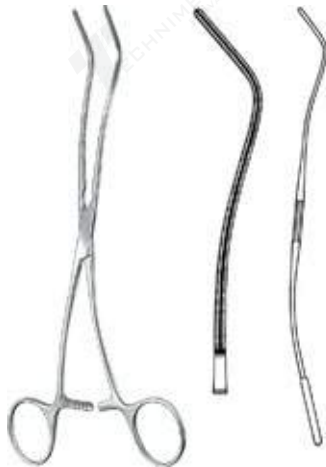

Cardio, Neuro, Leminectomy
Atraumatic carotis forceps, acc. to Cooley, angled

Material: Stainless steel

Other Sizes:
015-0469-20 : 20 cm



Cardio, Neuro, Leminectomy
Atraumatic forceps, acc. to Cooley, curved sideways

Material: Stainless steel

Other Sizes:
015-0470-17 : 17 cm



Cardio, Neuro, Leminectomy
Atraumatic forceps, acc. to Cooley, double curved

Material: Stainless steel

Other Sizes:
015-0471-16 : 16 cm



Cardio, Neuro, Leminectomy
Atraumatic forceps, acc. to Cooley, straight angled

Material: Stainless steel

Other Sizes:
015-0472-15 : 14 cm



Cardio, Neuro, Leminectomy
Atraumatic forceps, acc. to Cooley, medium angled

Material: Stainless steel

Other Sizes:
015-0472-16 : 16 cm



Cardio, Neuro, Leminectomy
Atraumatic forceps, acc. to Cooley, slight angled

Material: Stainless steel

Other Sizes:
015-0472-17 : 16.5 cm

CARDIO, NEURO, LEMINECTOMY



Cardio, Neuro, Leminectomy
Atraumatic forceps, acc. to Cooley, angled

Material: Stainless steel

Other Sizes:
015-0473-17 : 17 cm



Cardio, Neuro, Leminectomy
Atraumatic forceps, acc. to Cooley, curved

Material: Stainless steel

Other Sizes:
015-0474-17 : 17 cm



Cardio, Neuro, Leminectomy
Atraumatic vascular forceps, acc. to Cooley

Material: Stainless steel

Other Sizes:
015-0475-26 : 26.5 cm
015-0475-27 : 26.5 cm
015-0475-28 : 27.5 cm



Cardio, Neuro, Leminectomy
Atraumatic forceps, acc. to Cooley, spoon-shape

Material: Stainless steel

Other Sizes:
015-0476-17 : 17.5 cm



Cardio, Neuro, Leminectomy
Atraumatic forceps, acc. to Cooley, straight curved

Material: Stainless steel

Other Sizes:
015-0477-16 : 16.5 cm
015-0477-17 : 17 cm



Cardio, Neuro, Leminectomy
Anastomosis forceps, acc. to Cooley-Derra

Material: Stainless steel

Other Sizes:
015-0478-16 : 16.5 cm
015-0478-17 : 17 cm
015-0478-18 : 17.5 cm
015-0478-21 : 21 cm



Cardio, Neuro, Leminectomy
Atraumatic forceps, acc. to Cooley-Beck, angled

Material: Stainless steel

Other Sizes:
015-0479-17 : 17 cm



Cardio, Neuro, Leminectomy
Atraumatic vascular forceps, acc. to acc. to Allenberg-Cobra

Material: Stainless steel

Other Sizes:
015-0480-23 : 23.5 cm
015-0480-25 : 26.5 cm



Cardio, Neuro, Leminectomy
Aorta-Dilator, acc. to Tubbs

Material: Stainless steel

Other Sizes:
015-0482-00 : 8-42 mm



Cardio, Neuro, Leminectomy
Vascular dilator, acc. to De Bakey

Material: steel 18/8 martinit, antimagnetic, stainless, acid-resistant

Other Sizes:
015-0492-05 : Ø 0.5 mm, 19 cm
015-0492-10 : Ø 1.0 mm, 19 cm
015-0492-15 : Ø 1.5 mm, 19 cm
015-0492-20 : Ø 2.0 mm, 19 cm



Cardio, Neuro, Leminectomy
Vascular dilator, acc. to De Bakey

Material: steel 18/8 martinit, antimagnetic, stainless, acid-resistant

Other Sizes:
015-0492-25 : Ø 2.5 mm, 19 cm
015-0492-30 : Ø 3.0 mm, 19 cm
015-0492-35 : Ø 3.5 mm, 19 cm
015-0492-40 : Ø 4.0 mm, 19 cm



Cardio, Neuro, Leminectomy
Vascular dilator, acc. to De Bakey

Material: steel 18/8 martinit, antimagnetic, stainless, acid-resistant

Other Sizes:
015-0492-45 : Ø 4.5 mm, 19 cm
015-0492-50 : Ø 5.0 mm, 19 cm
015-0492-70 : Ø 7.0 mm, 19 cm
015-0492-90 : Ø 9.0 mm, 19 cm

CARDIO, NEURO, LEMINECTOMY



Cardio, Neuro, Leminectomy
Dilator, acc. to De Bakey

Material: steel 18/8 martinit,
antimagnetic, stainless, acid-resistant

Other Sizes:

015-0493-05	∅ 0.5 mm, 14 cm
015-0493-10	∅ 1.0 mm, 14 cm
015-0493-15	∅ 1.5 mm, 14 cm
015-0493-20	∅ 2.0 mm, 14 cm



Cardio, Neuro, Leminectomy
Dilator, acc. to De Bakey

Material: steel 18/8 martinit,
antimagnetic, stainless, acid-resistant

Other Sizes:

015-0493-25	∅ 2.5 mm, 14 cm
015-0493-30	∅ 3.0 mm, 14 cm
015-0493-35	∅ 3.5 mm, 14 cm
015-0493-40	∅ 4.0 mm, 14 cm



Cardio, Neuro, Leminectomy
Dilator, acc. to De Bakey

Material: steel 18/8 martinit,
antimagnetic, stainless, acid-resistant

Other Sizes:

015-0493-45	∅ 4.5 mm, 14 cm
015-0493-50	∅ 5.0 mm, 14 cm



Cardio, Neuro, Leminectomy
Tunneler set, acc. to Martin, complete

Material: steel 18/8 martinit,
antimagnetic, stainless, acid-resistant

Other Sizes:

015-0502-00	N/A
-------------	-----



Cardio, Neuro, Leminectomy
Tunneler Handle, for 015-0502-00 (2 pieces)

Material: steel 18/8 martinit,
antimagnetic, stainless, acid-resistant

Other Sizes:

015-0502-01	12.5 cm
-------------	---------



Cardio, Neuro, Leminectomy
Tunneler shaft, curved

Material: steel 18/8 martinit,
antimagnetic, stainless, acid-resistant

Other Sizes:

015-0502-05	24.5 cm
-------------	---------

CARDIO, NEURO, LEMINECTOMY



Cardio, Neuro, Leminectomy
Tunneler shaft, straight

Material: steel 18/8 martinit,
antimagnetic, stainless, acid-resistant

Other Sizes:
015-0502-06 : 24.5 cm



Cardio, Neuro, Leminectomy
Tunneler shaft, curved

Material: steel 18/8 martinit,
antimagnetic, stainless, acid-resistant

Other Sizes:
015-0502-11 : 55.5 cm



Cardio, Neuro, Leminectomy
Olive tip, for 015-0502-00

Material: steel 18/8 martinit,
antimagnetic, stainless, acid-resistant

Other Sizes:
015-0502-55 : Ø 5 mm
015-0502-56 : Ø 6 mm
015-0502-57 : Ø 7 mm
015-0502-58 : Ø 8 mm
015-0502-60 : Ø 10 mm
015-0502-62 : Ø 12 mm



Cardio, Neuro, Leminectomy
Vein tip, Luer Lock, for 015-0502-00

Material: steel 18/8 martinit,
antimagnetic, stainless, acid-resistant

Other Sizes:
015-0502-65 : N/A



Cardio, Neuro, Leminectomy
Luer adapter, Luer Lock, for 015-0502-00

Material: steel 18/8 martinit,
antimagnetic, stainless, acid-resistant

Other Sizes:
015-0502-70 : N/A



Cardio, Neuro, Leminectomy
WrenCh, for 015-0502-00

Material: Stainless steel

Other Sizes:
015-0502-99 : 10 cm

CARDIO, NEURO, LEMINECTOMY



Cardio, Neuro, Leminectomy
Dilator, acc. to Cooley

Material: steel 18/8 martinit,
antimagnetic, stainless, acid-resistant

Other Sizes:

015-0506-05	Ø 0.5 mm, 14 cm
015-0506-10	Ø 1.0 mm, 14 cm
015-0506-15	Ø 1.5 mm, 14 cm



Cardio, Neuro, Leminectomy
Dilator, acc. to Cooley

Material: steel 18/8 martinit,
antimagnetic, stainless, acid-resistant

Other Sizes:

015-0506-20	Ø 2.0 mm, 14 cm
015-0506-25	Ø 2.5 mm, 14 cm
015-0506-30	Ø 3.0 mm, 14 cm



Cardio, Neuro, Leminectomy
Dilator, acc. to Cooley

Material: steel 18/8 martinit,
antimagnetic, stainless, acid-resistant

Other Sizes:

015-0507-05	Ø 0.5 mm, 19 cm
015-0507-10	Ø 1.0 mm, 19 cm
015-0507-15	Ø 1.5 mm, 19 cm



Cardio, Neuro, Leminectomy
Dilator, acc. to Cooley

Material: steel 18/8 martinit,
antimagnetic, stainless, acid-resistant

Other Sizes:

015-0507-20	Ø 2.0 mm, 19 cm
015-0507-25	Ø 2.5 mm, 19 cm
015-0507-30	Ø 3.0 mm, 19 cm



Cardio, Neuro, Leminectomy
Dilator, acc. to De Bakey, Nitinol

Material: all other, not
specially marked material types

Other Sizes:

015-0509-05	Ø 0.5 mm, 14 cm
015-0509-10	Ø 1.0 mm, 14 cm
015-0509-15	Ø 1.5 mm, 14 cm
015-0509-20	Ø 2.0 mm, 14 cm



Cardio, Neuro, Leminectomy
Dilator, acc. to De Bakey, Nitinol

Material: all other, not
specially marked material types

Other Sizes:

015-0509-25	Ø 2.5 mm, 14 cm
015-0509-30	Ø 3.0 mm, 14 cm
015-0509-35	Ø 3.5 mm, 14 cm
015-0509-40	Ø 4.0 mm, 14 cm



Cardio, Neuro, Leminectomy
Dilator, acc. to De Bakey, Nitinol

Material: all other, not specially marked material types

Other Sizes:

015-0509-45	∅ 4.5 mm, 14 cm
015-0509-50	∅ 5.0 mm, 14 cm



Cardio, Neuro, Leminectomy
Dilator, acc. to De Bakey, Nitinol

Material: all other, not specially marked material types

Other Sizes:

015-0510-25	∅ 2.5 mm, 19 cm
015-0510-30	∅ 3.0 mm, 19 cm
015-0510-35	∅ 3.5 mm, 19 cm
015-0510-40	∅ 4.0 mm, 19 cm



Cardio, Neuro, Leminectomy
Dilator, acc. to De Bakey, Nitinol

Material: all other, not specially marked material types

Other Sizes:

015-0510-45	∅ 4.5 mm, 19 cm
015-0510-50	∅ 5.0 mm, 19 cm
015-0510-70	∅ 7.0 mm, 19 cm
015-0510-90	∅ 9.0 mm, 19 cm



Cardio, Neuro, Leminectomy
Dilator, acc. to Cooley, Nitinol

Material: all other, not specially marked material types

Other Sizes:

015-0515-05	∅ 0.5 mm, 14 cm
015-0515-10	∅ 1.0 mm, 14 cm
015-0515-15	∅ 1.5 mm, 14 cm



Cardio, Neuro, Leminectomy
Dilator, acc. to Cooley, Nitinol

Material: all other, not specially marked material types

Other Sizes:

015-0515-20	∅ 2.0 mm, 14 cm
015-0515-25	∅ 2.5 mm, 14 cm
015-0515-30	∅ 3.0 mm, 14 cm



Cardio, Neuro, Leminectomy
Dilator, acc. to Cooley, Nitinol

Material: all other, not specially marked material types

Other Sizes:

015-0516-05	∅ 0.5 mm, 19 cm
015-0516-10	∅ 1.0 mm, 19 cm
015-0516-15	∅ 1.5 mm, 19 cm

CARDIO, NEURO, LEMINECTOMY



Cardio, Neuro, Leminectomy
Dilator, acc. to Cooley, Nitinol

Material: all other, not specially marked material types

Other Sizes:

015-0516-20	∅ 2.0 mm, 19 cm
015-0516-25	∅ 2.5 mm, 19 cm
015-0516-30	∅ 3.0 mm, 19 cm



Cardio, Neuro, Leminectomy
Fasciotomy spatula, acc. to HaCh

Material: Stainless steel

Other Sizes:

015-0526-25	25 mm, 30 cm
015-0526-32	32 mm, 30 cm



Cardio, Neuro, Leminectomy
Fasciotomy spatula, acc. to HaCh

Material: Stainless steel

Other Sizes:

015-0526-40	40 mm, 30 cm
015-0526-52	52 mm, 30 cm



Cardio, Neuro, Leminectomy
Intima spatula, blunt, 3 mm

Material: Stainless steel

Other Sizes:

015-0535-18	18.5 cm
015-0535-21	21.5 cm



Cardio, Neuro, Leminectomy
Intima spatula, slim, blunt

Material: Stainless steel

Other Sizes:

015-0537-14	14 cm
-------------	-------



Cardio, Neuro, Leminectomy
Intima spatula, wide, blunt

Material: Stainless steel

Other Sizes:

015-0537-24	23.5 cm
-------------	---------

CARDIO, NEURO, LEMINECTOMY



Cardio, Neuro, Leminectomy

Dissector, acc. to Robb, double-ended,
no. 1

Material: Stainless steel

Other Sizes:

015-0539-01 : 24 cm



Cardio, Neuro, Leminectomy

Dissector, acc. to Robb, double-ended,
no. 2

Material: Stainless steel

Other Sizes:

015-0539-02 : 24 cm



Cardio, Neuro, Leminectomy

Dissector, acc. to Robb, double-ended,
no. 3

Material: Stainless steel

Other Sizes:

015-0539-03 : 24 cm



Cardio, Neuro, Leminectomy

Dissector, acc. to Robb, double-ended,
no. 4

Material: Stainless steel

Other Sizes:

015-0539-04 : 24 cm



Cardio, Neuro, Leminectomy

Nerve hook, acc. to Crile

Material: Stainless steel

Other Sizes:

015-0541-20 : 90°, 20 cm



Cardio, Neuro, Leminectomy

Nerve hook, acc. to Crile

Material: Stainless steel

Other Sizes:

015-0543-20 : 45°, 20.5 cm

CARDIO, NEURO, LEMINECTOMY



Cardio, Neuro, Leminectomy
Suture hook

Material: Stainless steel

Other Sizes:

015-0550-15	∅ 1.5 mm, 26 cm
015-0550-20	∅ 2.0 mm, 26 cm
015-0550-25	∅ 2.5 mm, 26 cm
015-0550-30	∅ 3.0 mm, 26 cm



Cardio, Neuro, Leminectomy
Tourniquet, acc. to Rumel-Belmont

Material: Stainless steel

Other Sizes:

015-0556-33	4.2 mm, 27 cm
015-0558-33	8.8 mm, 30.5 cm



Cardio, Neuro, Leminectomy
Atraumatic forceps, acc. to Subramanian
Miniature

Material: Stainless steel

Other Sizes:

015-0559-15	135°, 16 cm
-------------	-------------



Cardio, Neuro, Leminectomy
Atraumatic forceps, acc. to Subramanian,
right/left

Material: Stainless steel

Other Sizes:

015-0561-16	16 cm
-------------	-------



Cardio, Neuro, Leminectomy
Atraumatic forceps, "De Bakey Baby",
pediatric, straight, no. 1

Material: Stainless steel

Other Sizes:

015-0573-01	13.5 cm
-------------	---------



Cardio, Neuro, Leminectomy
Atraumatic forceps, "De Bakey Baby",
pediatric, 20°, no. 2

Material: Stainless steel

Other Sizes:

015-0573-02	13.5 cm
-------------	---------



Cardio, Neuro, Leminectomy
Atraumatic forceps, "De Bakey Baby",
pediatric, 30°, no. 3

Material: Stainless steel

Other Sizes:
015-0573-03 : 14 cm



Cardio, Neuro, Leminectomy
Atraumatic forceps, "De Bakey Baby",
pediatric, 55°, no. 4

Material: Stainless steel

Other Sizes:
015-0573-04 : 13.5 cm



Cardio, Neuro, Leminectomy
Atraumatic forceps, "De Bakey Baby",
pediatric, curved, no. 5

Material: Stainless steel

Other Sizes:
015-0573-05 : 13.5 cm



Cardio, Neuro, Leminectomy
Atraumatic forceps, "De Bakey Baby",
pediatric, angled

Material: Stainless steel

Other Sizes:
015-0573-06 : 12.5 cm



Cardio, Neuro, Leminectomy
Atraumatic forceps, "De Bakey Baby",
pediatric, angled

Material: Stainless steel

Other Sizes:
015-0573-07 : 13 cm

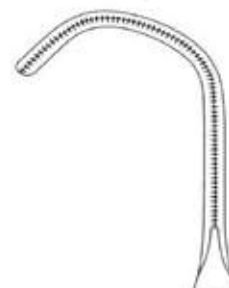

Cardio, Neuro, Leminectomy
Atraumatic forceps, "De Bakey Baby",
pediatric, strongly curved

Material: Stainless steel

Other Sizes:
015-0573-08 : 13.5 cm

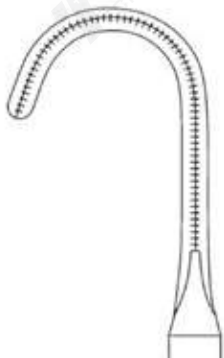

Cardio, Neuro, Leminectomy
Atraumatic forceps, "De Bakey Baby",
pediatric, strongly curved

Material: Stainless steel

Other Sizes:
015-0573-09 : 13 cm



Cardio, Neuro, Leminectomy
Ti forceps, neonatal,

Material: Stainless steel

Other Sizes:
015-0581-01 : 10.5 cm



Cardio, Neuro, Leminectomy
Ti forceps, neonatal, angled 60°

Material: Stainless steel

Other Sizes:
015-0581-02 : 10.5 cm



Cardio, Neuro, Leminectomy
Ti forceps, neonatal, spoon-shape

Material: Stainless steel

Other Sizes:
015-0581-03 : 10.5 cm



Cardio, Neuro, Leminectomy
Ti forceps, neonatal, anast., 10,5 cm

Material: Stainless steel

Other Sizes:
015-0581-04 : 10.5 cm
015-0581-05 : 10.5 cm



Cardio, Neuro, Leminectomy
Atraumatic forceps, pediatric, straight

Material: Stainless steel

Other Sizes:
015-0588-16 : 16



Cardio, Neuro, Leminectomy
Atraumatic forceps, pediatric, angled

Material: Stainless steel

Other Sizes:

015-0589-16 : 16 cm



Cardio, Neuro, Leminectomy
Atraumatic forceps, pediatric, medium angled

Material: Stainless steel

Other Sizes:

015-0590-16 : 15.5 cm



Cardio, Neuro, Leminectomy
Atraumatic forceps, PEDI., double-ended curved

Material: Stainless steel

Other Sizes:

015-0591-15 : 15.5 cm



Cardio, Neuro, Leminectomy
Atraumatic forceps, PEDI., double-ended curved

Material: Stainless steel

Other Sizes:

015-0592-16 : 16 cm



Cardio, Neuro, Leminectomy
Atraumatic neonatal forceps, straight

Material: Stainless steel

Other Sizes:

015-0593-00 : 13 cm
015-0593-01 : 12.5 cm
015-0593-02 : 12 cm
015-0593-03 : 11 cm



Cardio, Neuro, Leminectomy
Atraumatic neonatal forceps, curved

Material: Stainless steel

Other Sizes:

015-0595-01 : 12 cm
015-0595-02 : 12 cm
015-0595-03 : 12 cm
015-0595-04 : 12 cm



Cardio, Neuro, Leminectomy
Wire saw, acc. to Gigli, fourfold

Material: Stainless steel

Other Sizes:
015-0600-30 : 30 cm



Cardio, Neuro, Leminectomy
Hook Handle, for wire saws

Material: Stainless steel

Other Sizes:
015-0602-01 : N/A



Cardio, Neuro, Leminectomy
Wire saw conductor, acc. to De Martel

Material: Stainless steel

Other Sizes:
015-0618-33 : 33 cm



Cardio, Neuro, Leminectomy
Skull traction tong, acc. to CrutChfield, small

Material: Stainless steel

Other Sizes:
015-0641-01 : N/A



Cardio, Neuro, Leminectomy
Skull traction tong, acc. to CrutChfield, medium

Material: Stainless steel

Other Sizes:
015-0641-02 : N/A



Cardio, Neuro, Leminectomy
Drill pin, for 015-0641-02

Material: Stainless steel

Other Sizes:
015-0641-04 : Ø 4 mm, 7 cm
015-0641-05 : Ø 5 mm, 7 cm



Cardio, Neuro, Leminectomy
Skull traction tong, pins adjustable

Material: Stainless steel

Other Sizes:
015-0643-01 : N/A



Cardio, Neuro, Leminectomy
Cranial rongeur, acc. to Dahlgreen

Material: Stainless steel

Other Sizes:
015-0654-20 : 19.5 cm



Cardio, Neuro, Leminectomy
Cranial rongeur, acc. to De Vibbiss

Material: Stainless steel

Other Sizes:
015-0658-21 : 21 cm



Cardio, Neuro, Leminectomy
Cranial punCh, acc. to Cone

Material: Stainless steel

Other Sizes:
015-0659-22 : 22.5 cm



Cardio, Neuro, Leminectomy
Clip application forceps, acc. to Olivecrona-Toennis

Material: Stainless steel

Other Sizes:
015-0661-14 : N/A



Cardio, Neuro, Leminectomy
Clip application forceps, acc. to McKenzie, curved

Material: Stainless steel

Other Sizes:
015-0663-19 : 18.5 cm



Cardio, Neuro, Leminectomy
Suture clip, "Koeln type, 50 pieces

Material: Stainless steel

Other Sizes:
015-0674-00 : 50 pieces



Cardio, Neuro, Leminectomy
Scalp clamp, acc. to Raney

Material: Stainless steel

Other Sizes:
015-0675-00 : N/A



Cardio, Neuro, Leminectomy
Applying/removal forceps, for Raney clips

Material: Stainless steel

Other Sizes:
015-0676-00 : N/A



Cardio, Neuro, Leminectomy
Galea retractor (Hook), acc. to Yasargil

Material: Stainless steel

Other Sizes:
015-0678-01 : 30 cm
015-0678-02 : 41 cm



Cardio, Neuro, Leminectomy
Dura dissector, acc. to Toennis,
double-ended

Material: Stainless steel

Other Sizes:
015-0680-25 : 24 cm



Cardio, Neuro, Leminectomy
DURA-DISSECTOR, OLIVECRONA,
double-ended

Material: Stainless steel

Other Sizes:
015-0681-24 : 24 cm



Cardio, Neuro, Leminectomy
DURA-DISSECTOR, OLIVECRONA,
double-ended

Material: Stainless steel

Other Sizes:
015-0682-18 : 18 cm



Cardio, Neuro, Leminectomy
DURA-DISSECTOR, OLIVECRONA,
double-ended

Material: Stainless steel

Other Sizes:
015-0683-24 : 24 cm



Cardio, Neuro, Leminectomy
DURA-DISSECTOR, OLIVECRONA,
double-ended

Material: Stainless steel

Other Sizes:
015-0684-19 : 20 cm



Cardio, Neuro, Leminectomy
Nerve separator, acc. to SaChs, sharp

Material: Stainless steel

Other Sizes:
015-0685-21 : 20.5 cm



Cardio, Neuro, Leminectomy
NERVE SEPARATOR, MILLIGAN,
double-ended

Material: Stainless steel

Other Sizes:
015-0686-21 : 21.5 cm



Cardio, Neuro, Leminectomy
Nerve separator, acc. to Davies,
semi-sharp

Material: Stainless steel

Other Sizes:
015-0687-21 : 21.5 cm



Cardio, Neuro, Leminectomy
Dura dissector, double-ended

Material: Stainless steel

Other Sizes:
015-0688-22 : 22 cm



Cardio, Neuro, Leminectomy
Dura dissector, acc. to Penfield

Material: Stainless steel

Other Sizes:
015-0690-01 : 17.5 cm



Cardio, Neuro, Leminectomy
Dura dissector, acc. to Penfield

Material: Stainless steel

Other Sizes:
015-0690-02 : 19.5 cm
015-0690-03 : 19.5 cm



Cardio, Neuro, Leminectomy
Dura dissector, acc. to Penfield

Material: Stainless steel

Other Sizes:
015-0690-04 : 20.5 cm



Cardio, Neuro, Leminectomy
Dura dissector, acc. to Penfield

Material: Stainless steel

Other Sizes:
015-0690-05 : 18.5 cm



Cardio, Neuro, Leminectomy
DURA DISSECTOR, DAVIS,
double-ended

Material: Stainless steel

Other Sizes:
015-0691-24 : 24.5 cm

CARDIO, NEURO, LEMINECTOMY



Cardio, Neuro, Leminectomy
Spatula holder, acc. to Leyla, 1 arm,
complete

Material: Stainless steel

Other Sizes:
015-0702-01 : N/A



Cardio, Neuro, Leminectomy
Spatula holder, acc. to Leyla, 2 arms,
complete

Material: Stainless steel

Other Sizes:
015-0702-02 : N/A



Cardio, Neuro, Leminectomy
Fixation arm, flexible

Material: Stainless steel

Other Sizes:
015-0702-03 : N/A



Cardio, Neuro, Leminectomy
Fixation base, for 1 arm

Material: Stainless steel

Other Sizes:
015-0702-04 : N/A



Cardio, Neuro, Leminectomy
Fixation base, for 2 arms

Material: Stainless steel

Other Sizes:
015-0702-05 : N/A



Cardio, Neuro, Leminectomy
Fixation base, for 1 arm

Material: Stainless steel

Other Sizes:
015-0702-06 : N/A

CARDIO, NEURO, LEMINECTOMY



Cardio, Neuro, Leminectomy
Spatula holder, with round shaft

Material: Stainless steel

Other Sizes:
015-0702-07 : N/A



Cardio, Neuro, Leminectomy
Spatula holder, for flat spatulas

Material: Stainless steel

Other Sizes:
015-0702-08 : N/A



Cardio, Neuro, Leminectomy
Leyla retractor, 1 arm, complete

Material: Stainless steel

Other Sizes:
015-0702-11 : N/A



Cardio, Neuro, Leminectomy
Leyla retractor, 2 arms, complete

Material: Stainless steel

Other Sizes:
015-0702-12 : N/A



Cardio, Neuro, Leminectomy
Coupling head, for Leyla retractor

Material: Stainless steel

Other Sizes:
015-0702-13 : N/A



Cardio, Neuro, Leminectomy
Holding rod, for Leyla retractor

Material: Stainless steel

Other Sizes:
015-0702-14 : N/A

CARDIO, NEURO, LEMINECTOMY



Cardio, Neuro, Leminectomy
Coupling head, for 1 to 5 arms

Material: Stainless steel

Other Sizes:

015-0702-15 : N/A



Cardio, Neuro, Leminectomy
Coupling head, for 1 arm

Material: Stainless steel

Other Sizes:

015-0702-16 : N/A



Cardio, Neuro, Leminectomy
Spatula, acc. to Heifetz, malleable

Material: steel 18/8 martinit,
antimagnetic, stainless, acid-resistant

Other Sizes:

015-0720-08 : 8 x 155 mm
015-0720-11 : 11 x 155 mm
015-0720-14 : 14 x 155 mm
015-0720-17 : 17 x 155 mm



Cardio, Neuro, Leminectomy
Spatula, acc. to Heifetz, malleable,
working end rounded

Material: steel 18/8 martinit,
antimagnetic, stainless, acid-resistant

Other Sizes:

015-0721-14 : 14 x 200 mm
015-0721-17 : 17 x 200 mm
015-0721-20 : 20 x 200 mm



Cardio, Neuro, Leminectomy
Nerve hook, acc. to Groningen, angled

Material: Stainless steel

Other Sizes:

015-0738-26 : 26.5 cm



Cardio, Neuro, Leminectomy
Nerve hook, acc. to Groningen, curved

Material: Stainless steel

Other Sizes:

015-0740-26 : 26.5 cm

CARDIO, NEURO, LEMINECTOMY



Cardio, Neuro, Leminectomy
Nerve hook, acc. to Cushing no. 1

Material: Stainless steel

Other Sizes:

015-0742-19	19 cm
015-0742-28	28 cm



Cardio, Neuro, Leminectomy
Nerve hook, acc. to Cushing no. 2

Material: Stainless steel

Other Sizes:

015-0744-19	19 cm
015-0744-28	28 cm



Cardio, Neuro, Leminectomy
Nerve hook, acc. to Smithwick, curved

Material: Stainless steel

Other Sizes:

015-0748-17	16.5 cm
015-0748-21	21 cm



Cardio, Neuro, Leminectomy
Dura hooklet, acc. to Adson, blunt, angled

Material: Stainless steel

Other Sizes:

015-0823-20	20 cm
-------------	-------



Cardio, Neuro, Leminectomy
Dura hooklet, acc. to Adson, sharp, angled

Material: Stainless steel

Other Sizes:

015-0824-20	20 cm
-------------	-------



Cardio, Neuro, Leminectomy
Dura hooklet, acc. to Graham, curved, blunt

Material: Stainless steel

Other Sizes:

015-0825-16	16.5 cm
-------------	---------



Cardio, Neuro, Leminectomy
Dura hooklet, acc. to SaChs, curved, sharp

Material: Stainless steel

Other Sizes:
015-0827-18 : 17 cm



Cardio, Neuro, Leminectomy
Dura hooklet, sharp, curved, 90°

Material: Stainless steel

Other Sizes:
015-0830-19 : 1,4 mm, 19 cm
015-0831-19 : 2,5 mm, 19 cm



Cardio, Neuro, Leminectomy
Dura hooklet, acc. to Frazier, sharp

Material: Stainless steel

Other Sizes:
015-0835-13 : 13 cm
015-0835-18 : 18 cm



Cardio, Neuro, Leminectomy
Micro scissors, acc. to Vannas,
angled down

Material: Stainless steel

Other Sizes:
015-0850-01 : 12 cm



Cardio, Neuro, Leminectomy
Micro scissors, acc. to Vannas,
straight

Material: Stainless steel

Other Sizes:
015-0850-02 : 12 cm



Cardio, Neuro, Leminectomy
Micro scissors, acc. to Vannas,
curved

Material: Stainless steel

Other Sizes:
015-0850-03 : 12 cm

CARDIO, NEURO, LEMINECTOMY



Cardio, Neuro, Leminectomy
Micro scissors, acc. to Vannas, straight

Material: Stainless steel

Other Sizes:
015-0850-04 : 16 cm



Cardio, Neuro, Leminectomy
Micro scissors, acc. to Vannas, curved

Material: Stainless steel

Other Sizes:
015-0850-05 : 16 cm



Cardio, Neuro, Leminectomy
Micro scissors, acc. to Millesi, straight

Material: Stainless steel

Other Sizes:
015-0850-10 : 16 cm



Cardio, Neuro, Leminectomy
Micro scissors, acc. to Millesi, curved

Material: Stainless steel

Other Sizes:
015-0850-11 : 16 cm



Cardio, Neuro, Leminectomy
Micro scissors, acc. to acc. to Jacobson,
curved

Material: Stainless steel

Other Sizes:
015-0850-15 : 18.5 cm



Cardio, Neuro, Leminectomy
Micro scissors, acc. to acc. to Yasargil,
bayonet-shape, working end straight

Material: Stainless steel

Other Sizes:
015-0850-20 : 16.5 cm
015-0850-22 : 20 cm

CARDIO, NEURO, LEMINECTOMY



Cardio, Neuro, Leminectomy

Micro scissors, acc. to acc. to Yasargil, bayonet-shape, working end curved

Material: Stainless steel

Other Sizes:

015-0850-21	16.5 cm
015-0850-23	20 cm



Cardio, Neuro, Leminectomy

Micro scissors, acc. to acc. to Yasargil, bayonet-shape, working end curved downwards

Material: Stainless steel

Other Sizes:

015-0850-24	20 cm
-------------	-------



Cardio, Neuro, Leminectomy

Micro scissors, acc. to acc. to Yasargil, bayonet-shape, working end straight

Material: Stainless steel

Other Sizes:

015-0850-25	22.5 cm
-------------	---------



Cardio, Neuro, Leminectomy

Micro scissors, acc. to acc. to Yasargil, bayonet-shape, working end curved

Material: Stainless steel

Other Sizes:

015-0850-26	22.5 cm
015-0850-28	24.5 cm



Cardio, Neuro, Leminectomy

Micro dissecting scissors, acc. to acc. to Yasargil, straight

Material: Stainless steel

Other Sizes:

015-0850-30	20 cm
015-0850-33	22.5 cm



Cardio, Neuro, Leminectomy

Micro dissecting scissors, acc. to acc. to Yasargil, curved

Material: Stainless steel

Other Sizes:

015-0850-31	20 cm
015-0850-32	22.5 cm



Cardio, Neuro, Leminectomy
Micro scissors, acc. to Nagel,
bayonet-shape, working end curved

Material: Stainless steel

Other Sizes:
015-0850-40 : 20 cm



Cardio, Neuro, Leminectomy
Micro scissors, acc. to Nagel,
bayonet-shape, working end curved,
button ended

Material: Stainless steel

Other Sizes:
015-0850-41 : 20 cm



Cardio, Neuro, Leminectomy
Micro scissors, acc. to Nagel,
bayonet-shape, working end curved

Material: Stainless steel

Other Sizes:
015-0850-42 : 125°, 20 cm

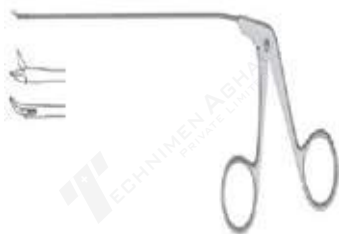

Cardio, Neuro, Leminectomy
Micro scissors, acc. to Fahlbusch, curved

Material: Stainless steel

Other Sizes:
015-0850-50 : 16.5 cm



Cardio, Neuro, Leminectomy
Micro scissors, acc. to Caspar, curved

Material: Stainless steel

Other Sizes:
015-0850-60 : 11.5 cm



Cardio, Neuro, Leminectomy
Micro needleholder, acc. to
Jacobson, without lock

Material: Stainless steel

Other Sizes:
015-0851-01 : 18 cm



Bone Surgery
Micro needleholder, acc. to acc.
to Jacobson, with lock

Material: Stainless steel

Other Sizes:
015-0851-02 : 18 cm



Bone Surgery
Micro needleholder, acc. to acc.
to Yasargil, bayonet-shape, straight

Material: Stainless steel

Other Sizes:
015-0851-10 : 20 cm
015-0851-12 : 22.5 cm



Bone Surgery
Micro needleholder, acc. to acc.
to Yasargil, bayonet-shape, curved

Material: Stainless steel

Other Sizes:
015-0851-11 : 20 cm
015-0851-13 : 22.5 cm



Bone Surgery
Grasping forceps, acc. to Samii, bayonet
right curved

Material: Stainless steel

Other Sizes:
015-0852-01 : 3 mm, 23 cm
015-0852-02 : 3 mm, 23 cm



Bone Surgery
Grasping forceps, acc. to acc. to
Yasargil-Samii, bayonet-shape

Material: Stainless steel

Other Sizes:
015-0852-10 : 3 mm, 24 cm
015-0852-11 : 5 mm, 24 cm
015-0852-12 : 7 mm, 24 cm



Bone Surgery
Grasping forceps, acc. to acc.
to Yasargil, bayonet-shape

Material: Stainless steel

Other Sizes:
015-0852-20 : 3 mm, 16.5 cm
015-0852-21 : 5 mm, 16.5 cm
015-0852-22 : 3 mm, 20 cm
015-0852-25 : 3 mm, 22 cm
015-0852-26 : 5 mm, 22 cm



Bone Surgery

Grasping forceps, acc. to Heifetz, bayonet-shape

Material: Stainless steel

Other Sizes:

015-0852-30 3 mm, 22 cm
015-0852-31 5 mm, 22 cm



Bone Surgery

Tumour forceps

Material: Stainless steel

Other Sizes:

015-0852-40 45°, 3 mm, 22 cm
015-0852-41 90°, 3 mm, 22 cm



Bone Surgery

Tiss. forceps, acc. to acc. to Yasargil

Material: Stainless steel

Other Sizes:

015-0852-50 3 mm, 22 cm



Bone Surgery

Tiss. forceps, acc. to acc. to Yasargil

Material: Stainless steel

Other Sizes:

015-0852-51 5 mm, 22 cm



Bone Surgery

Grasping forceps, acc. to Hunt, angled downwards

Material: Stainless steel

Other Sizes:

015-0852-60 5 mm, 20 cm



Bone Surgery

Grasping forceps, acc. to Hunt, bayonet-shape

Material: Stainless steel

Other Sizes:

015-0852-61 5 mm, 20 cm



Bone Surgery

Micro forceps, acc. to acc. to Yasargil, bayonet-shape

Material: Stainless steel

Other Sizes:

015-0852-70	0.6 mm, 18 cm
015-0852-73	0.6 mm, 20 cm
015-0852-75	0.6 mm, 22 cm
015-0852-77	0.6 mm, 24 cm



Bone Surgery

Micro forceps, acc. to acc. to Yasargil, bayonet-shape

Material: Stainless steel

Other Sizes:

015-0852-71	0.9 mm, 18 cm
015-0852-74	0.9 mm, 20 cm
015-0852-76	0.9 mm, 22 cm
015-0852-78	0.9 mm, 24 cm



Bone Surgery

Micro forceps, acc. to acc. to Yasargil, bayonet-shape, 1 x 2 teeth

Material: Stainless steel

Other Sizes:

015-0852-72	18 cm
-------------	-------



Bone Surgery

Tumour fork, acc. to acc. to Yasargil

Material: Stainless steel

Other Sizes:

015-0853-01	8 mm, 20 cm
015-0853-02	5 mm, 20 cm



Bone Surgery

Intestinal grasping forceps with protector

Material: Stainless steel

Other Sizes:

015-0853-03	18 mm, 18.5cm
-------------	---------------



Bone Surgery

Tumor knife, acc. to Samii

Material: Stainless steel

Other Sizes:

015-0854-01	1.0 mm, 23 cm
015-0854-02	1.5 mm, 23 cm
015-0854-03	2.0 mm, 23 cm
015-0854-04	2.5 mm, 23 cm
015-0854-05	3.0 mm, 23 cm
015-0854-06	3.5 mm, 23 cm
015-0854-07	4.0 mm, 23 cm
015-0854-08	4.5 mm, 23 cm



Bone Surgery

Tumor knife, acc. to Samii, round

Material: Stainless steel

Other Sizes:

015-0854-09	1.5 mm, 23 cm
015-0854-10	3.0 mm, 23 cm
015-0854-11	4.5 mm, 23 cm
015-0854-12	6.0 mm, 23 cm



Bone Surgery

Micro dissector, acc. to Caspar, curved

Material: Stainless steel

Other Sizes:

015-0856-01	4.5 mm, 23 cm
015-0856-04	1.0 mm, 20 cm



Bone Surgery

Micro dissector, acc. to Caspar,
curved downwards

Material: Stainless steel

Other Sizes:

015-0856-02	4.5 mm, 23 cm
015-0856-03	2.0 mm, 23 cm



Bone Surgery

Micro dissector, acc. to Caspar, curved
upwards

Material: Stainless steel

Other Sizes:

015-0856-05	1 mm, 20 cm
015-0856-06	1 mm, 20 cm



Bone Surgery

Suture fork, acc. to Caspar

Material: Stainless steel

Other Sizes:

015-0856-10	23 cm
-------------	-------



Bone Surgery

Lancet knife, acc. to Samii

Material: Stainless steel

Other Sizes:

015-0858-01	1.8 mm, 23 cm
-------------	---------------



Bone Surgery

Micro vascular knife, acc. to Koos, curved

Material: Stainless steel

Other Sizes:

015-0858-10	18.5 cm
015-0858-11	18.5 cm



Bone Surgery

Micro vascular knife, acc. to Koos, strongly curved

Material: Stainless steel

Other Sizes:

015-0858-12	18.5 cm
015-0858-13	18.5 cm



Bone Surgery

Micro vascular knife, acc. to acc. to Yasargil, curved downwards

Material: Stainless steel

Other Sizes:

015-0858-20	18.5 cm
-------------	---------



Bone Surgery

Micro vascular knife, acc. to acc. to Jacobson, straight

Material: Stainless steel

Other Sizes:

015-0858-30	18.5 cm
-------------	---------



Bone Surgery

Suture guide, acc. to acc. to Yasargil, strongly curved

Material: Stainless steel

Other Sizes:

015-0860-01	18.5 cm
-------------	---------



Bone Surgery

Suture guide, acc. to acc. to Yasargil, medium curved

Material: Stainless steel

Other Sizes:

015-0860-02	18.5 cm
015-0860-03	18.5 cm



Bone Surgery

Suture guide, acc. to acc. to Yasargil, 90°, curved

Material: Stainless steel

Other Sizes:

015-0860-04 18.5 cm



Bone Surgery

Micro raspatory, acc. to acc. to Yasargil, angled downwards

Material: Stainless steel

Other Sizes:

015-0862-01 18.5 cm
015-0862-02 18.5 cm
015-0862-03 18.5 cm
015-0862-04 18.5 cm



Bone Surgery

Micro raspatory, acc. to acc. to Yasargil, angled downwards curved

Material: Stainless steel

Other Sizes:

015-0862-05 18.5 cm
015-0862-06 18.5 cm
015-0862-07 18.5 cm



Bone Surgery

Micro raspatory, acc. to acc. to Yasargil, working end small

Material: Stainless steel

Other Sizes:

015-0862-10 23 cm
015-0862-11 23 cm
015-0862-20 23 cm

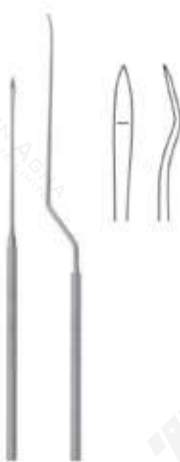

Bone Surgery

Micro dissector, acc. to acc. to Yasargil, angled downwards

Material: Stainless steel

Other Sizes:

015-0863-01 18.5 cm



Bone Surgery

Micro dissector, acc. to acc. to Yasargil, straight, slim

Material: Stainless steel

Other Sizes:

015-0863-10 23 cm
015-0863-12 23 cm
015-0863-11 23 cm
015-0863-13 23 cm



Bone Surgery

Button probe, acc. to acc. to Jacobson, angled downwards

Material: Stainless steel

Other Sizes:

015-0864-01 : 18.5 cm



Bone Surgery

Double probe, acc. to acc. to Jacobson, button ended

Material: Stainless steel

Other Sizes:

015-0864-02 : 18.5 cm



Bone Surgery

Micro curette, acc. to acc. to Yasargil, sharp

Material: Stainless steel

Other Sizes:

015-0865-01 : 18.5 cm



Bone Surgery

Micro curette, sharp, straight

Material: Stainless steel

Other Sizes:

015-0865-10 : 23 cm



Bone Surgery

Micro curette, sharp, angled upwards, straight

Material: Stainless steel

Other Sizes:

015-0865-11 : 23 cm



Bone Surgery

Micro hooklet, sharp

Material: Stainless steel

Other Sizes:

015-0866-01 : 4.0 mm, 23 cm
015-0866-02 : 3.8 mm, 23 cm



Bone Surgery

Nerve hook, acc. to Krayenbuehl

Material: Stainless steel

Other Sizes:

015-0940-01	19 cm
015-0940-02	19 cm
015-0940-03	19 cm
015-0940-04	19 cm



Bone Surgery

Hooklet, acc. to Caspar, 24.5 cm

Material: Stainless steel

Other Sizes:

015-0942-05	90°, 5 mm
015-0942-07	90°, 7 mm
015-0942-09	90°, 9 mm
015-0942-11	45°, 11 mm



Bone Surgery

Vertebral spreader, acc. to Cloward

Material: Stainless steel

Other Sizes:

015-0973-16	16 cm
-------------	-------



Bone Surgery

Bone spreader, acc. to Cloward, pacc. to Lane

Material: Stainless steel

Other Sizes:

015-0974-17	16 cm
-------------	-------



Bone Surgery

Vertebral spreader, acc. to Inge

Material: Stainless steel

Other Sizes:

015-0975-17	16 cm
-------------	-------



Bone Surgery

Vertebral spreader, acc. to Inge

Material: Stainless steel

Other Sizes:

015-0977-27	25.5 cm
-------------	---------



Bone Surgery
Ferris-Smith-Kerrison, 40°

Material: Stainless steel

Other Sizes:

015-0978-01	1 mm, 18 cm
015-0978-09	2 mm, 18 cm
015-0978-17	3 mm, 18 cm
015-0978-25	4 mm, 18 cm
015-0978-33	5 mm, 18 cm
015-0978-41	6 mm, 18 cm
015-0978-03	1 mm, 20 cm
015-0978-11	2 mm, 20 cm
015-0978-19	3 mm, 20 cm
015-0978-27	4 mm, 20 cm
015-0978-35	5 mm, 20 cm
015-0978-43	6 mm, 20 cm



Bone Surgery
Ferris-Smith-Kerrison, 90°

Material: Stainless steel

Other Sizes:

015-0978-02	1 mm, 18 cm
015-0978-10	2 mm, 18 cm
015-0978-18	3 mm, 18 cm
015-0978-26	4 mm, 18 cm
015-0978-34	5 mm, 18 cm
015-0978-42	6 mm, 18 cm
015-0978-04	1 mm, 20 cm
015-0978-12	2 mm, 20 cm
015-0978-20	3 mm, 20 cm
015-0978-28	4 mm, 20 cm
015-0978-36	5 mm, 20 cm
015-0978-44	6 mm, 20 cm



Bone Surgery
Ferris-Smith-Kerrison, 40°

Material: Stainless steel

Other Sizes:

015-0978-50	1 mm, 18 cm
015-0978-56	2 mm, 18 cm
015-0978-62	3 mm, 18 cm
015-0978-68	4 mm, 18 cm
015-0978-74	5 mm, 18 cm
015-0978-80	6 mm, 18 cm
015-0978-52	1 mm, 20 cm
015-0978-58	2 mm, 20 cm
015-0978-64	3 mm, 20 cm
015-0978-70	4 mm, 20 cm
015-0978-76	5 mm, 20 cm
015-0978-82	6 mm, 20 cm
015-0978-54	1 mm, 23 cm
015-0978-60	2 mm, 23 cm
015-0978-66	3 mm, 23 cm
015-0978-72	4 mm, 23 cm
015-0978-78	5 mm, 23 cm
015-0978-84	6 mm, 23 cm



Bone Surgery
Ferris-Smith-Kerrison, 40°

Material: Stainless steel

Other Sizes:

015-0979-01	1 mm, 18 cm
015-0979-09	2 mm, 18 cm
015-0979-17	3 mm, 18 cm
015-0979-25	4 mm, 18 cm
015-0979-33	5 mm, 18 cm
015-0979-41	6 mm, 18 cm
015-0979-03	1 mm, 20 cm
015-0979-11	2 mm, 20 cm
015-0979-19	3 mm, 20 cm
015-0979-27	4 mm, 20 cm
015-0979-35	5 mm, 20 cm
015-0979-43	6 mm, 20 cm



Bone Surgery
Ferris-Smith-Kerrison, 40°

Material: Stainless steel

Other Sizes:

015-0978-90	1 mm, 18 cm
-------------	-------------

CARDIO, NEURO, LEMINECTOMY

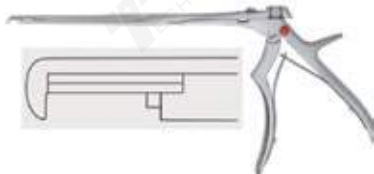

Bone Surgery

Ferris-Smith-Kerrison, 90°

Material: Stainless steel

Other Sizes:

015-0978-51	1 mm, 18 cm
015-0978-57	2 mm, 18 cm
015-0978-63	3 mm, 18 cm
015-0978-69	4 mm, 18 cm
015-0978-75	5 mm, 18 cm
015-0978-81	6 mm, 18 cm
015-0978-53	1 mm, 20 cm
015-0978-59	2 mm, 20 cm
015-0978-65	3 mm, 20 cm
015-0978-71	4 mm, 20 cm
015-0978-77	5 mm, 20 cm
015-0978-83	6 mm, 20 cm
015-0978-55	1 mm, 23 cm
015-0978-61	2 mm, 23 cm
015-0978-67	3 mm, 23 cm
015-0978-73	4 mm, 23 cm
015-0978-79	5 mm, 23 cm
015-0978-85	6 mm, 23 cm



Bone Surgery

Ferris-Smith-Kerrison, 90°

Material: Stainless steel

Other Sizes:

015-0979-02	1 mm, 18 cm
015-0979-10	2 mm, 18 cm
015-0979-18	3 mm, 18 cm
015-0979-26	4 mm, 18 cm
015-0979-34	5 mm, 18 cm
015-0979-42	6 mm, 18 cm
015-0979-04	1 mm, 20 cm
015-0979-12	2 mm, 20 cm
015-0979-20	3 mm, 20 mm
015-0979-28	4 mm, 20 mm
015-0979-36	5 mm, 20 cm
015-0979-44	6 mm, 20 cm

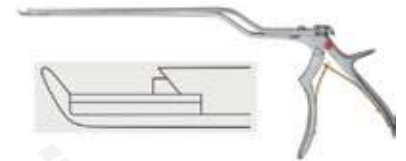

Bone Surgery

Ferris-Smith-Kerrison, 40°

Material: Stainless steel

Other Sizes:

015-0979-05	1 mm, 23 cm
015-0979-13	2 mm, 23 cm
015-0979-21	3 mm, 23 cm
015-0979-29	4 mm, 23 cm
015-0979-37	5 mm, 23 cm
015-0979-45	6 mm, 23 cm
015-0979-07	1 mm, 28 cm
015-0979-15	2 mm, 28 cm
015-0979-23	3 mm, 28 cm
015-0979-31	4 mm, 28 cm
015-0979-39	5 mm, 28 cm
015-0979-47	6 mm, 28 cm



Bone Surgery

Ferris-Smith-Kerrison, 40°

Material: Stainless steel

Other Sizes:

015-0979-70	1 mm, 18 cm
015-0979-71	2 mm, 18 cm
015-0979-72	3 mm, 18 cm
015-0979-73	4 mm, 18 cm
015-0979-74	5 mm, 18 cm
015-0979-75	6 mm, 18 cm



Bone Surgery

Ferris-Smith-Kerrison, 40°

Material: Stainless steel

Other Sizes:

015-0979-80	1 mm, 18 cm
015-0979-81	2 mm, 18 cm
015-0979-82	3 mm, 18 cm
015-0979-83	4 mm, 18 cm
015-0979-84	5 mm, 18 cm

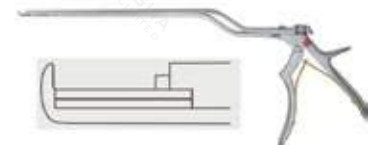

Bone Surgery

Ferris-Smith-Kerrison, 90°

Material: Stainless steel

Other Sizes:

015-0979-51	1 mm, 15 cm
015-0979-55	2 mm, 15 cm
015-0979-59	3 mm, 15 cm
015-0979-63	4 mm, 15 cm
015-0979-67	5 mm, 15 cm
015-0979-53	1 mm, 18 cm
015-0979-57	2 mm, 18 cm
015-0979-61	3 mm, 18 cm
015-0979-65	4 mm, 18 cm
015-0979-69	5 mm, 18 cm

CARDIO, NEURO, LEMINECTOMY



Bone Surgery

N/A

Material: Stainless steel

Other Sizes:

015-0979-85	1 mm, 20 cm
015-0979-86	2 mm, 20 cm
015-0979-87	3 mm, 20 cm
015-0979-88	4 mm, 20 cm
015-0979-89	5 mm, 20 cm
015-0979-90	6 mm, 20 cm



Bone Surgery

Ferris-Smith-Kerrison, 90°

Material: Stainless steel

Other Sizes:

015-0979-91	1 mm, 20 cm
015-0979-92	2 mm, 20 cm
015-0979-93	3 mm, 20 mm
015-0979-94	4 mm, 20 cm
015-0979-95	5 mm, 20 cm
015-0979-96	6 mm, 20 cm

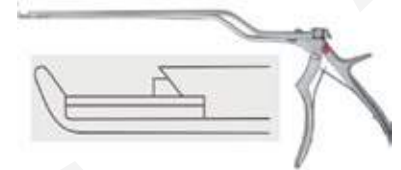

Bone Surgery

Ferris-Smith-Kerrison, 40°

Material: Stainless steel

Other Sizes:

015-0980-01	1 mm, 15 cm
015-0980-05	2 mm, 15 cm
015-0980-09	3 mm, 15 cm
015-0980-13	4 mm, 15 cm
015-0980-17	5 mm, 15 cm
015-0980-03	1 mm, 18 cm
015-0980-07	2 mm, 18 cm
015-0980-11	3 mm, 18 cm
015-0980-15	4 mm, 18 cm
015-0980-19	5 mm, 18 cm

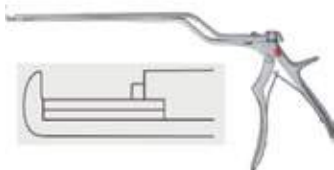

Bone Surgery

Ferris-Smith-Kerrison, 90°

Material: Stainless steel

Other Sizes:

015-0980-02	1 mm, 15 cm
015-0980-06	2 mm, 15 cm
015-0980-10	3 mm, 15 cm
015-0980-14	4 mm, 15 cm
015-0980-18	5 mm, 15 cm
015-0980-04	1 mm, 18 cm
015-0980-08	2 mm, 18 cm
015-0980-12	3 mm, 18 cm
015-0980-16	4 mm, 18 cm
015-0980-20	5 mm, 18 cm

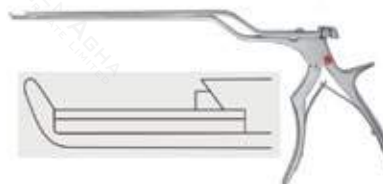

Bone Surgery

Ferris-Smith-Kerrison, 40°

Material: Stainless steel

Other Sizes:

015-0980-21	1 mm, 18 cm
015-0980-22	2 mm, 18 cm
015-0980-23	3 mm, 18 cm
015-0980-24	4 mm, 18 cm
015-0980-25	5 mm, 18 cm

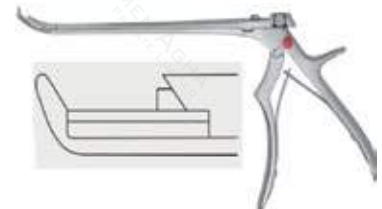

Bone Surgery

Ferris-Smith-Kerrison, Punch, with ejector, detachable, 40°

Material: Stainless steel

Other Sizes:

015-0980-30	1 mm, 20 cm
015-0980-33	2 mm, 20 cm
015-0980-36	3 mm, 20 cm
015-0980-39	4 mm, 20 cm
015-0980-42	5 mm, 20 cm

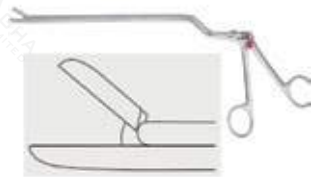

Bone Surgery

Caspar, detachable, straight, bayonet

Material: Stainless steel

Other Sizes:

015-0981-61	2 mm, 15 cm
015-0981-62	3 mm, 15 cm
015-0981-63	4 mm, 15 cm
015-0981-64	5 mm, 15 cm
015-0981-65	2 mm, 18 cm
015-0981-66	3 mm, 18 cm
015-0981-67	4 mm, 18 cm
015-0981-68	5 mm, 18 cm

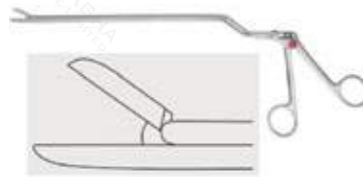

Bone Surgery

Caspar, detachable, straight

Material: Stainless steel

Other Sizes:

015-0981-05	2 mm, 15 cm
015-0981-06	3 mm, 15 cm
015-0981-07	4 mm, 15 cm
015-0981-08	5 mm, 15 cm
015-0981-09	2 mm, 18 cm
015-0981-10	3 mm, 18 cm
015-0981-11	4 mm, 18 cm
015-0981-12	5 mm, 18 cm
015-0981-13	2 mm, 20 cm
015-0981-14	3 mm, 20 cm
015-0981-15	4 mm, 20 cm
015-0981-16	5 mm, 20 cm
015-0981-17	2 mm, 30 cm
015-0981-18	3 mm, 30 cm
015-0981-19	4 mm, 30 cm
015-0981-20	5 mm, 30 cm

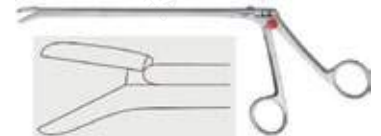

Bone Surgery

Caspar, angled downward, 30°

Material: Stainless steel

Other Sizes:

015-0981-45	2 mm, 15 cm
015-0981-46	3 mm, 15 cm
015-0981-47	4 mm, 15 cm
015-0981-48	5 mm, 15 cm
015-0981-49	2 mm, 18 cm
015-0981-50	3 mm, 18 cm
015-0981-51	4 mm, 18 cm
015-0981-52	5 mm, 18 cm
015-0981-53	2 mm, 20 cm
015-0981-54	3 mm, 20 cm
015-0981-55	4 mm, 20 cm
015-0981-56	5 mm, 20 cm
015-0981-57	2 mm, 23 cm
015-0981-58	3 mm, 23 cm
015-0981-59	4 mm, 23 cm
015-0981-60	5 mm, 23 cm

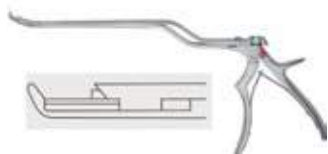

Bone Surgery

Ferris-Smith-Kerrison, Punch, with ejector, detachable, curved, bayonet, 40°

Material: Stainless steel

Other Sizes:

015-0980-50 : 3 mm, 18 cm



Bone Surgery

Pituitary forceps, acc. to Oldberg, 25 cm, shaft length, 180 mm

Material: Stainless steel

Other Sizes:

015-0996-25 : 25 cm



Bone Surgery

Tumor grasping forceps, acc. to Landolt, 27 cm, shaft length 185 mm

Material: Stainless steel

Other Sizes:

015-0996-27 : 27 cm



Bone Surgery

Pituitary forceps, acc. to Yasargil, 25.5 cm, shaft length 180 mm

Material: Stainless steel

Other Sizes:

015-0996-50 : 25.5 cm
015-0996-51 : 25.5 cm



Bone Surgery

Pituitary specula, acc. to Papavero-Caspar

Material: Stainless steel

Other Sizes:

015-0998-08 : 80 x 13 mm
015-0998-09 : 90 x 13 mm
015-0998-10 : 100 x 13 mm



Bone Surgery

Pituitary specula, acc. to Cushing-Landolt

Material: Stainless steel

Other Sizes:

015-0999-07 : 70 x 15 mm
015-0999-09 : 90 x 15 mm
015-0999-11 : 110 x 15 mm

TRACHEOTOMY

— RANGE

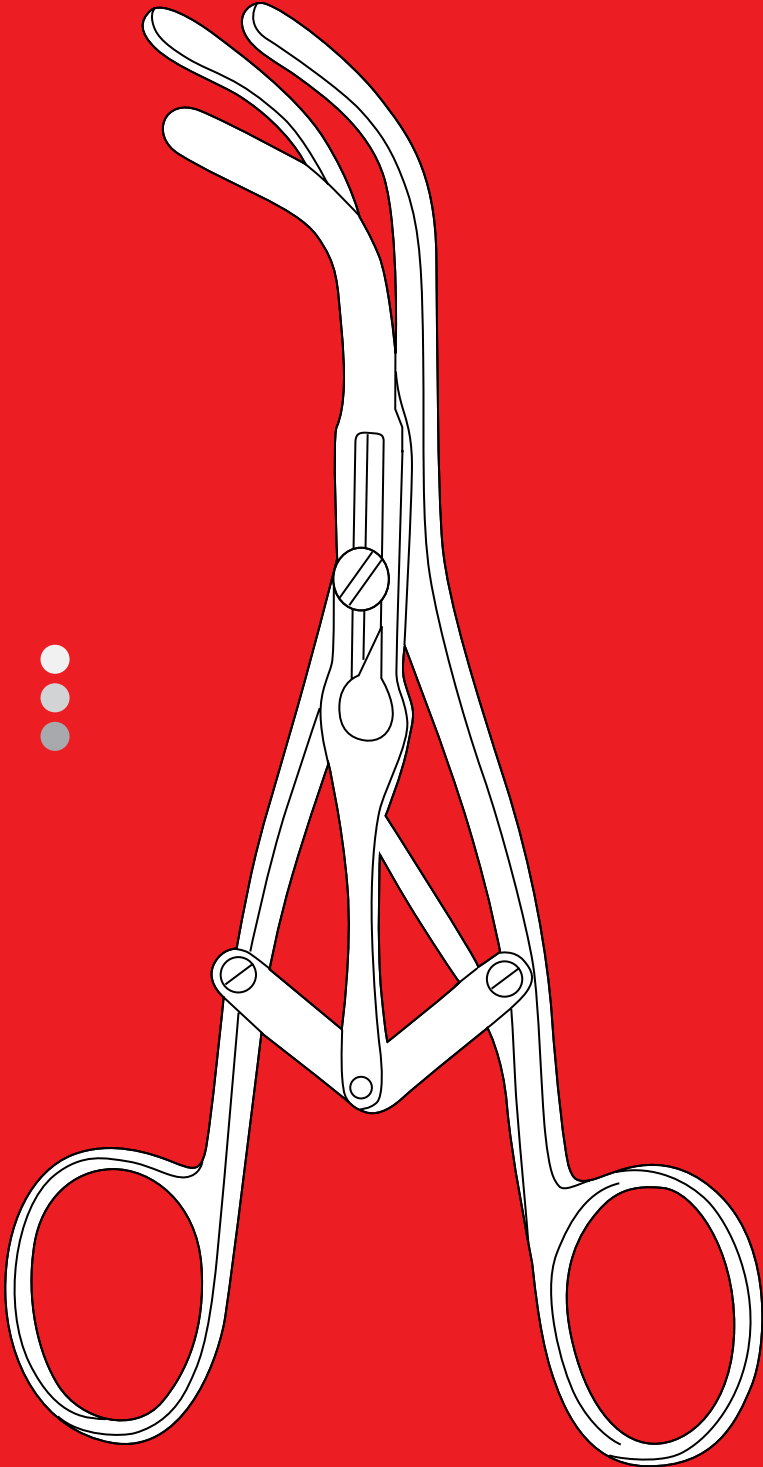

DISCOVER NOW

“Instruments for
surgical procedures”
Since 1970

TRACHEOTOMY



Tracheotomy
TraCheal dilator, acc. to Laborde

Material: Stainless steel

Other Sizes:
016-0113-14 14 cm



Tracheotomy
TraCheal dilator, acc. to Trousseau

Material: Stainless steel

Other Sizes:
016-0115-14 14.5 cm



Tracheotomy
TraCheal retractor, acc. to Iterson, sharp

Material: Stainless steel

Other Sizes:
016-0125-16 17 cm



Tracheotomy
TraCheal retractor, acc. to Iterson, blunt

Material: Stainless steel

Other Sizes:
016-0127-16 17 cm



Tracheotomy
TraCheal retractor, acc. to Rose, double-ended

Material: Stainless steel

Other Sizes:
016-0143-13 13.5 cm



Tracheotomy
TraCheal retractor, acc. to Luer, double-ended

Material: Stainless steel

Other Sizes:
016-0145-11 11 cm

TRACHEOTOMY



Tracheotomy
N/A

Material: Stainless steel

Other Sizes:
016-0149-15 : 15 cm



Tracheotomy
Thymus-Retractor, acc. to Lukens,
double-ended

Material: Stainless steel

Other Sizes:
016-0151-17 : 17.5 cm



Tracheotomy
TraCheal-Retractor, acc. to Jackson,
double-ended

Material: Stainless steel

Other Sizes:
016-0155-17 : 18 cm



Tracheotomy
Goitre probe, acc. to KoCher,
without hole

Material: Stainless steel

Other Sizes:
016-0411-15 : 15.5 cm



Tracheotomy
Goitre probe, acc. to KoCher,
with hole

Material: Stainless steel

Other Sizes:
016-0413-15 : 15.5 cm



Tracheotomy
Goitre grasping forceps, acc.
to Lahey, 3 x 3 teeth

Material: Stainless steel

Other Sizes:
016-0449-15 : 15.5 cm
016-0449-20 : 20 cm

DERMATOLOGY

— RANGE



DISCOVER NOW

“Instruments for
surgical procedures”
Since 1970



Dermatology
Lupus scraper, acc. to Vidal

Material: Stainless steel

Other Sizes:
017-0135-14 : 13 cm



Dermatology
Lupus curette, acc. to Fox , straight

Material: Stainless steel

Other Sizes:
017-0188-01 : 3 mm, 14 cm
017-0188-02 : 3,8 mm, 14 cm
017-0188-03 : 5.8 mm, 14 cm
017-0188-04 : 6 mm, 14 cm



Dermatology
Lupus scoop, acc. to Wolff

Material: Stainless steel

Other Sizes:
017-0196-01 : 5,0 mm, 14 cm
017-0196-02 : 5,5 mm, 14 cm
017-0196-03 : 6 mm, 14 cm
017-0196-04 : 6,5 mm, 14 cm
017-0196-05 : 7,2 mm, 14 cm
017-0196-06 : 8,0 mm, 14 cm



Dermatology
Skin hooklet, acc. to Kilner, gracile

Material: Stainless steel

Other Sizes:
017-0203-15 : 14.5 cm



Dermatology
Skin hooklet, acc. to Gillies

Material: Stainless steel

Other Sizes:
017-0207-18 : 18 cm



Dermatology
Skin hooklet, acc. to Gillies

Material: Stainless steel

Other Sizes:
017-0209-18 : 18 cm



Dermatology
Face-lift hooklet, acc. to Kaye, 4 prongs

Material: Stainless steel

Other Sizes:
017-0215-03 13 cm



Dermatology
Face-lift hooklet, acc. to Kaye, 5 prongs

Material: Stainless steel

Other Sizes:
017-0215-04 13 cm



Dermatology
Dermal punCh, acc. to Keyes, with Handle

Material: Stainless steel

Other Sizes:
017-0240-01 Ø 1 mm
017-0240-02 Ø 2 mm
017-0240-03 Ø 3 mm
017-0240-04 Ø 4 mm
017-0240-05 Ø 5 mm
017-0240-06 Ø 6 mm
017-0240-07 Ø 7 mm
017-0240-08 Ø 8 mm

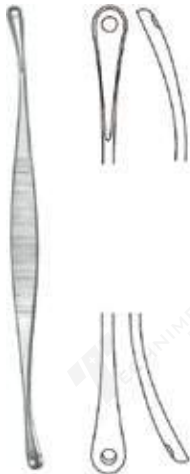

Dermatology
Comedone extractor, acc. to Unna

Material: Stainless steel

Other Sizes:
017-0261-14 14,5 cm



Dermatology
Comedone extractor, acc. to Unna

Material: Stainless steel

Other Sizes:
017-0263-14 14 cm



Dermatology
Comedone extractor, acc. to Saalfeld

Material: Stainless steel

Other Sizes:
017-0271-10 11 cm

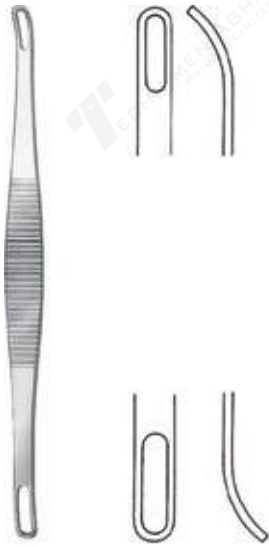

Dermatology
Comedone extractor, acc. to Schamberg

Material: Stainless steel

Other Sizes:
017-0279-10 : 9.5 cm



Dermatology
Comedone extractor, acc. to KatsCh, with protective metal cap

Material: Stainless steel

Other Sizes:
017-0294-14 : 16 cm



Dermatology
Comedone extractor, acc. to Unna-Vidal

Material: Stainless steel

Other Sizes:
017-0296-11 : 11 cm



Dermatology
Face-lift forceps, acc. to d'Assumpcao

Material: Stainless steel

Other Sizes:
017-0300-15 : 16 cm



Dermatology
Face-lift scissors, TC GOLD, acc. to Gregory, curved, serrated

Material: Stainless steel

Other Sizes:
017-0501-14 : 14 cm



Dermatology
Face-lift scissors, TC GOLD, acc. to Kaye, curved, serrated

Material: Stainless steel

Other Sizes:
017-0503-15 : 15 cm



Dermatology
Face-lift scissors, TC GOLD, acc. to Kaye, curved, serrated

Material: Stainless steel

Other Sizes:
017-0503-18 : 18 cm



Dermatology
Face-lift scissors, TC GOLD, acc. to Stella-S, curved, serrated

Material: Stainless steel

Other Sizes:
017-0505-18 : 18 cm



Dermatology
Thomas, serrated, super-edge

Material: Stainless steel

Other Sizes:
017-0511-14 : 14 cm
017-0511-18 : 18 cm



Dermatology
Marinus, serrated, super-edge

Material: Stainless steel

Other Sizes:
017-0517-15 : 15 cm
017-0517-19 : 19 cm



Dermatology
Face-lift scissors, TC GOLD, acc. to Freeman-Kaye, curved, serrated

Material: Stainless steel

Other Sizes:
017-0525-18 : 18 cm



Dermatology
Face-lift scissors, TC GOLD, acc. to Freeman, curved, serrated

Material: Stainless steel

Other Sizes:
017-0529-23 : 23 cm



Dermatology
Face-lift scissors, TC GOLD, acc. to Gorney, curved, serrated

Material: Stainless steel

Other Sizes:
017-0521-18 : 18 cm

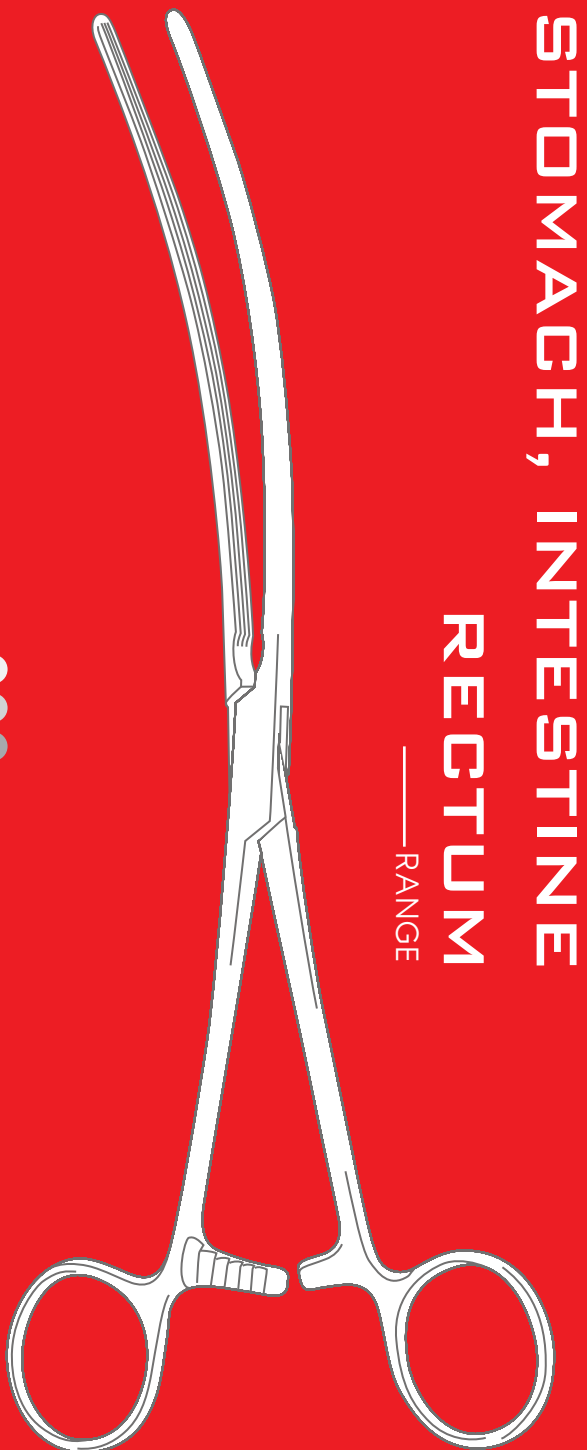

**STOMACH, INTESTINE
RECTUM**
____ RANGE



DISCOVER NOW

“Instruments for
surgical procedures”
Since 1970



Stomach, Intestine, Rectum
Intestinal grasping forceps, acc.
to Allis-Baby, 4 x 5 teeth

Material: Stainless steel

Other Sizes:
018-0130-12 15.5 cm



Stomach, Intestine, Rectum
Intestinal grasping forceps, acc.
to Allis, 4 x 5 teeth

Material: Stainless steel

Other Sizes:
018-0132-15 15.5 cm



Stomach, Intestine, Rectum
Intestinal grasping forceps, acc.
to Allis, 5 x 6 teeth

Material: Stainless steel

Other Sizes:
018-0134-15 15.5 cm
018-0134-19 19 cm
018-0134-25 25.5 cm



Stomach, Intestine, Rectum
Atraumatic intestinal grasping forceps,
acc. to Allis

Material: Stainless steel

Other Sizes:
018-0136-16 15.5 cm
018-0136-20 20 cm
018-0136-25 24.5 cm
018-0136-30 30 cm



Stomach, Intestine, Rectum
Intestinal grasping forceps, acc.
to Allis, 11 x 12 teeth

Material: Stainless steel

Other Sizes:
018-0138-15 16 cm



Stomach, Intestine, Rectum
Intestinal grasping forceps, acc.
to Boys-Allis, 5 x 6 teeth

Material: Stainless steel

Other Sizes:
018-0142-15 15.5 cm

STOMACH, INTESTINE RECTUM



Stomach, Intestine, Rectum
Intestinal grasping forceps, acc.
to Judd-Allis, 3 x 4 teeth

Material: Stainless steel

Other Sizes:

018-0148-15	15.5 cm
018-0148-19	19 cm



Stomach, Intestine, Rectum
Intestinal grasping forceps, acc.
to Thoms-Allis, 6 x 7 teeth

Material: Stainless steel

Other Sizes:

018-0150-20	20.5 cm
-------------	---------



Stomach, Intestine, Rectum
Intestinal grasping forceps, acc.
to Allis, 5 x 6 teeth

Material: Stainless steel

Other Sizes:

018-0154-20	20 cm
-------------	-------



Stomach, Intestine, Rectum
Intestinal grasping forceps, acc.
to Lockwood, fenestrated

Material: Stainless steel

Other Sizes:

018-0170-20	20 cm
-------------	-------



Stomach, Intestine, Rectum
Intestinal grasping forceps, acc.
to Williams, fenestrated

Material: Stainless steel

Other Sizes:

018-0186-16	16.5 cm
-------------	---------



Stomach, Intestine, Rectum
Intestinal grasping forceps,
TC GOLD, acc. to Babcock

Material: Stainless steel

Other Sizes:

018-0190-16	16.5 cm
018-0190-20	21 cm

STOMACH, INTESTINE RECTUM



Stomach, Intestine, Rectum
Intestinal grasping forceps, acc.
to Babcock

Material: Stainless steel

Other Sizes:

018-0192-16	15.5 cm
018-0192-18	17.5 cm
018-0192-20	21 cm
018-0192-24	24 cm



Stomach, Intestine, Rectum
Atraumatic Intestinal grasping
forceps, acc. to Babcock

Material: Stainless steel

Other Sizes:

018-0196-16	16 cm
-------------	-------



Stomach, Intestine, Rectum
Atraumatic Intestinal grasping
forceps, acc. to Babcock

Material: Stainless steel

Other Sizes:

018-0196-20	20.5 cm
-------------	---------



Stomach, Intestine, Rectum
Intestinal grasping forceps,
TC GOLD, acc. to Duval

Material: Stainless steel

Other Sizes:

018-0206-20	20.5 cm
-------------	---------



Stomach, Intestine, Rectum
Intestinal grasping forceps, acc.
to Duval, slim

Material: Stainless steel

Other Sizes:

018-0210-18	18 cm
018-0210-20	20.5 cm



Stomach, Intestine, Rectum
Intestinal grasping forceps, acc.
to Duval, wide

Material: Stainless steel

Other Sizes:

018-0212-20	20.5 cm
018-0212-23	23 cm

STOMACH, INTESTINE RECTUM



Stomach, Intestine, Rectum
N/A

Material: Stainless steel

Other Sizes:

018-0266-25	25 cm
018-0266-26	26 cm



Stomach, Intestine, Rectum
Intestinal clamps, acc. to Doyen,
straight

Material: Stainless steel

Other Sizes:

018-0274-21	21.5 cm
018-0274-23	23.5 cm



Stomach, Intestine, Rectum
Intestinal clamps, acc. to Doyen,
curved

Material: Stainless steel

Other Sizes:

018-0275-21	21 cm
018-0275-23	23 cm



Stomach, Intestine, Rectum
Intestinal clamps, acc. to Doyen-
Baby, straight

Material: Stainless steel

Other Sizes:

018-0276-18	18 cm
-------------	-------



Stomach, Intestine, Rectum
Intestinal clamps, acc. to Doyen-
Baby, curved

Material: Stainless steel

Other Sizes:

018-0277-18	17.5 cm
-------------	---------



Stomach, Intestine, Rectum
Intestinal clamps, acc. to Mayo-
Robson, straight

Material: Stainless steel

Other Sizes:

018-0286-21	21.5 cm
018-0286-23	23.5 cm

STOMACH, INTESTINE RECTUM



Stomach, Intestine, Rectum
Intestinal clamps, acc. to Mayo-
Robson, curved

Material: Stainless steel

Other Sizes:

018-0287-21 : 21 cm
018-0287-23 : 23 cm



Stomach, Intestine, Rectum
Intestinal clamps, acc. to Mayo-
Robson, straight

Material: Stainless steel

Other Sizes:

018-0288-25 : 25.5 cm

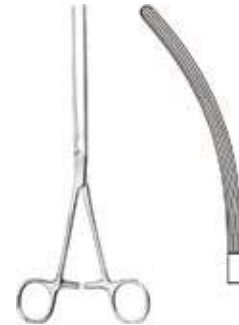

Stomach, Intestine, Rectum
Intestinal clamps, acc. to Mayo-
Robson, curved

Material: Stainless steel

Other Sizes:

018-0289-25 : 24.5 cm



Stomach, Intestine, Rectum
Intestinal clamps, acc. to KoCher,
soft, straight

Material: Stainless steel

Other Sizes:

018-0304-22 : 22.5 cm
018-0304-25 : 25 cm
018-0304-28 : 28.5 cm



Stomach, Intestine, Rectum
Intestinal clamps, acc. to KoCher,
soft, curved

Material: Stainless steel

Other Sizes:

018-0305-22 : 22 cm
018-0305-25 : 24.5 cm
018-0305-28 : 27.5 cm



Stomach, Intestine, Rectum
Intestinal clamps, acc. to Allen, Child,
straight

Material: Stainless steel

Other Sizes:

018-0398-16 : 16 cm

STOMACH, INTESTINE RECTUM



Stomach, Intestine, Rectum
Intestinal and pylorus clamp,
acc. to Payr-Baby

Material: Stainless steel

Other Sizes:

018-0415-15 : 15 cm



Stomach, Intestine, Rectum
Intestinal and pylorus clamp, acc.
to Payr

Material: Stainless steel

Other Sizes:

018-0419-21 : 20.5 cm



Stomach, Intestine, Rectum
Intestinal and pylorus clamp, acc.
to Payr

Material: Stainless steel

Other Sizes:

018-0425-29 : 29 cm



Stomach, Intestine, Rectum
Intestinal and pylorus clamp, acc. to Payr

Material: Stainless steel

Other Sizes:

018-0433-35 : 34.5 cm



Stomach, Intestine, Rectum
Intestinal anastomosis clamps, acc.
to de Martel-Wolfson, set

Material: Stainless steel

Other Sizes:

018-0496-05 : 65 mm
018-0496-07 : 80 mm
018-0496-10 : 110 mm



Stomach, Intestine, Rectum
Closing forceps, acc. to de Martel-Wolfson

Material: octagonal handle

Other Sizes:

018-0497-26 : 27 cm

MAGEN, DARM,
ESTÓMAGO,
RECTUM

REKTUM
INTESTINOS,
STOMACO,

STOMACH,
RECTO
INTESTINI,

INTESTINES,
ESTOMAC,
RETTO

RECTUM
INTESTINS,

STOMACH, INTESTINE RECTUM



Stomach, Intestine, Rectum
Clamp holder, acc. to de Martel-Wolfson

Material: Stainless steel

Other Sizes:
018-0498-08 : 9.5 cm



Stomach, Intestine, Rectum
Clamp holder, acc. to de Martel-Wolfson

Material: Stainless steel

Other Sizes:
018-0498-23 : 23 cm



Stomach, Intestine, Rectum
Pylorus spreader, acc. to Benson

Material: Stainless steel

Other Sizes:
018-0519-16 : 15.5 cm



Stomach, Intestine, Rectum
Intestinal clamp, acc. to Stone-Watt

Material: Stainless steel

Other Sizes:
018-0520-07 : 8.5 cm



Stomach, Intestine, Rectum
Locking device for 018-0520-07
18-0520-10, acc. to Stone-Watt

Material: Stainless steel

Other Sizes:
018-0522-00 : N/A



Stomach, Intestine, Rectum
Closing forceps for 018-0520-07
018-0520-10, acc. to Stone-Watt, 16 cm

Material: Stainless steel

Other Sizes:
018-0524-15 : 16 cm

STOMACH, INTESTINE RECTUM



Stomach, Intestine, Rectum
StomaCh and intestinal anastomosis
twin clamp, acc. to Lane, straight

Material: Stainless steel

Other Sizes:
018-0534-30 : 30 cm



Stomach, Intestine, Rectum
StomaCh and intestinal anastomosis
twin clamp, acc. to Lane, curved

Material: Stainless steel

Other Sizes:
018-0535-30 : 30 cm



Stomach, Intestine, Rectum
Atraumatic organ grasping forceps,
acc. to SCheibe, narrow

Material: Stainless steel

Other Sizes:
018-0540-18 : 18 cm
018-0540-20 : 20.5 cm
018-0540-23 : 23 cm



Stomach, Intestine, Rectum
Atraumatic intestinal clamps, acc.
to Doyen-Baby, straight

Material: Stainless steel

Other Sizes:
018-0550-13 : 14 cm
018-0550-16 : 17 cm
018-0550-18 : 18.5 cm
018-0550-21 : 21.5 cm
018-0550-23 : 23.5 cm



Stomach, Intestine, Rectum
Atraumatic intestinal clamps, acc.
to Doyen-Baby, curved

Material: Stainless steel

Other Sizes:
018-0551-13 : 13.5 cm
018-0551-16 : 17 cm
018-0551-18 : 18 cm
018-0551-21 : 21 cm
018-0551-23 : 23 cm

STOMACH, INTESTINE RECTUM



Stomach, Intestine, Rectum
Atraumatic intestinal clamps, acc.
to Mayo-Robson, straight

Material: Stainless steel

Other Sizes:
018-0554-25 : 26 cm



Stomach, Intestine, Rectum
Atraumatic intestinal clamps, acc.
to Mayo-Robson, curved

Material: Stainless steel

Other Sizes:
018-0555-25 : 25 cm



Stomach, Intestine, Rectum
Atraumatic intestinal clamps, acc.
to KoCher, straight

Material: Stainless steel

Other Sizes:
018-0560-22 : 22.5 cm
018-0560-25 : 25.5 cm
018-0560-28 : 28 cm



Stomach, Intestine, Rectum
Atraumatic intestinal clamps, acc.
to KoCher, curved

Material: Stainless steel

Other Sizes:
018-0561-22 : 22 cm
018-0561-25 : 25 cm
018-0561-28 : 27.5 cm



Stomach, Intestine, Rectum
Atraumatic intestinal forceps, acc.
to Scudder, straight

Material: Stainless steel

Other Sizes:
018-0570-33 : 23.5 cm



Stomach, Intestine, Rectum
Atraumatic intestinal forceps, acc.
to Scudder, curved

Material: Stainless steel

Other Sizes:
018-0571-33 : 32.5 cm

STOMACH, INTESTINE RECTUM



Stomach, Intestine, Rectum
Atraumatic intestinal forceps, acc.
to Brunner, bayonet-shape

Material: Stainless steel

Other Sizes:
018-0580-24 : 27 cm



Stomach, Intestine, Rectum
Atraumatic rectum forceps, acc.
to Hayes, angled

Material: Stainless steel

Other Sizes:
018-0581-26 : 27 cm
018-0581-28 : 28 cm



Stomach, Intestine, Rectum
Atraumatic rectum forceps, acc.
to Veidenheimer

Material: Stainless steel

Other Sizes:
018-0583-23 : 25 cm



Stomach, Intestine, Rectum
Atraumatic resection forceps, acc.
to Fehland

Material: Stainless steel

Other Sizes:
018-0585-24 : 24 cm



Stomach, Intestine, Rectum
Atraumatic rectum forceps, acc.
to Resano

Material: Stainless steel

Other Sizes:
018-0587-30 : 28 cm



Stomach, Intestine, Rectum
Rectal speculum, acc. to Czerny

Material: Stainless steel

Other Sizes:
018-0610-21 : 22.5 cm

STOMACH, INTESTINE RECTUM



Stomach, Intestine, Rectum
Rectal speculum, acc. to acc. to Sims

Material: Stainless steel

Other Sizes:
018-0613-15 : 15.5 cm



Stomach, Intestine, Rectum
Rectal speculum, acc. to acc. to Sims, fenestrated

Material: Stainless steel

Other Sizes:
018-0615-15 : 15.5 cm



Stomach, Intestine, Rectum
Rectal speculum, acc. to Pratt

Material: Stainless steel

Other Sizes:
018-0624-20 : 20 cm, 80 x 25 mm



Stomach, Intestine, Rectum
Rectal Spreaders, acc. to Ives-Fansler, Ø 22 mm, working length

Material: Stainless steel

Other Sizes:
018-0641-15 : 80 mm



Stomach, Intestine, Rectum
Rectal Spreader, acc. to Alan-Parks, without F.O. light carrier

Material: Stainless steel

Other Sizes:
018-0647-00 : 14 cm



Stomach, Intestine, Rectum
Sphincteroscope, acc. to Kelly, Ø 21 mm, working length

Material: Stainless steel

Other Sizes:
018-0649-01 : 50 mm
018-0649-02 : 50 mm

STOMACH, INTESTINE RECTUM



Stomach, Intestine, Rectum
Rubber rings for 018-0723-27, 100 pcs

Material: all other, not specially marked material types

Other Sizes:
018-0723-10 : 100 pcs



Stomach, Intestine, Rectum
Loading cone, for 0180-723-27

Material: Stainless steel

Other Sizes:
018-0723-26 : N/A



Stomach, Intestine, Rectum
Rubber rings for 018-0723-27, 100 pcs

Material: Stainless steel

Other Sizes:
018-0723-10 : 100 pcs



Stomach, Intestine, Rectum
Hemorrhoidal ligator, acc. to McGinvey

Material: Stainless steel

Other Sizes:
018-0724-19 : 19.5 cm



Stomach, Intestine, Rectum
Atraumatic rectal Biopsy forceps, jaw width

Material: Stainless steel

Other Sizes:
018-0741-38 : 15 mm , 38 cm



Stomach, Intestine, Rectum
N/A

Material: Stainless steel

Other Sizes:
018-0758-21 : 21 cm

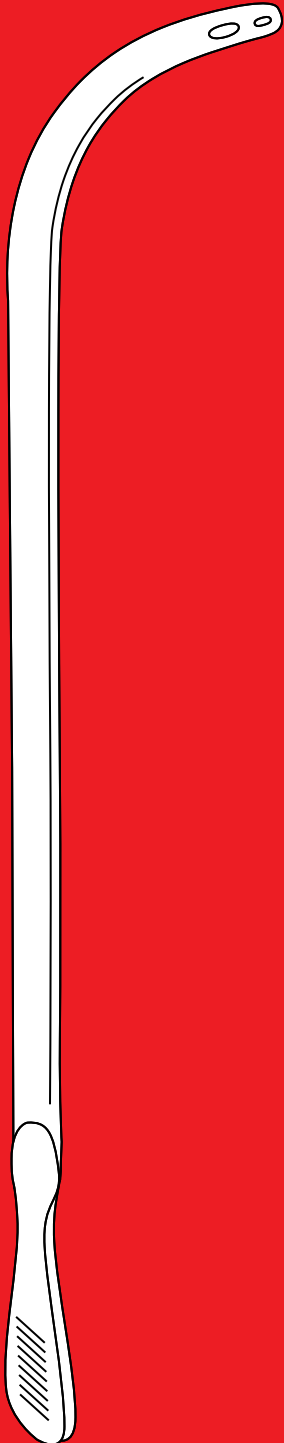

UROLOGY

— RANGE



DISCOVER NOW

“Instruments for
surgical procedures”
Since 1970



Urology
Kidney stone forceps, acc.
to Randall, no. 1

Material: Stainless steel

Other Sizes:
019-0101-23 : 23 cm



Urology
Kidney stone forceps, acc.
to Randall, no. 2

Material: Stainless steel

Other Sizes:
019-0103-22 : 21 cm



Urology
Kidney stone forceps, acc.
to Randall, no. 3

Material: Stainless steel

Other Sizes:
019-0105-22 : 19 cm



Urology
Kidney stone forceps, acc.
to Randall, no. 4

Material: Stainless steel

Other Sizes:
019-0107-22 : 18.5 cm



Urology
N/A

Material: Stainless steel

Other Sizes:
019-0109-19 : 19 cm



Urology
N/A

Material: Stainless steel

Other Sizes:
019-0111-19 : 19 cm





Urology
N/A

Material: Stainless steel

Other Sizes:
019-0112-23 : 23 cm



Urology
N/A

Material: Stainless steel

Other Sizes:
019-0112-24 : 24.5 cm



Urology
Kidney stone forceps, acc. to Heiming, for Children, no. 1

Material: Stainless steel

Other Sizes:
019-0113-16 : 16 cm



Urology
Kidney stone forceps, acc. to Heiming, for Children, no. 2

Material: Stainless steel

Other Sizes:
019-0113-17 : 17 cm



Urology
N/A

Material: Stainless steel

Other Sizes:
019-0115-01 : 21 cm
019-0115-02 : 21 cm



Urology
Gall duct dilator, acc. to Bakes

Material: steel 18/8 martinit, antimagnetic, stainless, acid-resistant

Other Sizes:
019-0170-01 : 1 mm, 32 cm
019-0170-02 : 2 mm, 32 cm
019-0170-03 : 3 mm, 32 cm
019-0170-04 : 4 mm, 32 cm



Urology
Gall duct dilator, acc. to Bakes

Material: steel 18/8 martinit,
antimagnetic, stainless, acid-resistant

Other Sizes:

019-0170-05	5 mm, 32 cm
019-0170-06	6 mm, 32 cm
019-0170-07	7 mm, 32 cm



Urology
Gall duct dilator, acc. to Bakes

Material: steel 18/8 martinit,
antimagnetic, stainless, acid-resistant

Other Sizes:

019-0170-08	8 mm, 32 cm
019-0170-09	9 mm, 32 cm
019-0170-10	10 mm, 32 cm



Urology
Gall duct dilator, acc. to Bakes

Material: steel 18/8 martinit,
antimagnetic, stainless, acid-resistant

Other Sizes:

019-0170-11	11 mm, 32 cm
019-0170-12	12 mm, 32 cm
019-0170-13	13 mm, 32 cm



Urology
Gallstone forceps, acc. to Blake,
straight

Material: Stainless steel

Other Sizes:

019-0204-20	21 cm
-------------	-------



Urology
Gallstone forceps, acc. to Blake,
curved

Material: Stainless steel

Other Sizes:

019-0205-20	21 cm
-------------	-------



Urology
Gallstone forceps, acc. to Mayo-
Blake, straight

Material: Stainless steel

Other Sizes:

019-0214-20	21 cm
-------------	-------



Urology
Gallstone forceps, acc. to Mayo-Blake, curved

Material: Stainless steel

Other Sizes:
019-0215-20 : 21 cm



Urology
Gallstone forceps, acc. to Mixer, curved

Material: Stainless steel

Other Sizes:
019-0217-22 : 21.5 cm



Urology
Gallstone forceps, acc. to Desjardins, no. 1

Material: Stainless steel

Other Sizes:
019-0223-23 : 23 cm



Urology
Gallstone forceps, acc. to Desjardins, no. 2

Material: Stainless steel

Other Sizes:
019-0225-23 : 23 cm



Urology
Gallstone forceps, acc. to Desjardins

Material: Stainless steel

Other Sizes:
019-0226-25 : N/A
019-0226-24 : N/A



Urology
Gallstone scoop

Material: Stainless steel

Other Sizes:
019-0340-01 : 2.7 mm, 32 cm
019-0340-02 : 3.4 mm, 32 cm
019-0340-03 : 4.3 mm, 32 cm
019-0340-04 : 5.5 mm, 32 cm



Urology
Gallstone scoop

Material: Stainless steel

Other Sizes:

019-0340-05	6.6 mm, 32 cm
019-0340-06	8 mm, 32 cm
019-0340-07	11 mm, 32 cm
019-0340-08	15 mm, 32 cm

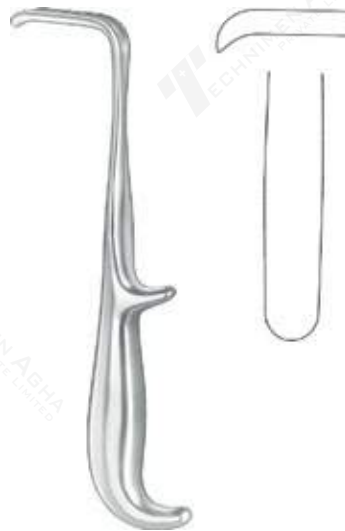

Urology
Prostatic retractor, acc. to Young, slim

Material: Stainless steel

Other Sizes:

019-0401-21	21.5 cm
-------------	---------



Urology
N/A

Material: Stainless steel

Other Sizes:

019-0403-22	20.5 cm
-------------	---------



Urology
Prostatic retractor, acc. to Young, bulbous

Material: Stainless steel

Other Sizes:

019-0405-21	22 cm
-------------	-------



Urology
Prostatic retractor, acc. to Young, forked

Material: Stainless steel

Other Sizes:

019-0407-22	23 cm
-------------	-------



Urology
31-451-24-07

Material: Stainless steel

Other Sizes:

019-0451-24	24.5 cm
-------------	---------



Urology
Capsule forceps, acc. to Millin

Material: Stainless steel

Other Sizes:
019-0461-23 : 24.5 cm



Urology
Capsule forceps, acc. to Millin,
9 x 10 teeth

Material: Stainless steel

Other Sizes:
019-0463-23 : 22 cm



Urology
Ligature carrying forceps, acc.
to Millin

Material: Stainless steel

Other Sizes:
019-0465-24 : 24.5 cm



Urology
Bladderneck spreader, acc. to
Millin, spreading width 70 mm

Material: Stainless steel

Other Sizes:
019-0479-00 : 29.5 cm



Urology
Bladder retractor, acc. to Judd-
Mason, spreading width 120 mm

Material: Stainless steel

Other Sizes:
019-0510-00 : 120 mm



Urology
Bladder retractor, acc. to Millin,
complete

Material: octagonal handle

Other Sizes:
019-0512-00 : N/A



Urology

Urethral sounds, acc. to V. Buren,
8-36 Ch, complete set

Material: Stainless steel

Other Sizes:

019-0599-00	27 cm
019-0599-08	27 cm
019-0599-10	27 cm
019-0599-12	27 cm
019-0599-14	27 cm
019-0599-16	27 cm
019-0599-18	27 cm
019-0599-20	27 cm
019-0599-22	27 cm
019-0599-24	27 cm
019-0599-26	27 cm
019-0599-28	27 cm
019-0599-30	27 cm
019-0599-32	27 cm
019-0599-34	27 cm
019-0599-36	27 cm



Urology

Urethral sounds, acc. to Guyon

Material: Stainless steel

Other Sizes:

019-0607-11	26.5 cm
019-0607-12	26.5 cm
019-0607-13	26.5 cm
019-0607-14	26.5 cm
019-0607-15	26.5 cm
019-0607-16	26.5 cm
019-0607-17	26.5 cm
019-0607-18	26.5 cm
019-0607-19	26.5 cm
019-0607-20	26.5 cm
019-0607-21	26.5 cm
019-0607-22	26.5 cm
019-0607-23	26.5 cm
019-0607-24	26.5 cm
019-0607-25	26.5 cm
019-0607-26	26.5 cm
019-0607-27	26.5 cm
019-0607-28	26.5 cm
019-0607-29	26.5 cm
019-0607-30	26.5 cm



Urology

Urethral sounds, acc. to Guyon

Material: Stainless steel

Other Sizes:

019-0607-10	26.5 cm
-------------	---------



Urology

Catheter for women, curved

Material: Stainless steel

Other Sizes:

019-0721-12	13 Ch, 15 cm
019-0721-14	15 Ch, 15 cm



Urology

Urethrotome, acc. to Otis, in case, complete set

Material: Stainless steel

Other Sizes:

019-0740-00	N/A
-------------	-----



Urology

Tips for 019-0740-00, 3 pcs.

Material: Replacement part

Other Sizes:

019-0740-90	3 pcs
-------------	-------



Urology

Spare blade for 019-0740-00

Material: Stainless steel

Other Sizes:

019-0745-00	N/A
-------------	-----



Urology

Urethrography instrument, acc. to Knutson

Material: Stainless steel

Other Sizes:

019-0760-00	N/A
-------------	-----



Urology

Cone, only, acc. to Knutson-Koch for 019-0760-00

Material: Stainless steel

Other Sizes:

019-0763-00	N/A
-------------	-----



Urology
Circumcision instrument

Material: Stainless steel

Other Sizes:

019-0765-08	Ø 8 mm
019-0765-11	Ø 11 mm
019-0765-13	Ø 13 mm
019-0765-16	Ø 16 mm
019-0765-21	Ø 21 mm
019-0765-26	Ø 26 mm
019-0765-32	Ø 32 mm



Urology
Circumcision instrument, acc. to Mogen

Material: Stainless steel

Other Sizes:

019-0766-00	7.5 cm
-------------	--------



Urology
Foreign body forceps, acc. to Mathieu, shaft length

Material: Stainless steel

Other Sizes:

019-0811-20	200 mm, 20 cm
019-0811-28	300 mm, 20 cm

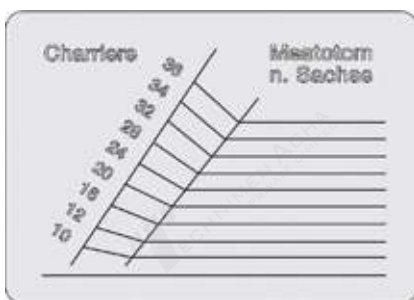

Urology
Gauge for 019-0817-12

Material: steel 18/8 martinit, antimagnetic, stainless, acid-resistant

Other Sizes:

019-0817-00	N/A
-------------	-----



Urology
Meatotome, acc. to Sachse, graduated in cm, shaft length 12 cm

Material: Stainless steel

Other Sizes:

019-0817-12	120 mm, 12 cm
-------------	---------------



Urology
Penis clamp, acc. to Stockmann

Material: steel 18/8 martinit, antimagnetic, stainless, acid-resistant

Other Sizes:

019-0875-08	8 cm
-------------	------



Urology

Penis clamp, with rubber coating

Material: steel 18/8 martinit,
antimagnetic, stainless, acid-resistant

Other Sizes:

019-0881-11 : 11 cm



Urology

Vaginal speculum, acc. to Jackson

Material: Stainless steel

Other Sizes:

020-0165-01 : 75 x 38 mm



Urology

Atraumatic capsule forceps, acc. to Millin

Material: Stainless steel

Other Sizes:

091-0453-24 : 22 cm

GYNECOLOGY

— RANGE

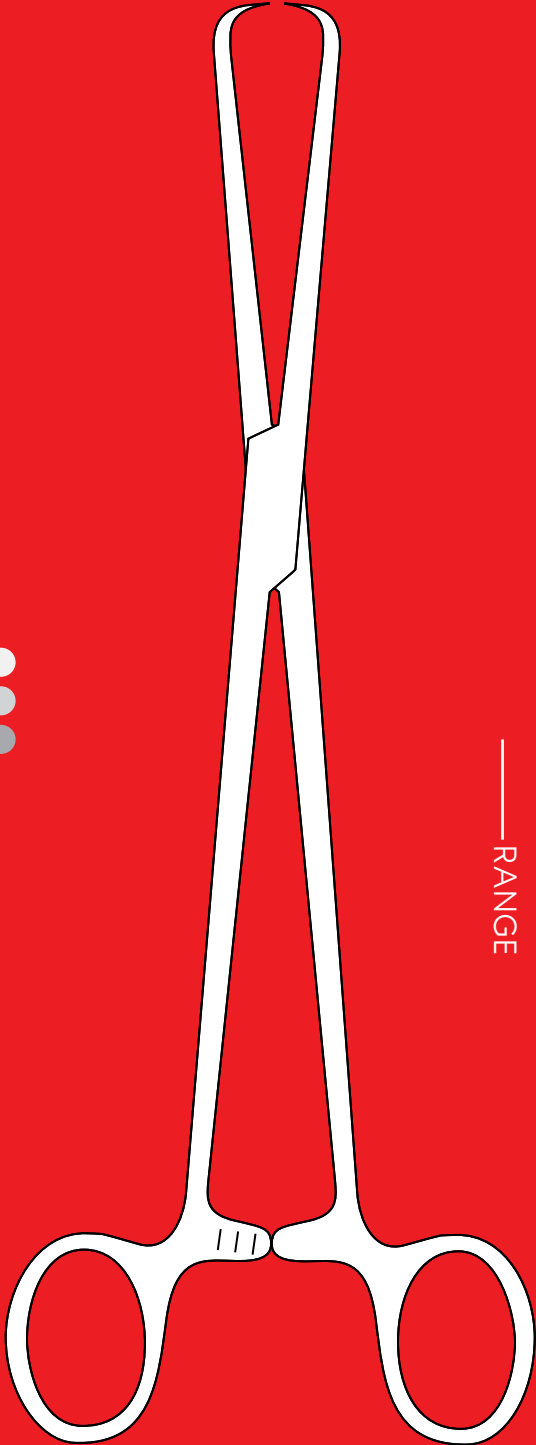

DISCOVER NOW

“Instruments for
surgical procedures”
Since 1970



Gynecology
Vaginal speculum, acc. to Cusco

Material: steel 18/8 martinit,
antimagnetic, stainless, acid-resistant

Other Sizes:

020-0110-01	75 x 32 mm
020-0110-02	85 x 35 mm
020-0110-03	100 x 35 mm



Gynecology
Vaginal speculum, acc. to Cusco

Material: steel 18/8 martinit,
antimagnetic, stainless, acid-resistant

Other Sizes:

020-0112-01	75 x 18 mm
-------------	------------



Gynecology
Vaginal speculum, acc. to Cusco

Material: steel 18/8 martinit,
antimagnetic, stainless, acid-resistant

Other Sizes:

020-0114-01	80 x 22 mm
020-0114-02	100 x 25 mm
020-0114-03	105 x 27 mm



Gynecology
Vaginal speculum, acc. to Cusco

Material: Stainless steel

Other Sizes:

020-0116-01	75 x 34 mm
020-0116-02	85 x 37 mm
020-0116-03	100 x 37 mm



Gynecology
Vaginal speculum, acc. to Grave

Material: Stainless steel

Other Sizes:

020-0130-01	75 x 20 mm
020-0130-02	95 x 35 mm
020-0130-03	115 x 35 mm



Gynecology
Vaginal speculum, acc. to Trelat

Material: steel 18/8 martinit,
antimagnetic, stainless, acid-resistant

Other Sizes:

020-0126-01	85 x 33 mm
020-0126-02	95 x 35 mm
020-0126-03	115 x 43 mm



Gynecology

Vaginal speculum, acc. to Pederson

Material: steel 18/8 martinit,
antimagnetic, stainless, acid-resistant

Other Sizes:

020-0128-01	75 x 13 mm
020-0128-02	100 x 22 mm
020-0128-03	120 x 25 mm



Gynecology

Vaginal speculum, acc. to Grave

Material: Stainless steel

Other Sizes:

020-0130-01	75 x 20 mm
020-0130-02	95 x 35 mm
020-0130-03	115 x 35 mm



Gynecology

Vaginal speculum, acc. to Semm

Material: steel 18/8 martinit,
antimagnetic, stainless, acid-resistant

Other Sizes:

020-0132-01	25 mm
020-0132-02	35 mm



Gynecology

Vaginal speculum, acc. to Guttman

Material: Stainless steel

Other Sizes:

020-0133-01	90 x 35 mm
-------------	------------



Gynecology

Vaginal speculum, acc. to Sims

Material: steel 18/8 martinit,
antimagnetic, stainless, acid-resistant

Other Sizes:

020-0160-01	65 x 25 mm / 70 x 30 mm
020-0160-02	70 x 30 mm / 70 x 35 mm
020-0160-03	85 x 35 mm / 90 x 40 mm



Gynecology

Vaginal speculum, acc. to Jackson

Material: Stainless steel

Other Sizes:

020-0165-01	75 x 38 mm
-------------	------------



Gynecology
Vaginal speculum, acc. to Kristeller, fig. 1

Material: steel 18/8 martinit,
antimagnetic, stainless, acid-resistant

Other Sizes:

020-0182-01	70 x 27 mm
020-0182-02	80 x 30 mm
020-0182-03	90 x 36 mm



Gynecology
Vaginal retractor, acc. to Kristeller

Material: steel 18/8 martinit,
antimagnetic, stainless, acid-resistant

Other Sizes:

020-0183-01	75 x 23 mm
020-0183-02	85 x 26 mm
020-0183-03	100 x 32 mm



Gynecology
Vaginal speculum, acc. to Kristeller

Material: Stainless steel

Other Sizes:

020-0185-01	N/A
020-0185-02	N/A
020-0185-03	N/A



Gynecology
Vaginal speculum, acc. to Kristeller

Material: steel 18/8 martinit,
antimagnetic, stainless, acid-resistant

Other Sizes:

020-0190-01	105 x 18 mm
020-0190-02	105 x 21 mm



Gynecology
Vaginal retractor, acc. to Kristeller

Material: Stainless steel

Other Sizes:

020-0191-01	110 x 14 mm
020-0191-02	110 x 17 mm



Gynecology
Vaginal speculum, acc. to Kristeller, set

Material: Stainless steel

Other Sizes:

020-0195-01	N/A
020-0195-02	N/A



Gynecology
Vaginal speculum, acc. to Kristeller

Material: steel 18/8 martinit,
antimagnetic, stainless, acid-resistant

Other Sizes:

020-0196-01	105 x 26 mm
020-0196-02	105 x 28 mm
020-0196-03	105 x 33 mm



Gynecology
Vaginal retractor, acc. to Kristeller

Material: steel 18/8 martinit,
antimagnetic, stainless, acid-resistant

Other Sizes:

020-0197-01	115 x 22 mm
020-0197-02	115 x 24 mm
020-0197-03	115 x 29 mm



Gynecology
Vaginal speculum, acc. to Kristeller, set

Material: steel 18/8 martinit,
antimagnetic, stainless, acid-resistant

Other Sizes:

020-0199-01	N/A
020-0199-02	N/A
020-0199-03	N/A



Gynecology
Vaginal speculum, acc. to Kristeller

Material: steel 18/8 martinit,
antimagnetic, stainless, acid-resistant

Other Sizes:

020-0202-01	110 x 27 mm
020-0202-02	110 x 30 mm
020-0202-03	110 x 36 mm



Gynecology
Vaginal retractor, acc. to Kristeller

Material: steel 18/8 martinit,
antimagnetic, stainless, acid-resistant

Other Sizes:

020-0203-01	115 x 23 mm
020-0203-02	115 x 26 mm
020-0203-03	115 x 32 mm



Gynecology
Vaginal speculum, acc. to Kristeller

Material: steel 18/8 martinit,
antimagnetic, stainless, acid-resistant

Other Sizes:

020-0205-01	N/A
020-0205-02	N/A
020-0205-03	N/A



Gynecology

Vaginal speculum, acc. to Kallmorgen

Material: steel 18/8 martinit,
antimagnetic, stainless, acid-resistant

Other Sizes:

020-0232-01	70 x 40 mm
020-0232-02	90 x 40 mm



Gynecology

Vaginal retractor, acc. to Kallmorgen

Material: steel 18/8 martinit,
antimagnetic, stainless, acid-resistant

Other Sizes:

020-0233-01	70 x 33 mm
020-0233-02	90 x 33 mm



Gynecology

Vaginal speculum, acc. to Kallmorgen

Material: steel 18/8 martinit,
antimagnetic, stainless, acid-resistant

Other Sizes:

020-0235-01	N/A
020-0235-02	N/A



Gynecology

Vaginal speculum, acc. to Doyen

Material: steel 18/8 martinit,
antimagnetic, stainless, acid-resistant

Other Sizes:

020-0249-01	63 x 35 mm
020-0249-02	94 x 35 mm
020-0249-03	124 x 35 mm



Gynecology

Vaginal speculum, acc. to Doyen

Material: steel 18/8 martinit,
antimagnetic, stainless, acid-resistant

Other Sizes:

020-0250-01	66 x 47 mm
020-0250-02	95 x 47 mm
020-0250-03	126 x 47 mm
020-0250-04	160 x 47 mm



Gynecology

Vaginal speculum, acc. to Doyen

Material: steel 18/8 martinit,
antimagnetic, stainless, acid-resistant

Other Sizes:

020-0251-01	55 x 60 mm
020-0251-02	95 x 60 mm
020-0251-03	130 x 60 mm
020-0251-04	175 x 60 mm



Gynecology
Retractor blade, acc. to Scherbak

Material: steel 18/8 martinit,
antimagnetic, stainless, acid-resistant

Other Sizes:
020-0302-01 80 x 30 mm
020-0302-02 80 x 35 mm
020-0302-03 90 x 40 mm



Gynecology
Retractor blade, acc. to Scherbak

Material: steel 18/8 martinit,
antimagnetic, stainless, acid-resistant

Other Sizes:
020-0302-04 62 x 40-60 mm



Gynecology
Retractor blade, acc. to Scherbak

Material: steel 18/8 martinit,
antimagnetic, stainless, acid-resistant

Other Sizes:
020-0302-05 81 x 45-70 mm



Gynecology
Weight only, acc. to Scherbak, 400 g,
for 020-0302-00

Material: steel 18/8 martinit,
antimagnetic, stainless, acid-resistant

Other Sizes:
020-0302-10 10.5 cm



Gynecology
Weight only, acc. to Scherbak, 800 g,
for 020-0302-00

Material: steel 18/8 martinit,
antimagnetic, stainless, acid-resistant

Other Sizes:
020-0302-12 13 cm



Gynecology
Handle only, acc. to Scherbak,
for 020-0302-00

Material: octagonal handle

Other Sizes:
020-0302-14 20 cm



Gynecology
Vaginal speculum, acc. to Auvard

Material: steel 18/8 martinit, antimagnetic, stainless, acid-resistant

Other Sizes:
020-0310-22 : 80 x 43 mm

Gynecology
Vaginal speculum, acc. to Weissbarth

Material: chrome-plated

Other Sizes:
020-0314-24 : 80 x 42 mm, 21 cm

Gynecology
Strainer only, for 020-0314-24

Material: chrome-plated

Other Sizes:
020-0314-99 : N/A



Gynecology
Vaginal retractor, acc. to Breisky

Material: Stainless steel

Other Sizes:
020-0323-20 : 100 x 20 mm
020-0323-25 : 100 x 25 mm
020-0323-30 : 100 x 30 mm
020-0323-35 : 100 x 35 mm
020-0323-40 : 100 x 40 mm

Gynecology
Vaginal retractor, acc. to Breisky

Material: Stainless steel

Other Sizes:
020-0324-20 : 130 x 20 mm
020-0324-25 : 130 x 25 mm
020-0324-30 : 130 x 30 mm
020-0324-35 : 130 x 35 mm
020-0324-40 : 130 x 40 mm

Gynecology
Vaginal retractor, acc. to Doyen

Material: steel 18/8 martinit, antimagnetic, stainless, acid-resistant

Other Sizes:
020-0342-24 : 25 cm



Gynecology
Endo speculum, acc. to Kogan

Material: Stainless steel

Other Sizes:
020-0381-24 : 24.5 cm



Gynecology
Endo speculum, acc. to Kogan, with lock

Material: Stainless steel

Other Sizes:
020-0383-24 : 24.5 cm



Gynecology
Uterine dilator, acc. to Goodell

Material: steel 18/8 martinit, antimagnetic, stainless, acid-resistant

Other Sizes:
014-0084-01 : 17 cm, 9mm



Gynecology
Uterine dilator, acc. to Hegar, set of 14 pcs

Material: steel 18/8 martinit, antimagnetic, stainless, acid-resistant

Other Sizes:
020-0400-80 : 4-7 mm



Gynecology
Uterine dilator, acc. to Hegar, set of 14 pcs

Material: steel 18/8 martinit, antimagnetic, stainless, acid-resistant

Other Sizes:
020-0400-84 : 4-17 mm



Gynecology
Uterine dilator, acc. to Hegar, set of 26 pcs

Material: steel 18/8 martinit, antimagnetic, stainless, acid-resistant

Other Sizes:
020-0400-90 : 1-26 mm



Gynecology

Uterine dilator, acc. to Hegar, double, set of 8 pcs

Material: steel 18/8 martinit, antimagnetic, stainless, acid-resistant

Other Sizes:
020-0430-82 : 3.0/4.0-17.0/18.0 mm



Gynecology

Uterine dilator, acc. to Hank, double, set of 6 pcs., in canvas roll

Material: steel 18/8 martinit, antimagnetic, stainless, acid-resistant

Other Sizes:
020-0460-82 : N/A



Gynecology

Uterine dilator, acc. to Hegar, double, set of 8 pcs, in metal case

Material: steel 18/8 martinit, antimagnetic, stainless, acid-resistant

Other Sizes:
020-0430-84 : 3.0/4.0 -17.0/18.0 mm



Gynecology

Uterine dilator, acc. to Hank, double

Material: steel 18/8 martinit, antimagnetic, stainless, acid-resistant

Other Sizes:
020-0460-10 : 4.5/5 mm
020-0460-12 : 5.5/6 mm
020-0460-14 : 6.5/7 mm
020-0460-16 : 7.5/8 mm
020-0460-18 : 8.5/9 mm
020-0460-20 : 9.5/10 mm



Gynecology

Uterine probe, acc. to Sims, rigid

Material: Stainless steel

Other Sizes:
020-0583-32 : 33 cm



Gynecology
Uterine probe, acc. to Sims, malleable

Material: chrome-plated

Other Sizes:
020-0584-32 : 33 cm



Gynecology
Uterine probe, acc. to Valleix

Material: steel 18/8 martinit,
antimagnetic, stainless, acid-resistant

Other Sizes:
020-0593-25 : 29.5 cm



Gynecology
Uterine depressor, acc. to Braun

Material: Stainless steel

Other Sizes:
020-0595-26 : 27.5 cm



Gynecology
Uterine tenaculum forceps, acc.
to Schröder, 1 x 1 teeth

Material: Stainless steel

Other Sizes:
020-0622-25 : 25.5 cm



Gynecology
Uterine tenaculum forceps, acc.
to Braun, 1 x 1 teeth

Material: Stainless steel

Other Sizes:
020-0628-25 : 26 cm



Gynecology
Uterine tenaculum forceps, acc.
to Duplay, s-sharp

Material: Stainless steel

Other Sizes:
020-0645-28 : 25.5 cm



Gynecology

Amniotome, acc. to Beacham

Material: Stainless steel

Other Sizes:

020-0659-26 : 26 cm



Gynecology

Uterine tenaculum forceps, acc. to Skene, 1 x 1 teeth, curved

Material: Stainless steel

Other Sizes:

020-0663-24 : 24 cm



Gynecology

Uterine tenaculum forceps, acc. to Schröder, straight, 2 x 2 teeth

Material: Stainless steel

Other Sizes:

020-0682-24 : 25 cm

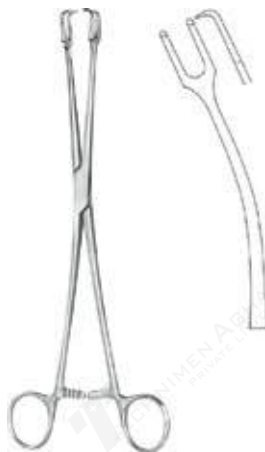

Gynecology

Uterine tenaculum forceps, acc. to Schröder, curved, 2 x 2 teeth

Material: Stainless steel

Other Sizes:

020-0683-24 : 23.5 cm



Gynecology

Uterine tenaculum forceps, acc. to Teale, curved, 4 x 5 teeth

Material: Stainless steel

Other Sizes:

020-0697-23 : 23 cm



Gynecology

Uterine tenaculum forceps, acc. to Iowá, 5 x 6 teeth, curved

Material: Stainless steel

Other Sizes:

020-0699-26 : 26 cm



Gynecology
Uterine tenaculum forceps, acc. to Museux, 7 mm, 2 x 2 teeth

Material: Stainless steel

Other Sizes:
020-0702-24 : 24 cm



Gynecology
Uterine tenaculum forceps, acc. to Museux, 9 mm, 2 x 2 teeth

Material: Stainless steel

Other Sizes:
020-0704-24 : 24 cm



Gynecology
Uterine tenaculum forceps, acc. to Museux, 10mm, 2 x 2 teeth

Material: Stainless steel

Other Sizes:
020-0706-24 : 24 cm



Gynecology
Uterine tenaculum forceps, acc. to Jacobs, straight, 2 x 2 teeth,

Material: Stainless steel

Other Sizes:
020-0728-21 : 21 cm

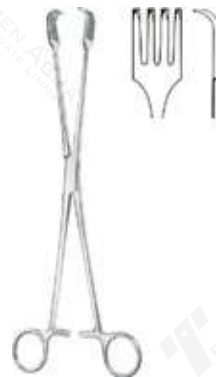

Gynecology
Uterine tenaculum forceps, 4 x 4 teeth

Material: Stainless steel

Other Sizes:
020-0734-26 : 26.5 cm



Gynecology
Uterine tenaculum forceps, acc. to Braun, 4 x 4 teeth

Material: Stainless steel

Other Sizes:
020-0738-16 : 16 cm



Gynecology

Uterine tenaculum forceps, acc. to Czerny, 4 x 4 teeth

Material: Stainless steel

Other Sizes:
020-0740-21 : 21 cm



Gynecology

Uterine polypus forceps, acc. to Kelly

Material: Stainless steel

Other Sizes:
020-0741-32 : 32 cm



Gynecology

Uterine polypus forceps, acc. to Noto

Material: Stainless steel

Other Sizes:
020-0744-27 : 27 cm



Gynecology

Uterine polypus forceps, acc. to Heywood-Smith

Material: Stainless steel

Other Sizes:
020-0745-25 : 25 cm



Gynecology

Myoma screw, acc. to Doyen, Ø 14 mm

Material: Stainless steel

Other Sizes:
020-0757-17 : 17 cm



Gynecology

Myoma screw, acc. to Doyen, Ø 25 mm

Material: Stainless steel

Other Sizes:
020-0759-17 : 14.5 cm



Gynecology
Myoma knife, acc. to Segond

Material: Stainless steel

Other Sizes:
020-0762-27 28 cm



Gynecology
Uterine seizing forceps, acc. to Dartigues

Material: Stainless steel

Other Sizes:
020-0773-27 28 cm



Gynecology
Uterine seizing forceps, acc. to Somer, curved

Material: Stainless steel

Other Sizes:
020-0779-23 22.5 cm



Gynecology
Uterine seizing forceps, acc. to Collin

Material: Stainless steel

Other Sizes:
020-0793-25 26 cm

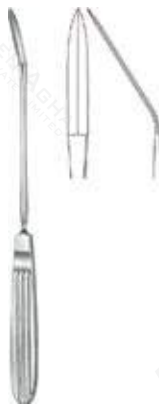

Gynecology
Conization knife, acc. to Ayre, angled

Material: Stainless steel

Other Sizes:
020-0801-23 23.5 cm



Gynecology
Fistula hook, acc. to Emmett, no. 3, angled

Material: octagonal handle

Other Sizes:
020-0804-03 22 cm



Gynecology
Fistula hook, acc. to Simon, 1 prong

Material: Stainless steel

Other Sizes:
020-0806-22 : 21.5 cm



Gynecology
Fistula hook, acc. to Simon, 2 prongs

Material: Stainless steel

Other Sizes:
020-0808-22 : 21.5 cm



Gynecology
Suction curette, acc. to Novak,
Ø 4 mm , with Luer-Lock connection

Material: steel 18/8 martinit,
antimagnetic, stainless, acid-resistant

Other Sizes:
020-0825-23 : 24.5 cm



Gynecology
Uterine biopsy curette, acc. to Kevorkian

Material: Stainless steel

Other Sizes:
020-0827-30 : 30 cm



Gynecology
Biopsy curette, Munich-type

Material: Stainless steel

Other Sizes:
020-0829-27 : 27 cm



Gynecology
Uterine biopsy forceps, acc. to Gellhorn

Material: Stainless steel

Other Sizes:
020-0841-23 : 24 cm



Gynecology
Uterine biopsy forceps, acc. to Faure

Material: Stainless steel

Other Sizes:
020-0843-21 : 21 cm



Gynecology
Uterine biopsy forceps, acc. to Schubert

Material: Stainless steel

Other Sizes:
020-0846-21 : 21.5 cm
020-0846-28 : 28 cm



Gynecology
Uterine biopsy forceps, acc. to Thoms-Gaylor

Material: Stainless steel

Other Sizes:
020-0851-22 : 21 cm
020-0851-24 : 23.5 cm



Gynecology
Uterine biopsy forceps, acc. to Schubert

Material: Stainless steel

Other Sizes:
020-0853-26 : 25.5 cm



Gynecology
Uterine biopsy forceps, acc. to Van Doren

Material: Stainless steel

Other Sizes:
020-0855-24 : 27 cm



Gynecology
Uterine biopsy forceps, acc. to Van Doren

Material: Stainless steel

Other Sizes:
020-0855-25 : 25.5 cm



Gynecology

Uterine biopsy forceps, acc. to Alexander, jaw 5.1 mm wide

Material: Stainless steel

Other Sizes:

020-0857-28 : 28 cm



Gynecology

Uterine biopsy forceps, acc. to Kevorkian

Material: Stainless steel

Other Sizes:

020-0859-32 : 25 cm



Gynecology

Uterine biopsy forceps, acc. to Schumacher, shaft length 22.5 cm

Material: Stainless steel

Other Sizes:

020-0861-01 : 24 cm
020-0861-02 : 24 cm



Gynecology

Uterine biopsy forceps, acc. to Schumacher, set

Material: Stainless steel

Other Sizes:

020-0865-00 : N/A
020-0865-01 : N/A



Gynecology

IUP grasping forceps, flexible

Material: Stainless steel

Other Sizes:

020-0866-22 : Ø 3.0 mm, 27 cm
020-0866-28 : Ø 3.0 mm, 32 cm



Gynecology

Uterine scoop, acc. to Simon,

Material: Stainless steel

Other Sizes:

020-0900-01 : 24.5 cm
020-0900-02 : 24.5 cm
020-0900-03 : 24.5 cm
020-0900-04 : 24.5 cm
020-0900-05 : 25 cm
020-0900-06 : 25 cm



Gynecology

Uterine scoop, acc. to Simon

Material: Stainless steel

Other Sizes:

020-0906-01	30 cm
020-0906-02	30 cm
020-0906-03	31 cm
020-0906-04	31 cm
020-0906-05	31 cm
020-0906-06	31 cm



Gynecology

Uterine curette, acc. to Recamier, sharp, rigid

Material: Stainless steel

Other Sizes:

020-0920-05	5 mm
020-0920-06	6 mm
020-0920-07	7 mm
020-0920-08	8 mm
020-0920-09	9 mm
020-0920-11	11 mm
020-0920-12	12 mm
020-0920-14	14 mm
020-0920-15	15 mm
020-0920-16	16 mm
020-0920-19	19 mm
020-0920-20	20 mm
020-0920-21	21 mm
020-0920-23	23 mm
020-0920-25	25 mm
020-0920-30	30 mm
020-0920-35	35 mm
020-0920-40	40 mm



Gynecology

Uterine curette, acc. to Recamier, sharp, malleable

Material: Stainless steel

Other Sizes:

020-0921-05	5 mm
020-0921-06	6 mm
020-0921-07	7 mm
020-0921-08	8 mm
020-0921-09	9 mm
020-0921-11	11 mm
020-0921-12	12 mm
020-0921-14	14 mm
020-0921-15	15 mm
020-0921-16	16 mm
020-0921-19	19 mm
020-0921-20	20 mm
020-0921-21	21 mm
020-0921-23	23 mm
020-0921-25	25 mm
020-0921-30	30 mm
020-0921-35	35 mm
020-0921-40	40 mm



Gynecology

Curette, double, acc. to Blake, sharp/blunt, 8/13 mm

Material: Stainless steel

Other Sizes:

020-0919-00 : 27.5 cm



Gynecology

Uterine curette, acc. to Sims, blunt, rigid

Material: Stainless steel

Other Sizes:

020-0926-05	5 mm
020-0926-06	6 mm
020-0926-07	7 mm
020-0926-08	8 mm
020-0926-09	9 mm
020-0926-11	11 mm
020-0926-12	12 mm
020-0926-14	14 mm
020-0926-15	15 mm
020-0926-16	16 mm
020-0926-19	19 mm
020-0926-20	20 mm
020-0926-21	21 mm
020-0926-23	23 mm
020-0926-25	25 mm
020-0926-30	30 mm
020-0926-35	35 mm
020-0926-40	40 mm



Gynecology

Uterine curette, acc. to Sims, blunt, malleable

Material: Stainless steel

Other Sizes:

020-0927-05	5 mm
020-0927-06	6 mm
020-0927-07	7 mm
020-0927-08	8 mm
020-0927-09	9 mm
020-0927-11	11 mm
020-0927-12	12 mm
020-0927-14	14 mm
020-0927-15	15 mm
020-0927-16	16 mm
020-0927-19	19 mm
020-0927-20	20 mm
020-0927-21	21 mm
020-0927-23	23 mm
020-0927-25	25 mm
020-0927-30	30 mm
020-0927-35	35 mm
020-0927-40	40 mm



Gynecology
Uterine curette, acc. to Greene

Material: Stainless steel

Other Sizes:

020-0924-10	10 mm, 28 cm
020-0924-12	12 mm, 28 cm
020-0924-14	14 mm, 28 cm



Gynecology
Aspirating curette

Material: steel 18/8 martinit,
antimagnetic, stainless, acid-resistant

Other Sizes:

020-0989-08	Ø 08 mm, 29 cm
020-0989-10	Ø 10 mm, 29 cm
020-0989-12	Ø 12 mm, 29 cm
020-0989-14	Ø 14 mm, 29 cm



Gynecology
Coupling piece, angled

Material: steel 18/8 martinit,
antimagnetic, stainless, acid-resistant

Other Sizes:

020-0989-50	11 cm
-------------	-------



Gynecology
Salpingograph, acc. to Schultze,
set, in wooden case

Material: chrome-plated

Other Sizes:

020-0995-00	29.5 cm
-------------	---------



Gynecology
Salpingograph, acc. to Schultze,
29.5 cm, without manometer

Material: chrome-plated

Other Sizes:

020-0995-01	N/A
-------------	-----



Gynecology
Manometer, for 020-0995-00

Material: Stainless steel

Other Sizes:

020-0995-02	N/A
-------------	-----

OBSTETRICS

— RANGE

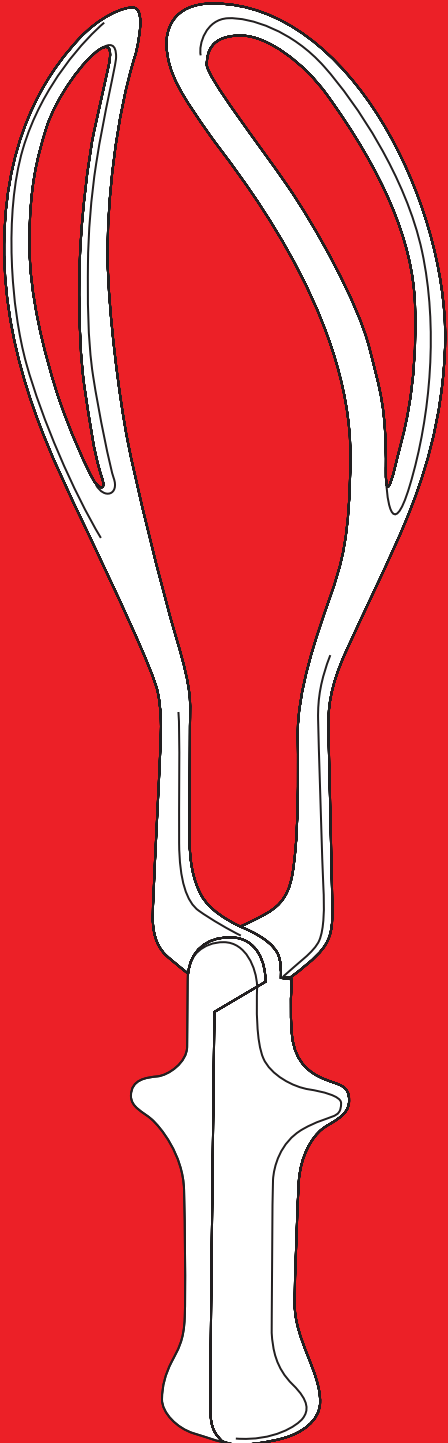

DISCOVER NOW

“Instruments for
surgical procedures”
Since 1970



Obstetrics
Pelvimeter, acc. to Martin, inches and cm

Material: Stainless steel

Other Sizes:
021-0103-34 : 34 cm



Obstetrics
Obstetrical forceps, acc. to Naegele

Material: Stainless steel

Other Sizes:
021-0141-36 : 35 cm
021-0141-40 : 40.5 cm



Obstetrics
Obstetrical forceps, acc. to Simpson

Material: Stainless steel

Other Sizes:
021-0145-30 : 31 cm



Obstetrics
Obstetrical forceps, acc. to Wrigley

Material: Stainless steel

Other Sizes:
021-0146-28 : 28 cm



Obstetrics
Obstetrical forceps, acc. to Simpson

Material: Stainless steel

Other Sizes:
021-0149-36 : 36.5 cm



Obstetrics
Obstetrical forceps, acc. to Kielland

Material: Stainless steel

Other Sizes:
021-0195-41 : 42 cm



Obstetrics

Obstetrical forceps, acc. to Kielland-Luikart

Material: Stainless steel

Other Sizes:

021-0197-40 : 40 mm



Obstetrics

Obstetrical forceps, acc. to Piper

Material: Stainless steel

Other Sizes:

021-0198-44 : 44.5 cm



Obstetrics

Haemosthetic forceps, acc. to Green-Armytage

Material: Stainless steel

Other Sizes:

021-0300-21 : 21 cm



Obstetrics

N/A

Material: Stainless steel

Other Sizes:

021-0309-28 : 32 cm

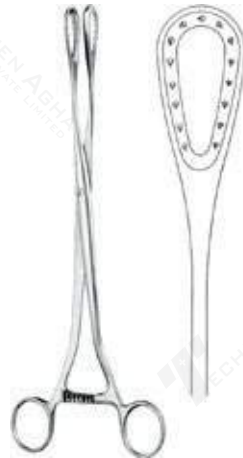

Obstetrics

Ovum forceps, acc. to Saenger, straight

Material: Stainless steel

Other Sizes:

021-0328-27 : 27.5 cm



Obstetrics

Ovum forceps, acc. to Saenger, curved

Material: Stainless steel

Other Sizes:

021-0329-27 : 27 cm



Obstetrics
Ovum forceps, acc. to Winter, straight, N. 1

Material: Stainless steel

Other Sizes:
021-0344-01 : 28 cm



Obstetrics
Ovum forceps, acc. to Winter, straight, N. 2

Material: Stainless steel

Other Sizes:
021-0344-02 : 28 cm



Obstetrics
Ovum forceps, acc. to Winter, curved, N. 1

Material: Stainless steel

Other Sizes:
021-0345-01 : 28 cm



Obstetrics
Ovum curette, acc. to Pestalozza

Material: Stainless steel

Other Sizes:
021-0386-30 : 30 cm



Obstetrics
Ovum forceps, acc. to Winter, curved, N. 2

Material: Stainless steel

Other Sizes:
021-0345-02 : 28 cm



Obstetrics
Ovum curette, acc. to Cuzzi

Material: Stainless steel

Other Sizes:
021-0382-01 : 17 mm, 30 cm
021-0382-02 : 20 mm, 30 cm
021-0382-03 : 23 mm, 30 cm



Obstetrics
Umbilical cord clamp, acc. to Collin

Material: Stainless steel

Other Sizes:
021-0465-09 : 8.5 cm

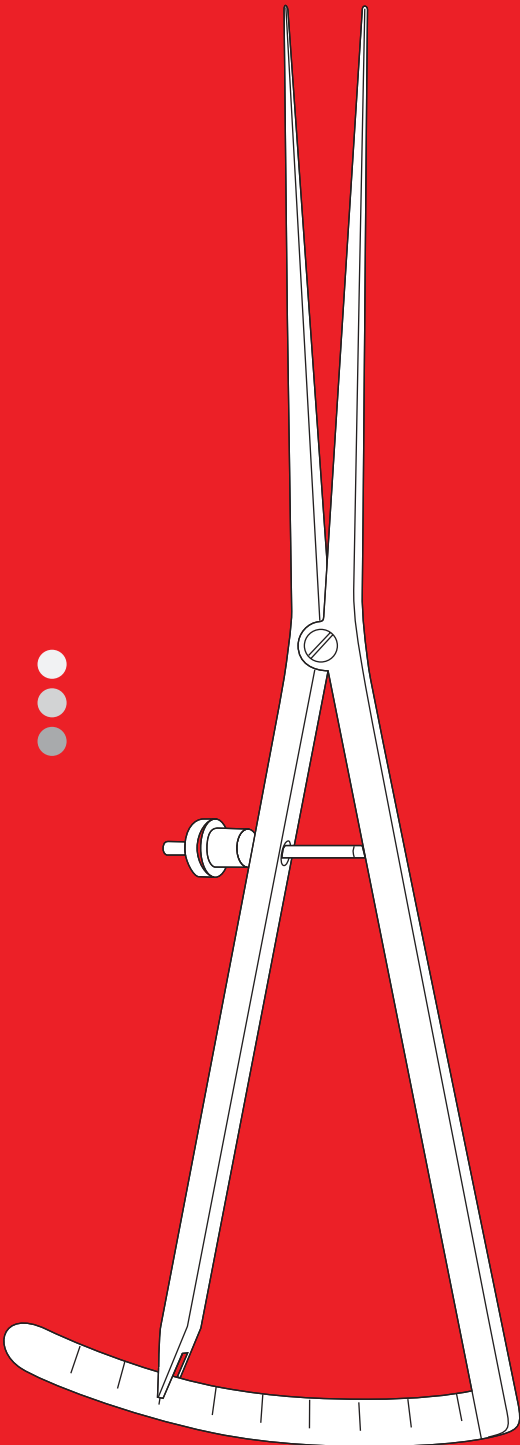

GALIPPERS

— RANGE

DISCOVER NOW

“Instruments for
surgical procedures”
Since 1970

CALIPERS



Calipers
Caliper, Castroviejo, 0-15 mm

Material: Stainless steel

Other Sizes:
022-0133-06 : 8 cm



Calipers
Caliper, Castroviejo, straight, 0-20 mm

Material: Stainless steel

Other Sizes:
022-0133-07 : 8 cm



Calipers
Caliper, Castroviejo-Schachar, curved, 0-20 mm

Material: Stainless steel

Other Sizes:
022-0133-09 : 8 cm



Calipers
Caliper, Castroviejo-Epker, 0-40 mm

Material: Stainless steel

Other Sizes:
022-0134-09 : 9 cm



Calipers
Caliper, Castroviejo-Epker, 0-40 mm

Material: Stainless steel

Other Sizes:
022-0134-18 : 18 cm



Calipers
Caliper, Castroviejo-Epker, 0-40 mm

Material: Stainless steel

Other Sizes:
022-0135-18 : 18 cm

CALIPERS



Calipers

Probe, acc. to Bowman, button-ended/cylindrical, Sterling Silver

Material: Silver

Other Sizes:

022-0220-00	13 cm
022-0220-11	13 cm
022-0220-22	13 cm
022-0220-33	13 cm
022-0220-44	13 cm
022-0220-55	13 cm
022-0220-66	13 cm
022-0220-77	13 cm
022-0220-88	13 cm



Calipers

Probe, acc. to Bowman, cylindrical, Sterling Silver

Material: Silver

Other Sizes:

022-0224-99	13 cm
022-0224-00	13 cm
022-0224-01	13 cm
022-0224-12	13 cm
022-0224-23	13 cm
022-0224-34	13 cm
022-0224-45	13 cm
022-0224-56	13 cm
022-0224-67	13 cm
022-0224-78	13 cm



Calipers

Probe, acc. to Bowman, button-ended, Sterling Silver

Material: Silver

Other Sizes:

022-0226-01	13 cm
022-0226-12	13 cm
022-0226-23	13 cm
022-0226-34	13 cm
022-0226-45	13 cm
022-0226-56	13 cm
022-0226-67	13 cm
022-0226-78	13 cm
022-0226-00	13 cm



Calipers

Trowel knife

Material: Stainless steel

Other Sizes:

022-0370-01	4 x 6 mm, 12 cm
022-0370-02	7 x 11 mm, 16 cm

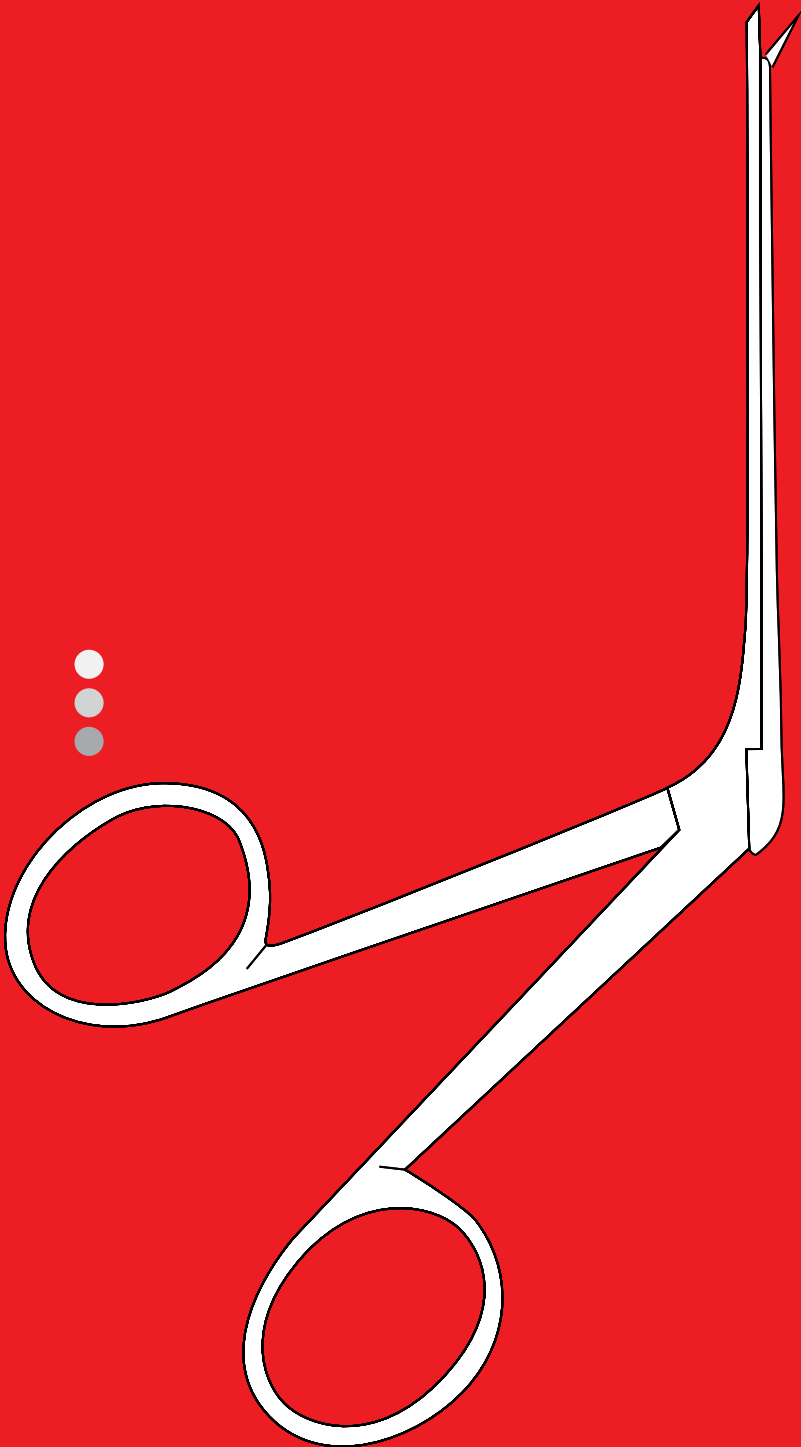

OTOLOGY

— RANGE

DISCOVER NOW

“Instruments for
surgical procedures”
Since 1970

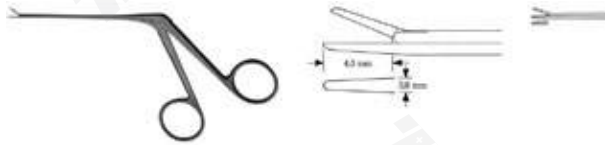

Otology

Micro ear forceps, straight

Material: Stainless steel

Other Sizes:

023-0001-01 : 4 x 0.8 mm



Otology

Micro ear forceps, straight

Material: Stainless steel

Other Sizes:

023-0001-06 : 4 x 0.8 mm



Otology

Micro ear forceps, curved upwards

Material: Stainless steel

Other Sizes:

023-0001-07 : 4 x 0.8 mm



Otology

Micro ear forceps, right

Material: Stainless steel

Other Sizes:

023-0001-08 : 4 x 0.8 mm

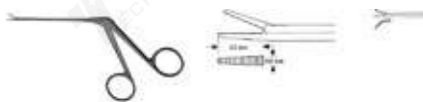

Otology

Micro ear forceps, left

Material: Stainless steel

Other Sizes:

023-0001-09 : 4 x 0.8 mm



Otology

Mini alligator forceps, acc. to McGee, smooth

Material: Stainless steel

Other Sizes:

023-0001-11 : 3.5 x 0.6 mm



Otology

Mini alligator forceps, acc. to McGee, serrated

Material: Stainless steel

Other Sizes:

023-0001-16 : 3.5 x 0.6 mm

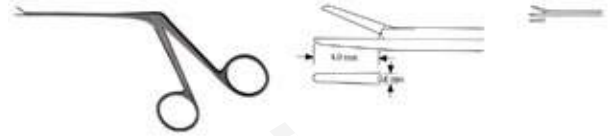

Otology

Micro ear forceps, straight

Material: Stainless steel

Other Sizes:

023-0001-21 : 4 x 0.6 mm



Otology

Micro ear forceps, straight

Material: Stainless steel

Other Sizes:

023-0001-26 : 4 x 0.6 mm



Otology

Micro ear forceps, curved upwards

Material: Stainless steel

Other Sizes:

023-0001-27 : 4 x 0.6 mm



Otology

Micro ear forceps, right

Material: Stainless steel

Other Sizes:

023-0001-28 : 4 x 0.6 mm



Otology

Micro ear forceps, left

Material: Stainless steel

Other Sizes:

023-0001-29 : 4 x 0.6 mm

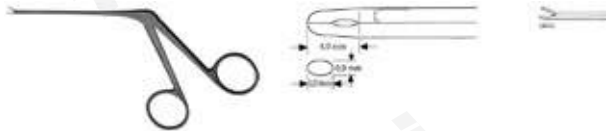

Otology

Micro cup shaped forceps, straight

Material: Stainless steel

Other Sizes:

023-0003-01 : 4 x 0.9 mm

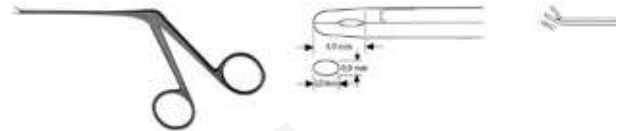

Otology

Micro cup shaped forceps, curved

Material: Stainless steel

Other Sizes:

023-0003-02 : 4 x 0.9 mm



Otology

Micro cup shaped forceps, right

Material: Stainless steel

Other Sizes:

023-0003-03 : 4 x 0.9 mm



Otology

Micro cup shaped forceps, left

Material: Stainless steel

Other Sizes:

023-0003-04 : 4 x 0.9 mm

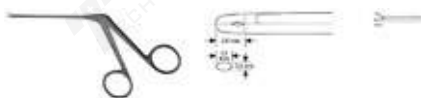

Otology

Micro cup shaped forceps, straight

Material: Stainless steel

Other Sizes:

023-0003-11 : 3.5 x 0.5 mm

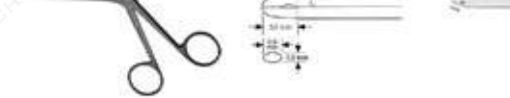

Otology

Micro cup shaped forceps, curved

Material: Stainless steel

Other Sizes:

023-0003-12 : 3.5 x 0.5 mm

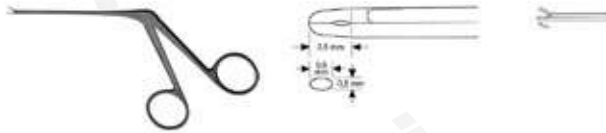

Otology

Micro cup shaped forceps, right

Material: Stainless steel

Other Sizes:

023-0003-13 : 3.5 x 0.5 mm

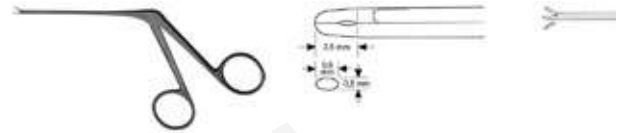

Otology

Micro cup shaped forceps, left

Material: Stainless steel

Other Sizes:

023-0003-14 : 3.5 x 0.5 mm



Otology

Micro ear scissors, acc. to Belluci, straight

Material: Stainless steel

Other Sizes:

023-0005-01 : 4 mm



Otology

Micro ear scissors, acc. to Belluci, curved

Material: Stainless steel

Other Sizes:

023-0005-02 : 4 mm



Otology

Micro ear scissors, acc. to Belluci, right curved

Material: Stainless steel

Other Sizes:

023-0005-03 : 4 mm

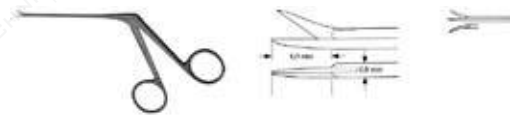

Otology

Micro ear scissors, acc. to Belluci, left curved

Material: Stainless steel

Other Sizes:

023-0005-04 : 4 mm



Otology

Approximator, acc. to Biemer-Mueller, straight

Material: Stainless steel

Other Sizes:

023-0005-51 : 4 mm



Otology

Micro ear scissors, acc. to Weitacc. to Laner-Wullstein, curved upwards

Material: Stainless steel

Other Sizes:

023-0005-52 : 4 mm



Otology

Micro ear scissors, acc. to Wullstein, right curved

Material: Stainless steel

Other Sizes:

023-0005-53 : 4 mm



Otology

Micro ear scissors, acc. to Wullstein, left curved

Material: Stainless steel

Other Sizes:

023-0005-54 : 4 mm



Otology

Wire closing forceps, acc. to McGee

Material: Stainless steel

Other Sizes:

023-0010-11 : 3.5 x 0.8 mm
023-0010-12 : 0.8 x 6.0 mm



Otology

Malleus nipper, curved upwards

Material: Stainless steel

Other Sizes:

023-0011-01 : 1.3 mm



Otology

Malleus nipper, curved downwards

Material: Stainless steel

Other Sizes:

023-0011-02 1.3 mm

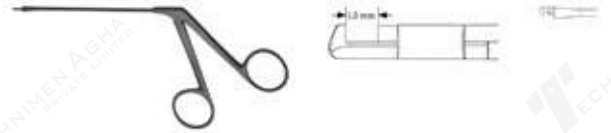

Otology

Malleus nipper, left

Material: Stainless steel

Other Sizes:

023-0011-07 1.3 mm



Otology

Malleus nipper, right

Material: Stainless steel

Other Sizes:

023-0011-06 1.3 mm



Otology

Introducing forceps, acc. to Fuller

Material: Stainless steel

Other Sizes:

023-0013-01 N/A



Otology

Sickle knife, acc. to Schuknecht, angled

Material: Stainless steel

Other Sizes:

023-0020-06 14.5 cm



Otology

Sickle knife, acc. to Wullstein, straight

Material: Stainless steel

Other Sizes:

023-0020-11 15.5 cm



Otology
Mucous knife, acc. to Tabb

Material: Stainless steel

Other Sizes:
023-0020-16 : 15.5 cm



Otology
Flap knife, acc. to Plester

Material: Stainless steel

Other Sizes:
023-0020-21 : 3.5 mm, 15 cm



Otology
Round cutting knife, acc. to Rosen

Material: Stainless steel

Other Sizes:
023-0022-01 : 3.0 mm, 15 cm
023-0022-02 : 2.8 mm, 15 cm
023-0022-03 : 2.6 mm, 15 cm
023-0022-04 : 2.0 mm, 15 cm
023-0022-05 : 1.6 mm, 15 cm
023-0022-06 : 1.4 mm, 15 cm
023-0022-07 : 1.0 mm, 15 cm



Otology
Needle, acc. to Barbara, straight

Material: Stainless steel

Other Sizes:
023-0024-01 : 16 cm



Otology
Needle, acc. to Barbara, curved, blunt

Material: Stainless steel

Other Sizes:
023-0024-02 : 16 cm



Otology
Needle, acc. to Barbara, slightly curved

Material: Stainless steel

Other Sizes:
023-0024-03 : 16 cm



Otology
Needle, acc. to Rosen, strongly curved

Material: Stainless steel

Other Sizes:
023-0024-04 16 cm



Otology
Hooklet, acc. to Barbara, 25°

Material: Stainless steel

Other Sizes:
023-0024-06 0.3 mm, 16 cm
023-0024-07 0.6 mm, 16 cm
023-0024-08 1.0 mm, 16 cm



Otology
Hooklet, acc. to Barbara, curved

Material: Stainless steel

Other Sizes:
023-0024-31 0.5 mm
023-0024-32 1.0 mm



Otology
Hooklet, acc. to Barbara, 90°

Material: Stainless steel

Other Sizes:
023-0024-21 0.3 mm, 16 cm
023-0024-22 0.6 mm, 16 cm
023-0024-23 1.0 mm, 16 cm
023-0024-24 1.2 mm, 16 cm
023-0024-25 1.5 mm, 16 cm
023-0024-26 2.0 mm, 16 cm
023-0024-27 2.5 mm, 16 cm



Otology
Hooklet, acc. to Barbara, 45°

Material: Stainless steel

Other Sizes:
023-0024-11 0.3 mm, 16 cm
023-0024-12 0.6 mm, 16 cm
023-0024-13 1.0 mm, 16 cm
023-0024-14 1.2 mm, 16 cm
023-0024-15 1.5 mm, 16 cm
023-0024-16 2.0 mm, 16 cm
023-0024-17 1.5 mm, 16 cm



Otology
Hooklet, 0.3 mm, 90° curved upwards

Material: Stainless steel

Other Sizes:
023-0025-01 0.3 mm, 15.5 cm
023-0025-02 0.6 mm, 15.5 cm
023-0025-03 1.0 mm, 15.5 cm



Otology
Hooklet, 0.3 mm, 90° curved downwards

Material: Stainless steel

Other Sizes:

023-0024-06	0.3 mm, 15.5 cm
023-0024-07	0.6 mm, 15.5 cm
023-0025-08	1.0 mm, 15.5 cm



Otology
Hooklet, 0.5 mm, curved upwards

Material: Stainless steel

Other Sizes:

023-0027-01	0.5 mm, 15.5 cm
023-0027-02	1.0 mm, 15.5 cm



Otology
Hooklet, 0.5 mm, curved downwards

Material: Stainless steel

Other Sizes:

023-0027-11	0.5 mm, 15.5 cm
023-0027-12	0.6 mm, 15.5 cm



Otology
Needle, acc. to Barbara, angled

Material: Stainless steel

Other Sizes:

023-0029-01	15.5 cm
-------------	---------



Otology
Needle, acc. to Barbara, angled, curved

Material: Stainless steel

Other Sizes:

023-0029-06	15.5 cm
-------------	---------



Otology
Micro ear hooklet, 25°

Material: Stainless steel

Other Sizes:

023-0030-06	0.3 mm, 15 cm
023-0030-07	0.6 mm, 15 cm



Otology
Micro ear hooklet, acc. to Shambaugh

Material: Stainless steel

Other Sizes:
023-0030-08 : 1.0 mm, 15 cm



Otology
Micro ear hooklet, 45°

Material: Stainless steel

Other Sizes:
023-0030-11 : 0.3 mm, 15 cm
023-0030-12 : 0.6 mm, 15 cm
023-0030-13 : 1.0 mm, 15 cm



Otology
Exploring hook, acc. to Shea, 45°, 2.0 mm

Material: Stainless steel

Other Sizes:
023-0030-20 : 15 cm



Otology
Atticus dissector, acc. to Austin, 3.0 mm

Material: Stainless steel

Other Sizes:
023-0030-30 : 15 cm



Otology
Dissector, acc. to FisCh, right, curved

Material: Stainless steel

Other Sizes:
023-0036-01 : 15.5 cm



Otology
Dissector, acc. to FisCh, left, curved

Material: Stainless steel

Other Sizes:
023-0036-02 : 15.5 cm



Otology
Dissector, acc. to FisCh, right, angled

Material: Stainless steel

Other Sizes:
023-0036-05 : 15.5 cm



Otology
Dissector, acc. to FisCh, left, angled

Material: Stainless steel

Other Sizes:
023-0036-06 : 15.5 cm



Otology
Micro raspatory, acc. to Rosen, curved

Material: Stainless steel

Other Sizes:
023-0036-23 : 15.5 cm



Otology
Measuring probe

Material: Stainless steel

Other Sizes:
023-0038-01 : 3.5 mm, 15.5 cm
023-0038-02 : 4.0 mm, 15.5 cm
023-0038-03 : 4.5 mm, 15.5 cm
023-0038-04 : 5.0 mm, 15.5 cm



Otology
Ear curette, acc. to House, double-ended, 1.0/1.2 mm

Material: Stainless steel

Other Sizes:
023-0044-01 : 14.5 cm



Otology
Ear curette, acc. to House, double-ended, 1.5/1.8 mm

Material: Stainless steel

Other Sizes:
023-044-02 : 14.5 cm



Otology

Ear specula set, acc. to Hartmann, fig. 0 - 2

Material: Material: steel 18/8 martinit, antimagnetic, stainless, acid-resistant

Other Sizes:
023-0112-03 : N/A



Otology

Ear speculum, acc. to Hartmann, fig. 0, Ø 3.0 mm

Material: Material: steel 18/8 martinit, antimagnetic, stainless, acid-resistant

Other Sizes:
023-0112-10 : 3.6 cm



Otology

Ear speculum, acc. to Hartmann, fig. 1, Ø 4.0 mm

Material: Material: steel 18/8 martinit, antimagnetic, stainless, acid-resistant

Other Sizes:
023-0112-11 : 3.6 cm



Otology

Ear speculum, acc. to Hartmann, fig. 2, Ø 5.0 mm

Material: Material: steel 18/8 martinit, antimagnetic, stainless, acid-resistant

Other Sizes:
023-0112-12 : 3.6 cm



Otology

Ear speculum, acc. to Hartmann, fig. 3, Ø 6.0 mm

Material: Material: steel 18/8 martinit, antimagnetic, stainless, acid-resistant

Other Sizes:
023-0112-13 : 3.6 cm



Otology

Ear speculum, acc. to Hartmann, fig. 4, Ø 7.5 mm

Material: Material: steel 18/8 martinit, antimagnetic, stainless, acid-resistant

Other Sizes:
023-0112-14 : 3.6 cm



Otology

Ear specula set, acc. to Hartmann, fig. 2 - 4

Material: Material: steel 18/8 martinit, antimagnetic, stainless, acid-resistant

Other Sizes:
023-0114-03 : N/A



Otology

Ear specula set, acc. to Hartmann, fig. 1 - 4

Material: Material: steel 18/8 martinit, antimagnetic, stainless, acid-resistant

Other Sizes:
023-0115-04 : N/A



Otology

Ear specula set, acc. to Toynbee, fig. 2 - 4

Material: Material: steel 18/8 martinit, antimagnetic, stainless, acid-resistant

Other Sizes:
023-0118-03 : N/A



Otology

Ear speculum, acc. to Toynbee, fig. 1, Ø 4.0 mm

Material: Material: steel 18/8 martinit, antimagnetic, stainless, acid-resistant

Other Sizes:
023-0118-11 : 3.6 cm



Otology

Ear speculum, acc. to Toynbee, fig. 2, Ø 5.0 mm

Material: Material: steel 18/8 martinit, antimagnetic, stainless, acid-resistant

Other Sizes:
023-0118-12 : 3.6 cm



Otology

Ear speculum, acc. to Toynbee, fig. 3, Ø 6.0 mm

Material: Material: steel 18/8 martinit, antimagnetic, stainless, acid-resistant

Other Sizes:
023-0118-13 : 3.6 cm



Otology

Ear speculum, acc. to Toynebee, fig. 4, Ø 7.5 mm

Material: Material: steel 18/8 martinit, antimagnetic, stainless, acid-resistant

Other Sizes:
023-0118-14 : 3.6 cm

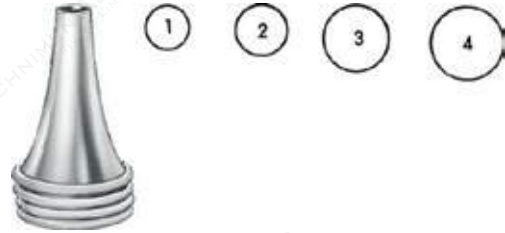

Otology

Ear specula set, acc. to Toynebee, fig. 1-4

Material: Material: steel 18/8 martinit, antimagnetic, stainless, acid-resistant

Other Sizes:
023-0112-03 : N/A

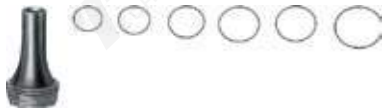

Otology

Ear specula set, acc. to Zoellner, fig. 1-6

Material: stainless steel

Other Sizes:
023-0132-00 : N/A
023-0132-01 : 5.5 x 6.5 mm. 3.8 cm
023-0132-02 : 6.5 x 7.5 mm. 3.8 cm
023-0132-03 : 7.5 x 8.5 mm. 3.8 cm
023-0132-04 : 8.5 x 9.5 mm. 3.8 cm
023-0132-05 : 9.5 x 10.5 mm. 3.8 cm
023-0132-06 : 10.5 x 11.5 mm. 3.8 cm



Otology

Ear speculum, acc. to Farrior, fig. 1, Ø 5.5 mm

Material: stainless steel

Other Sizes:
023-0134-01 : 3.6 cm



Otology

Ear speculum, acc. to Farrior, fig. 2, Ø 6.5 mm

Material: stainless steel

Other Sizes:
023-0134-02 : 3.6 cm



Otology

Ear speculum, acc. to Farrior, fig. 3, Ø 7.5 mm

Material: stainless steel

Other Sizes:
023-0134-03 : 3.6 cm



Otology
Ear speculum, acc. to Farris, fig. 4, Ø 8.5 mm

Material: Stainless steel

Other Sizes:
023-0134-04 : 3.6 cm



Otology
Ear speculum, acc. to Farris, fig. 5, Ø 9.5 mm

Material: Stainless steel

Other Sizes:
023-0134-05 : 3.6 cm



Otology
Ear speculum, acc. to Farris, fig. 6, Ø 10.5 mm

Material: Stainless steel

Other Sizes:
003-0134-20 : 20 cm



Otology
Ear speculum, acc. to Farris, fig. 6, Ø 10.5 mm

Material: Stainless steel

Other Sizes:
023-0134-06 : 3.6 cm



Otology
Metal rack, for 12 ear specula

Material: steel 18/8 martinit, antimagnetic, stainless, acid-resistant

Other Sizes:
023-0148-12 : N/A



Otology
Tuning fork, acc. to FrenCh, C2 16

Material: all other, not specially marked material types

Other Sizes:
023-0170-07 : N/A



Otology

Tuning fork, acc. to FrenCh, C1 32

Material: all other, not specially marked material types

Other Sizes:
023-0172-08 : N/A



Otology

Tuning fork, acc. to Hartmann, C 64

Material: all other, not specially marked material types

Other Sizes:
023-0174-09 : N/A



Otology

Tuning fork, acc. to Hartmann, C 128

Material: all other, not specially marked material types

Other Sizes:
023-0175-10 : N/A



Otology

Tuning fork, acc. to Hartmann, C1 256

Material: all other, not specially marked material types

Other Sizes:
023-0177-11 : N/A



Otology

Tuning fork, acc. to Martin, Aluminium, C 128

Material: all other, not specially marked material types

Other Sizes:
023-0180-10 : N/A



Otology

Tuning fork, acc. to Martin, Aluminium, C1 256

Material: all other, not specially marked material types

Other Sizes:
023-0182-11 : N/A



Otology

Tuning fork, acc. to Martin, Aluminium, C2 512

Material: all other, not specially marked material types

Other Sizes:
023-0184-12 : N/A



Otology

Tuning fork, acc. to Martin, Aluminium, C3 1024

Material: all other, not specially marked material types

Other Sizes:
023-0186-13 : N/A



Otology

Tuning fork, acc. to Martin, Aluminium, C4 2048

Material: all other, not specially marked material types

Other Sizes:
023-0188-14 : N/A



Otology

Tuning fork, acc. to Hartmann, C 128

Material: all other, not specially marked material types

Other Sizes:
023-0189-10 : N/A



Otology

Tuning fork, acc. to Hartmann, C1 256

Material: all other, not specially marked material types

Other Sizes:
023-0192-11 : N/A



Otology

Tuning fork, acc. to Hartmann, C2 512

Material: all other, not specially marked material types

Other Sizes:
023-0194-12 : N/A



Otology

Tuning fork, acc. to Hartmann, C3 1024

Material: all other, not specially marked material types

Other Sizes:

023-0196-13 : N/A



Otology

Tuning fork, acc. to Hartmann, C4 2048

Material: all other, not specially marked material types

Other Sizes:

023-0198-14 : N/A



Otology

uning fork, acc. to Hartmann, C5 4096

Material: all other, not specially marked material types

Other Sizes:

023-0200-15 : N/A



Otology

Tuning fork, acc. to Lucae, with socket, C 128

Material: all other, not specially marked material types

Other Sizes:

023-0210-10 : N/A



Otology

Tuning fork, acc. to Lucae, with socket, C1 256

Material: all other, not specially marked material types

Other Sizes:

023-0212-11 : N/A



Otology

Tuning fork, acc. to Lucae, with socket, C2 512

Material: all other, not specially marked material types

Other Sizes:

023-0214-12 : N/A



Otology

Tuning fork, acc. to Lucae, with socket, C3 1024

Material: all other, not specially marked material types

Other Sizes:
023-0172-08 : N/A



Otology

Tuning fork, acc. to Lucae, with socket, C4 2048

Material: all other, not specially marked material types

Other Sizes:
023-0218-14 : N/A



Otology

Tuning fork, acc. to Lucae, with socket, C5 4096

Material: all other, not specially marked material types

Other Sizes:
023-0220-15 : N/A



Otology

Pare socket for tuning fork

Material: Replacement part

Other Sizes:
023-0221-91 : N/A



Otology

Tuning fork, acc. to Hartmann, moveable up to "h", C 128

Material: all other, not specially marked material types

Other Sizes:
023-0222-10 : N/A



Otology

Tuning fork, acc. to Hartmann, C1 256

Material: all other, not specially marked material types

Other Sizes:
023-0223-11 : N/A



Otology
Socket only

Material: Replacement part

Other Sizes:
023-0223-90 : N/A



Otology
Tuning fork, acc. to Rydel-Seiffer,
C 64/C 128

Material: all other, not specially marked
material types

Other Sizes:
023-0224-10 : N/A



Otology
Damper, right, white scale

Material: Replacement part

Other Sizes:
023-0224-90 : N/A



Otology
Damper, left, black scale

Material: Replacement part

Other Sizes:
023-0224-91 : N/A



Otology
Knurled screw, only, for 023-0224-10

Material: Replacement part

Other Sizes:
023-0224-92 : N/A



Otology
Weights C 64, adjustable, for 023-0224-10

Material: Replacement part

Other Sizes:
023-0224-93 : N/A



Otology

Socket for tuning forks

Material: Replacement part

Other Sizes:
023-0226-00 : N/A



Otology

Tuning fork, acc. to , KOENIG,
W. SOCKET, A 109

Material: all other, not specially
marked material types

Other Sizes:
023-0230-59 : N/A



Otology

Tuning fork, with socket, a1 440

Material: all other, not specially
marked material types

Other Sizes:
023-0234-61 : N/A



Otology

Socket for tuning forks

Material: Stainless steel

Other Sizes:
023-0234-90 : N/A



Otology

Nasal cutting forceps, acc. to Henckel-Tilley

Material: Stainless steel

Other Sizes:
023-0316-11 : 6.5 mm



Otology

EustaChian catheter, acc. to Hartmann

Material: steel 18/8 martinit,
antimagnetic, stainless, acid-resistant

Other Sizes:
023-0321-01 : 3.0 mm, 15 cm
023-0321-02 : 3.5 mm, 15 cm
023-0321-03 : 4.0 mm, 15 cm



Otology
Ear polypus snare, acc. to Krause

Material: Stainless steel

Other Sizes:
023-0351-16 : 18.5 cm



Otology
Ear polypus snare, acc. to Krause-Voss

Material: Stainless steel

Other Sizes:
023-0353-16 : 18.5 cm



Otology
Loop holder, for 023-0353-16

Material: Replacement part

Other Sizes:
023-0353-90 : N/A



Otology
Snare wire, Ø 0.3 mm, ring of 10 m

Material: steel 18/8 martinit,
antimagnetic, stainless, acid-resistant

Other Sizes:
023-0358-30 : Ø 0,3 mm
023-0358-40 : Ø 0,4 mm



Otology
Ear dressing forceps, acc.
to TroeltsCh, 10.5 cm

Material: Stainless steel

Other Sizes:
023-0371-11 : 10.5 cm



Otology
Ear dressing forceps, acc.
to TroeltsCh, 11 cm

Material: Stainless steel

Other Sizes:
023-0375-12 : 11 cm



Otology
Ear dressing forceps, acc. to Troeltsch, Bulldog 12.5 cm

Material: Stainless steel

Other Sizes:
023-0381-13 12.5 cm



Otology
Ear forceps, acc. to Gruenewald, bayonet-shape, 14.5 cm

Material: Stainless steel

Other Sizes:
023-0391-14 14.5 cm



Otology
Ear dressing forceps, acc. to Jansen, bayonet-shape

Material: Stainless steel

Other Sizes:
023-0395-16 16 cm
023-0395-20 21.5 cm



Otology
Ear polypus forceps, acc. to Littauer

Material: Stainless steel

Other Sizes:
023-0401-12 10 cm



Otology
Ear polypus forceps, acc. to Hartmann, fine

Material: Stainless steel

Other Sizes:
023-0405-12 12 cm



Otology
Ear polypus forceps, acc. to Hartmann

Material: Stainless steel

Other Sizes:
023-0407-14 14 cm



Otology
Foreign body forceps, acc. to Buck

Material: Stainless steel

Other Sizes:
023-0416-11 : 11.5 cm



Otology
Ear foreign body lever, acc. to Quire

Material: Stainless steel

Other Sizes:
023-0418-10 : 10.5 cm



Otology
Ear polypus forceps, acc. to Hartmann-Wullstein

Material: Stainless steel

Other Sizes:
023-0425-08 : 8 cm



Otology
Ear polypus forceps, acc. to Hartmann-Wullstein

Material: Stainless steel

Other Sizes:
023-0427-08 : 1 mm



Otology
Ear polypus forceps, acc. to Hartmann

Material: Stainless steel

Other Sizes:
023-0430-08 : 8 cm
023-0430-14 : 14 cm



Otology
Ear forceps, acc. to Hartmann, spoon-shape

Material: Stainless steel

Other Sizes:
023-0442-81 : 2.0 mm
023-0442-82 : 2.5 mm
023-0442-83 : 3.0 mm



Otology

Ear polypus forceps, acc. to Struempel

Material: Stainless steel

Other Sizes:

023-0448-08 8 cm



Otology

Ear polypus forceps, acc. to Hartmann-Hoffmann

Material: Stainless steel

Other Sizes:

023-0456-08 2.0 mm



Otology

Bone punCh, acc. to Citelli

Material: Stainless steel

Other Sizes:

023-0461-17 3 mm

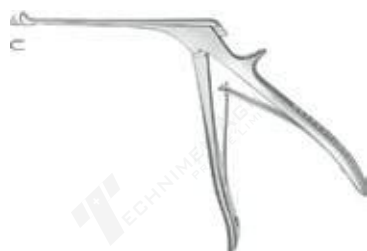

Otology

Bone punCh, acc. to Beyer

Material: Stainless steel

Other Sizes:

023-0463-19 2 mm



Otology

Bone punCh, acc. to Beyer

Material: Stainless steel

Other Sizes:

023-0466-14 1 mm



Otology

Ear curette, acc. to Langenbeck, blunt

Material: Stainless steel

Other Sizes:

023-0491-13 13 cm



Otology

Ear curette, acc. to Buck, curved, sharp

Material: Stainless steel

Other Sizes:

023-0498-01	17 cm
023-0498-02	17 cm
023-0498-10	17 cm
023-0498-11	17 cm
023-0498-12	17 cm
023-0498-13	17 cm
023-0498-14	17 cm



Otology

Ear curette, acc. to Buck, straight, blunt

Material: Stainless steel

Other Sizes:

023-0495-02	17 cm
023-0495-10	17 cm
023-0495-11	17 cm
023-0495-12	17 cm



Otology

Ear curette, acc. to Buck, curved, blunt

Material: Stainless steel

Other Sizes:

023-0497-01	17 cm
023-0497-02	17 cm
023-0497-10	17 cm
023-0497-11	17 cm
023-0497-12	17 cm
023-0497-13	17 cm
023-0497-14	17 cm



Otology

Ear curette, acc. to Shapleigh

Material: Stainless steel

Other Sizes:

023-0493-01	15 cm
023-0493-02	15 cm



Otology

Ear curette, acc. to Jansen, double-ended, sharp

Material: Stainless steel

Other Sizes:

023-0532-15	16 cm
-------------	-------



Otology

Curette/hooklet, acc. to Gross, blunt

Material: Stainless steel

Other Sizes:

023-0543-12	13 cm
-------------	-------



Otology
Foreign body loop, acc. to Weber

Material: Stainless steel

Other Sizes:
023-0551-01 : 17 cm



Otology
Foreign body lever, acc. to Moldenhauer

Material: Stainless steel

Other Sizes:
023-0561-16 : 15 cm



Otology
Foreign body lever, acc. to Zaufal

Material: Stainless steel

Other Sizes:
023-0563-16 : 15 cm



Otology
Ear hooklet, acc. to Hartmann, sharp

Material: Stainless steel

Other Sizes:
023-0570-16 : 16 cm



Otology
Hooklet, probe-end, acc. to Lucae

Material: Stainless steel

Other Sizes:
023-0577-01 : small, 14 cm
023-0577-02 : medium, 14 cm
023-0577-03 : large, 14 cm



Otology
Hooklet, probe-end, acc. to Wagener

Material: Stainless steel

Other Sizes:
023-0585-01 : 14 cm
023-0585-02 : 14 cm
023-0585-03 : 14 cm
023-0585-04 : 14 cm
023-0585-05 : 14 cm



Otology
Hooklet, probe-end, acc. to Wagener, curved, sharp

Material: Stainless steel

Other Sizes:
023-0585-06 : 14 cm
023-0585-07 : 14 cm



Otology
Ear hooklet, acc. to Day, hook

Material: Stainless steel

Other Sizes:
023-0589-01 : long, 17 cm
023-0589-02 : short, 17 cm



Otology
N/A

Material: Stainless steel

Other Sizes:
023-0613-16 : 14.5 cm



Otology
Tympanium perforator, straight

Material: Stainless steel

Other Sizes:
023-0630-16 : 14.5 cm



Otology
Tympanium perforator, vertical

Material: Stainless steel

Other Sizes:
023-0655-16 : 15.5 cm



Otology
Tympanium perforator, horizontal

Material: Stainless steel

Other Sizes:
023-0657-16 : 16 cm



Otology
Tympanium perforator, acc. to Lucae, vertical

Material: Stainless steel

Other Sizes:
023-0661-18 : 17.5 cm



Otology
Tympanium perforator, acc. to Lucae, horizontal

Material: Stainless steel

Other Sizes:
023-0663-18 : 17.5 cm



Otology
Raspatory, acc. to Lempert, curved

Material: Stainless steel

Other Sizes:
023-0737-20 : 20.5 cm



Otology
Raspatory, acc. to Lempert, straight curved

Material: Stainless steel

Other Sizes:
023-0739-17 : 18 cm



Otology
Curette, acc. to Lempert, sharp

Material: Stainless steel

Other Sizes:
023-0743-10 : 21.5 cm
023-0743-20 : 21.5 cm
023-0743-30 : 21.5 cm
023-0743-40 : 21.5 cm
023-0743-50 : 21.5 cm



Otology
Atomizer, acc. to Kabierske, complete

Material: steel 18/8 martinit, antimagnetic, stainless, acid-resistant

Other Sizes:
023-0780-00 : N/A



Otology

Boottle only, for 023-0780-00

Material: all other, not specially marked material types

Other Sizes:
023-0780-01 : 30 cm



Otology

Ear cannula, acc. to Kabierske, straight

Material: steel 18/8 martinit, antimagnetic, stainless, acid-resistant

Other Sizes:
023-0780-08 : 8 cm



Otology

Ear cannula, acc. to Kabierske, straight

Material: steel 18/8 martinit, antimagnetic, stainless, acid-resistant

Other Sizes:
023-0780-11 : 11 cm



Otology

Ear cannula, acc. to Kabierske, curved

Material: steel 18/8 martinit, antimagnetic, stainless, acid-resistant

Other Sizes:
023-0780-13 : 13 cm



Otology

Rubber ball, for 023-0780-00

Material: all other, not specially marked material types

Other Sizes:
023-0780-50 : N/A



Otology

Ring Gasket, for 023-0780-00

Material: Replacement part

Other Sizes:
023-0780-90 : N/A



Otology
Midsection for atomizer, with ball

Material: Replacement part

Other Sizes:
023-0780-91 : N/A



Otology
Atomizer, without cannulas

Material: Replacement part

Other Sizes:
023-0780-92 : N/A



Otology
Atomizer, "Universal", complete

Material: chrome-plated

Other Sizes:
023-0786-00 : N/A



Otology
Atomizer, "Universal", without blower

Material: chrome-plated

Other Sizes:
023-0786-01 : N/A



Otology
Air douChe, acc. to Politzer, for nose

Material: chrome-plated

Other Sizes:
023-0792-00 : N/A



Otology
Air douChe, acc. to Politzer, for nose and ear

Material: chrome-plated

Other Sizes:
023-0792-01 : N/A



Otology

Air douChe, acc. to Politzer, complete in box

Material: chrome-plated

Other Sizes:
023-0792-02 : N/A



Otology

Connecting nozzle, for 023-0792-00

Material: chrome-plated

Other Sizes:
023-0792-03 : N/A



Otology

Ear tip, acc. to Politzer, olive-shaped

Material: chrome-plated

Other Sizes:
023-0792-04 : Ø 4 mm



Otology

Nose tip, acc. to Politzer, olive-shaped

Material: chrome-plated

Other Sizes:
023-0792-15 : Ø 15 mm
023-0792-17 : Ø 17 mm
023-0792-22 : Ø 22 mm



Otology

Rubber bulb, acc. to Politzer, for 023-0792-00

Material: all other, not specially marked material types

Other Sizes:
023-0792-50 : N/A



Otology

Ear syringe, 10 ml, self-filling, complete

Material: chrome-plated

Other Sizes:
023-0794-00 : N/A



Otology
Valve insert, for 023-0794-00

Material: chrome-plated

Other Sizes:
023-0794-02 : N/A

Otology
Plastic tube, without socket

Material: all other, not specially marked material types

Other Sizes:
023-0794-03 : N/A

Otology
Suction socket, for 023-0794-00

Material: chrome-plated

Other Sizes:
023-0794-04 : N/A



Otology
Protection shield, for 023-0794-00

Material: chrome-plated

Other Sizes:
023-0794-05 : N/A



Otology
Ear tip, olive-shaped, for 023-0794-00

Material: chrome-plated

Other Sizes:
023-0794-06 : N/A



Otology
Ear tip, cone-shaped, for 023-0794-00

Material: chrome-plated

Other Sizes:
023-0794-07 : N/A



Otology
Fistula tip, button-ended, for 023-0794-00

Material: chrome-plated

Other Sizes:
023-0794-08 N/A



Otology
Threaded tip for catheter, for 023-0794-00

Material: chrome-plated

Other Sizes:
023-0794-09 N/A



Otology
Ear syringe, three rings, complete

Material: chrome-plated

Other Sizes:
023-0795-00 50 ml
023-0795-04 100 ml



Otology
Ear syringe, for 023-0795-04

Material: Replacement part

Other Sizes:
023-0795-90 N/A



Otology
Irrigating tip, olive-shaped

Material: Replacement part

Other Sizes:
023-0795-91 N/A



Otology
Irrigating tip, cone-shaped

Material: Replacement part

Other Sizes:
023-0795-92 N/A



Otology
Rubber bulb, for 023-0786-01

Material: all other, not specially marked material types

Other Sizes:
023-0851-05 N/A

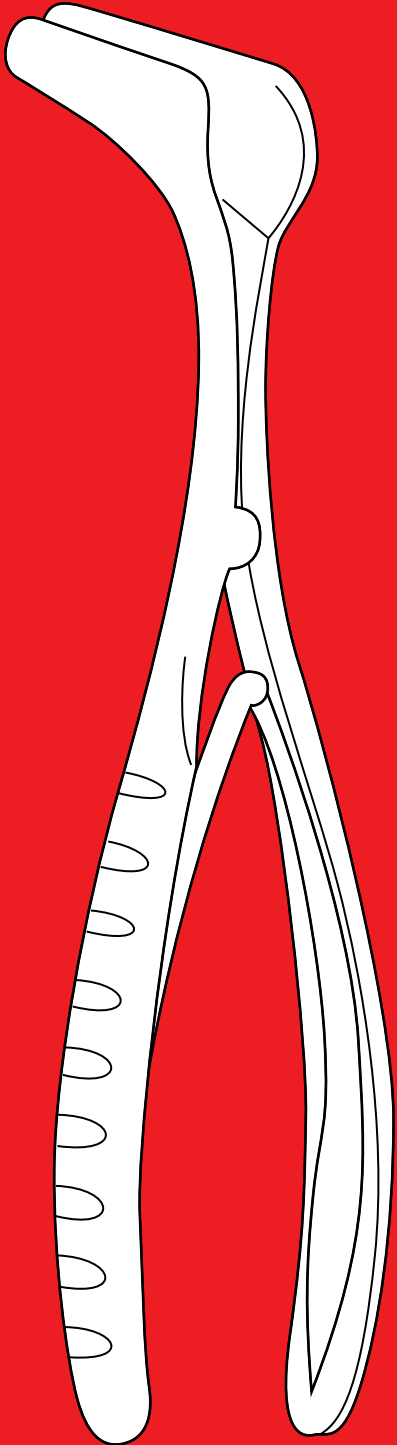

RHINOLOGY

— RANGE



DISCOVER NOW

“Instruments for
surgical procedures”
Since 1970



Rhinology
Nasal tampon forceps, acc. to TroeltsCh

Material: Stainless steel

Other Sizes:
024-0101-15 : 14.5 cm



Rhinology
Nasal tampon forceps, acc. to TroeltsCh

Material: Stainless steel

Other Sizes:
024-0105-18 : 15.5 cm



Rhinology
Nasal tampon forceps, acc. to Gruenwald

Material: Stainless steel

Other Sizes:
024-01115-20 : 21.5 cm



Rhinology
Nasal tampon forceps, acc. to Westmacott

Material: Stainless steel

Other Sizes:
024-0121-20 : 20 cm

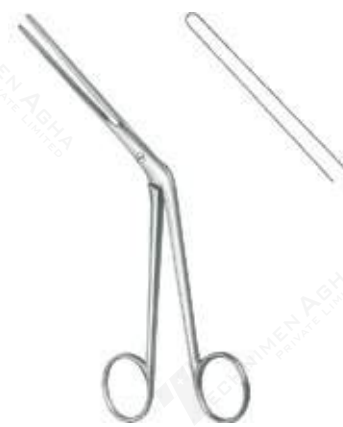

Rhinology
Nasal tampon forceps, acc. to Lubet-Barbon

Material: Stainless steel

Other Sizes:
024-0129-20 : 18.5 cm



Rhinology
N/A

Material: Stainless steel

Other Sizes:
024-0141-16 : 15 cm



Rhinology
Nasal tampon forceps, acc. to Hartmann

Material: Stainless steel

Other Sizes:
024-0145-20 : 18.5 cm



Rhinology
N/A

Material: Stainless steel

Other Sizes:
024-0161-17 : 16 cm



Rhinology
Nasal tampon forceps, acc. to Knight

Material: Stainless steel

Other Sizes:
024-0207-18 : 17 cm



Rhinology
Septum and vomer forceps, acc. to Craig

Material: Stainless steel

Other Sizes:
024-0213-18 : 16 cm



Rhinology
Septum forceps, curved left

Material: Stainless steel

Other Sizes:
024-0215-01 : 15.5 cm



Rhinology
Septum forceps, curved right

Material: Stainless steel

Other Sizes:
024-0215-02 : 15.5 cm



Rhinology

Septum forceps, acc. to Bruenings

Material: Stainless steel

Other Sizes:

024-0227-01	6.6 mm, 16.5 cm
024-0227-02	7.6 mm, 16.5 cm
024-0227-03	8.7 mm, 16.5 cm
024-0227-04	9.6 mm, 16.5 cm



Rhinology

Ethmoidal forceps, acc. to Takahashi, straight

Material: Stainless steel

Other Sizes:

024-0235-12	19 cm
-------------	-------



Rhinology

Ethmoidal forceps, acc. to Takahashi, curved

Material: Stainless steel

Other Sizes:

024-0237-12	19 cm
-------------	-------



Rhinology

Ethmoidal forceps, acc. to Watson-William, serrated

Material: Stainless steel

Other Sizes:

024-0241-10	19 cm
-------------	-------



Rhinology

Ethmoidal forceps, acc. to Watson-William

Material: Stainless steel

Other Sizes:

024-0241-12	19 cm
-------------	-------



Rhinology

Nasal cutting forceps, acc. to Weil

Material: Stainless steel

Other Sizes:

024-0249-12	19 cm
-------------	-------



Rhinology

Nasal cutting forceps, acc. to Weil-acc. to Blakesley

Material: Stainless steel

Other Sizes:

024-0255-01	3.0 mm, 12 cm
024-0255-02	3.5 mm, 12 cm
024-0255-03	4.5 mm, 12 cm
024-0255-04	5.0 mm, 12 cm
024-0255-05	5.5 mm, 12 cm



Rhinology

Ethmoidal forceps, angled upward, 45°

Material: Stainless steel

Other Sizes:

024-0256-01	3.0 mm, 12 cm
024-0256-02	3.5 mm, 12 cm
024-0256-03	4.5 mm, 12 cm
024-0256-04	5.0 mm, 12 cm



Rhinology

Ethmoidal forceps, angled upward, 90°

Material: Stainless steel

Other Sizes:

024-0258-01	3.0 mm, 12 cm
024-0258-02	3.5 mm, 12 cm
024-0258-03	4.5 mm, 12 cm
024-0258-04	5.0 mm, 12 cm



Rhinology

Ethmoidal forceps, acc. to St. Barts, straight

Material: Stainless steel

Other Sizes:

024-0259-12	12 cm
-------------	-------



Rhinology

Ethmoidal forceps, acc. to St. Barts, angled upward, 30°

Material: Stainless steel

Other Sizes:

024-0260-12	12 cm
-------------	-------



Rhinology

Ethmoidal forceps, acc. to St. Barts, angled downward, 30°

Material: Stainless steel

Other Sizes:

024-0261-12	12 cm
-------------	-------



Rhinology

Nasal cutting forceps, acc. to Struycken

Material: Stainless steel

Other Sizes:

024-0285-01	0.9 mm, 19 cm
024-0285-02	1.2 mm, 19 cm



Rhinology

Antrium punCh, 2.5 mm,
retrograde cutting upward

Material: Stainless steel

Other Sizes:

024-0308-01	10 cm
-------------	-------



Rhinology

Antrium punCh, 2.5 mm,
retrograde cutting right

Material: Stainless steel

Other Sizes:

024-0308-02	10 cm
-------------	-------



Rhinology

Antrium punCh, 2.5 mm, retrograde
cutting left

Material: Stainless steel

Other Sizes:

024-0308-03	10 cm
-------------	-------



Rhinology

Nasal cutting forceps, acc. to Hartmann

Material: Stainless steel

Other Sizes:

024-0309-01	Ø 5 mm, 19 cm
024-0309-02	Ø 7 mm, 19 cm
024-0309-03	Ø 9 mm, 19 cm
024-0309-04	Ø 11 mm, 19 cm



Rhinology

Septum forceps, acc. to Middleton, open

Material: Stainless steel

Other Sizes:

024-0323-19	19 cm
-------------	-------



Rhinology
Septum forceps, acc. to Middleton, closed

Material: Stainless steel

Other Sizes:
024-0327-19 : 19 cm



Rhinology
Septum forceps, acc. to Caplan, serrated

Material: Stainless steel

Other Sizes:
024-0331-20 : 20 cm



Rhinology
Septum morselizer, acc. to Garney, angled

Material: Stainless steel

Other Sizes:
024-0334-21 : 20 cm



Rhinology
Protection cap, for 024-0335-21

Material: Stainless steel

Other Sizes:
024-0335-01 : N/A



Rhinology
Septum morselizer, acc. to Rubin

Material: Stainless steel

Other Sizes:
024-0335-20 : 20 cm



Rhinology
Septum morselizer, acc. to Rubin

Material: octagonal handle

Other Sizes:
024-0335-21 : 21 cm



Rhinology

TC septum morselizer, acc. to Rubin

Material: Stainless steel

Other Sizes:

024-0337-21 : 18.5 cm



Rhinology

Sphenoidal punch, acc. to Hajek,
cutting upward

Material: Stainless steel

Other Sizes:

024-0340-13 : 14 cm



Rhinology

Sphenoidal punch, acc. to Hajek,
cutting downward

Material: Stainless steel

Other Sizes:

024-0341-13 : 14 cm



Rhinology

Sphenoidal punch, cutting
upward, 3.5 x 3.5 mm

Material: Stainless steel

Other Sizes:

024-0342-12 : 14 cm



Rhinology

Sphenoidal punch, cutting
downward, 3.5 x 3.5 mm

Material: Stainless steel

Other Sizes:

024-0343-12 : 14 cm



Rhinology

Sphenoidal punch, cutting upward,
3 x 3 mm

Material: Stainless steel

Other Sizes:

024-0356-17 : 18 cm



Rhinology
Sphenoidal punCh, cutting downward,
3 x 3 mm

Material: Stainless steel

Other Sizes:
024-0357-17 : 18 cm



Rhinology
Sphenoidal punCh, cutting upward,

Material: Stainless steel

Other Sizes:
024-0362-03 : 3 mm, 18 cm
024-0362-05 : 5 mm, 18 cm



Rhinology
Antrum punCh, acc. to Kerrison,
cutting upward

Material: Stainless steel

Other Sizes:
024-0389-00 : 3 x 3 mm, 9 cm
024-0389-01 : 4 x 4 mm, 9 cm
024-0389-02 : 5 x 5 mm, 9 cm
024-0389-03 : 6 x 6 mm, 9 cm



Rhinology
Rhinoplastic knife, acc. to Joseph

Material: Stainless steel

Other Sizes:
024-0440-01 : 15 cm
024-0441-01 : 15 cm



Rhinology
Rhinoplastic knife, acc. to Fomon, curved

Material: Stainless steel

Other Sizes:
024-0444-16 : 16.5 cm



Rhinology
Rhinoplastic knife, acc. to Converse, curved

Material: Stainless steel

Other Sizes:
024-0459-16 : 16 cm



Rhinology
Rhinoplastic knife, acc. to Joseph, straight

Material: Stainless steel

Other Sizes:
024-0466-15 : 15.5 cm



Rhinology
Rhinoplastic knife, acc. to Cottle, straight

Material: Stainless steel

Other Sizes:
024-0468-15 : 14 cm



Rhinology
Mucous knife, acc. to Freer

Material: Stainless steel

Other Sizes:
024-0484-15 : 16.5 cm



Rhinology
Septum knife, acc. to Freer, curved

Material: Stainless steel

Other Sizes:
024-0497-19 : 19 cm



Rhinology
Septum knife, acc. to Freer, angled

Material: Stainless steel

Other Sizes:
024-0499-19 : 18.5 cm



Rhinology
Swivel knife, acc. to Ballenger, straight

Material: Stainless steel

Other Sizes:
024-0504-03 : 3 mm, 21 cm
024-0504-04 : 4 mm, 21 cm
024-0504-05 : 5 mm, 21 cm



Rhinology

Swivel knife, acc. to Ballenger, bayonet-shape

Material: Stainless steel

Other Sizes:

024-0505-03	3 mm, 20.5 cm
024-0505-04	4 mm, 20.5 cm
024-0505-05	5 mm, 20.5 cm



Rhinology

Septum elevator, acc. to McKenty

Material: Stainless steel

Other Sizes:

024-0521-04	4 mm, 15 cm
-------------	-------------



Rhinology

Septum elevator, acc. to Halle

Material: Stainless steel

Other Sizes:

024-0525-16	3.5 mm, 16 cm
-------------	---------------



Rhinology

Septum elevator, acc. to Joseph

Material: Stainless steel

Other Sizes:

024-0531-16	4 mm, 16 cm
-------------	-------------



Rhinology

Septum elevator, acc. to Freer, sharp

Material: Stainless steel

Other Sizes:

024-0541-19	5 mm, 19 cm
-------------	-------------



Rhinology

Septum elevator, acc. to Freer, blunt

Material: Stainless steel

Other Sizes:

024-0543-19	6 mm, 19 cm
-------------	-------------



Rhinology
Palatal raspatory, slightly curved

Material: Stainless steel

Other Sizes:
024-0544-01 : 24.5 cm



Rhinology
Palatal raspatory, strongly curved

Material: Stainless steel

Other Sizes:
024-0544-02 : 24 cm



Rhinology
Elevator, acc. to Freer, pointed/blunt, without pin

Material: Stainless steel

Other Sizes:
024-0545-18 : 18 cm



Rhinology
Septum elevator, acc. to Freer, pointed/blunt

Material: Stainless steel

Other Sizes:
024-0546-18 : 18.5 cm



Rhinology
Septum elevator, acc. to Freer, double-ended

Material: Stainless steel

Other Sizes:
024-0547-20 : 20.5 cm



Rhinology
Elevator, acc. to McKenty

Material: Stainless steel

Other Sizes:
024-0549-22 : 4 mm, 20.5 cm



Rhinology
Elevator, acc. to Ballenger-Hajek

Material: Stainless steel

Other Sizes:
024-0550-19 6 mm, 19 cm



Rhinology
Elevator, acc. to Howarth

Material: Stainless steel

Other Sizes:
024-0557-22 21.5 cm



Rhinology
Elevator, acc. to Cottle

Material: Stainless steel

Other Sizes:
024-0559-23 23.5 cm



Rhinology
Septum elevator, acc. to Killian

Material: Stainless steel

Other Sizes:
024-0560-18 4 mm, 18 cm



Rhinology
Septum elevator, acc. to Killian

Material: Stainless steel

Other Sizes:
024-0562-22 4.5 mm, 23 cm



Rhinology
Septum elevator, acc. to Pennington

Material: Stainless steel

Other Sizes:
024-0568-21 4 mm, 21.5 cm



Rhinology
Septum elevator, acc. to Roger

Material: Stainless steel

Other Sizes:
024-0572-19 : 4 mm, 20 cm



Rhinology
Elevator, bayonet-shape

Material: Stainless steel

Other Sizes:
024-0579-22 : 4 mm, 21.5 cm



Rhinology
Septum elevator, acc. to Cottle

Material: Stainless steel

Other Sizes:
024-0581-22 : 3.7 mm, 23 cm



Rhinology
Elevator, acc. to Masing

Material: Stainless steel

Other Sizes:
024-0583-21 : 2 mm, 19.5 cm



Rhinology
Elevator, acc. to Cottle

Material: Stainless steel

Other Sizes:
024-0584-21 : 4.5 mm, 22 cm



Rhinology
Periosteal elevator, acc. to Joseph

Material: Stainless steel

Other Sizes:
024-0585-16 : 6.5 mm, 18 cm



Rhinology
Septum Chisel, acc. to Freer, curved

Material: Stainless steel

Other Sizes:
024-0593-16 : 4 mm, 16,5 cm



Rhinology
Septum Chisel, acc. to Freer, straight

Material: Stainless steel

Other Sizes:
024-0594-16 : 4 mm, 16.5cm

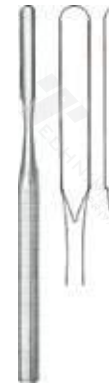

Rhinology
Septum Chisel, acc. to Freer

Material: Stainless steel

Other Sizes:
024-0595-15 : 6 mm, 16 cm



Rhinology
Gouge, acc. to Ballenger, straight

Material: Stainless steel

Other Sizes:
024-0597-02 : 2 mm, 15 cm
024-0597-04 : 4 mm, 15 cm
024-0597-06 : 6 mm, 15 cm
024-0597-08 : 8 mm, 15 cm



Rhinology
Septum gouge, acc. to Killian

Material: Stainless steel

Other Sizes:
024-0601-16 : 5 mm, 16 cm



Rhinology
Gouge, acc. to Killian-Claus

Material: Stainless steel

Other Sizes:
024-0605-16 : 5 mm, 16 cm



Rhinology
Osteotome, acc. to Cottle, graduated

Material: Stainless steel

Other Sizes:

024-0606-04	4 mm, 18.5 cm
024-0606-07	7 mm, 18.5 cm
024-0606-09	9 mm, 18.5 cm
024-0606-12	12 mm, 18.5 cm



Rhinology
Osteotome, acc. to Cottle, curved

Material: Stainless steel

Other Sizes:

024-0607-06	6 mm, 18.5 cm
-------------	---------------



Rhinology
Osteotome, acc. to Cottle

Material: Stainless steel

Other Sizes:

024-0608-02	2 mm, 18.5 cm
024-0608-04	4 mm, 18.5 cm
024-0608-07	7 mm, 18.5 cm
024-0608-09	9 mm, 18.5 cm
024-0608-12	12 mm, 18.5 cm



Rhinology
Osteotome, acc. to Cottle, angled

Material: Stainless steel

Other Sizes:

024-0609-06	6 mm, 18.5 cm
-------------	---------------



Rhinology
Osteotome, acc. to Cottle, graduated

Material: Stainless steel

Other Sizes:

024-0610-16	16 mm, 18.5 cm
-------------	----------------



Rhinology
Osteotome, acc. to Cottle

Material: Stainless steel

Other Sizes:

024-0612-16	16 mm, 18.5 cm
-------------	----------------



Rhinology
Osteotome, acc. to Rubin

Material: Stainless steel

Other Sizes:

024-0616-10	10 mm , 18.5 cm
024-0616-12	12 mm , 18.5 cm
024-0616-14	14 mm , 18.5 cm



Rhinology
Chisel, acc. to Walter

Material: Stainless steel

Other Sizes:

024-0620-03	3 mm , 19 cm
024-0620-04	4.5 mm , 19 cm



Rhinology
Osteotome, acc. to Walter

Material: Stainless steel

Other Sizes:

024-0622-03	3 mm , 19 cm
024-0622-04	4 mm , 19 cm
024-0622-07	7 mm , 19 cm
024-0622-09	9 mm , 19 cm
024-0622-12	12 mm , 19 cm



Rhinology
Chisel, acc. to Fomon, with guide

Material: Stainless steel

Other Sizes:

024-0623-04	4 mm , 16 cm
024-0623-05	5 mm , 16 cm
024-0623-06	6 mm , 16 cm
024-0623-07	7 mm , 16 cm



Rhinology
Osteotome, acc. to Cinelli

Material: Stainless steel

Other Sizes:

024-0624-10	10 mm , 16 cm
024-0624-12	12 mm , 16 cm
024-0624-14	14 mm , 16 cm
024-0624-16	16 mm , 16 cm



Rhinology
Osteotome, acc. to Neivert-Anderson, right

Material: Stainless steel

Other Sizes:

024-0625-01	7 mm , 20.5 cm
-------------	----------------



Rhinology
Osteotome, acc. to Neivert-Anderson, left

Material: Stainless steel

Other Sizes:
024-0625-02 : 7 mm, 20.5 cm

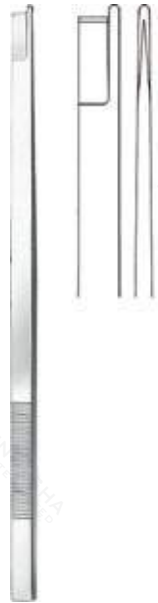

Rhinology
Osteotome, acc. to Neivert-Anderson, straight

Material: Stainless steel

Other Sizes:
024-0625-03 : 7 mm, 20.5 cm



Rhinology
N/A

Material: Stainless steel

Other Sizes:
024-0626-01 : 15 cm, 1 mm
024-0626-02 : 15 cm, 2 mm
024-0626-03 : 15 cm, 3 mm
024-0626-04 : 15 cm, 4 mm
024-0626-05 : 15 cm, 5 mm
024-0626-06 : 15 cm, 6 mm
024-0626-07 : 15 cm, 7 mm
024-0626-08 : 15 cm, 8 mm
024-0626-09 : 15 cm, 9 mm
024-0626-10 : 15 cm, 10 mm
024-0626-11 : 15 cm, 11 mm
024-0626-12 : 15 cm, 12 mm



Rhinology
Nasal Chisel, acc. to Silver, straight

Material: Stainless steel

Other Sizes:
024-0628-01 : 5 mm, 18 cm



Rhinology
Nasal Chisel, acc. to Silver, right

Material: Stainless steel

Other Sizes:
024-0628-02 : 5 mm, 18 cm



Rhinology
Nasal Chisel, acc. to Silver, left

Material: Stainless steel

Other Sizes:
024-0628-03 : 5 mm, 18 cm



Rhinology

Osteotome, acc. to Parkes, straight

Material: Stainless steel

Other Sizes:

024-0629-01 : 16 cm



Rhinology

Nasal saw, acc. to Joseph, angled left

Material: Stainless steel

Other Sizes:

024-0632-20 : 17 cm



Rhinology

Nasal saw, acc. to Joseph, angled right

Material: Stainless steel

Other Sizes:

024-0634-20 : 17 cm



Rhinology

Nasal saw, acc. to Joseph, straight

Material: Stainless steel

Other Sizes:

024-0649-00 : 19 cm



Rhinology

Nasal saw, acc. to Joseph, bayonet-shape, left

Material: Stainless steel

Other Sizes:

024-0649-01 : 19 cm



Rhinology

Nasal saw, acc. to Joseph, bayonet-shape, right

Material: Stainless steel

Other Sizes:

024-0649-02 : 19 cm



Rhinology
Application Handle, acc. to Cottle

Material: Stainless steel

Other Sizes:
024-0650-01 : 12 cm



Rhinology
Guide attachment, acc. to Cottle, for 024-0650-01

Material: Stainless steel

Other Sizes:
024-0650-02 : N/A



Rhinology
Cartilage crusher, acc. to Cottle, with clip

Material: Stainless steel

Other Sizes:
024-0652-00 : 65 x 30 x 30 mm



Rhinology
Nasal rasp, acc. to Maltz, push

Material: Stainless steel

Other Sizes:
024-0656-01 : 34 x 7 mm, 17 cm



Rhinology
Nasal rasp, acc. to Maltz, draw 34 x 7 mm

Material: Stainless steel

Other Sizes:
024-0656-02 : 17 cm



Rhinology
Bone file, acc. to Joseph, fine

Material: Stainless steel

Other Sizes:
024-0658-01 : 16 cm



Rhinology

Nasal rasp, acc. to Cottle

Material: Stainless steel

Other Sizes:

024-0670-21 : 30 x 8 mm, 21 cm



Rhinology

Glabella rasp, acc. to AufriCht, push

Material: Stainless steel

Other Sizes:

024-0671-21 : 21 cm



Rhinology

Glabellum rasp, acc. to AufriCht, draw

Material: Stainless steel

Other Sizes:

024-0673-21 : 21 cm



Rhinology

Nasal rasp, acc. to Lewis, fine

Material: Stainless steel

Other Sizes:

024-0674-18 : 15 x 8 mm, 19 cm



Rhinology

Nasal rasp, acc. to Lewis, fine

Material: Stainless steel

Other Sizes:

024-0676-18 : 15 x 8 mm, 19 cm



Rhinology

Nasal rasp, TC Gold, acc. to Maltz

Material: Stainless steel

Other Sizes:

024-0680-01 : 21 cm
 024-0680-02 : 21 cm
 024-0680-03 : 21 cm
 024-0680-04 : 21 cm
 024-0680-05 : 21 cm
 024-0680-06 : 21 cm
 024-0680-07 : 21 cm
 024-0680-08 : 21 cm
 024-0680-09 : 21 cm
 024-0680-10 : 21 cm



Rhinology

Nasal rasp, TC Gold, acc. to Fomon

Material: Stainless steel

Other Sizes:

024-0682-01	30 x 8 mm, 20.5 cm
024-0682-02	40 x 7 mm, 20.5 cm
024-0682-03	40 x 7 mm, 20.5 cm
024-0682-04	40 x 7 mm, 20.5 cm
024-0682-05	40 x 7 mm, 20.5 cm
024-0682-06	40 x 7 mm, 20.5 cm



Rhinology

Mucous hooklet, acc. to Joseph, sharp

Material: Stainless steel

Other Sizes:

024-0684-15	15.5 cm
-------------	---------



Rhinology

Tenaculum hooklet, acc. to Cottle, sharp

Material: Stainless steel

Other Sizes:

024-0686-16	17 cm
-------------	-------



Rhinology

Tenaculum hooklet, acc. to Cottle, sharp, 180

Material: Stainless steel

Other Sizes:

024-0687-17	17 cm
-------------	-------



Rhinology

Hooklet, acc. to Cottle, sharp

Material: Stainless steel

Other Sizes:

024-0688-01	3.7 mm, 14.5 cm
024-0688-02	4.0 mm, 14.5 cm
024-0688-03	4.2 mm, 14.5 cm



Rhinology

Alar retractor, acc. to Lange, blunt

Material: Stainless steel

Other Sizes:

024-0692-22	23 cm
-------------	-------



Rhinology

Alar retractor, acc. to Fomon blunt

Material: Stainless steel

Other Sizes:

024-0694-17 : 17 cm



Rhinology

Nasal retractor, acc. to AufriCht

Material: Stainless steel

Other Sizes:

024-0697-19 : 45 x 11 mm, 19 cm



Rhinology

Alar retractor, acc. to Kilner, sharp

Material: Stainless steel

Other Sizes:

024-0698-10 : 8 cm



Rhinology

Retractor, acc. to Converse

Material: Stainless steel

Other Sizes:

024-0699-11 : 44 x 11 mm, 10.5 cm



Rhinology

Alar retractor, sharp, double

Material: Stainless steel

Other Sizes:

024-0700-12 : 11.5 cm



Rhinology

Skin hooklet, 2 prongs, sharp

Material: Stainless steel

Other Sizes:

024-0702-15 : 15 cm



Rhinology
Skin hooklet, acc. to Joseph, 2 prongs

Material: Stainless steel

Other Sizes:
024-0704-02 : 2 mm, 16 cm
024-0704-05 : 5 mm, 16 cm
024-0704-07 : 7 mm, 16 cm
024-0704-10 : 10 mm, 16 cm



Rhinology
Alar retractor, acc. to Fomon, blunt, 2 prongs

Material: Stainless steel

Other Sizes:
024-0706-16 : 16 cm



Rhinology
Retractor, acc. to Cottle-Neivert, with groove

Material: Stainless steel

Other Sizes:
024-0707-20 : 19.5 cm



Rhinology
Hooklet, sharp, 2 prongs

Material: Stainless steel

Other Sizes:
024-0708-14 : 14.5 cm



Rhinology
Hooklet, blunt/sharp, 2 prongs

Material: Stainless steel

Other Sizes:
024-0709-01 : 14.5 cm



Rhinology
Hooklet, sharp/blunt, 2 prongs

Material: Stainless steel

Other Sizes:
024-0709-02 : 14.5 cm



Rhinology
Hooklet, acc. to Cottle, blunt, 4 prongs

Material: Stainless steel

Other Sizes:
024-0710-14 : 14 cm

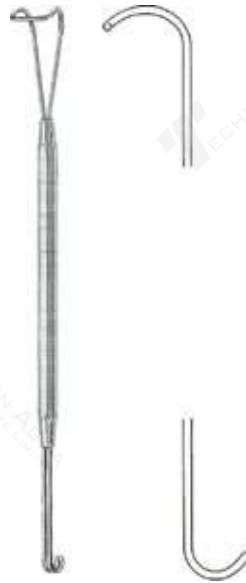

Rhinology
Retractor, acc. to Neivert, with groove

Material: Stainless steel

Other Sizes:
024-0712-16 : 17 cm



Rhinology
Alar retractor, acc. to Cottle

Material: Stainless steel

Other Sizes:
024-0713-15 : 14 cm



Rhinology
Alar retractor, acc. to Cottle, angled

Material: Stainless steel

Other Sizes:
024-0714-15 : 16 cm



Rhinology
Nasal retractor, acc. to AufriCht, double-ended

Material: Stainless steel

Other Sizes:
024-0715-14 : 12 cm



Rhinology
Septum forceps, acc. to Kressner, angled

Material: Stainless steel

Other Sizes:
024-0721-20 : 21 cm



Rhinology
Septum straightening forceps, straight

Material: Stainless steel

Other Sizes:
024-0724-01 : 23 cm



Rhinology
Septum straightening forceps, left

Material: Stainless steel

Other Sizes:
024-0724-02 : 23 cm



Rhinology
Septum straightening forceps, right

Material: Stainless steel

Other Sizes:
024-0724-03 : 23 cm



Rhinology
Septum straightening forceps, acc. to AsCh

Material: Stainless steel

Other Sizes:
024-0725-23 : 22.5 cm



Rhinology
Skin grasping forceps, acc. to Ogura

Material: Stainless steel

Other Sizes:
024-0728-11 : 4 mm, 11 cm



Rhinology
Skin grasping forceps, acc. to Cottle,
bayonet-shape

Material: Stainless steel

Other Sizes:
024-0731-14 : 14 cm



Rhinology

Columell forceps, acc. to Cottle

Material: Stainless steel

Other Sizes:

024-0732-10 : 12 mm, 11 cm



Rhinology

Curette, acc. to Faulkner, double-ended

Material: Stainless steel

Other Sizes:

024-0742-21 : 21 cm



Rhinology

Curette, acc. to Coakley, sharp

Material: Stainless steel

Other Sizes:

024-0748-01 : 17 cm
 024-0748-02 : 17 cm
 024-0748-03 : 17 cm
 024-0748-04 : 17 cm
 024-0748-05 : 17 cm
 024-0748-06 : 17 cm



Rhinology

Adenoid curette, acc. to Beckmann

Material: Stainless steel

Other Sizes:

024-0755-01 : 13 mm, 22.5 cm
 024-0755-02 : 15 mm, 22.5 cm
 024-0755-03 : 17 mm, 22.5 cm
 024-0755-04 : 19 mm, 22.5 cm
 024-0755-05 : 21 mm, 22.5 cm
 024-0755-06 : 23 mm, 22.5 cm



Rhinology

Adenoid curette, curved

Material: Stainless steel

Other Sizes:

024-0756-01 : 13 mm, 22 cm
 024-0756-02 : 15 mm, 22 cm
 024-0756-03 : 17 mm, 22 cm
 024-0756-04 : 19 mm, 22 cm
 024-0756-05 : 21 mm, 22 cm
 024-0756-06 : 23 mm, 22 cm



Rhinology

N/A

Material: Stainless steel

Other Sizes:

024-0759-01 : 22.5 cm, 16 mm
 024-0759-02 : 22.5 cm, 17 mm
 024-0759-03 : 22.5 cm, 18 mm
 024-0759-04 : 22.5 cm, 20 mm
 024-0759-05 : 22.5 cm, 21 mm



Rhinology
Antrum irrigating cannula, acc. to Eicken-Killian, curved

Material: Stainless steel

Other Sizes:
024-0814-30 Ø 3.0 mm, 14 cm
024-0816-30 Ø 3.0 mm, 14 cm

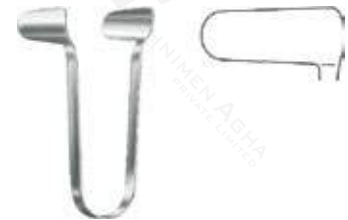

Rhinology
Nasal speculum, acc. to Goldsmith

Material: Stainless steel

Other Sizes:
024-0817-01 6.5 mm
024-0817-02 6.5 mm
024-0817-03 6.5 mm



Rhinology
Suction raspatory, acc. to Guilen, bayonet-shape

Material: Stainless steel

Other Sizes:
024-0840-20 19 cm



Rhinology
Obturator, for 024-0840-20

Material: Replacement part

Other Sizes:
024-0840-90 N/A



Rhinology
Nasal speculum, acc. to Hartmann-Halle

Material: Stainless steel

Other Sizes:
024-0845-01 15.5 cm
024-0845-02 15.5 cm
024-0845-03 15.5 cm



Rhinology
Nasal speculum, acc. to Martin, for Children

Material: Stainless steel

Other Sizes:
024-0848-13 : 13 cm



Rhinology
Nasal speculum, acc. to Martin, for Children

Material: Stainless steel

Other Sizes:
024-0849-13 : 12.5 cm



Rhinology
Nasal speculum, acc. to Tieck-Halle

Material: Stainless steel

Other Sizes:
024-0852-13 : 16 mm, 13 cm



Rhinology
Nasal speculum, acc. to Killian

Material: Stainless steel

Other Sizes:
024-0856-01 : 35 mm, 13 cm
024-0856-02 : 50 mm, 13 cm
024-0856-03 : 75 mm, 13 cm
024-0856-04 : 85 mm, 13 cm



Rhinology
Nasal speculum, Vienna-type

Material: Stainless steel

Other Sizes:
024-0858-14 : 30 mm, 13.5 cm



Rhinology
Nasal speculum, acc. to Cottle

Material: Stainless steel

Other Sizes:
024-0859-35 : 35 mm, 13.5 cm
024-0859-50 : 50 mm, 13.5 cm
024-0859-75 : 75 mm, 13.5 cm
024-0859-90 : 80 mm, 13.5 cm



Rhinology

Nasal speculum, acc. to Cottle, black

Material: Stainless steel

Other Sizes:

024-0861-45	45 mm, 13.5 cm
024-0861-75	75 mm, 14 cm



Rhinology

Nasal polypus snare, acc. to Krause

Material: Stainless steel

Other Sizes:

024-0885-26	26 cm
-------------	-------



Rhinology

Nasal polypus snare, acc. to Krause-Voss

Material: Stainless steel

Other Sizes:

024-0887-26	26 cm
-------------	-------



Rhinology

Snare wire, Ø 0.3 mm, bundle of 12 pieces (coil of 10 m)

Material: steel 18/8 martinit, antimagnetic, stainless, acid-resistant

Other Sizes:

024-0899-12	10.5 cm
-------------	---------



Rhinology

Snare wire, coil of 10 m

Material: Stainless steel

Other Sizes:

024-0898-30	Ø 0.3 mm
024-0898-40	Ø 0.4 mm

ORAL MAXILLO

— RANGE

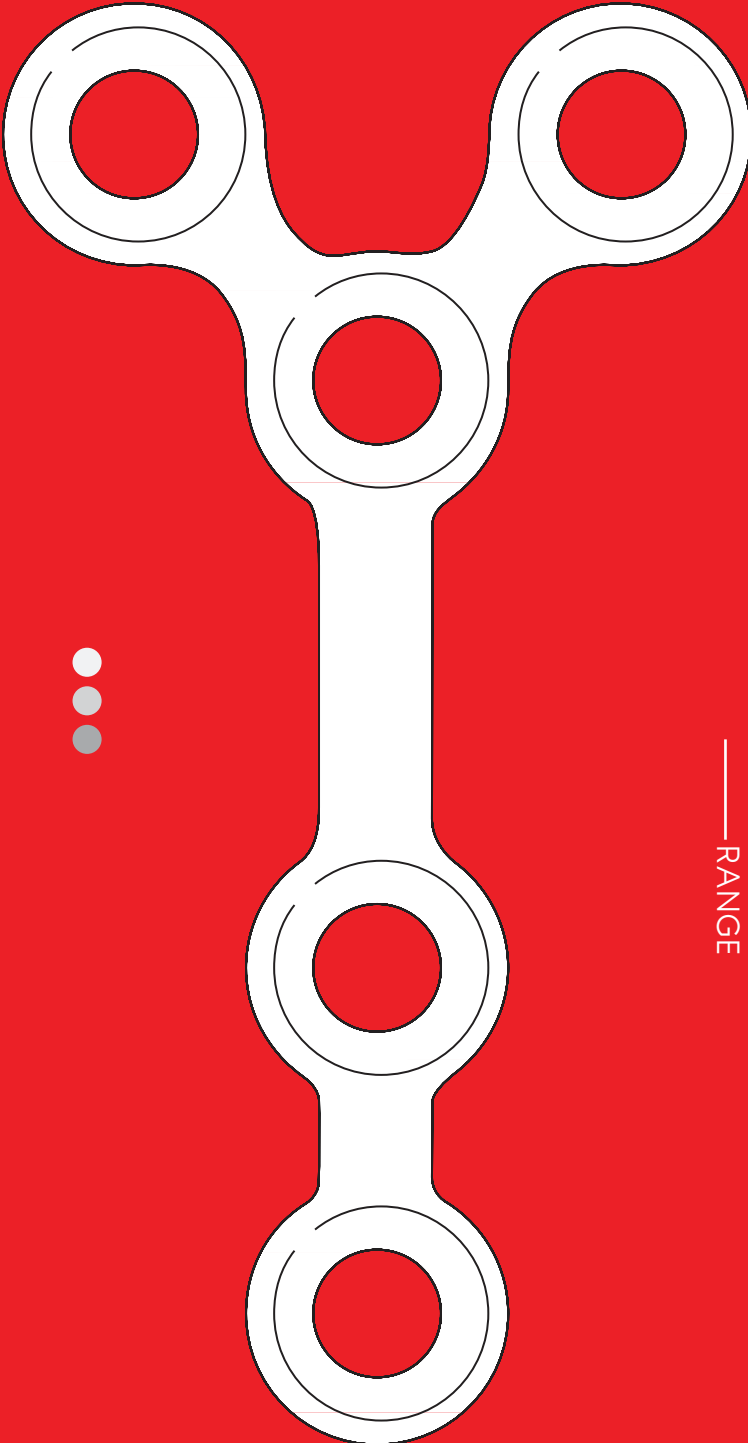

DISCOVER NOW

“Instruments for
surgical procedures”
Since 1970

ORAL MAXILLO



Oral Maxillo
N/A

Material: Stainless steel

Other Sizes:
025-0011-16 17 cm



Oral Maxillo
N/A

Material: Stainless steel

Other Sizes:
025-0012-16 11 cm



Oral Maxillo
N/A

Material: Stainless steel

Other Sizes:
025-0013-13 13 cm



Oral Maxillo
N/A

Material: Stainless steel

Other Sizes:
025-0014-00 3.0/7.0 mm



Oral Maxillo
N/A

Material: Stainless steel

Other Sizes:
025-0015-01 18 cm



Oral Maxillo
N/A

Material: Stainless steel

Other Sizes:
025-0015-02 17.5 cm
025-0015-03 18 cm
025-0015-04 18.5 cm
025-0015-06 19 cm



Oral Maxillo
N/A

Material: Stainless steel

Other Sizes:

025-0015-07	16 cm
025-0015-08	16 cm



Oral Maxillo
N/A

Material: Stainless steel

Other Sizes:

025-0015-09	15 cm
025-0015-10	17 cm



Oral Maxillo
N/A

Material: Stainless steel

Other Sizes:

025-0015-25	18.5 cm
-------------	---------



Oral Maxillo
N/A

Material: Stainless steel

Other Sizes:

025-0016-01	16.5 cm
-------------	---------



Oral Maxillo
N/A

Material: Stainless steel

Other Sizes:

025-0016-02	16.5 cm
-------------	---------

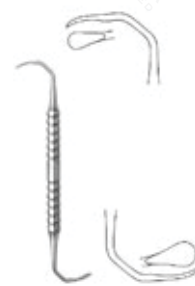

Oral Maxillo
N/A

Material: Stainless steel

Other Sizes:

025-0016-03	14 cm
-------------	-------

ORAL MAXILLO



Oral Maxillo
N/A

Material: Stainless steel

Other Sizes:
025-0016-04 : 15 cm



Oral Maxillo
N/A

Material: Stainless steel

Other Sizes:
025-0016-05 : 15 cm



Oral Maxillo
N/A

Material: Stainless steel

Other Sizes:
025-0100-17 : 17 cm



Oral Maxillo
N/A

Material: Stainless steel

Other Sizes:
025-0140-13 : 13 cm



Oral Maxillo
N/A

Material: Stainless steel

Other Sizes:
025-0161-11 : 11 cm



Oral Maxillo
N/A

Material: Stainless steel

Other Sizes:
025-0161-14 : 13 cm

ORAL MAXILLO



Oral Maxillo
N/A

Material: Stainless steel

Other Sizes:

025-0271-15 : 15 cm, 72x23 mm



Oral Maxillo
N/A

Material: Stainless steel

Other Sizes:

025-0275-15 : 14.5 cm, 85x24 mm



Oral Maxillo
N/A

Material: Stainless steel

Other Sizes:

025-0277-14 : 15 cm, 88x25mm



Oral Maxillo
N/A

Material: Stainless steel

Other Sizes:

025-0297-01 : 14 cm, 36 mm
025-0297-02 : 16 cm, 43 mm



Oral Maxillo
N/A

Material: Stainless steel

Other Sizes:

025-0352-15 : 15 cm



Oral Maxillo
N/A

Material: Stainless steel

Other Sizes:

025-0375-13 : 13.5 cm, 24/30 mm
025-0375-16 : 16 cm, 30/34 mm



Oral Maxillo
N/A

Material: Stainless steel

Other Sizes:
025-0385-19 : 19 cm, 19/15 mm



Oral Maxillo
N/A

Material: Stainless steel

Other Sizes:
025-0452-17 : 17 cm



Oral Maxillo
N/A

Material: Stainless steel

Other Sizes:
025-0467-17 : 15 cm

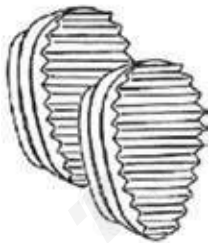

Oral Maxillo
N/A

Material: Stainless steel

Other Sizes:
025-0468-02 : 23 x 15 mm



Oral Maxillo
N/A

Material: Stainless steel

Other Sizes:
025-0603-40 : 21.5 cm, 43 x 11 mm
025-0603-55 : 21.5 cm, 57 x 11 mm
025-0603-80 : 21.5 cm, 83 x 16 mm



009-0545-10

Oral Maxillo
N/A

Material: Stainless steel

Other Sizes:
025-0605-22 : 22 cm

ORAL MAXILLO



Oral Maxillo
N/A

Material: Stainless steel

Other Sizes:
025-0607-22 : 22 cm



Oral Maxillo
N/A

Material: Stainless steel

Other Sizes:
025-0611-16 : 16.5 cm



Oral Maxillo
N/A

Material: Stainless steel

Other Sizes:
025-0613-08 : 17 cm, 8mm
025-0613-10 : 17 cm, 10mm



Oral Maxillo
N/A

Material: Stainless steel

Other Sizes:
025-0614-10 : 15 cm



Oral Maxillo
N/A

Material: Stainless steel

Other Sizes:
025-0614-20 : 15 cm



Oral Maxillo
N/A

Material: Stainless steel

Other Sizes:
025-0616-01 : 18.5 cm, 14 x 7 mm
025-0616-02 : 18.5 cm, 20 x 7mm



Oral Maxillo
N/A

Material: Stainless steel

Other Sizes:

025-0618-01	18 cm, 3 x 18mm
025-0618-02	18 cm, 3.5 x 23mm



Oral Maxillo
N/A

Material: Stainless steel

Other Sizes:

025-0630-06	17.5 cm, 6mm
025-0630-07	17.5 cm, 7mm
025-0630-09	17.5 cm, 9mm
025-0630-11	17.5 cm, 11mm



Oral Maxillo
N/A

Material: Stainless steel

Other Sizes:

025-0631-05	20.5 cm, 5mm
025-0631-07	20.5 cm, 7mm
025-0631-09	20.5 cm, 9mm



Oral Maxillo
N/A

Material: Stainless steel

Other Sizes:

025-0632-01	17.5 cm
025-0632-02	17.5 cm



Oral Maxillo
N/A

Material: Stainless steel

Other Sizes:

025-0640-21	20.5 cm
-------------	---------



Oral Maxillo
N/A

Material: Stainless steel

Other Sizes:

025-0642-21	20.5 cm
-------------	---------



Oral Maxillo
N/A

Material: Stainless steel

Other Sizes:

025-0700-01	22.5 cm
025-0700-02	22.5 cm
025-0700-03	22.5 cm



Oral Maxillo
N/A

Material: Stainless steel

Other Sizes:

025-0701-01	24 cm
025-0701-02	24 cm
025-0701-03	24 cm



Oral Maxillo
N/A

Material: Stainless steel

Other Sizes:

025-0711-21	20 cm
-------------	-------



Oral Maxillo
N/A

Material: Stainless steel

Other Sizes:

025-0713-21	21 cm
-------------	-------



Oral Maxillo
N/A

Material: Stainless steel

Other Sizes:

025-0715-19	20 cm
-------------	-------



Oral Maxillo
N/A

Material: Stainless steel

Other Sizes:

025-0718-01	18 cm
-------------	-------



Oral Maxillo
N/A

Material: Stainless steel

Other Sizes:
025-0718-02 : 18 cm



Oral Maxillo
N/A

Material: Stainless steel

Other Sizes:
025-0719-01 : 17.5 cm
025-0719-02 : 17.5 cm



Oral Maxillo
N/A

Material: Stainless steel

Other Sizes:
025-0720-01 : 13 cm



Oral Maxillo
N/A

Material: Stainless steel

Other Sizes:
025-0720-13 : 13 cm



Oral Maxillo
N/A

Material: Stainless steel

Other Sizes:
025-0781-00 : 20.5 cm, 6mm
025-0781-01 : 20.5 cm, 8mm



Oral Maxillo
N/A

Material: Stainless steel

Other Sizes:
025-0783-01 : 17.5 cm



Oral Maxillo
N/A

Material: Stainless steel

Other Sizes:

025-0786-04	16 cm, 4mm
025-0786-06	16 cm, 6mm
025-0786-08	16 cm, 8mm
025-0786-10	16 cm, 10mm
025-0786-12	16 cm, 12mm
025-0786-14	16 cm, 14mm
025-0786-16	16 cm, 16mm



Oral Maxillo
N/A

Material: Stainless steel

Other Sizes:

025-0790-04	16.5 cm, 4mm
025-0790-06	16.5 cm, 6mm
025-0790-08	16.5 cm, 8mm



Oral Maxillo
N/A

Material: Stainless steel

Other Sizes:

025-0791-01	17 cm
025-0791-03	17 cm



Oral Maxillo
N/A

Material: Stainless steel

Other Sizes:

025-0796-04	18 cm, 4x1.2 mm
025-0796-06	18 cm, 6x1.2 mm
025-0796-08	18 cm, 8x1.2mm



Oral Maxillo
N/A

Material: Stainless steel

Other Sizes:

025-0797-04	18 cm, 4x1.2 mm
025-0797-06	18 cm, 6x1.2 mm



Oral Maxillo
N/A

Material: Stainless steel

Other Sizes:

025-0799-06	18 cm, 6x1.2 mm
025-0799-08	18 cm, 8x1.2 mm

ORAL MAXILLO



Oral Maxillo
N/A

Material: Stainless steel

Other Sizes:
025-0841-22 : 22 cm

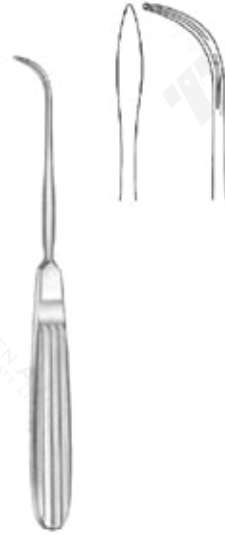

Oral Maxillo
N/A

Material: Stainless steel

Other Sizes:
025-0875-18 : 18.5 cm



Oral Maxillo
N/A

Material: Stainless steel

Other Sizes:
025-0881-07 : 17 cm, 7 mm
025-0881-10 : 17 cm, 10 mm



Oral Maxillo
N/A

Material: Stainless steel

Other Sizes:
025-0883-07 : 19 cm, 7 mm
025-0883-11 : 19 cm, 11 mm
025-0883-15 : 19 cm, 15 mm



Oral Maxillo
N/A

Material: Stainless steel

Other Sizes:
025-0885-18 : 18 cm



Oral Maxillo
N/A

Material: Stainless steel

Other Sizes:
025-0887-01 : 16 cm, 6x12 mm
025-0887-02 : 16.5 cm, 6x12 mm
025-0887-03 : 17 cm, 6x26 mm

ORAL MAXILLO



Oral Maxillo
N/A

Material: Stainless steel

Other Sizes:

025-0891-01	23 cm
025-0891-02	23 cm



Oral Maxillo
N/A

Material: Stainless steel

Other Sizes:

025-0893-16	16.5 cm
-------------	---------



Oral Maxillo
N/A

Material: Stainless steel

Other Sizes:

025-0895-08	18 cm
-------------	-------



Oral Maxillo
N/A

Material: Stainless steel

Other Sizes:

025-0899-06	23 cm, 6 mm
025-0899-08	23 cm, 8 mm



Oral Maxillo
N/A

Material: Stainless steel

Other Sizes:

25-0895-05	18 cm
------------	-------

TONSILLECTOMY

— RANGE



DISCOVER NOW

“Instruments for
surgical procedures”
Since 1970

TONSILLECTOMY



Tonsillectomy
Cleft palate retractor, short

Material: Stainless steel

Other Sizes:
025-0001-18 : 18.5 cm



Tonsillectomy
Cleft palate retractor, long

Material: Stainless steel

Other Sizes:
025-0003-18 : 18.5 cm



Tonsillectomy
Dissector, acc. to Salzer, angled, short

Material: Stainless steel

Other Sizes:
025-0011-18 : 18 cm



Tonsillectomy
Dissector, acc. to Salzer, angled, long

Material: Stainless steel

Other Sizes:
025-0013-18 : 18 cm



Tonsillectomy
Elevator acc. to Salzer, slightly curved

Material: Stainless steel

Other Sizes:
025-0021-18 : 18 cm



Tonsillectomy
Elevator acc. to Salzer, strongly curved

Material: Stainless steel

Other Sizes:
025-0023-17 : 18 cm

TONSILLECTOMY



Tonsillectomy
Elevator acc. to Salyer., angled,
graduated

Material: Stainless steel

Other Sizes:
025-0027-18 : 18 cm



Tonsillectomy
Palatal raspatory, curved left

Material: Stainless steel

Other Sizes:
026-0101-18 : 4 mm, 14 cm
026-0102-18 : 4 mm, 14 cm



Tonsillectomy
N/A

Material: Stainless steel

Other Sizes:
026-0137-21 : 20.5 cm



Tonsillectomy
N/A

Material: Stainless steel

Other Sizes:
026-0139-21 : 20.5 cm



Tonsillectomy
Tonsil knife, acc. to Fisher

Material: Stainless steel

Other Sizes:
026-0220-22 : 22.5 cm



Tonsillectomy
Tonsil knife, acc. to Bruenings

Material: Stainless steel

Other Sizes:
026-0228-23 : 23 cm

TONSILLECTOMY



Tonsillectomy

Tonsil knife/enucleator, acc. to Carpenter

Material: Stainless steel

Other Sizes:

026-0269-25 : 25 cm



Tonsillectomy

Dissector and retractor, acc. to Hurd

Material: Stainless steel

Other Sizes:

026-0281-22 : 22.5 cm



Tonsillectomy

Elevator, acc. to Henke

Material: Stainless steel

Other Sizes:

026-0289-23 : 11.5 x 5 mm, 24.5 cm
026-0291-23 : 16.5 x 5 mm, 24.5 cm



Tonsillectomy

Gauze packer, acc. to Luniatschek

Material: Stainless steel

Other Sizes:

026-0311-19 : 2 mm, 17.5 cm
026-0311-20 : 3 mm, 17.5 cm



Tonsillectomy

Gauze packer, acc. to Luniatschek, round Handle

Material: Stainless steel

Other Sizes:

026-0313-17 : 2 mm, 17.5 cm



Tonsillectomy

Tonsil grasping forceps, acc. to White, curved

Material: Stainless steel

Other Sizes:

026-0419-18 : 18 cm

TONSILLECTOMY



Tonsillectomy

Tonsil grasping forceps, acc. to Blohmke 1 x 2 teeth

Material: Stainless steel

Other Sizes:
026-0423-20 : 20 cm



Tonsillectomy

Tonsil forceps, acc. to Schnidt, curved

Material: Stainless steel

Other Sizes:
026-0443-19 : 19 cm



Tonsillectomy

Tonsil forceps, acc. to Schnidt, curved

Material: Stainless steel

Other Sizes:
026-0445-19 : 18.5 cm



Tonsillectomy

Tonsil forceps, acc. to Schnidt, curved

Material: Stainless steel

Other Sizes:
026-0447-19 : 19 cm



Tonsillectomy

Tonsil forceps, acc. to Schnidt, curved

Material: Stainless steel

Other Sizes:
026-0449-19 : 18.5 cm



Tonsillectomy

Tonsil snare, acc. to Eve, without ratchet

Material: Stainless steel

Other Sizes:
026-0500-28 : 28.5 cm

TONSILLECTOMY



Tonsillectomy
Tonsil snare, acc. to Bruenings

Material: Stainless steel

Other Sizes:
026-0506-28 : 29 cm

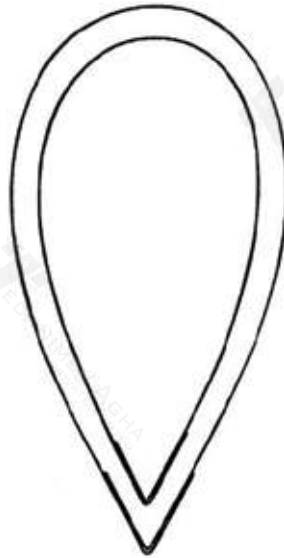

Tonsillectomy
Snare loop for tonsils

Material: Stainless steel

Other Sizes:
026-0511-40 : 40 x 0.3 mm
026-0511-50 : 50 x 0.3 mm



Tonsillectomy
Snare wire, bundle of 100 pieces

Material: Stainless steel

Other Sizes:
026-0513-01 : Ø 0.3 mm



Tonsillectomy
Tonsil snare, acc. to Tyding, with 1 TIP

Material: Stainless steel

Other Sizes:
026-0525-01 : N/A



Tonsillectomy
Tonsil forceps, acc. to Hartmann

Material: Stainless steel

Other Sizes:
026-0541-13 : Ø 13 mm, 12 cm
026-0541-15 : Ø 15 mm, 12 cm



Tonsillectomy
Universal Handle for laryngeal forceps,
acc. to Huber

Material: Stainless steel

Other Sizes:
026-0581-01 : N/A

TONSILLECTOMY



Tonsillectomy
Extension tube, straight

Material: Stainless steel

Other Sizes:	
026-0584-20	20 cm
026-0584-30	30 cm
026-0584-40	40 cm



Tonsillectomy
Extension tube, BRUENINGS, curved

Material: Stainless steel

Other Sizes:	
026-0587-20	20 cm



Tonsillectomy
Tip for laryngeal forceps, acc. to Fraenkel, serrated

Material: Stainless steel

Other Sizes:	
026-0600-01	N/A



Tonsillectomy
Tip for laryngeal forceps, acc. to Seiffert, coarse

Material: Stainless steel

Other Sizes:	
026-0604-01	N/A



Tonsillectomy
Tip for laryngeal forceps, acc. to Fraenkel, oval

Material: Stainless steel

Other Sizes:	
026-0608-01	N/A



Tonsillectomy
Tip for laryngeal forceps, acc. to Scheinmann, curved sideways

Material: octagonal handle

Other Sizes:	
026-0611-01	N/A

TONSILLECTOMY



Tonsillectomy

Tip for laryngeal forceps, acc. to Scheinmann, oval

Material: Stainless steel

Other Sizes:
026-0613-01 : N/A



Tonsillectomy

Tip for laryngeal forceps, acc. to Brünings

Material: Stainless steel

Other Sizes:
026-0616-02 : 3 mm
026-0616-03 : 4 mm



Tonsillectomy

Tip for laryngeal forceps, acc. to Brünings

Material: Stainless steel

Other Sizes:
026-0618-02 : N/A
026-0618-03 : N/A



Tonsillectomy

Tip for laryngoscopic forceps, acc. to Lange

Material: Stainless steel

Other Sizes:
026-0624-01 : N/A



Tonsillectomy

N/A

Material: Stainless steel

Other Sizes:
026-0628-01 : N/A
026-0628-02 : N/A



Tonsillectomy

Tip for laryngoscopic forceps, acc. to Krause, high arch

Material: Stainless steel

Other Sizes:
026-0632-01 : N/A

TONSILLECTOMY



Tonsillectomy

Tip for laryngoscopic forceps, acc. to Cordes, arch-shaped

Material: Stainless steel

Other Sizes:

026-0637-01	N/A
026-0637-02	N/A
026-0637-03	N/A
026-0637-04	N/A



Tonsillectomy

Tip for laryngoscopic forceps, acc. to Schuhmacher, triangled

Material: Stainless steel

Other Sizes:

026-0639-01	N/A
-------------	-----



Tonsillectomy

Tip for laryngoscopic forceps, acc. to Cordes, trapez-shaped

Material: Stainless steel

Other Sizes:

026-0643-01	N/A
026-0643-02	N/A



Tonsillectomy

Laryngeal mirror, with Handle

Material: steel 18/8 martinit, antimagnetic, stainless, acid-resistant

Other Sizes:

026-0781-08	8.5 mm Ø
026-0781-10	10.5 mm Ø
026-0781-12	12.5 mm Ø
026-0781-14	14.5 mm Ø
026-0781-16	16.5 mm Ø
026-0781-18	18.5 mm Ø
026-0781-20	20.5 mm Ø
026-0781-22	22.5 mm Ø
026-0781-24	24.5 mm Ø
026-0781-26	26.5 mm Ø
026-0781-28	28.5 mm Ø
026-0781-30	30.5 mm Ø



Tonsillectomy

Tip for laryngoscopic forceps, acc. to Cordes, round

Material: Stainless steel

Other Sizes:

026-0647-01	N/A
-------------	-----



Tonsillectomy

Tip for laryngoscopic forceps, acc. to Rosenberg, cap-shaped

Material: Stainless steel

Other Sizes:

026-0657-01	N/A
-------------	-----

TONSILLECTOMY



Tonsillectomy
Laryngeal mirror, Rhodium, with Handle

Material: all other, not specially marked material types

Other Sizes:

026-0782-08	8.5 mm Ø
026-0782-10	10.5 mm Ø
026-0782-12	12.5 mm Ø
026-0782-14	14.5 mm Ø
026-0782-16	16.5 mm Ø
026-0782-18	18.5 mm Ø
026-0782-20	20.5 mm Ø
026-0782-22	22.5 mm Ø
026-0782-24	24.5 mm Ø
026-0782-26	26.5 mm Ø
026-0782-28	28.5 mm Ø
026-0782-30	30.5 mm Ø



Tonsillectomy
Laryngeal mirror, without Handle

Material: all other, not specially marked material types

Other Sizes:

026-0785-08	8.5 mm Ø
026-0785-10	10.5 mm Ø
026-0785-12	12.5 mm Ø
026-0785-14	14.5 mm Ø
026-0785-16	16.5 mm Ø
026-0785-18	18.5 mm Ø
026-0785-20	20.5 mm Ø
026-0785-22	22.5 mm Ø
026-0785-24	24.5 mm Ø
026-0785-26	26.5 mm Ø
026-0785-28	28.5 mm Ø
026-0785-30	30.5 mm Ø



Tonsillectomy
Laryngeal mirror, Rhodium, without Handle

Material: all other, not specially marked material types

Other Sizes:

026-0786-08	8.5 mm Ø
026-0786-10	10.5 mm Ø
026-0786-12	12.5 mm Ø
026-0786-14	14.5 mm Ø
026-0786-16	16.5 mm Ø
026-0786-18	18.5 mm Ø
026-0786-20	20.5 mm Ø
026-0786-22	22.5 mm Ø
026-0786-24	24.5 mm Ø
026-0786-26	26.5 mm Ø
026-0786-28	28.5 mm Ø
026-0786-30	30.5 mm Ø



Tonsillectomy
Laryngeal mirror, acc. to Michel, moveable mirror

Material: chrome-plated

Other Sizes:

026-0789-12	Ø 12 mm
026-0789-14	Ø 14 mm
026-0789-16	Ø 16 mm
026-0789-18	Ø 18 mm



Tonsillectomy
Handle for laryngeal mirrors, smooth

Material: Stainless steel

Other Sizes:

026-0794-10	10 cm
026-0796-11	10 cm



Tonsillectomy
Handle for laryngeal mirrors

Material: Stainless steel

Other Sizes:

026-0798-12	12.5 cm
-------------	---------

TONSILLECTOMY



Tonsillectomy
Laryngeal polypus forceps, acc. to Jurasz, right

Material: Stainless steel

Other Sizes:
026-0814-01 23 cm



Tonsillectomy
Laryngeal polypus forceps, acc. to Jurasz, left

Material: Stainless steel

Other Sizes:
026-0814-02 23 cm



Tonsillectomy
Laryngeal polypus forceps, acc. to Jurasz, down

Material: Stainless steel

Other Sizes:
026-0814-03 23 cm



Tonsillectomy
Laryngeal polypus forceps, acc. to Jurasz, up

Material: Stainless steel

Other Sizes:
026-0814-04 23 cm

GRANIO MAXILLO

— RANGE

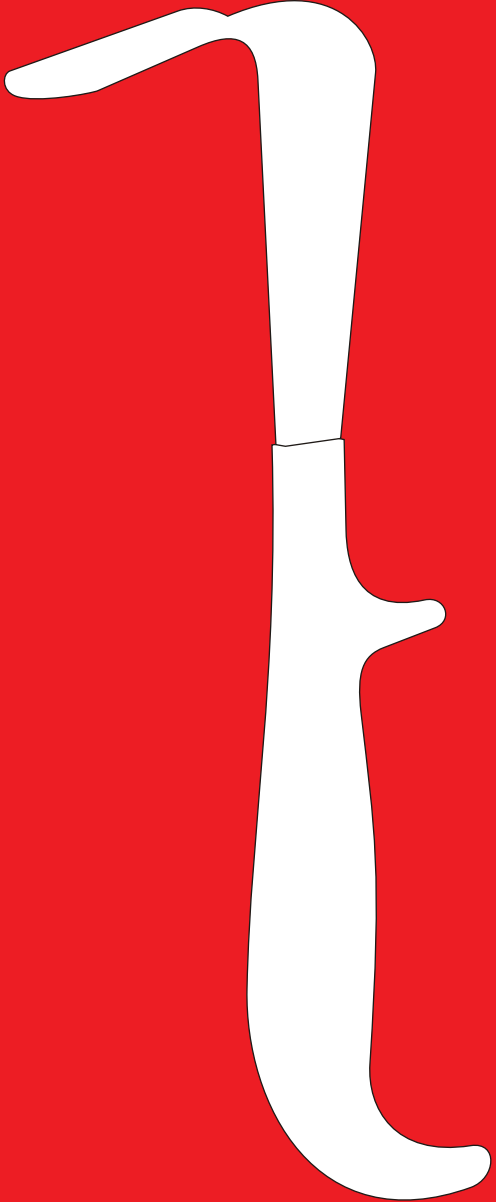

[DISCOVER NOW](#)

“Instruments for
surgical procedures”
Since 1970



Cranio Maxillo
N/A

Material: Stainless steel

Other Sizes:

027-0101-16	24 cm, 5x16 mm
027-0101-25	24 cm, 7x25 mm
027-0101-35	24 cm, 10x35 mm
027-0101-42	24 cm, 10x42 mm
027-0101-55	24 cm, 12x55 mm
027-0101-70	24 cm, 14x70 mm
027-0101-80	24 cm, 16x80 mm



Cranio Maxillo
N/A

Material: Stainless steel

Other Sizes:

027-0103-16	24 cm, 5x16 mm
027-0103-25	24 cm, 7x25 mm
027-0103-35	24 cm, 10x35 mm
027-0103-42	24 cm, 10x42 mm
027-0103-55	24 cm, 12x55 mm
027-0103-70	24 cm, 14x70 mm
027-0103-80	24 cm, 16x80 mm



Cranio Maxillo
N/A

Material: Stainless steel

Other Sizes:

027-0105-30	21 cm, 9/12 x 30mm
027-0105-45	21 cm, 9/12 x 45mm
027-0105-60	21 cm, 9/12 x 60mm



Cranio Maxillo
N/A

Material: Stainless steel

Other Sizes:

027-0107-22	24, 5cm
027-0109-22	24, 5cm

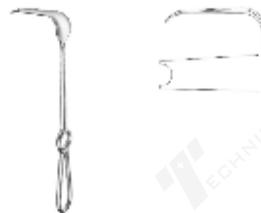

Cranio Maxillo
N/A

Material: Stainless steel

Other Sizes:

027-0111-22	24 cm, 15/22 x 70mm
-------------	---------------------



Cranio Maxillo
N/A

Material: Stainless steel

Other Sizes:

027-0113-22	24, 5 cm
-------------	----------



Cranio Maxillo
N/A

Material: Stainless steel

Other Sizes:

027-0121-08	8 mm
027-0121-10	10 mm



Cranio Maxillo
N/A

Material: Stainless steel

Other Sizes:

027-0130-06	18 cm, 6mm
027-0130-07	18 cm, 7mm
027-0130-09	18 cm, 9mm
027-0130-11	18 cm, 11mm



Cranio Maxillo
N/A

Material: Stainless steel

Other Sizes:

027-0132-06	18 cm, 6mm
027-0132-07	18 cm, 7mm
027-0132-09	18 cm, 9mm
027-0132-11	18 cm, 11mm



Cranio Maxillo
N/A

Material: Stainless steel

Other Sizes:

027-0135-21	21 cm, 6mm
-------------	------------



Cranio Maxillo
N/A

Material: Stainless steel

Other Sizes:

027-0137-21	21 cm, 6mm
-------------	------------



Cranio Maxillo
N/A

Material: Stainless steel

Other Sizes:

027-0140-01	18 cm
027-0140-02	18 cm



Cranio Maxillo
N/A

Material: Stainless steel

Other Sizes:
027-0150-01 : 17.5 cm, 7.5 mm



Cranio Maxillo
N/A

Material: Stainless steel

Other Sizes:
027-0150-02 : 17.5 cm, 11 mm



Cranio Maxillo
N/A

Material: Stainless steel

Other Sizes:
027-0152-05 : 20.5 cm, 5 mm
027-0152-07 : 20.5 cm, 7 mm
027-0152-09 : 20.5 cm, 9 mm



Cranio Maxillo
N/A

Material: Stainless steel

Other Sizes:
027-0166-08 : 23.5 cm, 8 mm
027-0166-11 : 23.5 cm, 11 mm



Cranio Maxillo
N/A

Material: Stainless steel

Other Sizes:
027-0168-03 : 15.5 cm, 3mm
027-0168-04 : 15.5 cm, 4mm
027-0168-06 : 15.5 cm, 6.5mm



Cranio Maxillo
N/A

Material: Stainless steel

Other Sizes:
027-0170-23 : 23 cm, 12 mm

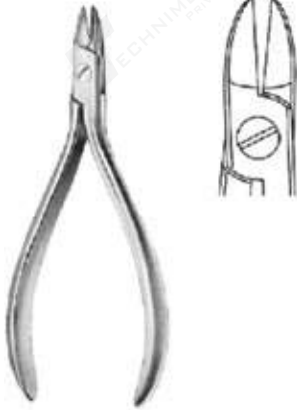

Cranio Maxillo
N/A

Material: Stainless steel

Other Sizes:
027-0190-11 : 12 cm



Cranio Maxillo
N/A

Material: Stainless steel

Other Sizes:
027-0250-19 : 19 cm



Cranio Maxillo
N/A

Material: Stainless steel

Other Sizes:
027-0252-13 : 13 cm



Cranio Maxillo
N/A

Material: Stainless steel

Other Sizes:
027-0270-02 : 16 cm, 2mm
027-0270-03 : 16 cm, 3mm
027-0270-05 : 16 cm, 5mm
027-0270-07 : 16 cm, 7mm
027-0270-10 : 16 cm, 10mm
027-0270-14 : 16 cm, 14mm
027-0270-16 : 16 cm, 16mm



Cranio Maxillo
flat nose plier, pointed

Material: Stainless steel

Other Sizes:
027-0271-05 : 16 cm, 5mm
027-0271-07 : 16 cm, 7mm
027-0271-10 : 16 cm, 10mm



Cranio Maxillo
N/A

Material: Stainless steel

Other Sizes:
027-0272-18 : 16 cm, 18mm



Cranio Maxillo
N/A

Material: Stainless steel

Other Sizes:
027-0273-10 : 18 cm, 10mm



Cranio Maxillo
N/A

Material: Stainless steel

Other Sizes:
027-0274-10 : 20 cm, 10mm
027-0274-15 : 20 cm, 15mm
027-0274-20 : 20 cm, 20mm
027-0274-30 : 20 cm, 30mm



Cranio Maxillo
N/A

Material: Stainless steel

Other Sizes:
027-0275-10 : 20 cm, 10mm
027-0275-15 : 20 cm, 15mm



Cranio Maxillo
N/A

Material: Stainless steel

Other Sizes:
027-0276-10 : 16 cm, 10mm
027-0276-15 : 16 cm, 15mm



Cranio Maxillo
N/A

Material: Stainless steel

Other Sizes:
027-0277-10 : 16 cm, 10mm
027-0277-15 : 16 cm, 15mm



Cranio Maxillo
N/A

Material: Stainless steel

Other Sizes:
027-0287-20 : 20.5 cm, 90x22 mm
027-0287-28 : 20.5 cm, 120x28 mm



Cranio Maxillo
N/A

Material: Stainless steel

Other Sizes:
027-0297-19 : 19.5 cm



Cranio Maxillo
N/A

Material: Stainless steel

Other Sizes:
027-0299-19 : 19 cm



Cranio Maxillo
N/A

Material: Stainless steel

Other Sizes:
027-0300-20 : 20.5 cm



Cranio Maxillo
N/A

Material: Stainless steel

Other Sizes:
027-0301-21 : 21.5 cm



Cranio Maxillo
N/A

Material: Stainless steel

Other Sizes:
027-0311-01 : 18.5 cm, 6mm

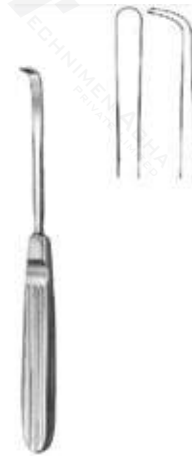

Cranio Maxillo
N/A

Material: Stainless steel

Other Sizes:
027-0311-02 : 18 cm, 6mm

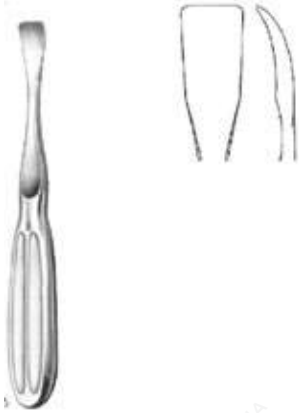

Cranio Maxillo
N/A

Material: Stainless steel

Other Sizes:

027-0313-01	20.5 cm, 12mm
027-0313-02	20.5 cm, 15mm



Cranio Maxillo
N/A

Material: Stainless steel

Other Sizes:

027-0336-10	14.5 cm, 10mm
027-0336-17	14.5 cm, 17.5mm
027-0336-20	14.5 cm, 20mm



Cranio Maxillo
N/A

Material: Stainless steel

Other Sizes:

027-0340-18	18.5 cm
-------------	---------



Cranio Maxillo
N/A

Material: Stainless steel

Other Sizes:

027-0341-18	18 cm, 10mm
-------------	-------------



Cranio Maxillo
N/A

Material: Stainless steel

Other Sizes:

027-0343-06	16.5 cm, 6mm
027-0343-09	16.5 cm, 9mm

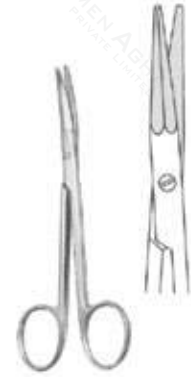

Cranio Maxillo
N/A

Material: Stainless steel

Other Sizes:

027-0351-13	13 cm
-------------	-------

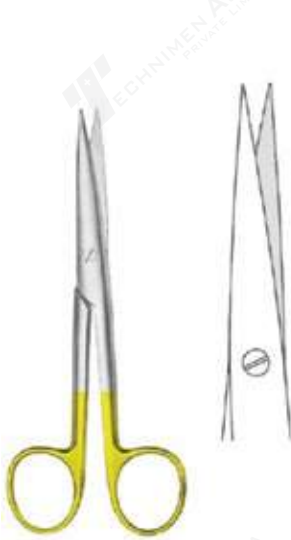

Cranio M
N/A

Material: Stainless steel

Other Sizes:
027-0352-14 : 14.5 cm

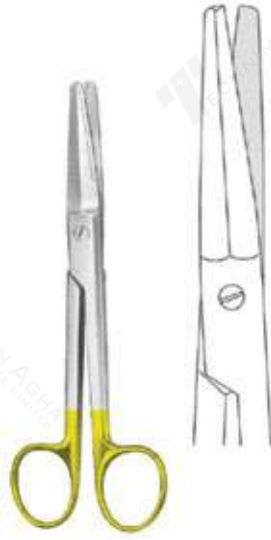

Cranio Maxillo
N/A

Material: Stainless steel

Other Sizes:
027-0354-16 : 16.5 cm



Cranio
N/A

Material: Stainless steel

Other Sizes:
027-0356-16 : 12 cm



Cranio Maxillo
N/A

Material: Stainless steel

Other Sizes:
027-0376-18 : 17.5 cm, 7mm

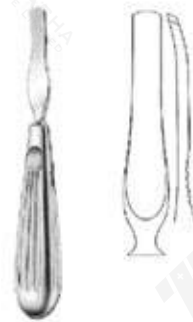

Cranio Maxillo
N/A

Material: Stainless steel

Other Sizes:
027-0400-07 : 15.5 cm, 7.5mm



Cranio Maxillo
N/A

Material: Stainless steel

Other Sizes:
027-0402-02 : 17 cm, 2mm
027-0402-03 : 17 cm, 3.5mm
027-0402-05 : 17 cm, 5mm



Cranio Maxillo
N/A

Material: Stainless steel

Other Sizes:

028-0440-04	18.5 cm, 4mm
028-0440-06	18.5 cm, 6mm
028-0440-08	18.5 cm, 8mm



Cranio Maxillo
N/A

Material: Stainless steel

Other Sizes:

028-0441-06	18.5 cm, 6mm
-------------	--------------



Cranio Maxillo
N/A

Material: Stainless steel

Other Sizes:

028-0446-19	19 cm
-------------	-------



Cranio Maxillo
N/A

Material: Stainless steel

Other Sizes:

028-0465-18	18 cm, 6.5mm
-------------	--------------



Cranio Maxillo
N/A

Material: Stainless steel

Other Sizes:

028-0450-17	17 cm
-------------	-------



Cranio Maxillo
N/A

Material: Stainless steel

Other Sizes:

028-0453-18	18 cm
-------------	-------

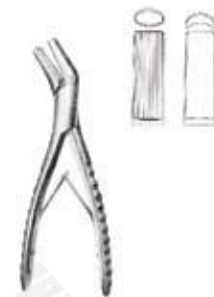

Cranio Maxillo
N/A

Material: Stainless steel

Other Sizes:

028-0471-18	18 cm, 11mm
-------------	-------------

ASEPSIS

— RANGE

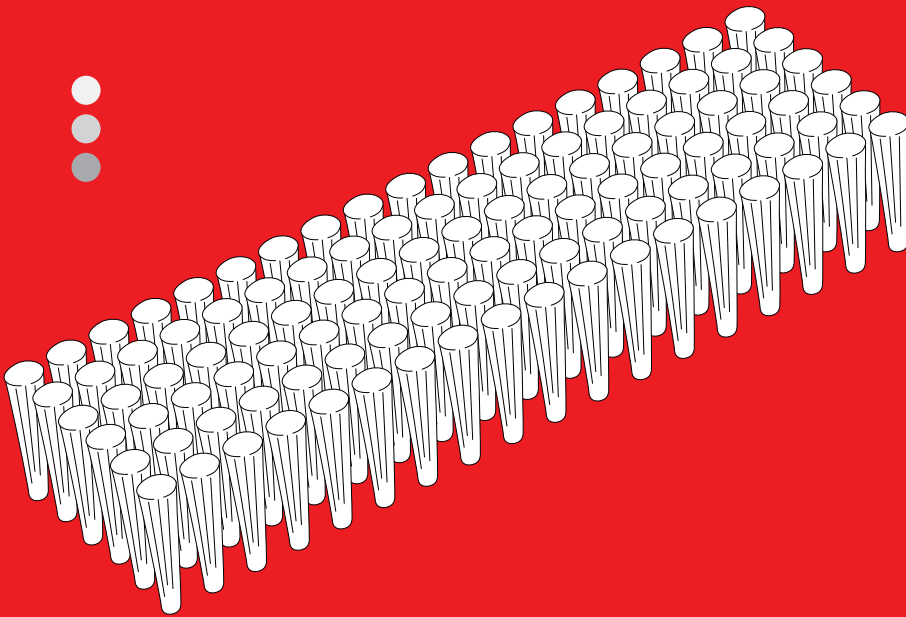

DISCOVER NOW

“Instruments for
surgical procedures”
Since 1970

ASEPSIS



Asepsis

N/A

Material: Stainless steel

Other Sizes:

029-0305-10 : 10.5 cm



Asepsis

N/A

Material: Stainless steel

Other Sizes:

029-0331-14 : 14 cm



Asepsis

N/A

Material: Stainless steel

Other Sizes:

029-0336-14 : 14 cm
029-0336-146 : 16 cm



Asepsis

N/A

Material: Stainless steel

Other Sizes:

029-0341-11 : 11.5 cm
029-0341-13 : 13 cm



Asepsis

N/A

Material: Stainless steel

Other Sizes:

029-0347-13 : 13 cm

ASEPSIS



Asepsis

N/A

Material: Stainless steel

Other Sizes:

029-0353-12 12 cm



Asepsis

N/A

Material: Stainless steel

Other Sizes:

029-0360-11 11 cm
029-0360-13 13 cm
029-0360-15 15 cm



Asepsis

N/A

Material: Stainless steel

Other Sizes:

029-0365-11 11 cm
029-0365-13 13 cm



Asepsis

N/A

Material: Stainless steel

Other Sizes:

029-0373-10 10.5 cm



Asepsis

N/A

Material: Stainless steel

Other Sizes:

029-0378-10 10.5 cm
029-0378-12 12 cm

ASEPSIS



Asepsis

N/A

Material: Stainless steel

Other Sizes:

029-0379-10	10.5 cm
029-0379-12	12 cm



Asepsis

Fingernail file

Material: Stainless steel

Other Sizes:

029-0386-10	9 cm
-------------	------



Asepsis

Fingernail file, hollow

Material: Stainless steel

Other Sizes:

029-0388-11	11 cm
-------------	-------

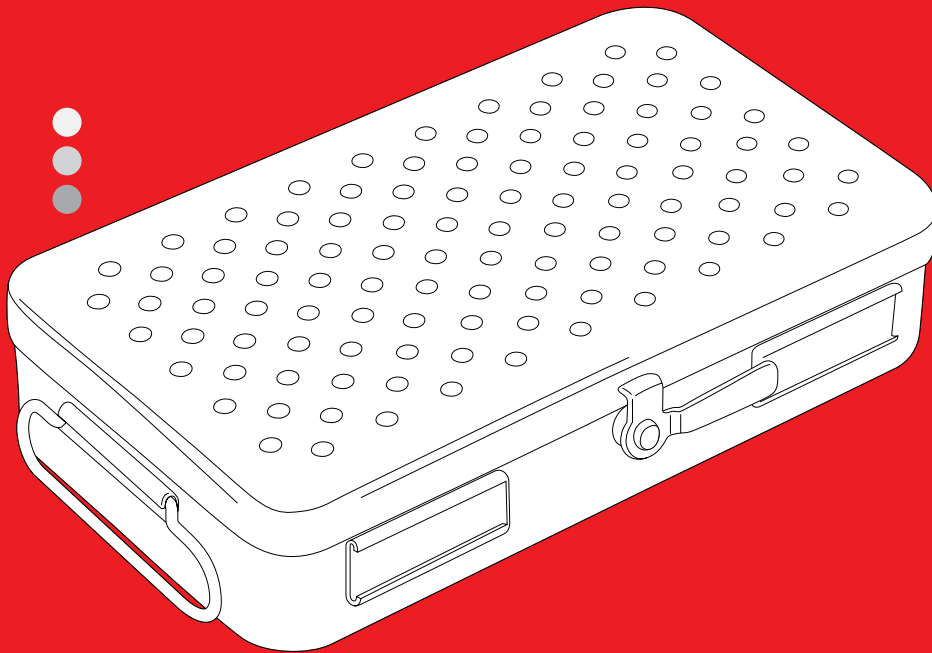

HYGIENE

— RANGE

DISCOVER NOW

“Instruments for
surgical procedures”
Since 1970



Hygiene
Sterilizing forceps, acc. to Cheatle

Material: Stainless steel

Other Sizes:
030-0085-27 27 cm



Hygiene
Sterilizing forceps

Material: Stainless steel

Other Sizes:
030-0091-30 30 cm



Hygiene
Needle case, perforated

Material: Stainless steel

Other Sizes:
030-0162-20 210 x 125 x 17 mm



Hygiene
Needle case, perforated

Material: steel 18/8 martinit,
antimagnetic, stainless, acid-resistant

Other Sizes:
030-0164-20 210 x 125 x 17 mm



Hygiene
Needle case, closed

Material: steel 18/8 martinit,
antimagnetic, stainless, acid-resistant

Other Sizes:	
030-0300-50	50 x 25 x 4.5 mm
030-0300-65	65 x 42 x 8 mm
030-0300-75	75 x 25 x 4.5 mm



Hygiene
Needle case, perforated

Material: steel 18/8 martinit,
antimagnetic, stainless, acid-resistant

Other Sizes:	
030-0302-50	50 x 25 x 4.5 mm
030-0302-65	65 x 42 x 8 mm
030-0302-75	75 x 25 x 4.5 mm



Hygiene
Needle case, round, CLOSED

Material: steel 18/8 martinit,
antimagnetic, stainless, acid-resistant

Other Sizes:	
030-0309-65	67 x 18 mm



Hygiene
Needle case, round, perforated, for 030-0309-65

Material: steel 18/8 martinit,
antimagnetic, stainless, acid-resistant

Other Sizes:	
030-0310-65	N/A

HYGIENE



Hygiene
Needle case, closed

Material: steel 18/8 martinit,
antimagnetic, stainless, acid-resistant

Other Sizes:
030-0335-01 150 x 95 x 13 mm



Hygiene
Needle case, perforated

Material: steel 18/8 martinit,
antimagnetic, stainless, acid-resistant

Other Sizes:
030-0335-02 150 x 95 x 13 mm



Hygiene
Needle case, perforated bottom

Material: steel 18/8 martinit,
antimagnetic, stainless, acid-resistant

Other Sizes:
030-0335-03 150 x 95 x 13 mm



Hygiene
needle case, perforated,

Material: steel 18/8 martinit,
antimagnetic, stainless, acid-resistant

Other Sizes:
030-0335-05 150 x 95 x 13 mm



Hygiene
needle case, closed

Material: steel 18/8 martinit,
antimagnetic, stainless, acid-resistant

Other Sizes:
030-0337-01 150 x 95 x 13 mm



Hygiene
needle case, perforated

Material: steel 18/8 martinit,
antimagnetic, stainless, acid-resistant

Other Sizes:
030-0337-02 150 x 95 x 13 mm



Hygiene
needle tray, perforated

Material: steel 18/8 martinit,
antimagnetic, stainless, acid-resistant

Other Sizes:
030-0340-02 150 x 95 x 11 mm



Hygiene
Instrument storage cup, H = 75

Material: steel 18/8 martinit,
antimagnetic, stainless, acid-resistant

Other Sizes:
030-0348-00 Ø 75 mm

HYGIENE



Hygiene
Dressing forceps, "Martin", with lid and jar

Material: steel 18/8 martinit, antimagnetic, stainless, acid-resistant

Other Sizes:
030-0358-25 25 cm



Hygiene
Sterilizing pin, with button end

Material: steel 18/8 martinit, antimagnetic, stainless, acid-resistant

Other Sizes:
030-0805-14 14 cm



Hygiene
Silicone bottom plate, for 030-0348-00

Material: steel 18/8 martinit, antimagnetic, stainless, acid-resistant

Other Sizes:
030-0348-01 N/A



Hygiene
Dressing forceps, "Martin", with lid and jar

Material: steel 18/8 martinit, antimagnetic, stainless, acid-resistant

Other Sizes:
030-0358-32 32 cm



Hygiene
Sterilizing pin, without button end

Material: steel 18/8 martinit, antimagnetic, stainless, acid-resistant

Other Sizes:
030-0808-14 14 cm

EXTRACTING FORCEPS

— RANGE

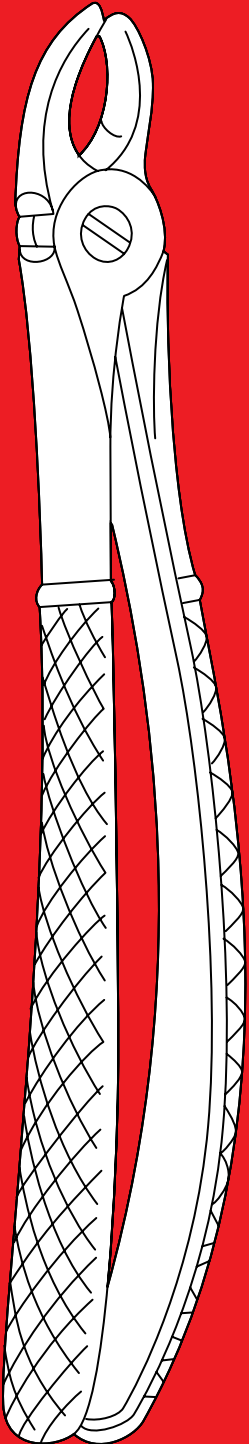

DISCOVER NOW

“Instruments for
surgical procedures”
Since 1970

EXTRACTING FORCEPS



Extracting Forceps
upper incisors and cuspids

Material: Stainless steel

Other Sizes:
031-0001-00 : N/A



Extracting Forceps
upper incisors and bicuspid

Material: Stainless steel

Other Sizes:
031-0002-00 : N/A



Extracting Forceps
Martin tooth grasping forceps, large

Material: Stainless steel

Other Sizes:
031-0002-05 : 18 cm



Extracting Forceps
Martin tooth grasping forceps, small

Material: Stainless steel

Other Sizes:
031-0002-10 : 17 cm



Extracting Forceps
N/A

Material: Stainless steel

Other Sizes:
031-0004-00 : N/A



Extracting Forceps
upper bicuspid

Material: Stainless steel

Other Sizes:
031-0007-00 : N/A

EXTRACTING FORCEPS



Extracting Forceps
lower bicuspid

Material: Stainless steel

Other Sizes:
031-0013-00 : N/A



Extracting Forceps
upper molars, right

Material: Stainless steel

Other Sizes:
031-0017-00 : N/A



Extracting Forceps
upper molars, left

Material: Stainless steel

Other Sizes:
031-0018-00 : N/A



Extracting Forceps
upper molars

Material: Stainless steel

Other Sizes:
031-0018-01 : N/A



Extracting Forceps
upper universal molar

Material: Stainless steel

Other Sizes:
031-0019-00 : N/A



Extracting Forceps
N/A

Material: Stainless steel

Other Sizes:
031-0022-00 : N/A

EXTRACTING FORCEPS



Extracting Forceps
right lower molars

Material: Stainless steel

Other Sizes:
031-0023-00 : N/A



Extracting Forceps
left lower molars

Material: Stainless steel

Other Sizes:
031-0024-00 : N/A



Extracting Forceps
upper incisors and roots

Material: Stainless steel

Other Sizes:
031-0029-00 : N/A



Extracting Forceps
upper and lower universal,
atraumatic tips

Material: Stainless steel

Other Sizes:
031-0041-00 : N/A



Extracting Forceps
upper universal, atraumatic tips

Material: Stainless steel

Other Sizes:
031-0041-01 : N/A



Extracting Forceps
lower incisors and cuspids,
atraumatic tips

Material: Stainless steel

Other Sizes:
031-0041-02 : N/A

EXTRACTING FORCEPS



Extracting Forceps
lower molars, TC serrated

Material: Stainless steel

Other Sizes:
031-0041-03 : N/A



Extracting Forceps
upper molars, TC serrated

Material: Stainless steel

Other Sizes:
031-0041-04 : N/A



Extracting Forceps
lower roots

Material: Stainless steel

Other Sizes:
031-0041-05 : N/A



Extracting Forceps
upper roots

Material: Stainless steel

Other Sizes:
031-0041-06 : N/A



Extracting Forceps
lower universal, atraumatic tips

Material: Stainless steel

Other Sizes:
031-0041-07 : N/A



Extracting Forceps
upper roots

Material: Stainless steel

Other Sizes:
031-0042-00 : N/A

EXTRACTING FORCEPS



Extracting Forceps
upper roots

Material: Stainless steel

Other Sizes:
031-0044-00 : N/A



Extracting Forceps
upper third molars

Material: Stainless steel

Other Sizes:
031-0067-00 : N/A
031-0067-01 : N/A



Extracting Forceps
lower molars

Material: Stainless steel

Other Sizes:
031-0073-00 : N/A



Extracting Forceps
lower incisors and roots

Material: Stainless steel

Other Sizes:
031-0074-00 : N/A
031-0074-06 : N/A
031-0074-07 : N/A



Extracting Forceps
lower third molars

Material: Stainless steel

Other Sizes:
031-0079-00 : N/A



Extracting Forceps
lower molars

Material: Stainless steel

Other Sizes:
031-0087-00 : N/A

EXTRACTING FORCEPS



Extracting Forceps
right upper molars

Material: Stainless steel

Other Sizes:
031-0089-00 : N/A



Extracting Forceps
left upper molars

Material: Stainless steel

Other Sizes:
031-0090-00 : N/A



Extracting Forceps
upper roots, small

Material: Stainless steel

Other Sizes:
031-0144-00 : N/A
031-0144-09 : N/A



Extracting Forceps
Exodontia Forceps Legend, upper
universal, standard

Material: Stainless steel

Other Sizes:
031-0150-00 : N/A



Extracting Forceps
Exodontia Forceps Legend, upper
universal, pediatric

Material: Stainless steel

Other Sizes:
031-0150-09 : N/A



Extracting Forceps
lower roots

Material: octagonal handle

Other Sizes:
031-0233-00 : N/A

EXTRACTING FORCEPS



Extracting Forceps
upper roots

Material: Stainless steel

Other Sizes:
031-0235-00 : N/A



Extracting Forceps
lower roots

Material: Stainless steel

Other Sizes:
031-0333-00 : N/A



Extracting Forceps
upper third molars

Material: Stainless steel

Other Sizes:
031-0367-01 : N/A



Extracting Forceps
lower molars

Material: Stainless steel

Other Sizes:
031-0373-00 : N/A



Extracting Forceps
lower incisors and roots serrated
narrow beak

Material: Stainless steel

Other Sizes:
031-0374-01 : N/A



Extracting Forceps
lower molars

Material: Stainless steel

Other Sizes:
031-0379-00 : N/A

EXTRACTING FORCEPS



Extracting Forceps
upper incisors and cuspids

Material: Stainless steel

Other Sizes:
031-0381-00 : N/A



Extracting Forceps
upper bicuspid and molars

Material: Stainless steel

Other Sizes:
031-0382-00 : N/A



Extracting Forceps
lower incisors, cuspids, bicuspid,
and roots

Material: Stainless steel

Other Sizes:
031-0383-00 : N/A



Extracting Forceps
lower molars

Material: Stainless steel

Other Sizes:
031-0384-00 : N/A



Extracting Forceps
left/right lower molars

Material: Stainless steel

Other Sizes:
031-0422-05 : N/A
031-0422-08 : N/A



Extracting Forceps
lower molars, pediatric

Material: Stainless steel

Other Sizes:
031-0613-09 : N/A

EXTRACTING FORCEPS



Extracting Forceps
lower molars, pediatric

Material: Stainless steel

Other Sizes:
031-0622-09 : N/A



Extracting Forceps
upper incisors and roots, pediatric

Material: Stainless steel

Other Sizes:
031-0630-09 : N/A



Extracting Forceps
lower roots and incisors, pediatric

Material: Stainless steel

Other Sizes:
031-0633-09 : N/A



Extracting Forceps
upper incisors and cuspids, pediatric

Material: Stainless steel

Other Sizes:
031-0637-00 : N/A



Extracting Forceps
upper molars, pediatric

Material: Stainless steel

Other Sizes:
031-0639-00 : N/A



Extracting Forceps
lower molars, pediatric

Material: Stainless steel

Other Sizes:
031-0640-00 : N/A

EXTRACTING FORCEPS



Extracting Forceps
upper molars, pediatric mini

Material: Stainless steel

Other Sizes:
031-0703-00 : N/A



Extracting Forceps
lower molars, pediatric mini

Material: Stainless steel

Other Sizes:
031-0706-00 : N/A



Extracting Forceps
lower molars and cuspids, pediatric mini

Material: Stainless steel

Other Sizes:
031-0707-00 : N/A



Extracting Forceps
upper incisors and cuspids, pediatric mini

Material: Stainless steel

Other Sizes:
031-0737-00 : N/A



Extracting Forceps
upper cuspids, pediatric mini

Material: Stainless steel

Other Sizes:
031-0739-00 : N/A



Extracting Forceps
lower molars, pediatric mini

Material: Stainless steel

Other Sizes:
031-0817-00 : N/A

EXTRACTING FORCEPS



Extracting Forceps
lower molars, pediatric mini

Material: Stainless steel

Other Sizes:
031-0823-09 N/A



Extracting Forceps
Exodontia Forceps Legend, upper
universal, pediatric mini

Material: Stainless steel

Other Sizes:
031-0850-09 N/A



Extracting Forceps
lower universal, pediatric mini

Material: Stainless steel

Other Sizes:
031-0851-09 N/A



Extracting Forceps
upper incisors, cuspids, and roots

Material: Stainless steel

Other Sizes:
032-0001-00 N/A



Extracting Forceps
Henahan, upper incisors and roots

Material: Stainless steel

Other Sizes:
032-0001-01 N/A



Extracting Forceps
upper incisors and bicuspid, serrated

Material: Stainless steel

Other Sizes:
032-0001-02 N/A

EXTRACTING FORCEPS



Extracting Forceps
Woodward, lower molars

Material: Stainless steel

Other Sizes:

032-0003-04	N/A
032-0003-09	N/A



Extracting Forceps
lower molars, splitting forceps

Material: Stainless steel

Other Sizes:

032-0006-00	N/A
-------------	-----



Extracting Forceps
upper molars

Material: Stainless steel

Other Sizes:

032-0010-04	N/A
-------------	-----

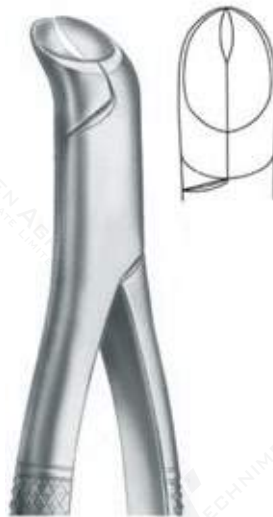

Extracting Forceps
lower molars, splitting forceps

Material: Stainless steel

Other Sizes:

032-0005-00	N/A
-------------	-----



Extracting Forceps
upper molars

Material: Stainless steel

Other Sizes:

032-0010-09	N/A
-------------	-----

EXTRACTING FORCEPS



Extracting Forceps
lower molars

Material: Stainless steel

Other Sizes:
032-0015-00 : N/A



Extracting Forceps
lower molars

Material: Stainless steel

Other Sizes:
032-0016-00 : N/A



Extracting Forceps
lower molars, pediatric

Material: Stainless steel

Other Sizes:
032-0016-09 : N/A



Extracting Forceps
lower molars

Material: Stainless steel

Other Sizes:
032-0017-00 : N/A



Extracting Forceps
Harris, left upper molars

Material: Stainless steel

Other Sizes:
032-0018-05 : N/A

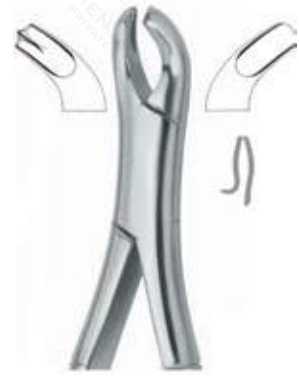

Extracting Forceps
Harris, right upper molars

Material: Stainless steel

Other Sizes:
032-0018-08 : N/A



Extracting Forceps
lower molars

Material: Stainless steel

Other Sizes:
032-0023-00 : N/A



Extracting Forceps
Clevedent, lower molars, large handle

Material: Stainless steel

Other Sizes:
032-0023-01 : N/A



Extracting Forceps
upper molars

Material: Stainless steel

Other Sizes:
032-0024-00 : N/A
032-0027-00 : N/A



Extracting Forceps
upper bicuspids and molars

Material: Stainless steel

Other Sizes:
032-0032-00 : N/A



Extracting Forceps
Parmlly, upper bicuspids, molars and roots

Material: Stainless steel

Other Sizes:
032-0032-01 : N/A



Extracting Forceps
left upper molars

Material: Stainless steel

Other Sizes:
032-0053-05 : N/A

EXTRACTING FORCEPS



Extracting Forceps
right upper molars

Material: Stainless steel

Other Sizes:
032-0053-08 : N/A



Extracting Forceps
upper universal

Material: Stainless steel

Other Sizes:
032-0062-00 : N/A



Extracting Forceps
upper incisors and roots

Material: Stainless steel

Other Sizes:
032-0065-00 : N/A



Extracting Forceps
Tomes, upper and lower roots

Material: Stainless steel

Other Sizes:
032-0069-00 : N/A



Extracting Forceps
left upper molars

Material: Stainless steel

Other Sizes:
032-0088-05 : N/A



Extracting Forceps
Nevius, right upper molars

Material: Stainless steel

Other Sizes:
032-0088-08 : N/A

EXTRACTING FORCEPS



Extracting Forceps
Kells, upper incisors, cuspids, and bicuspid

Material: Stainless steel

Other Sizes:
032-0099-03 : N/A



Extracting Forceps
Hull, upper and lower universal, pediatric

Material: Stainless steel

Other Sizes:
032-0101-00 : N/A



Extracting Forceps
upper and lower universal, pediatric

Material: Stainless steel

Other Sizes:
032-0101-08 : N/A



Extracting Forceps
lower incisors, bicuspid, cuspid and roots

Material: Stainless steel

Other Sizes:
032-0103-00 : N/A



Extracting Forceps
lower cuspids and molars

Material: Stainless steel

Other Sizes:
032-0104-33 : N/A



Extracting Forceps
lower molars, pediatric

Material: Stainless steel

Other Sizes:
032-0104-52 : N/A

EXTRACTING FORCEPS



Extracting Forceps
upper incisors and cuspids

Material: Stainless steel

Other Sizes:

032-0110-04	N/A
032-0110-09	N/A



Extracting Forceps
Cryer, upper universal, TC serrated

Material: Stainless steel

Other Sizes:

032-0150-00	N/A
-------------	-----



Extracting Forceps
Cryer, upper incisors, bicuspid, and roots

Material: Stainless steel

Other Sizes:

032-0150-01	N/A
-------------	-----



Extracting Forceps
upper incisors, bicuspid and roots, serrated

Material: Stainless steel

Other Sizes:

032-0150-02	N/A
-------------	-----



Extracting Forceps
upper universal, pediatric, serrated

Material: Stainless steel

Other Sizes:

032-0150-08	N/A
-------------	-----



Extracting Forceps
Cryer, Bicuspid, incisors and roots

Material: Stainless steel

Other Sizes:

032-0150-09	N/A
-------------	-----

EXTRACTING FORCEPS



Extracting Forceps
lower universal

Material: Stainless steel

Other Sizes:
032-0151-00 N/A



Extracting Forceps
lower universal

Material: Stainless steel

Other Sizes:
032-0151-01 N/A



Extracting Forceps
lower universal, serrated

Material: Stainless steel

Other Sizes:
032-0151-02 N/A



Extracting Forceps
lower universal pediatric, serrated

Material: Stainless steel

Other Sizes:
032-0151-08 N/A



Extracting Forceps
Cryer, lower universal, pediatric

Material: Stainless steel

Other Sizes:
032-0151-09 N/A



Extracting Forceps
lower incisors, bicuspid, and roots

Material: Stainless steel

Other Sizes:
032-0203-00 N/A

EXTRACTING FORCEPS



Extracting Forceps
upper third molars

Material: Stainless steel

Other Sizes:

032-0210-04	N/A
032-0210-09	N/A



Extracting Forceps
lower third molars

Material: Stainless steel

Other Sizes:

032-0217-00	N/A
-------------	-----



Extracting forceps
lower molars

Material: Stainless steel

Other Sizes:

032-0222-00	N/A
-------------	-----



Extracting Forceps
upper universal roots

Material: Stainless steel

Other Sizes:

032-0286-00	N/A
-------------	-----



Extra
Witzel, lower universal roots

Material: Stainless steel

Other Sizes:

032-0501-00	N/A
-------------	-----



Extracting Forceps
lower universal roots

Material: Stainless steel

Other Sizes:

032-0502-00	N/A
-------------	-----

DENTAL ELEVATORS

— RANGE

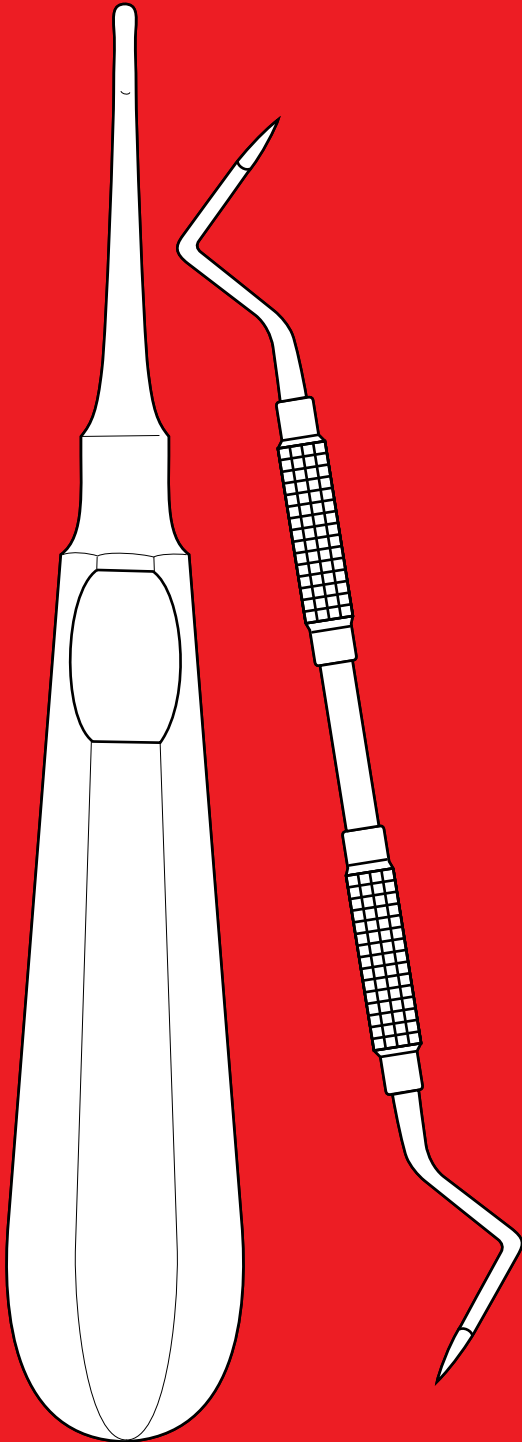

DISCOVER NOW

“Instruments for
surgical procedures”
Since 1970

DENTAL ELEVATORS



Dental Elevators
Beck elevator, serrated

Material: Stainless steel

Other Sizes:	
033-0000-85	2.8 mm tip
033-0000-86	3.5 mm tip
033-0000-87	4.0 mm tip



Dental Elevators
N/A

Material: Stainless steel

Other Sizes:	
033-0001-00	N/A
033-0002-00	N/A



Dental Elevators
Seldin

Material: Stainless steel

Other Sizes:	
033-0001-05	N/A
033-0001-08	N/A



Dental Elevators
Seldin

Material: Stainless steel

Other Sizes:	
033-0002-00	N/A



Dental Elevators
Cogswell

Material: Stainless steel

Other Sizes:	
033-0002-01	N/A



Dental Elevators
Kleinert Kutz, elevator, curette

Material: Stainless steel

Other Sizes:	
033-0002-97	N/A

DENTAL ELEVATORS



Dental Elevators
N/A

Material: Stainless steel

Other Sizes:
033-0003-00 N/A



Dental Elevators
Seldin

Material: Stainless steel

Other Sizes:
033-0003-01 N/A



Dental Elevators
Cryer

Material: Stainless steel

Other Sizes:
033-0003-02 N/A



Dental Elevators
Apical-Flohr

Material: Stainless steel

Other Sizes:
033-0004-00 N/A
033-0005-00 N/A



Dental Elevators
Seldin

Material: Stainless steel

Other Sizes:
033-0004-05 N/A
033-0004-08 N/A



Dental Elevators
periotome set includes blades
1-3 & handle

Material: Stainless steel

Other Sizes:
033-0004-80 N/A
033-0004-83 N/A
033-0004-82 N/A
033-0004-81 N/A

DENTAL ELEVATORS



Dental Elevators
periotome handle

Material: Stainless steel

Other Sizes:
033-0004-84 : N/A



Dental Elevators
serrated

Material: Stainless steel

Other Sizes:
033-0005-00 : N/A
033-0005-01 : N/A



Dental Elevators
Crane Pick

Material: Stainless steel

Other Sizes:
033-0006-00 : N/A



Dental Elevators
Cogswell B

Material: Stainless steel

Other Sizes:
033-0007-00 : N/A



Dental Elevators
Miller

Material: Stainless steel

Other Sizes:
033-0008-00 : N/A
033-0009-00 : N/A



Dental Elevators
Miller-Apexo

Material: Stainless steel

Other Sizes:
033-0010-00 : N/A
033-0011-00 : N/A

DENTAL ELEVATORS



Dental Elevators
short shaft, straight

Material: Stainless steel

Other Sizes: 033-0010-29 N/A



Dental Elevators
N/A

Material: Stainless steel

Other Sizes: 033-0011-00 N/A



Dental Elevators
N/A

Material: Stainless steel

Other Sizes: 033-0012-00 N/A



Dental Elevators
Cryer

Material: Stainless steel

Other Sizes: 033-0012-01 N/A



Dental Elevators
N/A

Material: Stainless steel

Other Sizes: 033-0013-00 N/A



Dental Elevators
N/A

Material: Stainless steel

Other Sizes: 033-0019-00 N/A

DENTAL ELEVATORS



Dental Elevators

N/A

Material: Stainless steel

Other Sizes:

033-0020-00 : N/A



Dental Elevators

N/A

Material: Stainless steel

Other Sizes:

033-0021-01 : N/A



Dental Elevators

N/A

Material: Stainless steel

Other Sizes:

033-0023-01 : N/A



Dental Elevators

N/A

Material: Stainless steel

Other Sizes:

033-0024-00 : N/A



Dental Elevators

Cryer

Material: Stainless steel

Other Sizes:

033-0027-00 : N/A

033-0028-00 : N/A



Dental Elevators

Cameron

Material: Stainless steel

Other Sizes:

033-0030-00 : N/A

DENTAL ELEVATORS



Dental Elevators
Skull breaker, acc. to VirChow

Material: Stainless steel

Other Sizes:
033-0031-00 N/A



Dental Elevators
N/A

Material: Stainless steel

Other Sizes:
033-0032-00 N/A



Dental Elevators
Seldin

Material: Stainless steel

Other Sizes:
033-0034-00 N/A
033-0034-09 N/A



Dental Elevators
Cryer

Material: Stainless steel

Other Sizes:
033-0039-00 N/A
033-0040-00 N/A



Dental Elevators
Cryer

Material: Stainless steel

Other Sizes:
033-0039-01 N/A
033-0040-01 N/A



Dental Elevators
N/A

Material: octagonal handle

Other Sizes:
033-0041-00 N/A

DENTAL ELEVATORS



Dental Elevators
N/A

Material: Stainless steel

Other Sizes:
033-0044-00 : N/A



Dental Elevators
N/A

Material: Stainless steel

Other Sizes:
033-0046-00 : N/A



Dental Elevators
Flohr straight

Material: Stainless steel

Other Sizes:
033-0046-01 : N/A



Dental Elevators
Barry

Material: Stainless steel

Other Sizes:
033-0050-00 : N/A
033-0050-01 : N/A



Dental Elevators
N/A

Material: Stainless steel

Other Sizes:
033-0051-00 : N/A



Dental Elevators
flat scoop

Material: Stainless steel

Other Sizes:
033-0051-16 : N/A

DENTAL ELEVATORS



Dental Elevators

N/A

Material: Stainless steel

Other Sizes:

033-0052-00 N/A



Dental Elevators

Apical, serrated

Material: Stainless steel

Other Sizes:

033-0077-00 N/A



Dental Elevators

N/A

Material: Stainless steel

Other Sizes:

033-0081-00 N/A



Dental Elevators

Apical

Material: Stainless steel

Other Sizes:

033-0081-01 N/A



Dental Elevators

Witzel, serrated

Material: Stainless steel

Other Sizes:

033-0092-00 N/A



Dental Elevators

N/A

Material: Stainless steel

Other Sizes:

033-0093-00 N/A

DENTAL ELEVATORS



Dental Elevators
elevator

Material: Stainless steel

Other Sizes:
033-0100-77 N/A



Dental Elevators
Brown Triangular, elevator

Material: Stainless steel

Other Sizes:
033-0102-54 N/A



Dental Elevators
hand pressure bone chisel

Material: Stainless steel

Other Sizes:
033-0103-91 N/A



Dental Elevators
Krogh

Material: Stainless steel

Other Sizes:
033-0104-31 N/A



Dental Elevators
N/A

Material: Stainless steel

Other Sizes:
033-0104-35 N/A



Dental Elevators
Clarizio, serrated

Material: Stainless steel

Other Sizes:
033-0105-94 N/A

DENTAL ELEVATORS



Dental Elevators
N/A

Material: Stainless steel

Other Sizes:
033-0190-00 N/A
033-0191-00 N/A



Dental Elevators
Apical

Material: Stainless steel

Other Sizes:
033-0301-00 N/A



Dental Elevators
N/A

Material: Stainless steel

Other Sizes:
033-0301-01 N/A



Dental Elevators
N/A

Material: Stainless steel

Other Sizes:
033-0302-00 N/A



Dental Elevators
Apical

Material: Stainless steel

Other Sizes:
033-0302-01 N/A
033-0303-01 N/A



Dental Elevators
N/A

Material: Stainless steel

Other Sizes:
033-0303-00 N/A

DENTAL ELEVATORS



Dental Elevators
Apical

Material: Stainless steel

Other Sizes:
033-0304-00 : N/A



Dental Elevators
Apical, serrated

Material: Stainless steel

Other Sizes:
033-0311-00 : N/A



Dental Elevators
N/A

Material: Stainless steel

Other Sizes:
033-0320-00 : N/A
033-0320-01 : N/A
033-0320-02 : N/A



Dental Elevators
Coleman

Material: Stainless steel

Other Sizes:
033-0405-01 : N/A



Dental Elevators
Coleman

Material: Stainless steel

Other Sizes:
033-0405-02 : N/A
033-0405-03 : N/A



Dental Elevators
Coupland

Material: Stainless steel

Other Sizes:
033-0415-01 : N/A
033-0415-02 : N/A
033-0415-04 : N/A

DENTAL ELEVATORS



Dental Elevators
Coupland, straight, slender handle

Material: Stainless steel

Other Sizes:

033-0415-01	N/A
033-0415-02	N/A
033-0415-03	N/A



Dental Elevators
Friedman

Material: Stainless steel

Other Sizes:

033-0505-01	N/A
-------------	-----



Dental Elevators
Friedman

Material: Stainless steel

Other Sizes:

033-0505-02	14 cm
033-0505-03	14 cm



Dental Elevators
Hylin

Material: Stainless steel

Other Sizes:

033-0508-01	N/A
033-0508-02	N/A



Dental Elevators
Hylin

Material: Stainless steel

Other Sizes:

033-0508-03	N/A
033-0508-04	N/A



Dental Elevators
Bein, square, 4 mm tip

Material: Stainless steel

Other Sizes:

033-0511-02	15 cm
-------------	-------

DENTAL ELEVATORS



Dental Elevators
Bein, round, 3 mm tip

Material: Stainless steel

Other Sizes:

033-0512-01	15 cm
033-0512-02	15 cm



Dental Elevators
Bein, sharp

Material: Stainless steel

Other Sizes:

033-0513-01	3 mm, 15 cm
033-0513-02	4 mm, 15 cm



Dental Elevators
Barry

Material: Stainless steel

Other Sizes:

033-0533-20	N/A
033-0533-21	N/A
033-0533-22	N/A
033-0533-23	N/A



Dental Elevators
Barry

Material: Stainless steel

Other Sizes:

033-0533-70	N/A
033-0533-71	N/A



Dental Elevators
Winter

Material: Stainless steel

Other Sizes:

033-0550-05	N/A
033-0550-08	N/A



Dental Elevators
Winter

Material: Stainless steel

Other Sizes:

033-0551-05	N/A
033-0551-08	N/A

DENTAL ELEVATORS



Dental Elevators
Winter

Material: Stainless steel

Other Sizes:

033-0552-05	N/A
033-0552-08	N/A



Dental Elevators
Winter

Material: Stainless steel

Other Sizes:

033-0553-05	N/A
033-0553-08	N/A



Dental Elevators
Winter

Material: Stainless steel

Other Sizes:

033-0554-05	N/A
033-0554-08	N/A



Dental Elevators
Lecluse

Material: Stainless steel

Other Sizes:

033-0561-01	N/A
-------------	-----



Dental Elevators
Potts

Material: Stainless steel

Other Sizes:

033-0567-01	N/A
033-0567-02	N/A



Dental Elevators
Potts, hollow handle

Material: Stainless steel

Other Sizes:

033-0569-01	N/A
033-0569-02	N/A

DENTAL ELEVATORS



Dental Elevators
Krallenheber, septum divider

Material: Stainless steel

Other Sizes:

033-0571-01	N/A
033-0571-02	N/A



Dental Elevators
1- straight 2- curved right

Material: Stainless steel

Other Sizes:

033-0572-01	15 cm
033-0572-02	15 cm



Dental Elevators
1-curved left 2-reverse curve

Material: Stainless steel

Other Sizes:

033-0572-03	17 cm
033-0572-04	15 cm



Dental Elevators
1-straight, small handle 2-curved right, small handle

Material: Stainless steel

Other Sizes:

033-0573-01	14 cm
033-0573-02	14 cm



Dental Elevators
Warwick-James

Material: Stainless steel

Other Sizes:

033-0576-01	N/A
-------------	-----



Dental Elevators
Warwick-James

Material: Stainless steel

Other Sizes:

033-0576-02	N/A
033-0576-03	N/A

DENTAL ELEVATORS



Dental Elevators
Chompret

Material: Stainless steel

Other Sizes:
033-0577-01 : N/A



Dental Elevators
Chompret #2

Material: Stainless steel

Other Sizes:
033-0577-02 : 16 cm



Dental Elevators
Chompret #3

Material: Stainless steel

Other Sizes:
033-0577-03 : 16 cm



Dental Elevators
Chompret #4

Material: Stainless steel

Other Sizes:
033-0577-04 : 16 cm



Dental Elevators
Howard-Apexo #1

Material: Stainless steel

Other Sizes:
033-0579-01 : N/A



Dental Elevators
Howard-Apexo

Material: Stainless steel

Other Sizes:
033-0579-02 : N/A
033-0579-03 : N/A

DENTAL ELEVATORS



Dental Elevators
Heidbrink #1

Material: Stainless steel

Other Sizes:
033-0582-01 : N/A



Dental Elevators
Heidbrink

Material: Stainless steel

Other Sizes:
033-0582-02 : N/A
033-0582-03 : N/A



Dental Elevators
Davis #1

Material: Stainless steel

Other Sizes:
033-0583-01 : 18 cm



Dental Elevators
Davis

Material: Stainless steel

Other Sizes:
033-0583-02 : 18 cm
033-0583-03 : 18 cm



Dental Elevators
West

Material: Stainless steel

Other Sizes:
033-0584-01 : 17 cm



Dental Elevators
West

Material: Stainless steel

Other Sizes:
033-0584-02 : 17 cm
033-0584-03 : 17 cm

DENTAL ELEVATORS

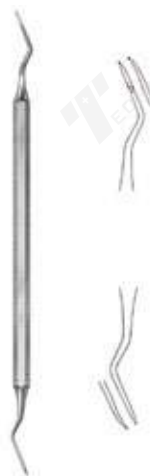

Dental Elevators
West

Material: Stainless steel

Other Sizes:

033-0588-03	16 cm
033-0588-06	16 cm



Dental Elevators
Davis

Material: Stainless steel

Other Sizes:

033-0589-10	21 cm
033-0589-11	21 cm



Dental Elevators
Walter F. Barry

Material: Stainless steel

Other Sizes:

033-0590-04	4 mm, 21.5 cm
033-0590-05	5 mm, 21.5 cm
033-0590-06	6 mm, 21.5 cm



Dental Elevators
root teaser

Material: Stainless steel

Other Sizes:

033-0591-01	19 cm
033-0591-02	19 cm



Dental Elevators
aspirating syringe, cylinder cartridge
syringe. with aspiration, with metric thread

Material: Stainless steel

Other Sizes:

033-0604-00	1.8 cc
-------------	--------



Dental Elevators
water syringe, with 1 cannula,
self-filling with rubber gasket

Material: Stainless steel

Other Sizes:

033-0652-00	10 cc
-------------	-------

DENTAL ELEVATORS



Dental Elevators
cannula only

Material: Stainless steel

Other Sizes:

033-0652-01 N/A



Dental Elevators
chip blower, complete, without
valve, bulb capacity 1 1/2 oz

Material: Stainless steel

Other Sizes:

033-0661-00 51.75 cc



Dental Elevators
cannula only

Material: Stainless steel

Other Sizes:

033-0661-01 N/A



Dental Elevators
Simple Thread, Plane metr. thread

Material: Stainless steel

Other Sizes:

033-0702-22 Ø 22 mm
033-0702-24 Ø 24 mm



Dental Elevators
Cone Socket, plane metr. thread

Material: Stainless steel

Other Sizes:

033-0706-20 Ø 20 mm
033-0706-22 Ø 22 mm
033-0706-24 Ø 24 mm



Dental Elevators
Hilger, cheek retractor with handle

Material: Stainless steel

Other Sizes:

033-0715-00 18 cm

DENTAL ELEVATORS



Dental Elevators

Hilger, cheek retractor, exchangeable attachment, suitable for any mouth, mirror handle

Material: Stainless steel

Other Sizes:

033-0715-01 : N/A



Dental Elevators

1- with simple thread 2- with cone socket

Material: Stainless steel

Other Sizes:

033-0721-01 : 14 cm
033-0721-02 : 14 cm



Dental Elevators

with simple thread

Material: Stainless steel

Other Sizes:

033-0726-01 : 12 cm
033-0728-01 : 12 cm



Dental Elevators

with cone socket

Material: Stainless steel

Other Sizes:

033-0726-02 : 12 cm



Dental Elevators

1-curved left, small handle
2-reverse curve, small handle

Material: Stainless steel

Other Sizes:

033-0773-03 : 14 cm
033-0773-04 : 14 cm



Dental Elevators

Heidbrink, root teaser, serrated

Material: Stainless steel

Other Sizes:

42-587-01 : 19 cm
42-587-02 : 19 cm
42-587-03 : 19 cm

DENTAL AND ORAL SURGERY

— RANGE

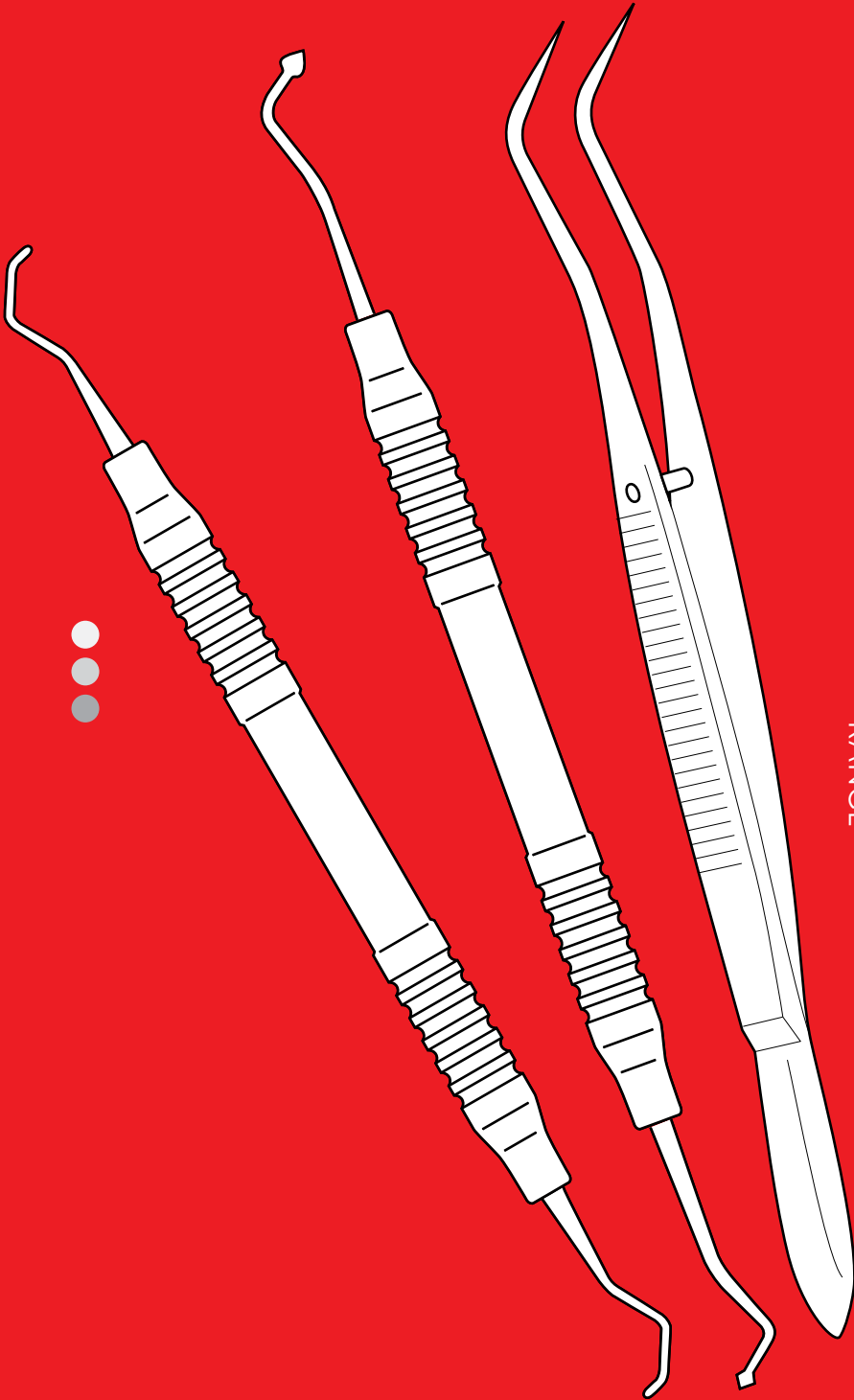

DISCOVER NOW

“Instruments for
surgical procedures”
Since 1970



Dental and Oral Surgery
London-College, cotton pliers, smooth

Material: Stainless steel

Other Sizes:
034-0031-04 15 cm



Dental and Oral Surgery
London-College, cotton pliers

Material: Stainless steel

Other Sizes:
034-0031-05 15 cm



Dental and Oral Surgery
London-College, cotton pliers, with lock

Material: Stainless steel

Other Sizes:
034-0037-05 15 cm



Dental and Oral Surgery
London-College, cotton pliers, for silver points

Material: Stainless steel

Other Sizes:
034-0037-08 N/A



Dental and Oral Surgery
Gilmore, heavy pattern probe

Material: Stainless steel

Other Sizes:
034-0100-99 N/A



Dental and Oral Surgery
Meriam

Material: Stainless steel

Other Sizes:
034-0101-01 16 cm
034-0101-03 16 cm
034-0101-04 16 cm

DENTAL AND ORAL SURGERY



Dental and Oral Surgery
Meriam, cotton pliers

Material: Stainless steel

Other Sizes:

034-0107-03	16 cm
034-0107-04	16 cm



Dental and Oral Surgery
Columbia, universal explorer

Material: Stainless steel

Other Sizes:

034-0290-14	16 cm
-------------	-------



Dental and Oral Surgery
explorer

Material: Stainless steel

Other Sizes:

034-0401-17	16 cm
-------------	-------



Dental and Oral Surgery
explorer

Material: Stainless steel

Other Sizes:

034-0401-23	5 cm
-------------	------



Dental and Oral Surgery
explorer, octagonal handle

Material: Stainless steel

Other Sizes:

034-0439-01	17 cm
-------------	-------



Dental and Oral Surgery
Mershon, band pusher

Material: Stainless steel

Other Sizes:

034-0528-01	N/A
-------------	-----

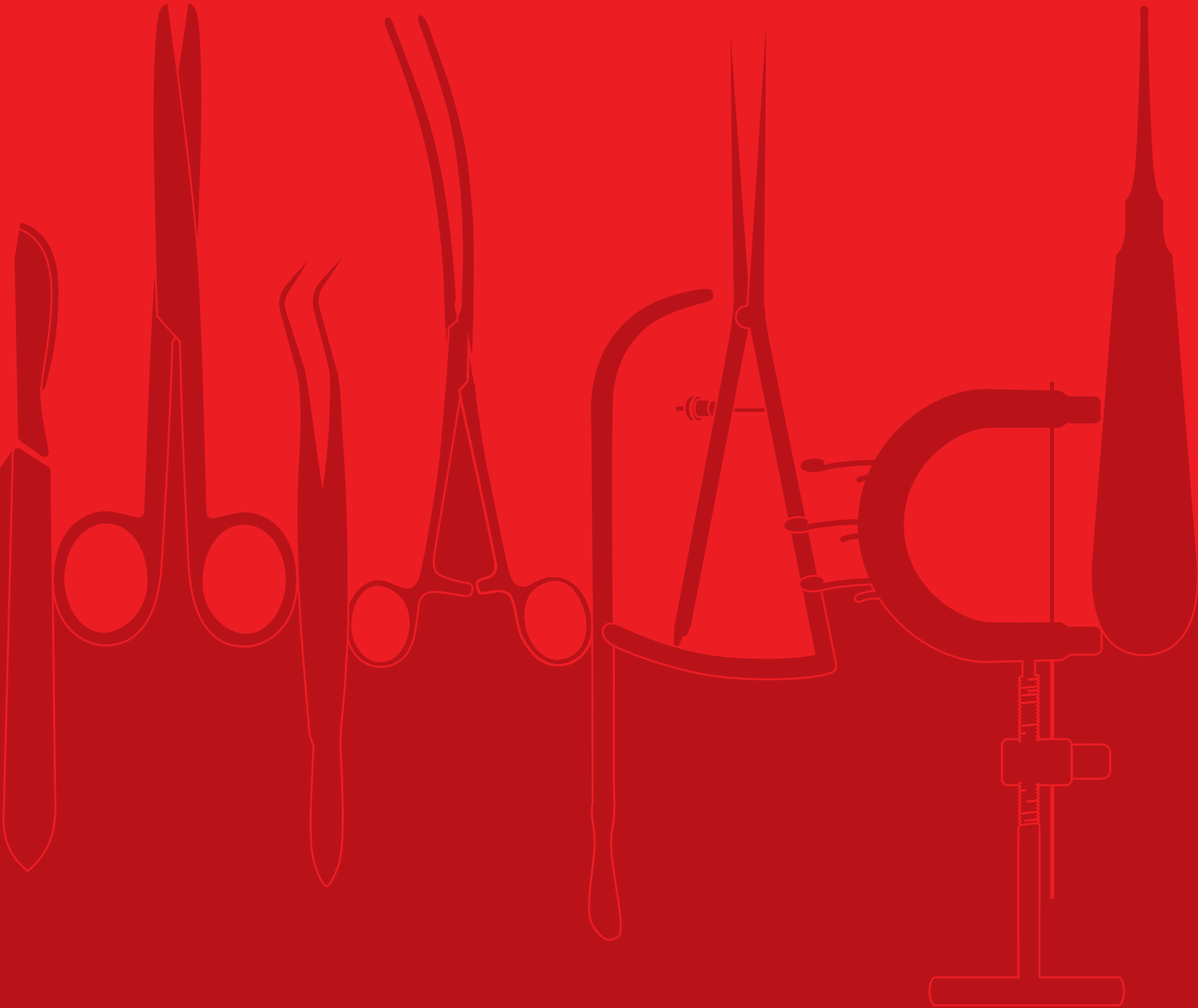

Manufacturer & Exporters of Quality
Surgical, Dental Instruments, Hospital
Equipments & Scissors of all sorts.

Tel: +44 191 670 9552

info@technimen.co.uk
www.technimen.co.uk

Technime Agha Limited UK



77 one three Sixty Jesmond
Newcastle upon Tyne
NE2 1DQ
United Kingdom

