

RETRACTORS

— RANGE



DISCOVER NOW



PEGASUSMED



OUR SERVICES



- Scissors
- Orthopedics
- Plastic Surgery
- Neuro Surgery
- General Surgery
- Gynecology, ENT
- Dental instruments,
- Cardiovascular instruments

OUR TEAM



Production Space
53,500 Ft²

COUNTRIES



Footprints In
More Than
16 Countries

OEM & ODM



Production Capabilities
State Of The Art
Vacuum Hardening
CNC Milling Facility

RETRACTORS



Retractors
Bone hooklet, acc. to Rasse, 1 prong

Material: Stainless steel

Other Sizes:
006-0006-10 : 16 cm



Retractors
Micro hooklet, acc. to Graefe, sharp

Material: Stainless steel

Other Sizes:
006-0066-01 : 15 cm



Retractors
Micro hooklet, acc. to Graefe, blunt

Material: Stainless steel

Other Sizes:
006-0066-02 : 15 cm



Retractors
Micro hook, sharp, 1 prong

Material: Stainless steel

Other Sizes:
006-0068-01 : 16 cm
006-0068-02 : 16 cm
006-0068-03 : 16 cm
006-0068-04 : 16 cm



Retractors
Micro hooklet, acc. to Rasse, sharp

Material: Stainless steel

Other Sizes:
006-0068-05 : 16 cm



Retractors
Hooklet, acc. to O'Connor, sharp, 1 prong

Material: Stainless steel

Other Sizes:
006-0070-16 : 16 cm

RETRACTORS



Retractors

Hooklet, acc. to Guthrie, sharp, 2 prongs

Material: Stainless steel

Other Sizes:

006-0072-01 : 15.5 cm
006-0072-02 : 15.5 cm



Retractors

Hooklet, sharp, 1 prong

Material: Stainless steel

Other Sizes:

006-0074-01 : 16.5 cm



Retractors

Hooklet, sharp, 2 prongs

Material: Stainless steel

Other Sizes:

006-0074-02 : 16.5 cm



Retractors

Hook-let, sharp, 3 prongs

Material: Stainless steel

Other Sizes:

006-0074-03 : 16.5 cm



Retractors

Hooklet, sharp, 4 prongs

Material: Stainless steel

Other Sizes:

006-0074-04 : 16.5 cm



Retractors

Hooklet, blunt, 1 prong

Material: Stainless steel

Other Sizes:

006-0075-01 : 16.5 cm

RETRACTORS



Retractors

Hooklet, blunt, 2 prongs

Material: Stainless steel

Other Sizes:

006-0075-02 : 16.5 cm



Retractors

Hooklet, blunt, 3 prongs

Material: Stainless steel

Other Sizes:

006-0075-03 : 16.5 cm



Retractors

Hooklet, blunt, 4 prongs

Material: Stainless steel

Other Sizes:

006-0075-04 : 16.5 cm



Retractors

Hooklet, flexible, sharp, 2 prongs

Material: Stainless steel

Other Sizes:

006-0078-02 : 16 cm



Retractors

Hooklet, flexible, sharp, 3 prongs

Material: Stainless steel

Other Sizes:

006-0078-03 : 16 cm



Retractors

Hooklet, flexible, blunt, 2 prongs

Material: Stainless steel

Other Sizes:

006-0079-02 : 16 cm

RETRACTORS



Retractors

Hooklet, flexible, blunt, 3 prongs

Material: Stainless steel

Other Sizes:

006-0079-03 : 16 cm



Retractors

Hooklet, delicate, sharp, 4 prongs

Material: Stainless steel

Other Sizes:

006-0086-04 : 16.5 cm



Retractors

Hooklet, delicate, blunt, 4 prongs

Material: Stainless steel

Other Sizes:

006-0087-04 : 16.5 cm



Retractors

Micro vascular hooklet, blunt

Material: Stainless steel

Other Sizes:

006-0088-12 : 12 cm



Retractors

Hooklet, acc. to Desmarres

Material: Stainless steel

Other Sizes:

006-0091-08 : 16 cm, 8mm
 006-0091-10 : 16 cm, 10mm
 006-0091-12 : 16 cm, 12mm
 006-0091-14 : 16 cm, 14mm
 006-0091-16 : 16 cm, 16mm
 006-0091-18 : 16 cm, 18mm



Retractors

Hooklet, fenestrated

Material: Stainless steel

Other Sizes:

006-0093-12 : 16 cm, 12mm
 006-0093-14 : 16 cm, 14mm
 006-0093-16 : 16 cm, 16mm
 006-0093-18 : 16 cm, 18mm

RETRACTORS



Retractors

Hooklet, acc. to Mini-Langenbeck, 16 cm

Material: Stainless steel

Other Sizes:

- 006-0095-10 : 10 x 6 mm
- 006-0095-17 : 17 x 5mm
- 006-0095-20 : 20 x 6 mm
- 006-0095-22 : 22 x 8 mm



Retractors

Retractor, blunt, 2 prongs,

Material: Stainless steel

Other Sizes:

- 006-0099-16 : 14 x 8 mm, 16 cm



Retractors

Retractor, delicated, sharp, 1 prong

Material: Stainless steel

Other Sizes:

- 006-0100-01 : 16.5 cm



Retractors

Retractor, delicated, sharp, 2 prongs

Material: Stainless steel

Other Sizes:

- 006-0100-02 : 16.5 cm



Retractors

Retractor, delicated, sharp, 3 prongs

Material: Stainless steel

Other Sizes:

- 006-0100-03 : 16.5 cm



Retractors

Retractor, delicated, sharp, 4 prongs

Material: Stainless steel

Other Sizes:

- 006-0100-04 : 16.5 cm

RETRACTORS



Retractors
Retractor, delicate, blunt, 1 prong

Material: Stainless steel

Other Sizes:
006-0101-01 : 16.5 cm



Retractors
Retractor, delicate, blunt, 2 prongs

Material: Stainless steel

Other Sizes:
006-0101-02 : 16.5 cm



Retractors
Retractor, delicate, blunt, 3 prongs

Material: Stainless steel

Other Sizes:
006-0101-03 : 16.5 cm



Retractors
Retractor, delicate, blunt, 4 prongs

Material: Stainless steel

Other Sizes:
006-0101-04 : 16.5 cm



Retractors
Hooklet, acc. to Meyerding

Material: Stainless steel

Other Sizes:
006-0151-01 : 18 x 7 mm, 17.5 cm



Retractors
Hooklet, acc. to Meyerding

Material: octagonal handle

Other Sizes:
006-0151-02 : 16 x 5 mm, 17.5 cm

RETRACTORS



Retractors

Hooklet, acc. to Meyerding

Material: Stainless steel

Other Sizes:

006-0151-03 : 7 x 4 mm, 17.5 cm

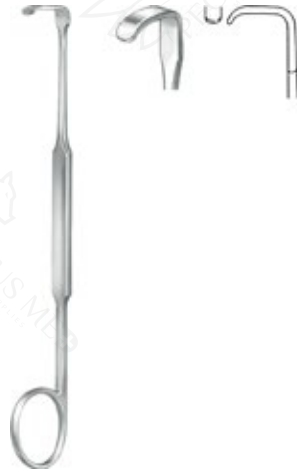

Retractors

Hooklet, acc. to Meyerding

Material: Stainless steel

Other Sizes:

006-0151-04 : 12 x 4 mm, 17.5 cm



Retractors

Hooklet, acc. to Meyerding

Material: Stainless steel

Other Sizes:

006-0151-05 : 8 x 4 mm, 17.5 cm



Retractors

Hooklet, acc. to Meyerding

Material: Stainless steel

Other Sizes:

006-0151-06 : 7 x 9 mm, 17.5 cm



Retractors

Hooklet, acc. to Senn-Green

Material: Stainless steel

Other Sizes:

006-0161-01 : 20 x 6 mm, 15 cm



Retractors

Hooklet, acc. to Senn-Green

Material: Stainless steel

Other Sizes:

006-0161-02 : 10 x 6 mm, 15 cm

RETRACTORS



Retractors
Hooklet, acc. to Ragnell-Davies, double

Material: Stainless steel

Other Sizes:
006-0164-14 : 15 cm

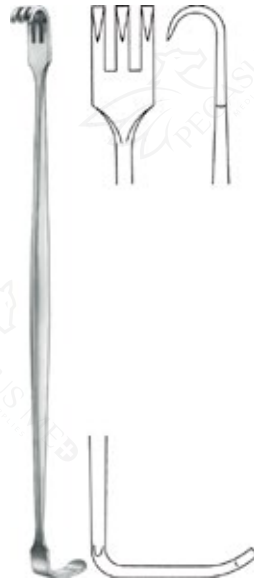

Retractors
Hooklet, acc. to Senn-Mueller, sharp

Material: Stainless steel

Other Sizes:
006-0166-16 : 16 cm



Retractors
Hooklet, acc. to Senn-Mueller, blunt

Material: Stainless steel

Other Sizes:
006-0167-16 : 16 cm



Retractors
Retractor, acc. to Cushing fenestrated

Material: Stainless steel

Other Sizes:
006-0170-20 : 20.5 cm



Retractors
Hooklet, acc. to Cushing

Material: Stainless steel

Other Sizes:
006-0171-08 : 8 mm, 20.5 cm
006-0171-10 : 10 mm, 20.5 cm
006-0171-12 : 12 mm, 20.5 cm
006-0171-14 : 14 mm, 20.5 cm
006-0171-16 : 16 mm, 20.5 cm
006-0171-18 : 18 mm, 20.5 cm



Retractors
Hooklet, acc. to Cushing

Material: Stainless steel

Other Sizes:
006-0172-08 : 8 mm, 24 cm
006-0172-10 : 10 mm, 24 cm
006-0172-12 : 12 mm, 24 cm
006-0172-14 : 14 mm, 24 cm
006-0172-16 : 16 mm, 24 cm
006-0172-18 : 18 mm, 24 cm

RETRACTORS



Retractors
Hooklet, malleable shaft

Material: Stainless steel

Other Sizes:

006-0174-08	8 mm, 24 cm
006-0174-11	11 mm, 24 cm
006-0174-15	15 mm, 24 cm
006-0174-17	17 mm, 24 cm
006-0174-20	20 mm, 24 cm
006-0174-23	23 mm, 24 cm
006-0174-04	4 mm, 24 cm
006-0174-06	6 mm, 24 cm



Retractors
Vein hooklet, acc. to Brom, small

Material: Stainless steel

Other Sizes:

006-0176-01	19.5 cm
-------------	---------



Retractors
Vein hooklet, acc. to Brom, large

Material: Stainless steel

Other Sizes:

006-0176-02	19.5 cm
-------------	---------



Retractors
Hooklet, acc. to Strandell-Stille, no. 1

Material: Stainless steel

Other Sizes:

006-0191-01	19 cm
-------------	-------



Retractors
Hooklet, acc. to Strandell-Stille, no. 2

Material: Stainless steel

Other Sizes:

006-0191-02	19 cm
-------------	-------



Retractors
Hooklet, acc. to Kaye-Millard,
2 prongs, sharp

Material: Stainless steel

Other Sizes:

006-0192-02	8 cm
-------------	------

RETRACTORS



Retractors
Retractor, acc. to Klapp, 2 prongs, blunt

Material: Stainless steel

Other Sizes:
006-0195-01 : 12 x 6 mm, 17.5 cm



Retractors
Retractor, acc. to Klapp, 3 prongs, blunt

Material: Stainless steel

Other Sizes:
006-0195-02 : 12 x 11 mm, 17.5 cm



Retractors
Retractor, acc. to Klapp, 4 prongs, blunt

Material: Stainless steel

Other Sizes:
006-0195-03 : 15x11 mm, 17.5 cm



Retractors
Hooklet, delicate, 4 prongs, sharp

Material: Stainless steel

Other Sizes:
006-0200-04 : 16.5 cm



Retractors
Hooklet, delicate, 4 prongs, blunt

Material: Stainless steel

Other Sizes:
006-0201-04 : 16.5 cm



Retractors
Retractor, acc. to Volkmann, sharp, 1 prong

Material: Stainless steel

Other Sizes:
006-0210-01 : 21.5 cm

RETRACTORS



Retractors

Retractor, acc. to Volkmann, sharp, 2 prongs

Material: Stainless steel

Other Sizes:

006-0210-02 : 21.5 cm



Retractors

Retractor, acc. to Volkmann, sharp, 3 prongs

Material: Stainless steel

Other Sizes:

006-0210-03 : 21.5 cm



Retractors

Retractor, acc. to Volkmann, sharp, 4 prongs

Material: Stainless steel

Other Sizes:

006-0210-04 : 21.5 cm



Retractors

Retractor, acc. to Volkmann, sharp, 6 prongs

Material: Stainless steel

Other Sizes:

006-0210-06 : 21.5 cm



Retractors

Retractor, acc. to Volkmann, blunt, 1 prong

Material: Stainless steel

Other Sizes:

006-0211-01 : 21.5 cm



Retractors

Retractor, acc. to Volkmann, blunt, 2 prongs

Material: Stainless steel

Other Sizes:

006-0211-02 : 21.5 cm

RETRACTORS



Retractors

Retractor, acc. to Volkmann, blunt, 3 prongs

Material: Stainless steel

Other Sizes:

006-0211-03 21.5 cm



Retractors

Retractor, acc. to Volkmann, blunt, 4 prongs

Material: Stainless steel

Other Sizes:

006-0211-04 21.5 cm



Retractors

Retractor, acc. to Volkmann, blunt, 6 prongs

Material: Stainless steel

Other Sizes:

006-0211-06 21.5 cm



Retractors

Retractor, acc. to Volkmann, sharp, 1 prong

Material: Stainless steel

Other Sizes:

006-0220-01 22 cm



Retractors

Retractor, acc. to Volkmann, sharp, 2 prongs

Material: Stainless steel

Other Sizes:

006-0220-02 22 cm



Retractors

Retractor, acc. to Volkmann, sharp, 3 prongs

Material: Stainless steel

Other Sizes:

006-0220-03 22 cm

RETRACTORS



Retractors

Retractor, acc. to Volkmann, sharp, 6 prongs

Material: Stainless steel

Other Sizes:

006-0220-06 : 22 cm



Retractors

Retractor, acc. to Volkmann, sharp, 4 prongs

Material: Stainless steel

Other Sizes:

006-220-04 : 22 cm

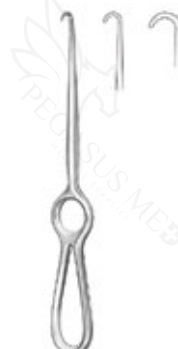

Retractors

Retractor, acc. to Volkmann, blunt, 1 prong

Material: Stainless steel

Other Sizes:

006-0221-01 : 22 cm



Retractors

Retractor, acc. to Volkmann, blunt, 2 prongs

Material: Stainless steel

Other Sizes:

006-0221-02 : 22 cm



Retractors

Retractor, acc. to Volkmann, blunt, 3 prongs

Material: Stainless steel

Other Sizes:

006-0221-03 : 22 cm



Retractors

Retractor, acc. to Volkmann, blunt, 4 prongs

Material: Stainless steel

Other Sizes:

006-0221-04 : 22 cm

RETRACTORS



Retractors

Retractor, acc. to Volkmann, blunt, 6 prongs

Material: Stainless steel

Other Sizes:

006-0221-06 : 22 cm



Retractors

Retractor, acc. to Volkmann, semi-sharp, 1 prong

Material: Stainless steel

Other Sizes:

006-0222-01 : 22 cm

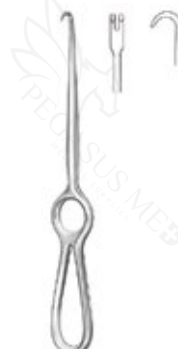

Retractors

Retractor, acc. to Volkmann, semi-sharp, 2 prongs

Material: Stainless steel

Other Sizes:

006-0222-02 : 22 cm



Retractors

Retractor, acc. to Volkmann, semi-sharp, 3 prongs

Material: Stainless steel

Other Sizes:

006-0222-03 : 22 cm



Retractors

Retractor, acc. to Volkmann, semi-sharp, 4 prongs

Material: Stainless steel

Other Sizes:

006-0222-04 : 22 cm



Retractors

Retractor, acc. to Volkmann, semi-sharp, 6 prongs

Material: Stainless steel

Other Sizes:

006-0222-06 : 22 cm

RETRACTORS



Retractors

Retractor, acc. to Volkmann, sharp, 1 prong

Material: Stainless steel

Other Sizes:

006-0230-01 21.5 cm



Retractors

Retractor, acc. to Volkmann, blunt, 1 prong

Material: Stainless steel

Other Sizes:

006-0231-01 21.5 cm

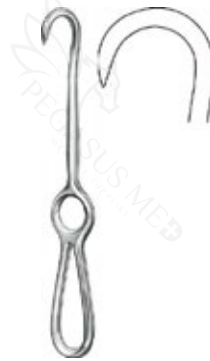

Retractors

Retractor, 1 prong, sharp

Material: Stainless steel

Other Sizes:

006-0232-01 21.5 cm



Retractors

Retractor, acc. to KoCher, sharp, 1 prong

Material: Stainless steel

Other Sizes:

006-0240-01 22 cm



Retractors

Retractor, acc. to KoCher, sharp, 2 prongs

Material: Stainless steel

Other Sizes:

006-0240-02 22 cm



Retractors

Retractor, acc. to KoCher, sharp, 3 prongs

Material: Stainless steel

Other Sizes:

006-0240-03 22 cm

RETRACTORS



Retractors
Retractor, acc. to KoCher, sharp, 4 prongs

Material: Stainless steel

Other Sizes:
006-0240-04 22 cm

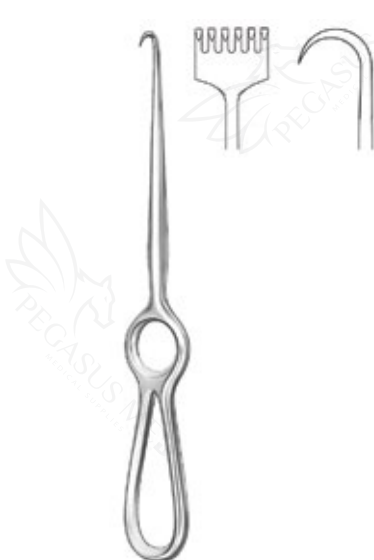

Retractors
Retractor, acc. to KoCher, sharp, 6 prongs

Material: Stainless steel

Other Sizes:
006-0240-06 22 cm

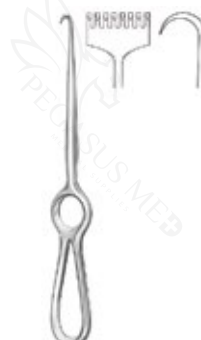

Retractors
Retractor, acc. to KoCher, sharp, 8 prongs

Material: Stainless steel

Other Sizes:
006-0240-08 22 cm



Retractors
Retractor, acc. to KoCher, blunt, 1 prong

Material: Stainless steel

Other Sizes:
006-0241-01 22 cm



Retractors
Retractor, acc. to KoCher, blunt, 2 prongs

Material: Stainless steel

Other Sizes:
006-0241-02 22 cm



Retractors
Retractor, acc. to KoCher, blunt, 3 prongs

Material: Stainless steel

Other Sizes:
006-0241-03 22 cm

RETRACTORS



Retractors

Retractor, acc. to KoCher, blunt, 4 prongs

Material: Stainless steel

Other Sizes:

006-0241-04 : 22 cm

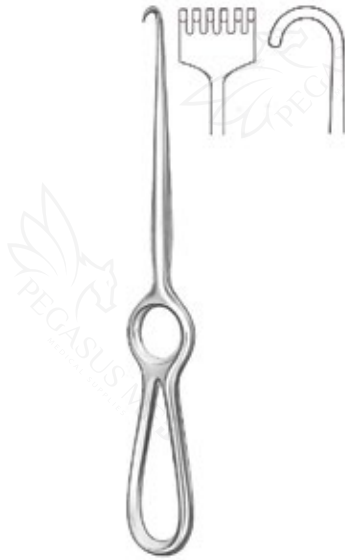

Retractors

Retractor, acc. to KoCher, blunt, 6 prongs

Material: Stainless steel

Other Sizes:

006-0241-06 : 22 cm

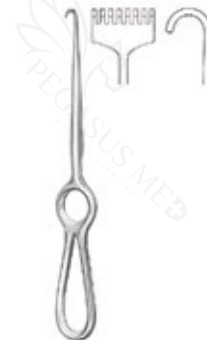

Retractors

Retractor, acc. to KoCher, blunt, 8 prongs

Material: Stainless steel

Other Sizes:

006-0241-08 : 22 cm



Retractors

Retractor, acc. to KoCher, semi-sharp, 1 prong

Material: Stainless steel

Other Sizes:

006-0242-01 : 22 cm



Retractors

Retractor, acc. to KoCher, semi-sharp, 2 prongs

Material: Stainless steel

Other Sizes:

006-0242-02 : 22 cm



Retractors

Retractor, acc. to KoCher, semi-sharp, 3 prongs

Material: Stainless steel

Other Sizes:

006-0242-03 : 22 cm

RETRACTORS



Retractors

Retractor, acc. to KoCher, semi-sharp
4 prongs

Material: Stainless steel

Other Sizes:

006-0242-04 : 22 cm



Retractors

Retractor, acc. to KoCher, semi-sharp,
6 prongs

Material: Stainless steel

Other Sizes:

006-0242-06 : 22 cm

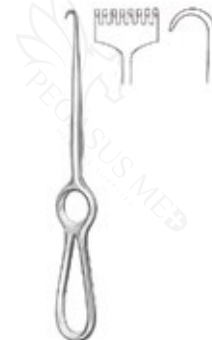

Retractors

Retractor, acc. to KoCher, semi-sharp,
8 prongs

Material: Stainless steel

Other Sizes:

006-0242-08 : 22 cm

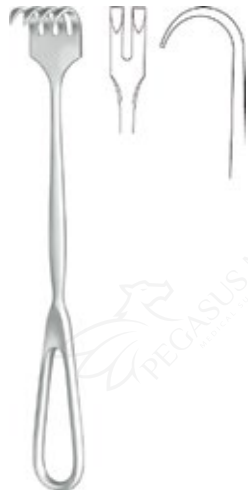

Retractors

Retractor, acc. to acc. to Martin, sharp,
2 prongs

Material: Stainless steel

Other Sizes:

006-0245-02 : 22.5 cm

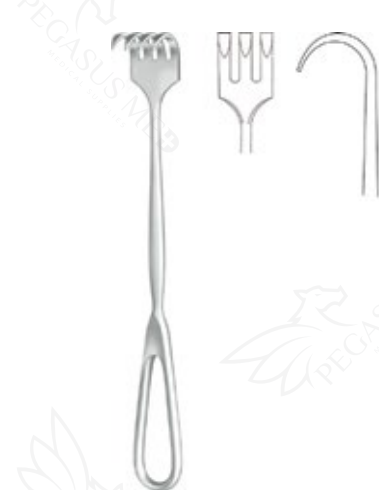

Retractors

Retractor, acc. to acc. to Martin, sharp,
3 prongs

Material: Stainless steel

Other Sizes:

006-0245-03 : 22.5 cm



Retractors

Retractor, acc. to acc. to Martin, sharp,
4 prongs

Material: Stainless steel

Other Sizes:

006-0245-04 : 22.5 cm

RETRACTORS

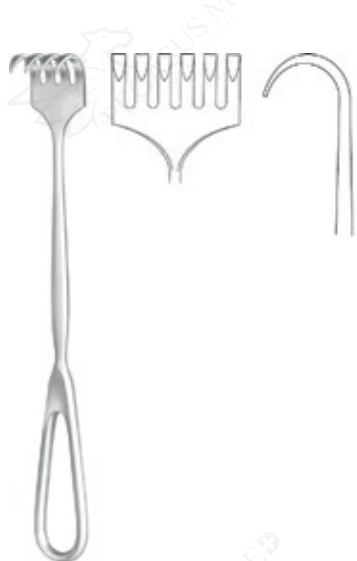

Retractors

Retractor, acc. to acc. to Martin, sharp, 6 prongs

Material: Stainless steel

Other Sizes:

006-0245-06 : 22.5 cm

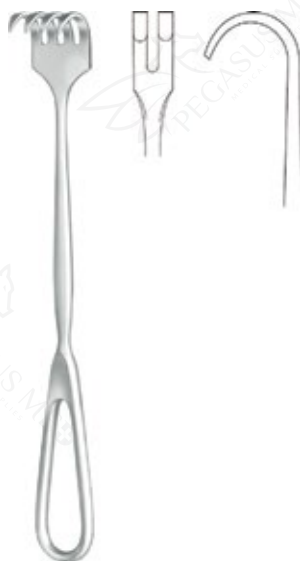

Retractors

Retractor, acc. to acc. to Martin, blunt, 2 prongs

Material: Stainless steel

Other Sizes:

006-0246-02 : 22.5 cm



Retractors

Retractor, acc. to acc. to Martin, blunt, 3 prongs

Material: Stainless steel

Other Sizes:

006-0246-03 : 22.5 cm

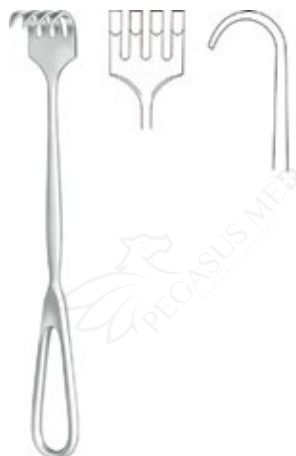

Retractors

Retractor, acc. to acc. to Martin, blunt, 4 prongs

Material: Stainless steel

Other Sizes:

006-0246-04 : 22.5 cm



Retractors

Retractor, acc. to acc. to Martin, blunt, 6 prongs

Material: Stainless steel

Other Sizes:

006-0246-06 : 22.5 cm



Retractors

Retractor, acc. to Ollier, blunt, 37 x 30 mm

Material: Stainless steel

Other Sizes:

006-0251-03 : 23 cm

RETRACTORS



Retractors
Retractor, acc. to Ollier, blunt, 39 x 60 mm

Material: Stainless steel

Other Sizes:
006-0253-04 : 23 cm



Retractors
Retractor, acc. to Wassmund, 33 x 21 mm

Material: Stainless steel

Other Sizes:
006-0261-02 : 20.5 cm



Retractors
Retractor, acc. to Koerte, sharp, 8 prongs, 40 x 30 mm

Material: Stainless steel

Other Sizes:
006-0266-08 : 24.5 cm



Retractors
Retractor, acc. to Koerte, blunt, 8 prongs, 40 x 30 mm

Material: Stainless steel

Other Sizes:
006-0267-08 : 24.5 cm



Retractors
Retractor, acc. to Israel, blunt

Material: Stainless steel

Other Sizes:
006-0281-04 : 40 x 40 mm, 25.5 cm



Retractors
Retractor, acc. to Israel, blunt

Material: Stainless steel

Other Sizes:
006-0283-05 : 45 x 50 mm, 25.5 cm

RETRACTORS



Retractors

Retractor, acc. to Israel, blunt

Material: Stainless steel

Other Sizes:

006-0287-06 : 50 x 60 mm, 25.5 cm



Retractors

Retractor, acc. to Israel, blunt

Material: Stainless steel

Other Sizes:

006-0289-07 : 70 x 70 mm, 25.5 cm



Retractors

Retractor, acc. to Langenbeck

Material: Stainless steel

Other Sizes:

006-0291-01 : 30 x 11 mm, 22.5 cm
 006-0291-02 : 30 x 14 mm, 22.5 cm
 006-0291-03 : 30 x 16 mm, 22.5 cm
 006-0291-04 : 40 x 11 mm, 22.5 cm
 006-0291-05 : 50 x 11 mm, 22.5 cm



Retractors

Retractor, acc. to Langenbeck

Material: Stainless steel

Other Sizes:

006-0293-01 : 30 x 11 mm, 22.5 cm
 006-0293-02 : 30 x 14 mm, 22.5 cm
 006-0293-03 : 30 x 16 mm, 22.5 cm
 006-0293-04 : 40 x 11 mm, 22.5 cm
 006-0293-05 : 50 x 11 mm, 22.5 cm



Retractors

Retractor, acc. to Langenbeck

Material: Stainless steel

Other Sizes:

006-0295-21 : 65 x 20 mm, 21 cm



Retractors

Retractor, acc. to Langenbeck

Material: Stainless steel

Other Sizes:

006-0297-21 : 85 x 15 mm, 22.5 cm

RETRACTORS



Retractors

Retractor, acc. to Langenbeck, 43 x 13 mm

Material: Stainless steel

Other Sizes:

006-0299-01 : 21 cm



Retractors

Retractor, acc. to Langenbeck-Green

Material: Stainless steel

Other Sizes:

006-0301-16 : 6 x 16 mm, 16 cm
006-0301-25 : 6 x 25 mm, 16 cm



Retractors

Retractor, acc. to Lahey

Material: Stainless steel

Other Sizes:

006-0307-19 : 31 x 6 mm, 19.5 cm



Retractors

Retractor, acc. to Little

Material: Stainless steel

Other Sizes:

006-0313-20 : 13 x 15 mm, 20 cm



Retractors

Retractor, acc. to KoCher

Material: Stainless steel

Other Sizes:

006-0315-18 : 43 x 18 mm, 23 cm
006-0315-20 : 53 x 20 mm, 23 cm
006-0315-25 : 63 x 25 mm, 23 cm
006-0315-30 : 77 x 30 mm, 23 cm
006-0315-40 : 78 x 40 mm, 23 cm



Retractors

Retractor, acc. to KoCher-Langenbeck

Material: Stainless steel

Other Sizes:

006-0317-01 : 25 x 6 mm, 21.5 cm
006-0317-02 : 35 x 8 mm, 21.5 cm
006-0317-03 : 35 x 11 mm, 21.5 cm
006-0317-04 : 35 x 15 mm, 21.5 cm
006-0317-05 : 40 x 11 mm, 21.5 cm
006-0317-06 : 55 x 11 mm, 21.5 cm
006-0317-07 : 70 x 14 mm, 21.5 cm
006-0317-08 : 80 x 12 mm, 21.5 cm
006-0317-09 : 80 x 16 mm, 21.5 cm

RETRACTORS



Retractors

Retractor, acc. to KoCher-Langenbeck

Material: Stainless steel

Other Sizes:

006-0319-01	25 x 10 mm, 21.5 cm
006-0319-02	40 x 13 mm, 21.5 cm
006-0319-03	60 x 13 mm, 21.5 cm
006-0319-04	40 x 18 mm, 21.5 cm
006-0319-05	60 x 18 mm, 21.5 cm
006-0319-06	85 x 18 mm, 21.5 cm
006-0319-07	60 x 25 mm, 21.5 cm
006-0319-08	85 x 25 mm, 21.5 cm



Retractors

Retractor, acc. to Zenker, angled

Material: Stainless steel

Other Sizes:

006-0321-01	35 x 8 mm, 30.5 cm
006-0321-03	75 x 12 mm, 30.5 cm
006-0321-04	85 x 20 mm, 30.5 cm
006-0321-05	100 x 25 mm, 30.5 cm
006-0321-02	60 x 12 mm, 30.5 cm



Retractors

Retractor, acc. to KoCher

Material: Stainless steel

Other Sizes:

006-0325-01	22 x 12 mm, 21.5 cm
006-0325-02	24 x 14 mm, 21.5 cm

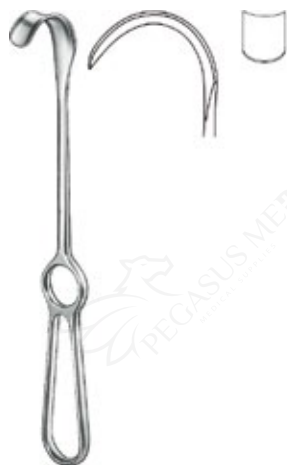

Retractors

Retractor, acc. to KoCher

Material: Stainless steel

Other Sizes:

006-0351-01	42 x 10 mm, 22 cm
006-0351-02	42 x 15 mm, 23 cm
006-0351-03	43 x 20 mm, 23 cm

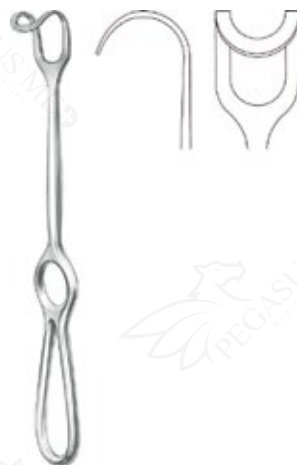

Retractors

Retractor, acc. to Middeldorpf

Material: Stainless steel

Other Sizes:

006-0361-01	18 x 17 mm, 21.5 cm
006-0361-02	25 x 22 mm, 23 cm
006-0361-03	18 x 17 mm, 24.5 cm



Retractors

Retractor, acc. to Richardson-Eastman, no. 1

Material: steel 18/8 martinit, antimagnetic, stainless, acid-resistant

Other Sizes:

006-0381-01	26 cm
-------------	-------

RETRACTORS



Retractors

Retractor, acc. to RiChardson-Eastman, no. 2

Material: steel 18/8 martinit, antimagnetic, stainless, acid-resistant

Other Sizes:
006-0381-02 : 27 cm



Retractors

Retractor, acc. to RiChardson

Material: steel 18/8 martinit, antimagnetic, stainless, acid-resistant

Other Sizes:
006-0391-01 : 25 x 21 mm, 23.5 cm
006-0391-02 : 37 x 29 mm, 24 cm
006-0391-03 : 45 x 40 mm, 24 cm



Retractors

Retractor, acc. to RiChardson

Material: steel 18/8 martinit, antimagnetic, stainless, acid-resistant

Other Sizes:
006-0395-24 : 53 x 22 mm, 24 cm



Retractors

Retractor, acc. to Kelly

Material: steel 18/8 martinit, antimagnetic, stainless, acid-resistant

Other Sizes:
006-0397-26 : 70 x 50 mm, 26 cm



Retractors

Retractor, acc. to acc. to Doyen-Stille

Material: Stainless steel

Other Sizes:
006-0401-01 : 97 x 29 mm, 26 cm
006-0401-02 : 101 x 31 mm, 26 cm
006-0401-03 : 127 x 52 mm, 26 cm



Retractors

Retractor, acc. to Hoesel

Material: Stainless steel

Other Sizes:
006-0405-01 : 63 x 21 mm, 26 cm
006-0405-02 : 83 x 30 mm, 26 cm
006-0405-03 : 103 x 30 mm, 26 cm
006-0405-04 : 120 x 30 mm, 26 cm
006-0405-05 : 140 x 30 mm, 26 cm
006-0405-06 : 140 x 40 mm, 26 cm

RETRACTORS



Retractors

Retractor, acc. to Middeldorpf

Material: Stainless steel

Other Sizes:

006-0441-01 : 48 x 45 mm, 27 cm

Retractors

Retractor, acc. to Middeldorpf

Material: Stainless steel

Other Sizes:

006-0441-02 : 52 x 50 mm, 27 cm
006-0441-03 : 60 x 70 mm, 70 cm

Retractors

Retractor, acc. to Fritsch

Material: Stainless steel

Other Sizes:

006-0452-00 : 37 x 31 mm, 23.5 cm
006-0452-01 : 38 x 40 mm, 24 cm
006-0452-02 : 43 x 51 mm, 25 cm
006-0452-03 : 49 x 61 mm, 25 cm
006-0452-04 : 48 x 75 mm, 25.5 cm
006-0452-05 : 65 x 85 mm, 26.5 cm



Retractors

Retractor, abdominal, acc. to acc. to Doyen

Material: steel 18/8 martinit, antimagnetic, stainless, acid-resistant

Other Sizes:

006-0461-25 : 48 x 88 mm, 24 cm



Retractors

Retractor, acc. to KoCher

Material: Stainless steel

Other Sizes:

006-0469-22 : 73 x 25 mm, 24 cm



Retractors

Retractor, acc. to KoCher

Material: Stainless steel

Other Sizes:

006-0471-01 : 80 x 45 mm, 25 cm
006-0471-02 : 80 x 55 mm, 25 cm
006-0471-03 : 80 x 65 mm, 25 cm

RETRACTORS



Retractors

Retractor, acc. to Martin

Material: Stainless steel

Other Sizes:

006-0501-25 : 110 x 27 mm, 26 cm



Retractors

Retractor, acc. to acc. to Simon

Material: Stainless steel

Other Sizes:

006-0505-28 : 115 x 22 mm, 28 cm
006-0507-28 : 115 x 27 mm, 28 cm



Retractors

Retractor, acc. to Coryllos

Material: Stainless steel

Other Sizes:

006-0537-01 : 85 x 22 mm, 24 cm
006-0537-02 : 108 x 43 mm, 24 cm
006-0537-03 : 119 x 65 mm, 24 cm



Retractors

Scapula retractor

Material: Stainless steel

Other Sizes:

006-0545-01 : 80 x 54 mm, 19 cm



Retractors

Scapula retractor

Material: Stainless steel

Other Sizes:

006-0545-02 : 80 x 95 mm, 18.5 cm



Retractors

Retractor, acc. to SauerbruCh

Material: Stainless steel

Other Sizes:

006-0551-25 : 127 x 38 mm, 25.5 cm

RETRACTORS



Retractors

Retractor, acc. to acc. to Brunner, straight

Material: Stainless steel

Other Sizes:

006-0558-08	84 x 20 mm, 25.5 cm
006-0558-10	104 x 25 mm, 25.5 cm
006-0558-12	124 x 30 mm, 25.5 cm
006-0558-13	130 x 30 mm, 25.5 cm
006-0558-14	144 x 30 mm, 25.5 cm
006-0558-16	160 x 30 mm, 25.5 cm
006-0558-18	164 x 30 mm, 25.5 cm



Retractors

Retractor, acc. to acc. to Brunner, curved

Material: Stainless steel

Other Sizes:

006-0559-08	82 x 20 mm, 25.5 cm
006-0559-10	102 x 20 mm, 25.5 cm
006-0559-12	122 x 25 mm, 25.5 cm
006-0559-14	140 x 25 mm, 25.5 cm
006-0559-16	162 x 30 mm, 25.5 cm
006-0559-18	182 x 30 mm, 25.5 cm



Retractors

Retractor, acc. to SauerbruCh

Material: Stainless steel

Other Sizes:

006-0561-01	50 x 15 mm, 22.5 cm
006-0561-02	63 x 23 mm, 22.5 cm
006-0561-03	80 x 20 mm, 22.5 cm



Retractors

N/A

Material: Stainless steel

Other Sizes:

006-0562-01	19 cm, 15x15 mm
006-0562-02	19 cm, 15x23 mm



Retractors

aorta retractor, acc. to Ross, flexible shaft, no. 1

Material: Stainless steel

Other Sizes:

006-0563-01	25.5 cm
-------------	---------



Retractors

aorta retractor, acc. to Ross, flexible shaft, no. 2

Material: Stainless steel

Other Sizes:

006-0563-02	25.5 cm
-------------	---------

RETRACTORS



Retractors
aorta retractor, acc.to Ross, flexible shaft,
no. 3

Material: Stainless steel

Other Sizes:
006-0563-03 : 25.5 cm



Retractors
aorta retractor, acc.to Ross, flexible shaft,
no. 4

Material: Stainless steel

Other Sizes:
006-0563-04 : 25.5 cm



Retractors
aorta retractor, acc.to Ross, flexible shaft,
no. 5

Material: Stainless steel

Other Sizes:
006-0563-05 : 25.5 cm



Retractors
aorta retractor, acc.to Ross, flexible shaft,
no. 6

Material: Stainless steel

Other Sizes:
006-0563-06 : 25.5 cm



Retractors
aorta valve Retractor, acc.to Borowski

Material: Stainless steel

Other Sizes:
006-0564-03 : 20 x 25 mm, 27 cm
006-0564-04 : 24 x 27 mm, 27 cm
006-0564-05 : 28 x 20 mm, 27 cm
006-0564-06 : 28 x 29 mm, 27 cm



Retractors
Retractor, acc. to Polloson, tip 60 mm

Material: Stainless steel

Other Sizes:
006-0577-27 : 29 cm

RETRACTORS



Retractors

Retractor, acc. to Polloson, fenestrated

Material: Stainless steel

Other Sizes:

006-0579-27 : 25.5 cm

Retractors

Retractor, acc. to Harrington

Material: Stainless steel

Other Sizes:

006-0581-01 : 137 x 44 mm, 31.5 cm
006-0581-02 : 137 x 65 mm, 33 cm

Retractors

Retractor, acc. to Deaver, 19 mm wide

Material: Stainless steel

Other Sizes:

006-0591-00 : 18 cm
006-0591-01 : 18 cm



Retractors

Retractor, acc. to Deaver, 22 mm wide

Material: Stainless steel

Other Sizes:

006-0591-02 : 21.5 cm

Retractors

Retractor, acc. to Deaver, 25 mm wide

Material: Stainless steel

Other Sizes:

006-0591-03 : 25 cm

Retractors

Retractor, acc. to Deaver, 25 mm wide

Material: Stainless steel

Other Sizes:

006-0591-04 : 31 cm

RETRACTORS



Retractors

Retractor, acc. to Deaver, 25 mm wide

Material: Stainless steel

Other Sizes:

006-0591-05 : 33 cm



Retractors

Retractor, acc. to Deaver, 25 mm wide

Material: Stainless steel

Other Sizes:

006-0591-06 : 36 cm



Retractors

Retractor, acc. to Deaver, 38 mm wide

Material: Stainless steel

Other Sizes:

006-0591-07 : 30 cm



Retractors

Retractor, acc. to Deaver, 50 mm wide

Material: Stainless steel

Other Sizes:

006-0591-08 : 31 cm



Retractors

Retractor, acc. to Deaver, 75 mm wide

Material: Stainless steel

Other Sizes:

006-0591-09 : 31.5 cm



Retractors

Retractor, acc. to Deaver-Grip

Material: Stainless steel

Other Sizes:

006-0592-04 : 25 mm, 31.5 cm
 006-0592-07 : 38 mm, 31.5 cm
 006-0592-08 : 50 mm, 31.5 cm
 006-0592-10 : 100 mm, 31.5 cm

RETRACTORS



Retractors
Atrium Retractor, right

Material: steel 18/8 martinit, antimagnetic, stainless, acid-resistant

Other Sizes:
006-0593-01 : 48 x 48 mm, 25 cm



Retractors
Atrium Retractor, serrated

Material: steel 18/8 martinit, antimagnetic, stainless, acid-resistant

Other Sizes:
006-0593-02 : 48 x 48 mm, 25 cm



Retractors
Atrium Retractor, left

Material: steel 18/8 martinit, antimagnetic, stainless, acid-resistant

Other Sizes:
006-0593-03 : 30 x 48 mm, 27 cm



Retractors
Retractor, acc. to Milkulicz

Material: Stainless steel

Other Sizes:
006-0603-01 : 90 x 35 mm, 25 cm
006-0603-02 : 125 x 50 mm, 25 cm
006-0603-03 : 160 x 50 mm, 25 cm



Retractors
Retractor, acc. to Milkulicz

Material: Stainless steel

Other Sizes:
006-0607-26 : 90 x 55 mm, 26 cm



Retractors
Retractor, acc. to Kelly

Material: Stainless steel

Other Sizes:
006-0611-01 : 205 x 38 mm, 27.5 cm

RETRACTORS

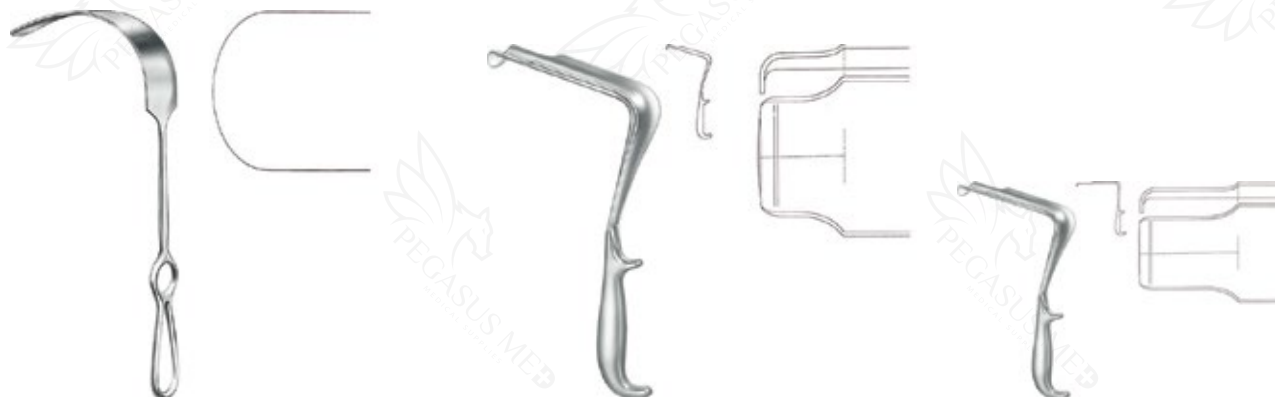

Retractors

Retractor, acc. to Kelly

Material: Stainless steel

Other Sizes:

006-0611-02 : 205 x 57 mm, 27.5 cm

Retractors

Pelvis Retractor

Material: steel 18/8 martinit, antimagnetic, stainless, acid-resistant

Other Sizes:

006-0615-01 : 42 x 60 mm, 29 cm

Retractors

Pelvis Retractor

Material: steel 18/8 martinit, antimagnetic, stainless, acid-resistant

Other Sizes:

006-0615-02 : 193 x 60 mm, 29 cm



Retractors

Pelvis Retractor

Material: steel 18/8 martinit, antimagnetic, stainless, acid-resistant

Other Sizes:

006-0615-03 : 195 x 60 mm, 33 cm

Retractors

Retractor, acc. to Kuemmel

Material: Stainless steel

Other Sizes:

006-0621-28 : 100 x 45 mm, 31 cm

Retractors

Retractor, acc. to Kader, 20 mm wide

Material: Stainless steel

Other Sizes:

006-0623-20 : 28 cm

RETRACTORS

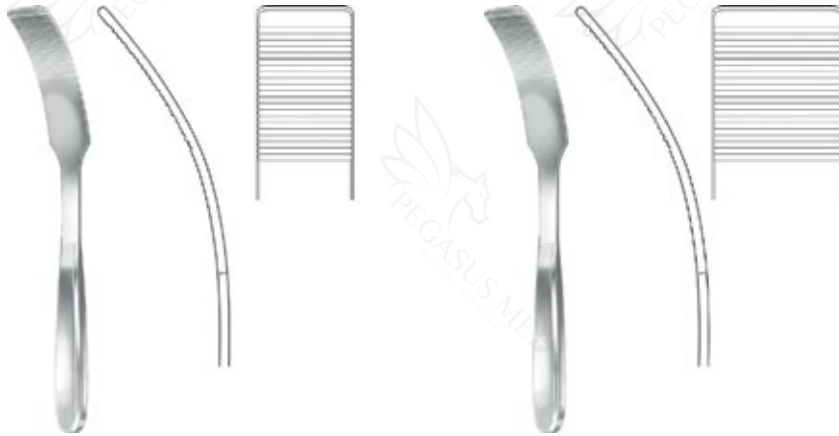

Retractors

Retractor, acc. to Kader, 30 mm wide

Material: Stainless steel

Other Sizes:

006-0623-30 : 28 cm

Retractors

Retractor, acc. to Kader, 40 mm wide

Material: Stainless steel

Other Sizes:

006-0623-40 : 28 cm

Retractors

Retractor, acc. to Collin-Hartmann

Material: steel 18/8 martinit,
antimagnetic, stainless, acid-resistant

Other Sizes:

006-0652-01 : 35 x 29 mm, 15 cm



Retractors

Retractor, acc. to Roux , set, no. 1-3

Material: steel 18/8 martinit,
antimagnetic, stainless, acid-resistant

Other Sizes:

006-0655-00 : 17 cm
006-0655-01 : 14 cm
006-0655-02 : 15 cm
006-0655-03 : 17 cm



Retractors

Retractor, double, acc. to Farabeuf, set

Material: Stainless steel

Other Sizes:

006-0663-00 : 11.5 cm



Retractors

Retractor, double, acc. to Farabeuf, set

Material: Stainless steel

Other Sizes:

006-0665-00 : 15 cm

RETRACTORS



Retractors

Retractor, double, acc. to Mini-Roux

Material: Stainless steel

Other Sizes:

006-0667-06 : 8 x 6 mm, 14.5 cm

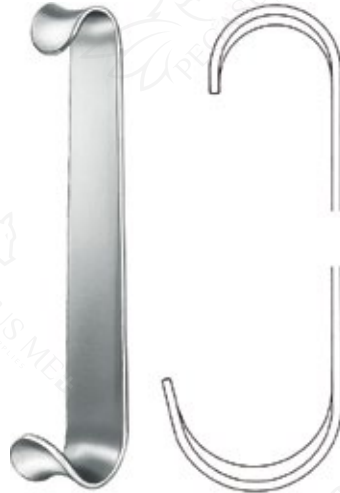

Retractors

Retractor, double, acc. to Baby-Roux

Material: Stainless steel

Other Sizes:

006-0669-13 : 12.5 cm



Retractors

Retractor, double, acc. to Parker, small set

Material: Stainless steel

Other Sizes:

006-0673-01 : 13.5 cm



Retractors

Retractor, double, acc. to Parker, large set

Material: Stainless steel

Other Sizes:

006-0673-02 : 17.5 cm



Retractors

Retractor, double, acc. to Parker-Mott, set

Material: Stainless steel

Other Sizes:

006-0675-00 : 16 cm



Retractors

Retractor, double, acc. to Mathieu, set

Material: Stainless steel

Other Sizes:

006-0683-00 : 20 cm

RETRACTORS



Retractors

Retractor, double, acc. to Parker-Langenbeck, set

Material: Stainless steel

Other Sizes: 006-0687-00 : 21.5 cm



Retractors

Retractor, double, acc. to Golet

Material: Stainless steel

Other Sizes: 006-0695-00 : 19 cm



Retractors

Woundspreader, sharp, 2 x 3 teeth

Material: Stainless steel

Other Sizes: 006-0700-05 : 5 cm

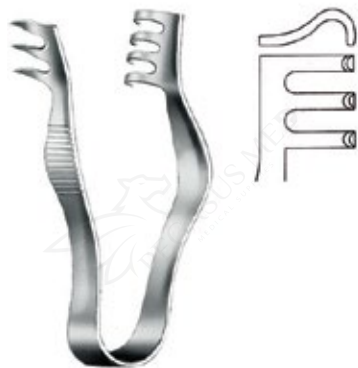

Retractors

Woundspreader, blunt, 2 x 3 teeth

Material: Stainless steel

Other Sizes: 006-0701-05 : 5 cm



Retractors

Woundspreader, sharp, 3 x 4 teeth

Material: Stainless steel

Other Sizes: 006-0702-07 : 7 cm



Retractors

Woundspreader, blunt, 3 x 4 teeth

Material: Stainless steel

Other Sizes: 006-0703-07 : 7 cm

RETRACTORS



Retractors
Woundspreader, sharp, 3 x 4 teeth

Material: Stainless steel

Other Sizes:
006-0704-07 : 7 cm



Retractors
Woundspreader, blunt, 3 x 4 teeth

Material: Stainless steel

Other Sizes:
006-0705-07 : 7 cm



Retractors
Woundspreader, acc. to Logan, sharp, 3 x 3 teeth

Material: Stainless steel

Other Sizes:
006-0708-04 : 4 cm

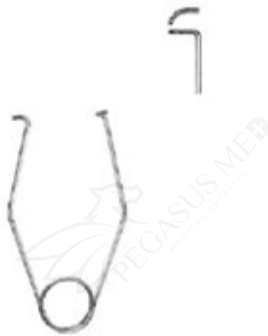

Retractors
N/A

Material: Stainless steel

Other Sizes:
006-0709-30 : 3 cm



Retractors
N/A

Material: Stainless steel

Other Sizes:
006-0709-40 : 4 cm

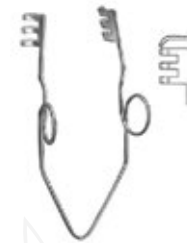

Retractors
N/A

Material: Stainless steel

Other Sizes:
006-0709-55 : 5.5 cm

RETRACTORS



Retractors

N/A

Material: Stainless steel

Other Sizes:

006-0710-06 : 6 cm

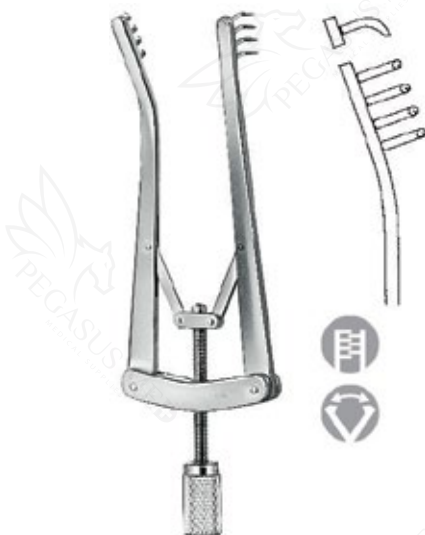

Retractors

Woundspreader, acc. to Alm, sharp,
4 x 4 teeth

Material: Stainless steel

Other Sizes:

006-0714-07 : 7 cm
006-0714-10 : 10 cm



Retractors

Woundspreader, acc. to Alm, blunt,
4 x 4 teeth

Material: Stainless steel

Other Sizes:

006-0715-07 : 7 cm
006-0715-10 : 10 cm



Retractors

Woundspreader, blunt, 4 x 4 teeth

Material: Stainless steel

Other Sizes:

006-0717-10 : 10 cm

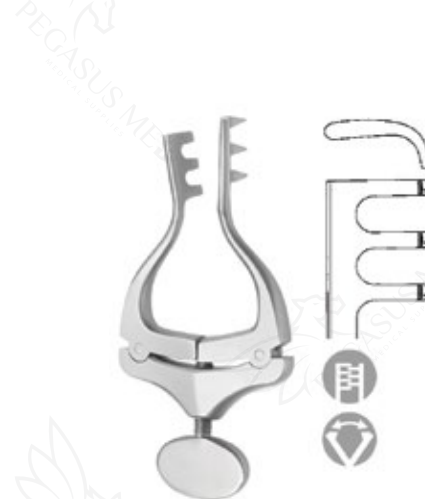

Retractors

Spreader, acc. to Jansen, blunt, 3 x 3 teeth

Material: Stainless steel

Other Sizes:

006-0723-10 : 10 cm
006-0723-20 : 10

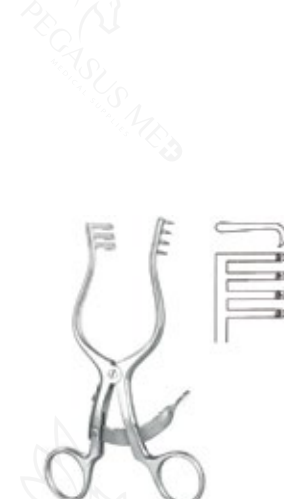

Retractors

Woundspreader, sharp, 3 x 4 teeth

Material: Stainless steel

Other Sizes:

006-0725-14 : 13.5 cm

RETRACTORS



Retractors
Woundspreader, blunt, 3 x 4 teeth

Material: Stainless steel

Other Sizes:
006-0727-14 : 13.5 cm

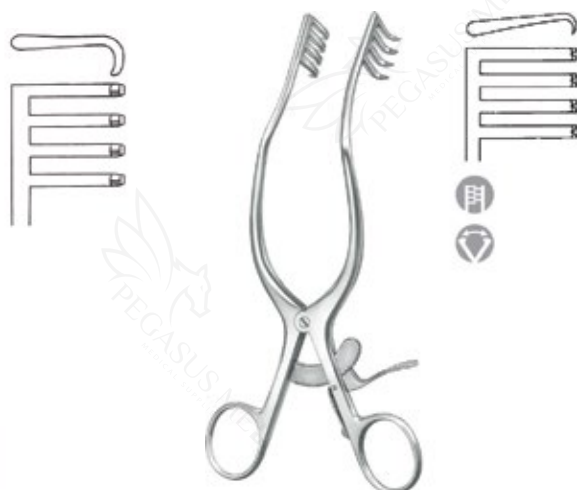

Retractors
Spreader, acc. to Adson-Anderson, 4 x 4 teeth

Material: Stainless steel

Other Sizes:
006-0732-20 : 20 cm



Retractors
Woundspreader, acc. to Travers, blunt

Material: Stainless steel

Other Sizes:
006-0733-21 : 21.5 cm

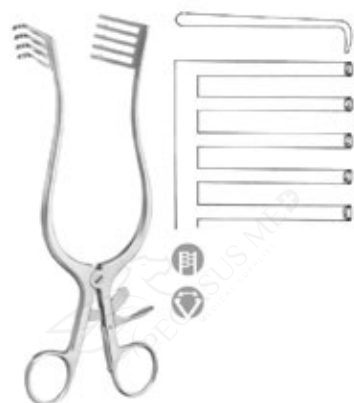

Retractors
Spreader, acc. to Norfolk/Norwich, blunt

Material: Stainless steel

Other Sizes:
006-0733-22 : 22 cm

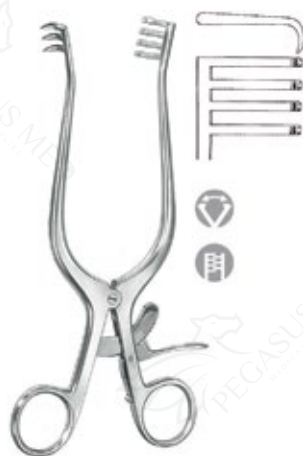

Retractors
Woundspreader, sharp, 3 x 4 teeth

Material: Stainless steel

Other Sizes:
006-0734-20 : 20 cm
006-0734-24 : 24 cm
006-0734-26 : 24.5 cm



Retractors
Woundspreader, semi-sharp, 3 x 4 teeth

Material: Stainless steel

Other Sizes:
006-0734-21 : 20 cm
006-0736-24 : 24 cm

RETRACTORS



Retractors
Woundspreader, blunt, 3 x 4 teeth

Material: Stainless steel

Other Sizes:	
006-0735-20	20 cm
006-0735-24	24 cm
006-0735-26	25.5 cm

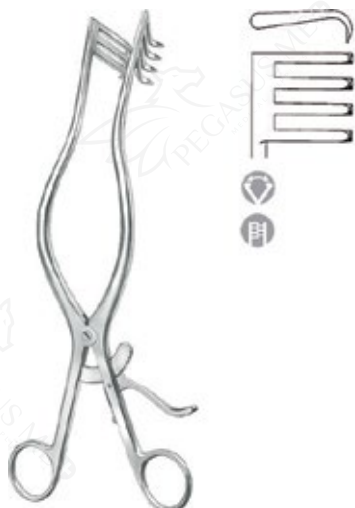

Retractors
Spreader, acc. to Adson, sharp, 3 x 4 teeth

Material: Stainless steel

Other Sizes:	
006-0736-26	26 cm
006-0736-27	26 cm



Retractors
Spreader, acc. to Adson, blunt, 3 x 4 teeth

Material: Stainless steel

Other Sizes:	
006-0737-26	26 cm

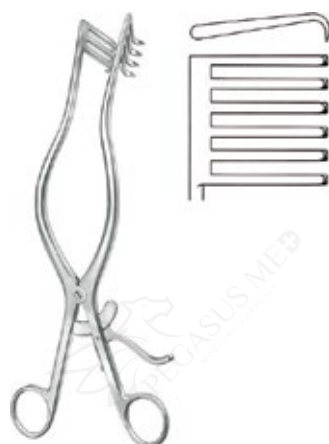

Retractors
Spreader, acc. to Adson, sharp, 6 x 6 teeth

Material: Stainless steel

Other Sizes:	
006-0738-25	29 cm
006-0738-26	29 cm

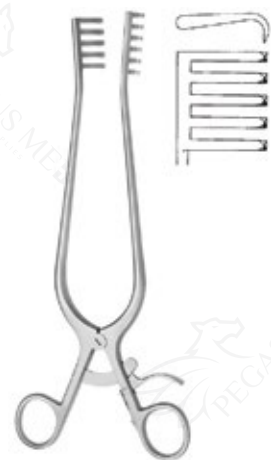

Retractors
Spreader, acc. to Adson, semi-sharp, 5 x 6 teeth

Material: Stainless steel

Other Sizes:	
006-0738-27	25.5 cm

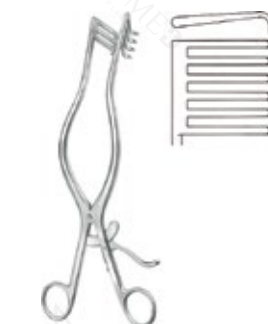

Retractors
Spreader, acc. to Adson, blunt, 6 x 6 teeth

Material: Stainless steel

Other Sizes:	
006-0739-26	29 cm

RETRACTORS



Retractors
Spreader, sharp, 3 x 4 teeth, 20 mm

Material: Stainless steel

Other Sizes:
006-0740-13 : 13 cm

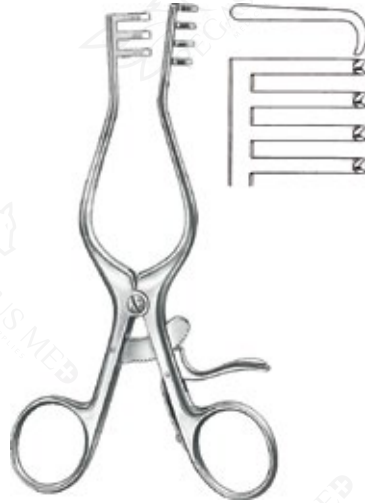

Retractors
Spreader, blunt, 3 x 4 teeth, 20 mm

Material: Stainless steel

Other Sizes:
006-0741-13 : 13 cm

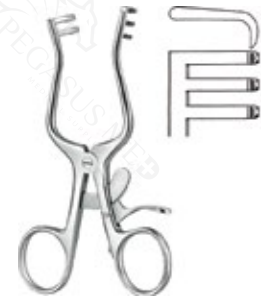

Retractors
Woundspreader, semi-sharp, 2 x 3 teeth

Material: Stainless steel

Other Sizes:
006-0747-10 : 11 cm



Retractors
Woundspreader, sharp, 2 x 3 teeth

Material: Stainless steel

Other Sizes:
006-0748-10 : 11 cm



Retractors
Woundspreader, blunt, 2 x 3 teeth

Material: Stainless steel

Other Sizes:
006-0749-10 : 11 cm



Retractors
Woundspreader, sharp, 3 x 4 teeth

Material: Stainless steel

Other Sizes:
006-0750-13 : 13.5 cm
006-0750-16 : 16 cm

RETRACTORS

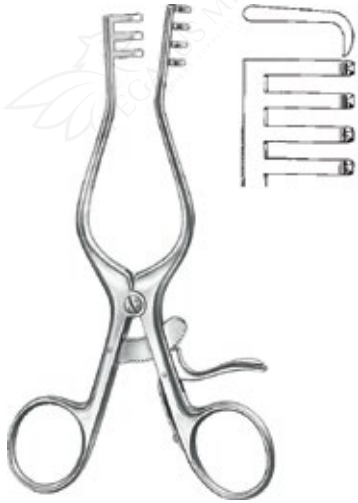

Retractors
Woundspreader, semi-sharp, 3 x 4 teeth

Material: Stainless steel

Other Sizes:

006-0750-14	13.5 cm
006-0750-17	16 cm

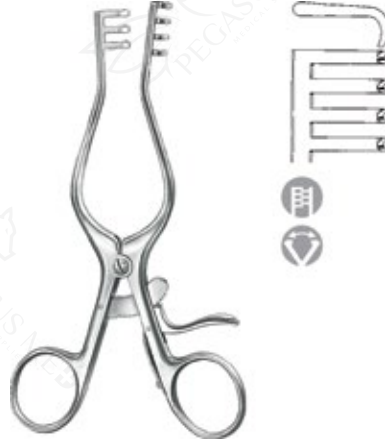

Retractors
Woundspreader, blunt, 3 x 4 teeth

Material: Stainless steel

Other Sizes:

006-0751-13	13.5 cm
006-0751-16	16 cm



Retractors
Spreader, acc. to Weitacc.
to Laner-Wullstein, sharp, 3 x 3 teeth

Material: Stainless steel

Other Sizes:

006-0752-13	13 cm
-------------	-------



Retractors
Spreader, acc. to Weitacc.
to Laner-Wullstein, blunt, 3 x 3 teeth

Material: Stainless steel

Other Sizes:

006-0753-13	13 cm
-------------	-------



Retractors
Spreader, acc. to Mollison, sharp, 4 x 4 teeth

Material: Stainless steel

Other Sizes:

006-0754-15	15.5 cm
-------------	---------



Retractors
Spreader, acc. to Plester, blunt, 2 x 2 teeth

Material: Stainless steel

Other Sizes:

006-0755-13	13 cm
-------------	-------

RETRACTORS



Retractors
Spreader, acc. to Plester, sharp, 2 x 2 teeth

Material: Stainless steel

Other Sizes:
006-0756-13 : 13 cm



Retractors
Spreader, acc. to Plester, blunt, left

Material: Stainless steel

Other Sizes:
006-0757-11 : 10.5 cm



Retractors
Spreader, acc. to Plester, blunt, right

Material: Stainless steel

Other Sizes:
006-0759-11 : 10.5 cm



Retractors
Spreader, acc. to William, right

Material: Stainless steel

Other Sizes:
006-0761-05 : 1 x 5 cm
006-0761-06 : 1 x 6 cm
006-0761-07 : 1 x 7 cm



Retractors
Spreader, acc. to William, left

Material: Stainless steel

Other Sizes:
006-0762-05 : 1 x 5 cm
006-0762-06 : 1 x 6 cm
006-0762-07 : 1 x 7 cm

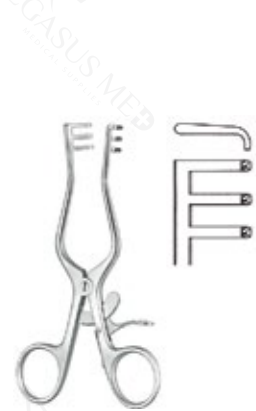

Retractors
Woundspreader, blunt, 3 x 3 teeth

Material: Stainless steel

Other Sizes:
006-0765-13 : 13.5 cm

RETRACTORS



Retractors

Spreader, acc. to Hartmann, 3 x 4 teeth, blunt

Material: Stainless steel

Other Sizes: 006-0767-00 : 25 cm



Retractors

Center blade for 006-0767-00

Material: Stainless steel

Other Sizes: 006-0767-01 : N/A



Retractors

Woundspreader, full blade

Material: Stainless steel

Other Sizes: 006-0767-13 : 13.5 cm

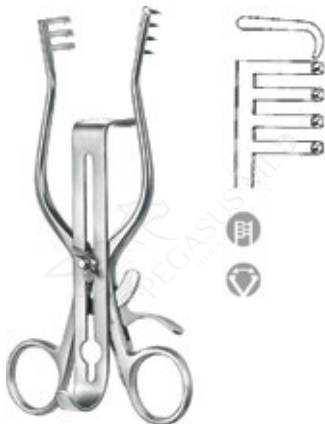

Retractors

Spreader, acc. to Henley, blunt, 3 x 4 teeth

Material: Stainless steel

Other Sizes: 006-0768-00 : 16 cm



Retractors

Center Blade for 15-768-00-07, 19 x 17 mm

Material: Stainless steel

Other Sizes: 006-0768-19 : 16 cm



Retractors

Center Blade for 15-768-00-07, 25 x 17 mm

Material: Stainless steel

Other Sizes: 006-0768-25 : 16 cm

RETRACTORS



Retractors

Center Blade for 15-768-00-07,
32 x 17 mm

Material: Stainless steel

Other Sizes:

006-0768-32 : 16 cm



Retractors

Spreader, acc. to Henley, sharp,
3 x 4 teeth

Material: Stainless steel

Other Sizes:

006-0769-00 : 16 cm

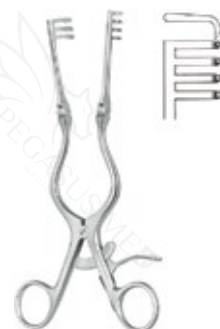

Retractors

Spreader, acc. to Adson, sharp,
3 x 4 teeth

Material: Stainless steel

Other Sizes:

006-0770-13 : 13.5 cm
006-0770-16 : 16.5 cm
006-0770-20 : 21 cm
006-0770-26 : 24.5 cm



Retractors

Spreader, acc. to Adson, blunt,
3 x 4 teeth

Material: Stainless steel

Other Sizes:

006-0771-13 : 13.5 cm
006-0771-16 : 16.5 cm
006-0771-20 : 21 cm
006-0771-26 : 24.5 cm



Retractors

Spreader, acc. to Adson, semi-sharp,
3 x 4 teeth

Material: Stainless steel

Other Sizes:

006-0772-13 : 14 cm
006-0772-16 : 16.5 cm
006-0772-20 : 21 cm
006-0772-26 : 24.5 cm



Retractors

Spreader, acc. to Adson, blunt,
3 x 4 teeth

Material: Stainless steel

Other Sizes:

006-0773-13 : 14 cm

RETRACTORS



Retractors
 Spreader, acc. to Cloward, complete

Material: Stainless steel

Other Sizes:
 006-0774-00 : 25 cm



Retractors
 Spreader, acc. to Cloward, only, for 006-0774-00

Material: Stainless steel

Other Sizes:
 006-0774-25 : 25 cm



Retractors
 Blade for spreader, acc. to Cloward, fenestrated

Material: Stainless steel

Other Sizes:
 006-0774-40 : 40 mm
 006-0774-45 : 45 mm
 006-0774-50 : 50 mm
 006-0774-55 : 55 mm
 006-0774-60 : 60 mm



Retractors
 Spreader, acc. to Cloward, complete

Material: Stainless steel

Other Sizes:
 006-0775-00 : 15 cm



Retractors
 Spreader, acc. to Cloward, only, for 006-0775-00

Material: Stainless steel

Other Sizes:
 006-0775-15 : 15 cm



Retractors
 Blade for Spreader, acc. to Cloward, smooth

Material: Stainless steel

Other Sizes:
 006-0775-40 : 40 mm
 006-0775-45 : 45 mm
 006-0775-50 : 50 mm
 006-0775-55 : 55 mm
 006-0775-60 : 60 mm

RETRACTORS



Retractors
 Spreader, acc. to Beckmann, sharp,
 4 x 4 teeth

Material: Stainless steel

Other Sizes:
 006-0776-31 : 32 cm
 006-0776-32 : 31.5 cm

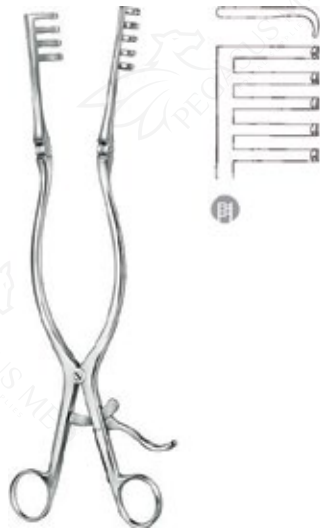

Retractors
 Spreader, acc. to Adson, blunt,
 4 x 5 teeth

Material: Stainless steel

Other Sizes:
 006-0777-32 : 33 cm



Retractors
 Spreader, acc. to Adson, semi-sharp,
 4 x 5 teeth

Material: Stainless steel

Other Sizes:
 006-0777-33 : 33 cm



Retractors
 Woundspreader, blunt, 4 x 4 teeth

Material: Stainless steel

Other Sizes:
 006-0778-00 : 30.5 cm



Retractors
 Woundspreader, sharp, 4 x 4 teeth

Material: Stainless steel

Other Sizes:
 006-0778-01 : 30.5 cm



Retractors
 Woundspreader, blunt, 4 x 4 teeth

Material: Stainless steel

Other Sizes:
 006-0778-02 : 30.5 cm

RETRACTORS

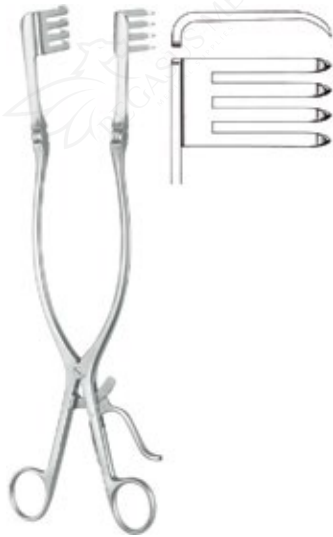

Retractors
Woundspreader, sharp, 4 x 4 teeth

Material: Stainless steel

Other Sizes:
006-0778-03 : 30.5 cm



Retractors
Spreader, acc. to Beckmann-Eaton,
7 x 7 teeth

Material: Stainless steel

Other Sizes:
006-0778-32 : 32 cm



Retractors
Woundspreader, 6 x 6 teeth, sharp, right

Material: Stainless steel

Other Sizes:
006-0790-01 : 28.5 cm



Retractors
Woundspreader, 6 x 6 teeth, sharp, left

Material: Stainless steel

Other Sizes:
006-0790-02 : 28.5 cm



Retractors
Spreader, acc. to Vickers, low-profile

Material: steel 18/8 martinit,
antimagnetic, stainless, acid-resistant

Other Sizes:
006-0792-00 : 6 cm

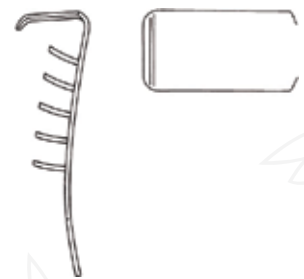

Retractors
Blade for spreader, acc. to Vickers

Material: steel 18/8 martinit,
antimagnetic, stainless, acid-resistant

Other Sizes:
006-0792-01 : 10 x 18 mm
006-0792-02 : 10 x 12 mm

RETRACTORS



Retractors
Spreader, low-profile, 3 x 3 teeth

Material: steel 18/8 martinit,
antimagnetic, stainless, acid-resistant

Other Sizes:
006-0793-00 : 9 cm



Retractors
Spreader, low-profile, full blunt

Material: steel 18/8 martinit,
antimagnetic, stainless, acid-resistant

Other Sizes:
006-0794-00 : 7.5 cm



Retractors
Finger woundspreader, acc. to Vickers

Material: steel 18/8 martinit,
antimagnetic, stainless, acid-resistant

Other Sizes:
006-0798-01 : 5 cm



Retractors
Woundspreader, acc. to Joll, sharp

Material: Stainless steel

Other Sizes:
006-0801-00 : 15.5 cm



Retractors
Woundspreader, acc. to Gelpi, 1 x 1 teeth

Material: Stainless steel

Other Sizes:
006-0802-13 : 13 cm



Retractors
Woundspreader, acc. to Gelpi, 1 x 1 teeth

Material: Stainless steel

Other Sizes:
006-0802-18 : 18 cm

RETRACTORS



Retractors

Woundspreader, acc. to Gelpi, 1 x 1 teeth

Material: Stainless steel

Other Sizes:

006-0804-18 : 18.5 cm



Retractors

Abdominal retractor, acc. to Collin-Baby

Material: Stainless steel

Other Sizes:

006-0820-00 : 18 cm



Retractors

Abdominal retractor, acc. to Collin

Material: Stainless steel

Other Sizes:

006-0822-22 : 20 cm



Retractors

Abdominal retractor, acc. to Collin

Material: Stainless steel

Other Sizes:

006-0823-00 : 22.5 cm
006-0824-00 : 22.5 cm



Retractors

Abdominal retractor, acc. to Collin

Material: Stainless steel

Other Sizes:

006-0826-00 : 31 cm



Retractors

Abdominal retractor, acc. to Ricard, complete

Material: Stainless steel

Other Sizes:

006-0828-00 : 28 cm

RETRACTORS



Retractors

Frame, only, for retractor, acc. to Ricard

Material: Stainless steel

Other Sizes:

006-0828-01 : 19 cm



Retractors

Abdominal retractor, acc. to Ricard, complete, large blades

Material: Stainless steel

Other Sizes:

006-0830-00 : 30 cm



Retractors

Center blade

Material: Stainless steel

Other Sizes:

006-0830-02 : 55 x 70 mm
006-0830-04 : 80 x 90 mm



Retractors

Changeable blade, 1 piece

Material: Stainless steel

Other Sizes:

006-0839-18 : 18 x 40 mm
006-0839-27 : 27 x 40 mm
006-0839-38 : 38 x 60 mm
006-0839-40 : 40 x 80 mm
006-0839-45 : 45 x 80 mm
006-0839-60 : 60 x 80 mm

Retractors

Changeable blade, 1 piece

Material: Stainless steel

Other Sizes:

006-0839-50 : 50 x 70 mm
006-0839-52 : 52 x 110 mm
006-0839-90 : 50 x 58 mm
006-0839-92 : 60 x 80 mm

Retractors

Changeable blade, 1 piece

Material: Stainless steel

Other Sizes:

006-0839-70 : 70 x 55 mm
006-0839-80 : 75 x 90 mm
006-0839-94 : 72 x 85 mm

RETRACTORS



Retractors

Abdominal retractor, acc. to Gosset

Material: Stainless steel

Other Sizes:

006-0840-00 : 12.5 cm

Retractors

Abdominal retractor, acc. to Gosset

Material: Stainless steel

Other Sizes:

006-0844-00 : 16.5 cm

Retractors

Abdominal retractor, acc. to Gosset

Material: Stainless steel

Other Sizes:

006-0846-00 : 18.5 cm



Retractors

Abdominal Retractor, acc. to Balfour-Baby

Material: Stainless steel

Other Sizes:

006-0850-00 : 12.5 cm



Retractors

Abdominal Retractor, acc. to Balfour,
wire blades

Material: Stainless steel

Other Sizes:

006-0852-00 : 20 cm



Retractors

Abdominal Retractor, acc. to Balfour,
full blades

Material: Stainless steel

Other Sizes:

006-0854-00 : 20 cm

RETRACTORS



Retractors

Center Blade, 100 x 70 mm, for 006-0856-00

Material: Stainless steel

Other Sizes:
006-0856-90 : N/A



Retractors

Center Blade, for 006-0856-00

Material: Stainless steel

Other Sizes:
006-0856-91 : 100 x 60 mm



Retractors

Abdominal Retractor, acc. to Balfour, wire blades

Material: Stainless steel

Other Sizes:
006-0858-00 : N/A



Retractors

Center Blade, acc. to Balfour

Material: Stainless steel

Other Sizes:
006-0859-01 : 45 x 80 mm
006-0859-02 : 68 x 85 mm



Retractors

Center Blade, acc. to Balfour

Material: Stainless steel

Other Sizes:
006-0859-06 : 40 x 68 mm
006-0859-05 : 68 x 85 mm



Retractors

Abdominal Retractor, acc. to Balfour, US-type

Material: Stainless steel

Other Sizes:
006-0860-00 : ...

RETRACTORS



Retractors

Wire blades, acc. to Balfour, pair

Material: Stainless steel

Other Sizes:

006-0860-06	60 mm deep
006-0860-08	80 mm deep



Retractors

Abdominal retractor, acc. to O'Sullivan-O'Connor

Material: Stainless steel

Other Sizes:

006-0868-00	...
-------------	-----



Retractors

Abdominal retractor, acc. to KirsChner, oval, complete

Material: Stainless steel

Other Sizes:

006-0882-00	...
-------------	-----



Retractors

Frame, acc. to KirsChner, oval

Material: Stainless steel

Other Sizes:

006-0882-30	300 x 240 mm
-------------	--------------



Retractors

Abdominal retractor, acc. to KirsChner, angled, complete

Material: Stainless steel

Other Sizes:

006-0884-00	...
-------------	-----



Retractors

Frame, acc. to KirsChner, angled

Material: Stainless steel

Other Sizes:

006-0884-24	240 x 240 mm
-------------	--------------

RETRACTORS

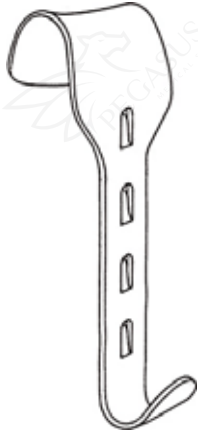

Retractors

Hook on blade, acc. to KirsChner

Material: Stainless steel

Other Sizes:

006-0889-40	40 x 55 mm
006-0889-50	50 x 65 mm
006-0889-60	60 x 85 mm
006-0889-78	78 x 65 mm
006-0889-80	80 x 90 mm



Retractors

Hook on blade, acc. to KirsChner

Material: Stainless steel

Other Sizes:

006-0889-98	98 x 50 mm
006-0889-99	105 x 35 mm



Retractors

Laminectomy retractor frame, acc. to Scoville

Material: Stainless steel

Other Sizes:

006-0906-00	150 mm
-------------	--------



Retractors

Hook blade, acc. to Scoville, blunt

Material: Stainless steel

Other Sizes:

006-0906-01	50 mm
006-0906-02	70 mm



Retractors

Hook blade, acc. to Scoville, sharp

Material: Stainless steel

Other Sizes:

006-0906-06	50 mm
006-0906-07	70 mm



Retractors

Blade, acc. to Scoville, serrated

Material: Stainless steel

Other Sizes:

006-0906-11	60 x 25 mm
006-0906-12	64 x 50 mm
006-0906-13	88 x 25 mm

RETRACTORS



Retractors

Hook blade, acc. to Taylor, 4 prongs

Material: Stainless steel

Other Sizes:

006-0906-41	48 x 50 mm
006-0906-42	64 x 50 mm
006-0906-43	64 x 64 mm
006-0906-44	80 x 57 mm



Retractors

Hook blade, acc. to Scoville, 4 prongs

Material: Stainless steel

Other Sizes:

006-0906-46	41 x 38 mm
006-0906-47	67 x 44 mm



Retractors

aminectomy retractor frame, acc. to Scoville-Haverfield

Material: Stainless steel

Other Sizes:

006-0906-50	150 mm
-------------	--------



Retractors

Martin-Arm-System '99

Material: Stainless steel

Other Sizes:

006-0910-01	N/A
-------------	-----



Retractors

Optic Holder, Ø 5 and 10 mm, for 006-0910-01

Material: all other, not specially marked material types

Other Sizes:

006-0910-10	N/A
-------------	-----



Retractors

Universal-Fixation for 006-0910-01

Material: Stainless steel

Other Sizes:

006-0910-50	N/A
-------------	-----

RETRACTORS

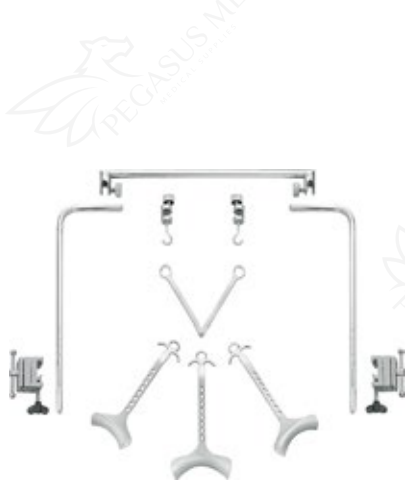

Retractors
Martin RoChard system, complete

Material: Stainless steel

Other Sizes:
006-0917-00 : N/A



Retractors
Lateral holding arm for 006-0917-00

Material: Stainless steel

Other Sizes:
006-0917-01 : N/A



Retractors
Cross rod, hexagon for 006-0917-00

Material: Stainless steel

Other Sizes:
006-0917-02 : N/A



Retractors
Slideable fixation for cross rod

Material: Stainless steel

Other Sizes:
006-0917-03 : N/A



Retractors
Fixation for RoChard retractors

Material: Stainless steel

Other Sizes:
006-0917-04 : 18.5 cm



Retractors
Retractor, acc. to RoChard,

Material: Stainless steel

Other Sizes:
006-0917-10 : 50 x 105 mm
006-0917-12 : 50 x 120 mm
006-0917-15 : 50 x 160 mm

RETRACTORS



Retractors

Abdominal spatula, malleable, 33 cm

Material: Stainless steel

Other Sizes:

006-0963-01	30 mm
006-0963-02	40 mm
006-0963-03	50 mm



Retractors

Abdominal spatula, acc. to Haberer

Material: Stainless steel

Other Sizes:

006-0971-00	17-25 mm, 20 cm
006-0971-01	25-30 mm, 28 cm
006-0971-02	37-45 mm, 30 cm



Retractors

Spatula, acc. to Martin, malleable, 20 cm

Material: Stainless steel

Other Sizes:

006-0975-06	6.5 mm
006-0975-09	9.5 mm
006-0975-13	13 mm
006-0975-16	16 mm
006-0975-19	19 mm
006-0975-25	25 mm



Retractors

Blade only for 006-0823-00

Material: Stainless steel

Other Sizes:

015-0839-38	38 x 55 mm
-------------	------------



Retractors

Center Blade, for 006-0824-00

Material: Replacement part

Other Sizes:

015-0839-45	50 x 75 mm
-------------	------------



Retractors

Center blade, for 006-0826-00

Material: Replacement part

Other Sizes:

015-0839-60	60 x 80 mm
-------------	------------



PEGASUSMED

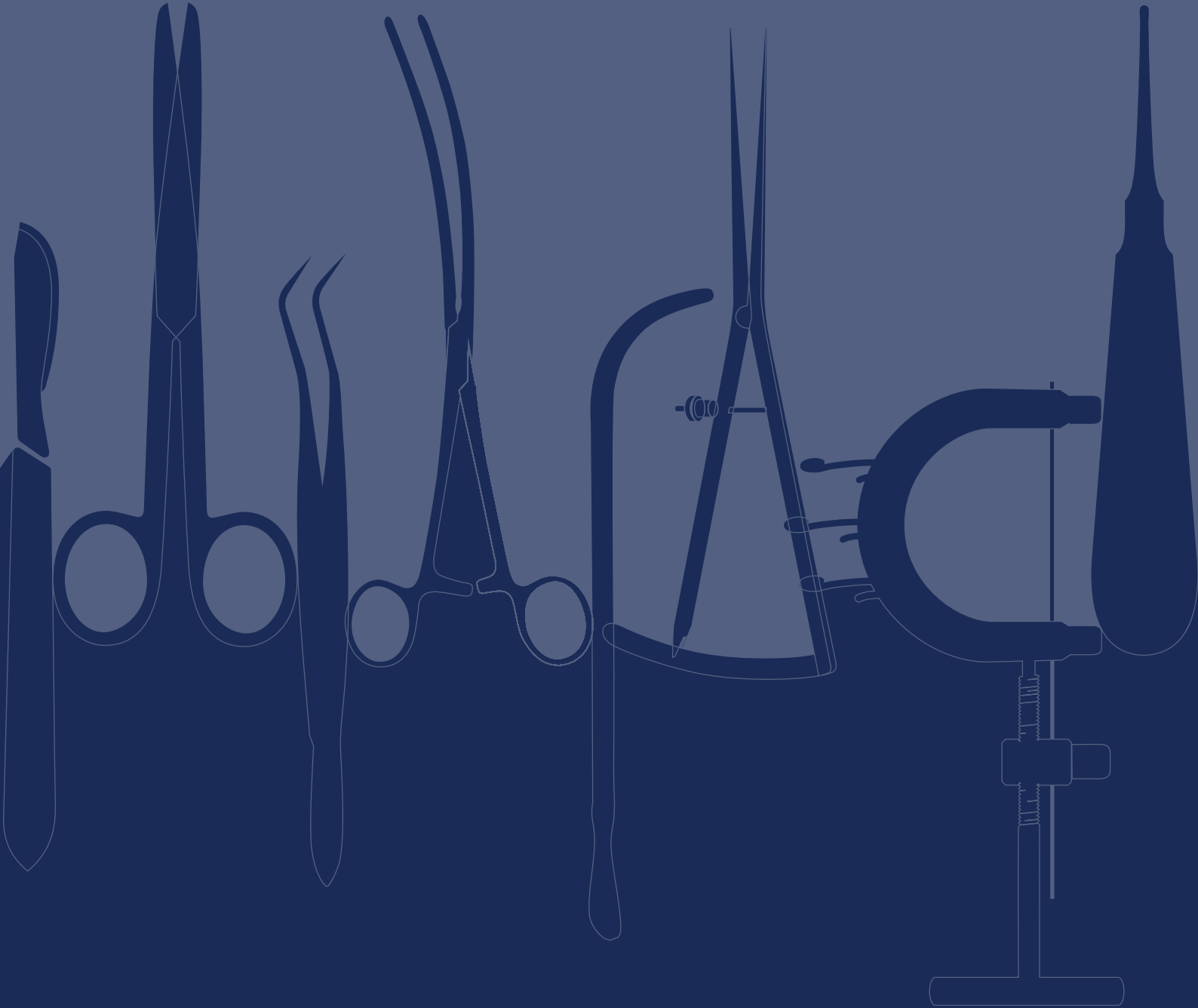

Manufacturer & Exporters of Quality Surgical, Dental Instruments, Hospital Equipments & Scissors of all sorts.

Tel: +44 191 670 9552
info@pegasusmed.co.uk
www.pegasusmed.co.uk



77 one three Sixty Jesmond
Newcastle upon Tyne
NE2 1DQ
United Kingdom

