



**CONCRETE SAW
OPERATOR'S MANUAL**

CC150XL-EE6 Series

CC125BXL

CC148HXL

CC165BVXL

CC165LXL

October, 2019

Part #: 1802698

TABLE OF CONTENTS

Table of Contents

Introduction	6
Early Entry Technology	6
CC125BXL-EE6 Components	7
<i>CC148HXL-EE6 / CC165BVXL-EE6 / CC165LXL-EE6 Components</i>	8
CC150XL-EE6 Series Dimensions	9
CC150XL-EE6 Series Specifications	10
CC150XL-EE6 Electric Motor Specifications	11
CC150XL-EE6 Gas Engine Specifications	11
Safety	12
Safety Alerts	12
Proposition 65	12
Respiratory Hazards	12
General Safety	13
Blade Safety	13
Spring Box Safety	14
Fuel Safety	14
Engine/Motor Safety	14
Cutting Safety	15
Belt Safety	15
Transporting Safety	15
Lifting Safety	15
Operating	16
General Operating Precautions	16
Handlebars	16
Handlebars	16
Adjusting the Handlebars	16
Front Pointer	16
Adjusting the Front Pointer	16
Diamond Blades	17
Inspecting the Blade	17
Blade Speed	17
Installing the Blade	17
Removing the Blade	19
Raising and Lowering the Saw/Blade	19
Raising the Saw	19
Lowering the Saw/Blade	19
Spring Box Assembly	19
Motor	20
Prior to Starting the Motor	20
Starting the Motor	20
Stopping the Motor	20
Engines	20
Starting the Honda engine	20
Stopping the Honda Engine	21
Starting the Vanguard Engine	21
Stopping the Vanguard Engine	22
Starting the Lifan Engine	22
Stopping the Lifan Engine	23
Fueling the saw	23
Cutting	23

TABLE OF CONTENTS

Cutting Guides.....	23
Straight Line Cutting.....	23
Helpful Hints Prior to Cutting.....	23
Tasks Prior to Cutting.....	24
Making a Cut.....	24
Continuing a Partial-Cut.....	24
Finishing a Cut.....	24
Maintenance.....	25
General.....	25
Pre Maintenance Preparations.....	25
General Cleaning.....	25
Cleaning Techniques.....	25
Starter Switch Control Box.....	25
Motor.....	25
Part Lubrication.....	26
Post Cleaning.....	26
Service Schedule.....	27
Daily Service.....	28
Handlebars.....	28
Skid Plate.....	28
Replacing the Skid Plate.....	28
Lubricate the Blade Shaft Bearings.....	28
Inspect the Drive Belt.....	28
Belt Tensioning.....	28
Tensioning the Drive Belts.....	29
Replacing the Drive Belts.....	29
Check Engine Oil Level.....	29
Check Fuel Level.....	29
Check Air Filter.....	29
100 Hour Service.....	29
Clean the Air Filter.....	29
Replace the Engine Oil.....	30
Clean the Sediment Cup.....	30
Check and Adjust Spark Plug.....	30
Clean the Spark Arrester.....	31
Honda & Lifan Engines.....	31
Vanguard Engine.....	31
Yearly Service.....	31
Replace the Air Filter.....	31
Replace the Spark Plug.....	32
General Maintenance.....	32
Motor.....	32
Disconnecting the Power to the Motor.....	32
Inner Blade Flange.....	32
Installing the Inner Blade Flange.....	32
Removing the Inner Blade Flange.....	32
Wheels.....	32
Replacing the Front Wheels.....	33
Replacing the Rear Wheels.....	33
Lifting and Transporting.....	34

TABLE OF CONTENTS

Lifting	34
Transporting	34
Storing	34
Disposal	34
Appendix A	38
Troubleshooting	38
Appendix B	40
Belt Tension Specifications	40
Power Cord Specifications	40
Appendix C	41
Additional Resources	41
Appendix D	42
Model and Serial Numbers.....	42

Introduction

Welcome to the Diamond Products family and thank you for choosing Diamond Products equipment. At Diamond Products we are driven to ensure you are completely satisfied with your product and continually strive to improve our product line so that we can offer you the best possible equipment in the industry.

This operator's manual is a critical document that provides pertinent information regarding the safety, operation, maintenance, and care of your new equipment. Keep this manual available at all times. Operate the equipment and all of its components according to this manual. Failure to comply with and understand the following safety, operation and maintenance instructions can result in serious injuries and/or death. All operators must be properly trained or supervised by experienced personnel prior to using this saw and should understand the risks and hazards involved. Diamond Products discourages improper or unintended equipment usage and cannot be held liable for any resulting damages.

Equipment modifications should be made by Diamond Products to ensure safety and design. Any modifications made by the owner(s) are not the responsibility of Diamond Products and void all equipment warranties if a problem arises as a result of the modification.

Refer to the Diamond Products Parts List for additional information and part diagrams. Refer to the engine/motor manufacturer as the primary source for all safety, operations, and maintenance instructions regarding the engine/motor. Prior to operating, record the saw's serial number, and the engine/motor's model and serial numbers in Appendix D.

Early Entry Technology

Timing is a critical factor when it comes to concrete. It is crucial that the jointing process be completed as early as possible to help control cracking from stresses created as the concrete cures and dries. The Diamond Products Early Entry saws were developed as high speed, light weight, up cut saws to allow for this type of operation. They incorporate a spring box technology that uses a skid plate to prevent chipping and spalling which can lead to an unsightly finished product. The spring box also keeps the dust from the cutting process down and when combined with a dust collection system can almost eliminate the dust altogether. Proper use of these saws will provide a beautiful end product that will last for years.

INTRODUCTION

CC125BXL-EE6 Components

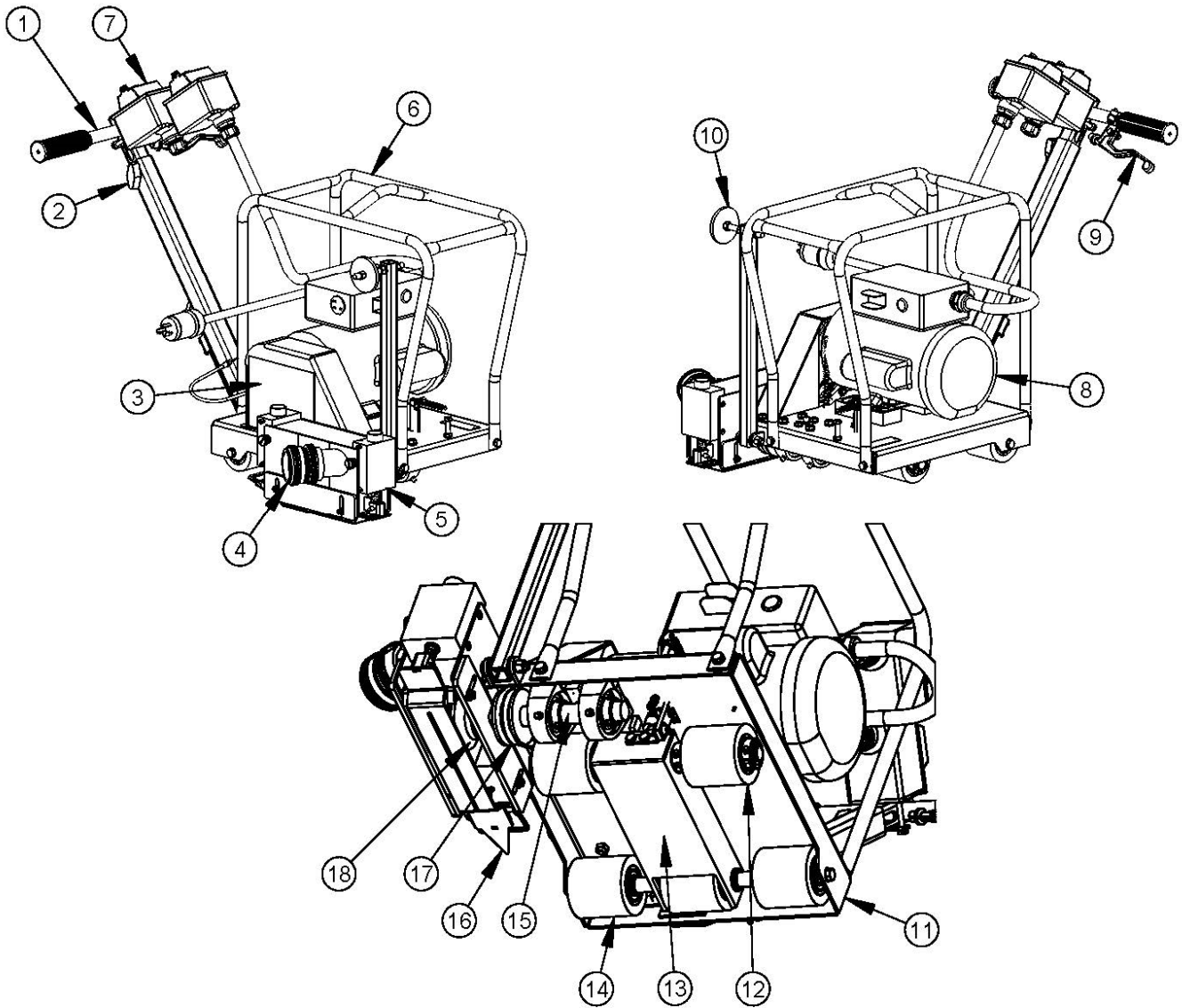

1. Handlebar
2. Handlebar Locking Knobs
3. Belt Guard
4. Vacuum Hose Attachment
5. Spring Box
6. Lift Cage
7. Motor Controller
8. Motor
9. Handlebar Lever

10. Front Pointer
11. Frame Base
12. Front Wheels
13. Front Axle
14. Rear Wheels
15. Blade Shaft
16. Spring Loaded Skid Plate
17. Belt Drive
18. Blade Flange

INTRODUCTION

CC148HXL-EE6 / CC165BVXL-EE6 / CC165LXL-EE6 Components

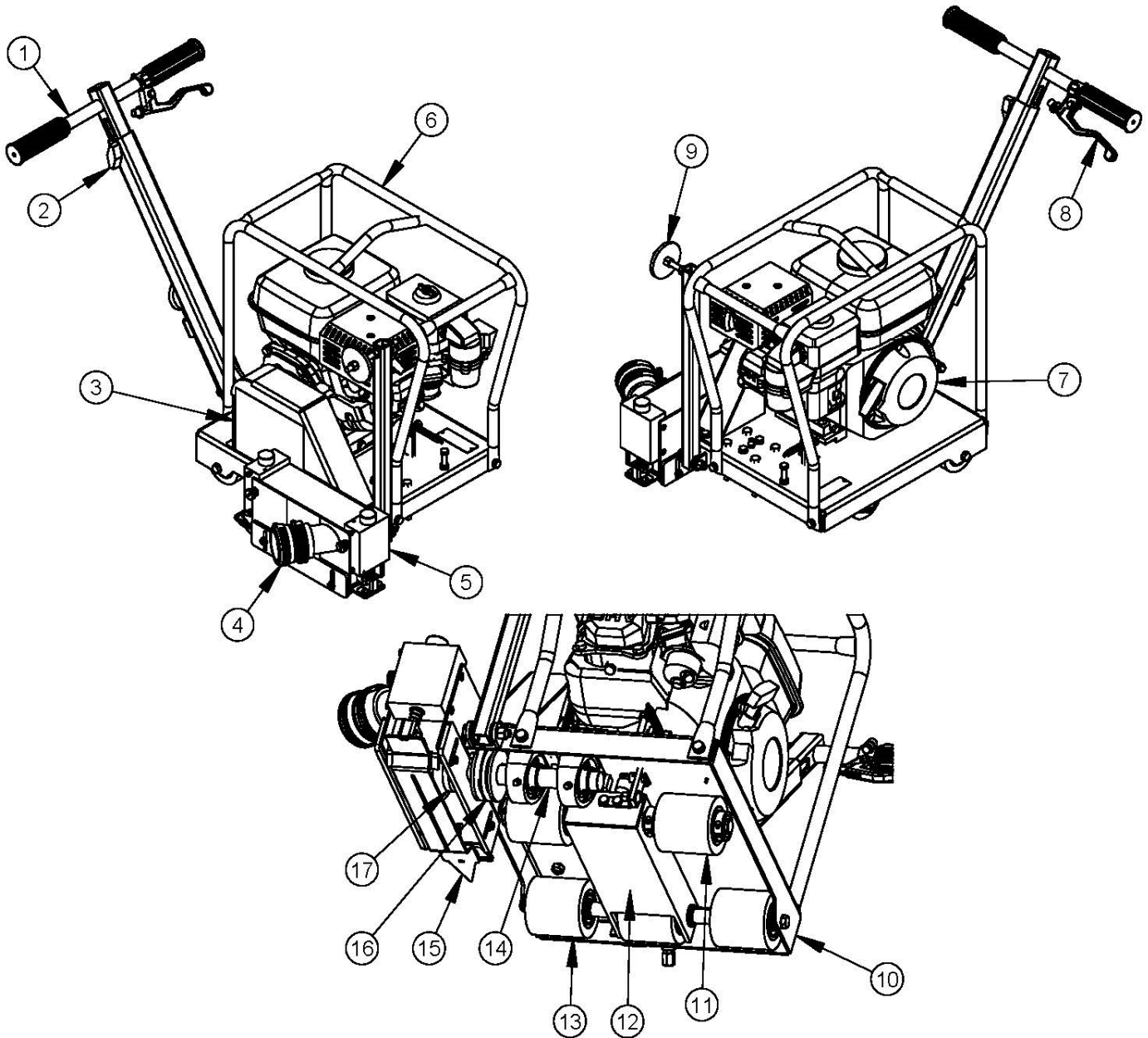

1. Handlebar
2. Handlebar Locking Knobs
3. Belt Guard
4. Vacuum Hose Attachment
5. Spring Box
6. Lift Cage
7. Engine
8. Handlebar Lever
9. Front Pointer

10. Frame Base
11. Front Wheels
12. Front Axle
13. Rear Wheels
14. Blade Shaft
15. Spring Loaded Skid Plate
16. Belt Drive
17. Blade Flan

INTRODUCTION

CC150XL-EE6 Series Dimensions

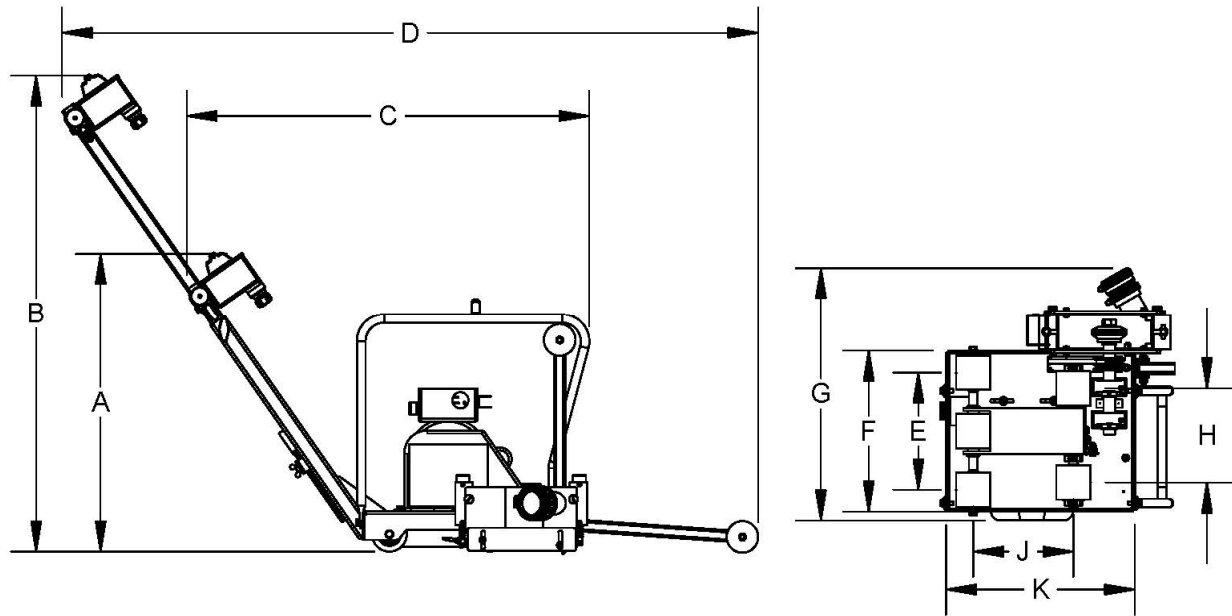

CC125BXL-EE6 Dimensions		Inches	Millimeters
A	Saw Height – Min. (Handlebars down)	24	610
B	Saw Height Max. – (Handlebars up) (Electric)	38	965
	Saw Height Max. – (Handlebars up) (Gas)	40	1016
C	Saw Length - Min. (Handlebars down, Pointer up)	34	864
D	Saw Length - Max. (Handlebars up, Pointer down)	61	1549
E	Rear Axle Center Length	10	254
F	Frame Width	14	356
G	Saw Width	21	533
H	Front Axle Center Length	9	229
J	Wheel Base Length	8-1/2	216
K	Frame Length	16-1/2	419

INTRODUCTION

CC150XL-EE6 Series Specifications

Saw Model	CC125BXL	CC148HXL	CC165BVXL	CC165LXL
Blade Capacity	6"			
Blade Cutting Depth Max	1-3/16"			
Blade Shaft Speed¹	4200 rpm	4385 rpm		
Blade Flange Size	3"			
Lubrication Type	NLGI #1 lithium synthetic grease			
Blade Arbor Size	1" Diameter			
Blade Shaft Size	1" Diameter			
Blade Shaft Bearings	2 self-aligning pillow block bearings			
Blade Shaft Drive	(1) V-Belt 3VX280	(1) V-Belt 3VX300		
Spring Box Attachment	(2) 5/16"-18 hex head cap screws			
Blade Raise and Lower	Mechanical with spring loaded release			
Blade Alignment	Telescoping front pointer			
Axle Size (Front/Rear)	3/4" OD straight			
Front Wheels	(2) 3" x 3" x 3/4" (sealed ball bearings)			
Rear Wheels	(3) 3" x 3" x 3/4" (sealed ball bearings)			
Handle Bar Adjustment	Variable extension with 19" range			

1. Theoretical speed. Actual speeds will vary.

INTRODUCTION

CC150XL-EE6 Electric Motor Specifications

Saw Model	CC125BXL
Motor Model	Baldor 35U599X459G1
Rated Output Power	2.5 HP
Rated Speed	3450 rpm (Baldor rating)
Rated Voltage	115/230 V
Full Load Amps	21/10.5 A
Rated Frequency	60 Hz.
Phase	1

CC150XL-EE6 Gas Engine Specifications

Saw Model	CC148HXL	CC165BVXL	CC165LXL
Engine Model	Honda (GX160)	Vanguard (13L3)	Lifan (LF168F2)
Rated Output Power	4.8 HP @3600 rpm	6.5 HP @ 3600 rpm	
Fuel Type	Gas (87 Octane)		
Fuel Tank	.82 Gal. (3.1 Liters)	1.1 Gal. (4.1 Liters)	1.0 Gal. (3.8 Liters)
Engine Oil	SAE 10W-30		
Engine Oil Capacity	.61 Qt. (.58 Liters)	.69 Qt. (.65 Liters)	.63 Qt. (.6 Liters)
Spark Plug Gap	028 – 031 in (.70 - .80 mm)	.030 in (.76 mm)	028 – 031 in (.70 - .80 mm)
Safety Alert	Low oil level shutdown		

SAFETY PRECAUTIONS

Safety

Operate the equipment and all of its components according to this manual. Failure to comply with and understand the following safety, operation and maintenance instructions can result in serious injuries and/or death. All operators must be properly trained or supervised by experienced personnel prior to using this saw and should understand the risks and hazards involved. Diamond Products discourages improper or unintended equipment usage and cannot be held liable for any resulting damages.

Equipment modifications should be made by Diamond Products to ensure safety and design. Any modifications made by the owner(s) are not the responsibility of Diamond Products and void all equipment warranties if a problem arises as a result of the modification.

Refer to the Diamond Products Parts List for additional information and part diagrams. Refer to the motor manufacturer as the primary source for all safety, operations, and maintenance instructions regarding the motor. Prior to operating, record the saw's serial number, and the motor's model and serial numbers in Appendix D.

Notice: The information in this manual may be updated at any time!

Safety Alerts



DANGER

Serious injuries and/or death will occur if these instructions are not followed.



WARNING

Serious injuries and/or death could occur if these instructions are not followed.



CAUTION

Mild and/or moderate injuries could occur if these instructions are not followed.

Proposition 65

PROPOSITION 65



WARNING: Concrete cutting produces dust that can expose you to chemicals including Silica, crystalline (airborne particles of respirable size), which is known to the state of California to cause cancer. For more information go to:

WWW.P65WARNINGS.CA.GOV

Respiratory Hazards



WARNING

Concrete cutting produces dust and fumes known to cause illness, death, respiratory disease, birth defects, and/or other reproductive harm. Safety protection techniques include, but are not limited to:

- Wearing gloves.
- Wearing safety goggles or a face shield.
- Using approved respirators.
- Washing work clothes daily.
- Using water when wet cutting to minimize dust.
- Washing the hands and face prior to eating/drinking.

For additional safety and self-protection information contact your employer, the Occupational Safety and Health Administration (OSHA), and/or The National Institute for Occupational Safety and Health (NIOSH).

SAFETY PRECAUTIONS

General Safety

- Read and understand all safety, operations, and maintenance instructions provided in this manual prior to operating or servicing the saw.
- Keep equipment components clean and free of slurry, concrete dust, and debris.
- Inspect water hoses prior to operating the equipment. Clean, repair, or replace damaged components.
- Raise the equipment to a proper height for access when working underneath the equipment. Use chocks to block the wheels, and fit blocks or jacks under the frame edges.
- When using a jack to raise the equipment, place the jack against a solid, flat area under the frame base to properly support the equipment.
- Repair the equipment immediately when a problem arises.
- Replace equipment decals if unreadable.
- Dispose of all hazardous waste materials according to city, state, and federal regulations.
- Always have a phone nearby, and locate the nearest fire extinguisher and first aid kit prior to operating the equipment.
- Operate the equipment wearing flame resistant clothing.
- Always wear safety glasses when removing retaining rings.
- Underage or non-trained personnel should not operate the equipment.
- Keep all body parts away from rotating machinery.
- Replace all guards and access panels (unless stated otherwise) prior to operating the equipment.

DO NOT:

- Assume the equipment will remain still when parking/stopping the equipment on a slope. Chock the wheels to help prevent unnecessary movement.
- Drop equipment, supplies, tools, etc., when handling to help prevent injuries.
- Lift and carry equipment, supplies, tools, etc., that are too heavy and/or cannot be lifted easily.

- Operate the equipment without using the appropriate safety equipment required for the work task.



- Operate or service the equipment with any clothing, hair, or accessories that can snag in the machinery, which could lead to serious injuries or death!
- Operate the equipment using attachments not associated with or recommended for the equipment.
- Operate the equipment around combustible materials.
- Operate the equipment with anyone near the work area or within the direct line of the blade.
- Operate the equipment until all unnecessary materials have been removed from the work area.
- Operate the equipment with loose nuts, screws, and bolts.
- Operate the equipment when ill or fatigued.
- Operate the equipment under the influence of drugs and/or alcohol.
- Operate the equipment on steep slopes.
- Cut concrete with guards and access panels removed.
- Grease the equipment with the engine/motor running.
- Touch hot components when operating the equipment.
- Leave the equipment unattended until the engine/motor is off and the blade has stopped.
- Place the equipment into storage until it has cooled down.
- Service the equipment until it has cooled down.
- Service the equipment with the engine/motor running.

Blade Safety

- Always use reinforced abrasive blades or steel-centered diamond blades.
- Inspect all blades prior to usage and discard damaged blades.
- DO NOT install or remove a blade with the engine/motor running.
- Keep all body parts away from rotating blades.

SAFETY PRECAUTIONS

- Inspect the blade flanges for damages, wear, and cleanliness. Clean or replace dirty/damaged components immediately.

- DO NOT expose yourself or anyone else to the direct line of the blade when operating the equipment.



- Always use an appropriate size blade and the correct blade type based on the cutting task and the type of material being cut.
- The blade must always fit snug on the blade shaft, outer flange, and/or inner flange.
- Wear gloves and be alert to the surrounding environment when handling blades.
- When installing the blade, always point the arrow printed on the blade in the direction of the blade shaft's rotation.
- DO NOT exceed the blade's maximum recommended speed when cutting. Excessive blade speeds can cause blade breakage, resulting in serious injuries and/or death!
- DO NOT use damaged blades when cutting to avoid harming yourself, others, or the equipment.
- DO NOT use a blade for cutting that requires a lower speed than the blade shaft speed.
- Always tighten the blade shaft flange nut as directed to properly secure the outer flange and blade. Failure to properly secure the outer flange and blade may cause parts to loosen or fall off the equipment, resulting in serious injuries or death!
- Let the blade cool prior to removal.
- Inspect the skid plate for damage, wear, and cleanliness. Clean or replace dirty/damaged components immediately.

Spring Box Safety

- DO NOT operate the equipment with the spring box removed.
- Blade exposure should not exceed 180° while cutting.
- DO NOT install or remove the spring box with the engine or motor running.

Fuel Safety

- Always use caution when refueling.
- Store all fuel in appropriate safety containers.
- DO NOT operate the saw with a fuel leak.
- DO NOT fuel the saw with the engine running.
- Let the engine cool prior to adding fuel.
- Refer to the engine manual for recommended fuels.
- Always use appropriate fuels in cold weather.
- Move the saw away from the refueling area prior to starting the engine.
- DO NOT smoke or expose fuel to open flames when filling the fuel tank or working with fuel.
- Clean up any spilled fuel prior to starting the engine.
- Drain the fuel tank and fuel lines when storing the saw for longer periods of time. Refer to the engine manual for additional recommendations.
- Fuel may seep out from the fuel cap vent (applicable models) when raising the saw if the fuel tank has been overfilled.





Engine/Motor Safety

- Refer to the engine/motor manual as the primary source for engine/motor safety.
- Always know how to turn off the engine/motor quickly for emergency purposes.
- Make sure the speed control lever (applicable models) is at *Neutral* when starting the engine/motor.
- Fill the fuel tank and check the oil level prior to starting the engine.
- Keep all body parts away from rotating saw parts with the engine/motor running.
- DO NOT start the engine without the air filter(s) installed.
- DO NOT allow dust to enter the air intake tube when cleaning/replacing air filter(s).
- Replace damaged components immediately that may allow dust to enter the engine.
- DO NOT leave the engine/motor running unattended.



SAFETY PRECAUTIONS

- Always operate the saw in well-ventilated areas. Concentrated engine exhaust can cause loss of consciousness and/or death. 
- DO NOT touch the engine/muffler assembly with the engine running, and always let them cool down prior to touching or servicing the saw.
- Handle hot oil carefully when changing the oil.
- Wipe down the engine/motor exterior and guards daily or regularly to prevent high operating temperatures. DO NOT spray the engine/motor with water to prevent engine/motor damage.
- Let the engine cool prior to removing pressurized caps (applicable models). 
- All electric motor saws should be properly grounded prior to operating.
- DO NOT supply less or more power to the electric motor saw than what the motor is rated for.

Cutting Safety

- The direct work area should not contain buried or embedded electrical, gas, or water lines that could be damaged and/or cause personal injury while cutting.
- Turn off all electricity, gas, and water around the direct work area prior to cutting.
- Inspect the work area to ensure nothing will impede full control of the machine at all times.
- DO NOT expose yourself or anyone else to the direct line of the blade when operating the equipment.
- DO NOT allow any person, animal, and/or objects in and around the work area while cutting.
- DO NOT install a blade on the machine until it is in the cutting area.
- Ensure the work area is adequately illuminated to ensure safe operation of the machine.

Belt Safety

- Turn off the engine/motor and let the belt cool down prior to servicing it.
- Regularly inspect the belt for fraying, stress cracks, and/or breakage and replace immediately when damaged. Always check the belt alignment prior to operating the equipment.
- Use extreme caution when working with belts and rotating machine parts to avoid entanglement.
- Over-tensioning the belt may reduce the life of the blade shaft bearings. Under-tensioning the belt may cause slippage, shorter belt life, and/or poor equipment performance.
- Squealing belts indicate looseness.

Transporting Safety

- Remove the blade prior to transporting the equipment.
- Chock the wheels and secure the saw in the truck/trailer prior to transporting.
- Refer to the Department of Transportation (DOT) for additional transportation recommendations.

Lifting Safety

- Move yourself and all others away from the lifting area when hoisting the saw to prevent being crushed. 

- Secure the appropriate hoisting cables, straps, and/or chains to the saw's designated lift points prior to hoisting.
- DO NOT attempt to lift the saw irresponsibly and/or improperly.

Operating

General Operating Precautions

- Prior to operating the machine, read the operator's manual thoroughly and ensure that you understand the safe and proper operation of the machine.
- Use approved personal protective equipment at all times while operating the machine.
- Ensure that there is firefighting equipment and a first aid kit nearby while operating the machine.
- Ensure the cutting area is free of obstructions, people, and or animals prior to operating the machine.
- Always operate the machine from the operator's position at the rear of the machine.
- Do not stand in front or behind the blade path while the motor is running.

Handlebars

The handlebars help the operator guide and maneuver the saw.

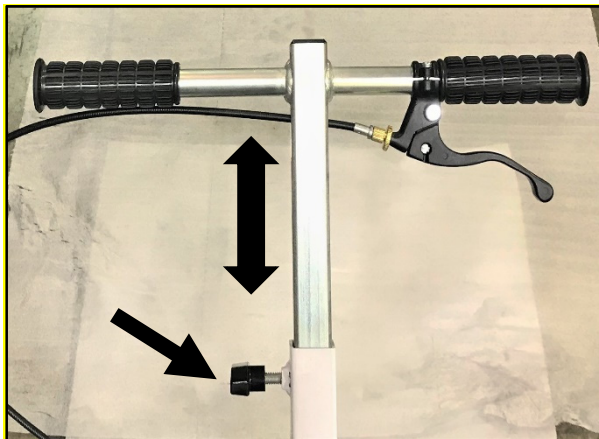

Handlebars

Adjusting the Handlebars

1. Loosen the handlebar lock knob.
2. Adjust the handle bars to the desired height by pulling out or pushing in on the handlebar grips.
3. Retighten the handlebar lock knob to secure.
4. Adjust the handlebar height as necessary.

Front Pointer

The front pointer helps the operator follow the cutting line.

Adjusting the Front Pointer

1. Raise the saw.
2. Remove the vacuum attachment plate from the spring box by turning the two thumbscrews counter clockwise.

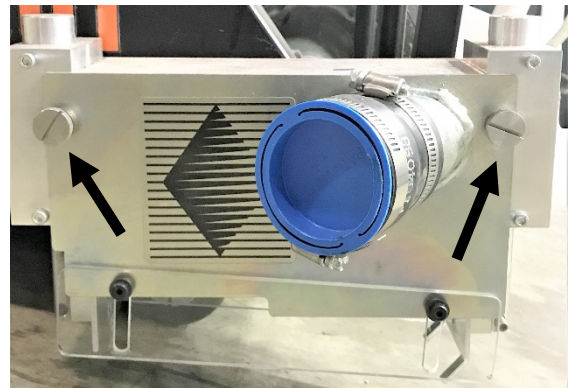

Vacuum Attachment Plate Thumbscrews

3. Remove the skid plate weldment from the bottom of the spring box by removing the retaining pin located at the rear of the skid plate.

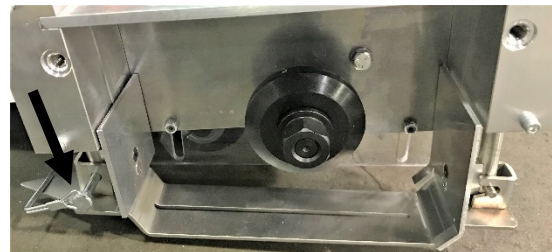

Skid Plate Retaining Pin

4. Lower the front pointer to the ground.
5. Divide a 4 - 5 ft. piece of string in half.
6. Place the looped end of string into a gullet on the backside of the blade.
7. Place one string line up against the backside of the blade and one string line up against the front side of the blade. Holding the string ends in one hand, tension the lines out toward the pointer wheel.



String Line and Blade

8. Adjust the hex nuts and guide wheel to place the wheel between the tensioned string lines.

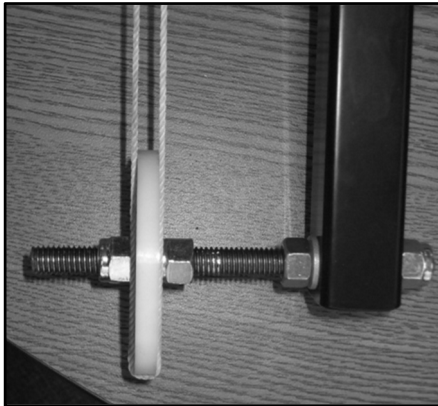

Guide Wheel

9. Raise the front pointer back to the up position.
10. Remove the string.
11. Replace the skid plate weldment and reinsert the pin to secure.
12. Replace the vacuum attachment plate and tighten the thumbscrews to secure.

Diamond Blades

⚠️ WARNING

- DO NOT exceed the blade's maximum recommended speed when cutting. Excessive blade speeds can cause blade breakage, resulting in serious injuries and/or death!
- DO NOT use damaged blades when cutting to avoid harming yourself, others, or the saw.
- Always use an appropriate size blade and the correct blade type based on the cutting task and the type of material being cut.



Using the proper blade (size and type) preserves the blade and improves cutting and operator efficiency, resulting in lower costs. Refer to the Association of Equipment Manufacturers (AEM) safety brochure for diamond blades or www.diamondproducts.com for additional blade information.

Inspecting the Blade

Inspect each blade prior to installation and discard all damaged blades. Inspect all blades for:

- Cracks, nicks, and dents
- A damaged and/or deformed arbor (center hole)
- Darkness and/or discoloration near the edge of the blade
- A deformed blade circumference
- Segment loss and/or segment cracks
- Core wear
- Bending
- Uneven side-widths

Blade Speed

Refer to the blade packaging information or to the information printed on the blade for the maximum recommended blade speeds when cutting. DO NOT exceed the maximum recommended speed while cutting. DO NOT use a blade that is rated with a lower maximum operating speed than the blade shaft speed.

Installing the Blade

⚠️ WARNING

- DO NOT install a blade with the engine/motor running. Failure to properly secure the outer flange and blade may cause parts to loosen or fall off the saw.



⚠️ CAUTION

- Wear gloves and be alert to the surrounding environment when handling blades.

1. Raise the saw.
2. Remove the vacuum attachment plate from the spring box by turning the two thumbscrews counter clockwise.

OPERATING

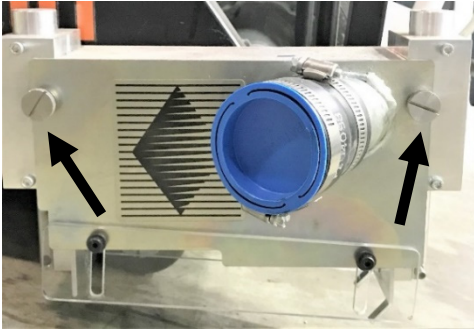

Vacuum Attachment Plate Thumbscrews

3. Press the anti-rotation pin down, located on the front frame base, while spinning the blade shaft by hand until the pin engages the slot in the shaft preventing it from rotating.



Anti-Rotation Pin

4. While holding the anti-rotation pin down, remove the blade shaft nut by turning it counterclockwise to loosen.
5. Carefully pull the outer flange off of the blade shaft.



Removing the Outer Flange

6. Inspect the nut, outer flange, and inner flange for damages and clean, repair, or replace as necessary.

7. Inspect the blade for damages. DO NOT use blades that are too large or too small for the saw.
8. Fit the blade onto the blade shaft and place it against the inner blade flange (the blade should fit snug on the blade shaft). Always point the arrow printed on the blade in the direction of the blade shaft's rotation.
9. Fit the outer flange onto the blade shaft and place it against the blade.



Inserting the Outer Flange

10. Place the blade shaft nut onto the end of the blade shaft and tighten the nut by hand.
11. Press the anti-rotation pin down, located on the front frame base, while spinning the blade shaft by hand until the pin engages the slot in the shaft preventing it from rotating.



Tightening the Nut

12. While holding the anti-rotation pin down, tighten the nut to 50 ft-lb (67.8 Nm) to properly secure the outer flange and blade. This measurement can be verified with a torque wrench.
13. Raise the saw off the ground and replace the skid plate weldment and reinsert the pin to secure.
14. Replace the vacuum attachment plate and tighten the thumbscrews to secure.

OPERATING

15. Check to ensure the skid plate is properly centered by lifting the front and rear spring box pistons up and down.

Removing the Blade



- DO NOT remove a blade with the engine/motor running.

1. Raise the saw.
2. Remove the vacuum attachment plate from the spring box by turning the two thumbscrews counter clockwise.

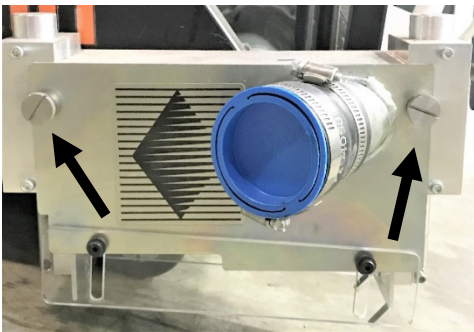

Vacuum Attachment Plate Thumbscrews

3. Press the anti-rotation pin down, located on the front frame base, while spinning the blade shaft by hand until the pin engages the slot in the shaft preventing it from rotating.

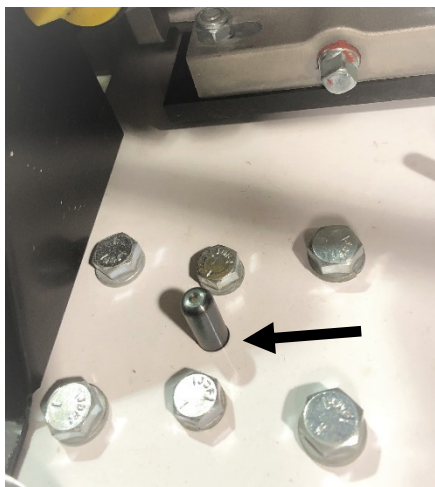

Anti-Rotation Pin

4. Remove the blade shaft nut.
5. Carefully remove the outer flange from the blade shaft, and then remove the blade. Place the blade in an appropriate storage location.

6. Inspect the nut, outer flange, and inner flange for damages and clean, repair, or replace as necessary.
7. Fit the outer flange onto the blade shaft, against the inner flange.
8. Fit the blade shaft nut onto the blade shaft and tighten the nut by hand to secure the flanges together.
9. Replace the vacuum attachment plate and tighten the thumbscrews to secure.

Raising and Lowering the Saw/Blade

Raising the Saw

1. Ensure the handlebars are locked at a comfortable height.
2. Push down on the handlebars to pivot the saw on the rear wheels, this will raise the saw and lock in position.

Lowering the Saw/Blade

1. Ensure the handlebars are locked at a comfortable height.
2. Squeeze the handlebar lever and push up on the handlebars to unlock and lower the saw.

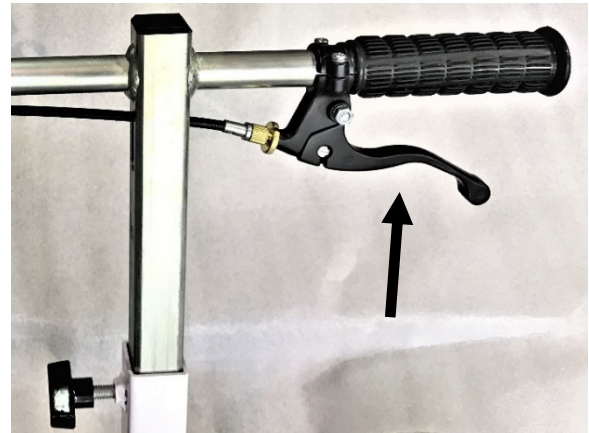

Handlebar Lever

Spring Box Assembly

The spring box assembly is a multi-functional component of the saw. It acts as the blade guard, provides a connection port for a dust collection vacuum, and houses the skid plate. The skid plate is spring loaded to keep it down on the cutting surface to prevent spalling.

It is imperative to keep the skid plate in good condition, free from burrs, cracks or sharp edges that may cause damage to the cutting surface. Inspect the skid plate daily and repair or replace if any damage is present or whenever a new blade is installed.

Motor

The CC125BXL-EE6 saw uses a 2-1/2 HP, 115/230 V, single phase Baldor electric motor rated at 3450 RPM.

Prior to Starting the Motor

The 2-1/2 power Baldor motor can be operated in either 115 volt or 230 volt setup. Complete the following steps to choose the required voltage:

1. Locate the voltage selector switch on the side of the motor.
2. Remove the locking bolt from the selector switch mount.
3. Toggle the switch to the required voltage.
4. Re-install the locking bolt into the selector switch mount and tighten the nut to secure.

The motor is controlled through a switch box. The switch box assembly allows the operator to start and stop the motor.



WARNING

DO NOT leave the saw unattended while the motor is running.

Starting the Motor

1. Ensure the saw is in the raised position.
2. Connect the saw to a power source using a properly sized power cord in accordance with Appendix B.



CAUTION

Use of a wire gauge that is too small will cause loss of power or overheating and will damage the electric motor

3. Move the starter switch to the ON position
4. Allow the motor to come up to full operating speed.

Stopping the Motor



CAUTION

DO NOT leave the saw unattended until the motor is off and the blade has stopped spinning.

1. Ensure the saw is in the raised position.
2. Move the starter switch to the OFF position.
3. Disconnect the motor from the power source

Engines

There are three gas engines used with the CC150XL-EE6 series:

The CC148HXL-EE6 saw uses a 4.8 HP Honda gas engine rated at 3600 RPM.

The CC165BVXL-EE6 uses a 6.5 HP Vanguard gas engine rated at 3600 RPM.

The CC165LXL-EE6 saw uses a 6.5 HP Lifan gas engine rated at 3600 RPM.

NOTE: All of the gas engines are equipped with an oil alert system. If the oil level is below the lower limit, the engine will not start.

Starting the Honda engine

Refer to the manufacturer's engine manual as the primary source of information regarding the engine.



WARNING

- DO NOT leave the saw unattended while the engine is running.
- Always operate the saw in a well ventilated area. Concentrated exhaust can cause loss of consciousness and/or death.

1. Move the fuel valve lever to the ON position.
2. Move the choke lever to the CLOSED position.

OPERATING

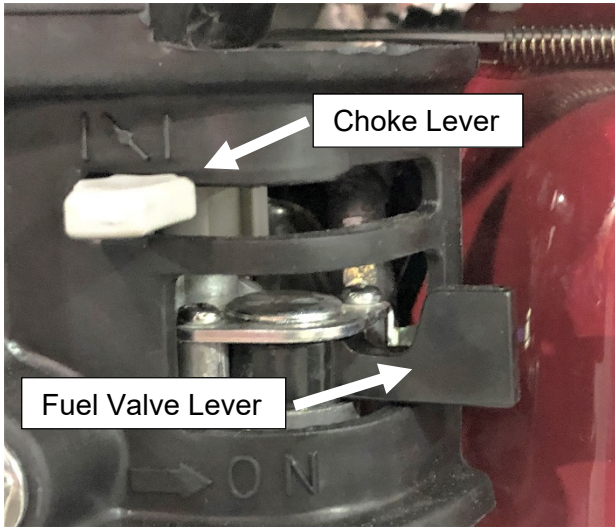

Fuel Valve Lever and Choke Lever

NOTE: To restart a warm engine, leave the choke lever in the OPEN position.

3. Move the throttle lever away from the Min. position, about 1/3 of the way toward the MAX. position.

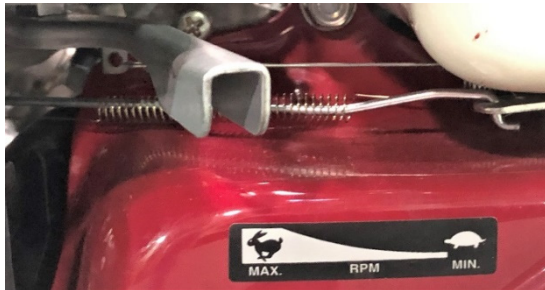

Throttle Lever

4. Turn the engine switch to the ON position.



Engine Switch

5. Pull the starter grip lightly until resistance is felt, then pull briskly on the grip away from the engine.
6. Return the starter grip gently to prevent damage to the starter.

7. IF THE ENGINE STARTS, slowly move the choke lever to the OPEN position as the engine warms up.
8. Move the throttle lever to the MAX. position.
9. IF THE ENGINE DOES NOT START, move the choke lever to the OPEN position and move the throttle lever to the MAX. position. Repeat steps 5 & 6 until the engine starts.

Stopping the Honda Engine

CAUTION

DO NOT leave the saw unattended until the engine is off and the blade has stopped spinning.

NOTE: to stop the engine in an emergency, turn the engine switch to the OFF position. Under normal conditions, use the following procedure:

1. Move the throttle lever to the MIN. position.
2. Turn the engine switch to the OFF position.
3. Move the fuel valve lever to the OFF position.

Starting the Vanguard Engine

Refer to the manufacturer's engine manual as the primary source of information regarding the engine.

WARNING

- DO NOT leave the saw unattended while the engine is running.
- Always operate the saw in a well ventilated area. Concentrated exhaust can cause loss of consciousness and/or death.

1. Move the fuel valve lever to the ON position.
2. Move the choke lever to the CLOSED position.

OPERATING

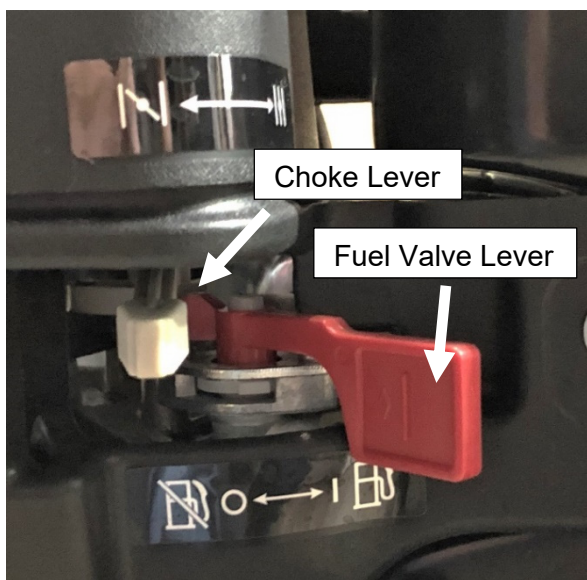

Fuel Valve Lever and Choke Lever

NOTE: To restart a warm engine, leave the choke lever in the OPEN position.

3. Move the throttle lever to the full right, FAST position.

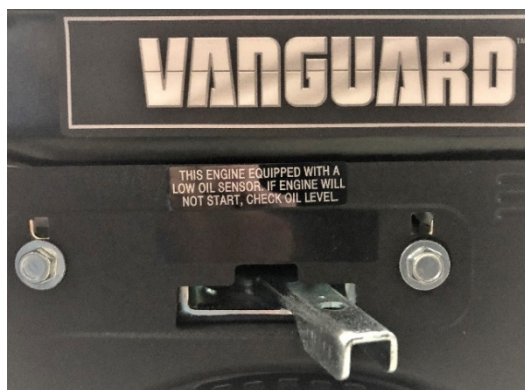

Throttle Lever

4. Pull the starter grip lightly until resistance is felt, then pull briskly on the grip away from the engine.
5. Return the starter grip gently to prevent damage to the starter.
6. IF THE ENGINE STARTS, slowly move the choke lever to the OPEN position as the engine warms up.
7. IF THE ENGINE DOES NOT START, move the choke lever to the OPEN position. Repeat steps 4 & 5 until the engine starts.

Stopping the Vanguard Engine



DO NOT leave the saw unattended until the engine is off and the blade has stopped spinning.

NOTE: Do not choke the carburetor to stop the engine.

1. Move the fuel valve lever to the OFF position.
2. When the engine stops running, move the choke to the CLOSED position.

Starting the Lifan Engine

Refer to the manufacturer's engine manual as the primary source of information regarding the engine.



- DO NOT leave the saw unattended while the engine is running.
- Always operate the saw in a well ventilated area. Concentrated exhaust can cause loss of consciousness and/or death.

1. Move the fuel valve lever to the ON position.
2. Move the choke lever to the CLOSED position.

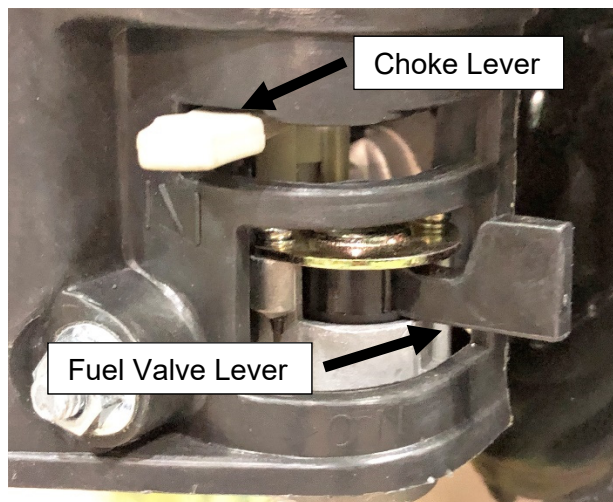

Fuel Valve Lever and Choke Lever

NOTE: To restart a warm engine, leave the choke lever in the OPEN position.

OPERATING

3. Move the throttle lever away from the Min. position, about 1/3 of the way toward the MAX. position.

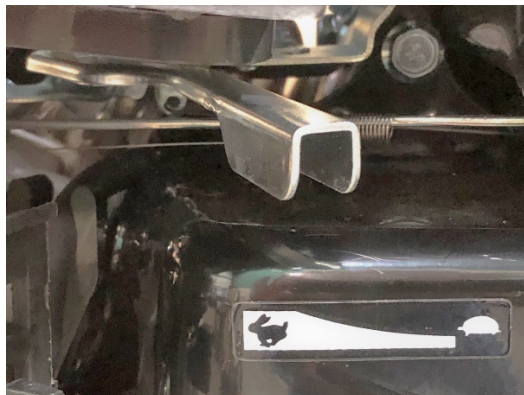

Throttle Lever

4. Turn the engine switch to the ON position.

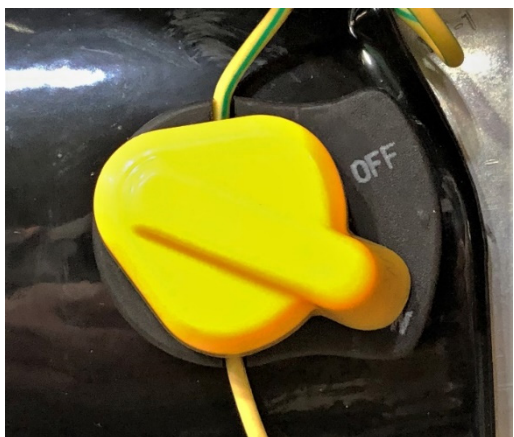

Engine Switch

5. Pull the starter grip lightly until resistance is felt, then pull briskly on the grip away from the engine.
6. Return the starter grip gently to prevent damage to the starter.
7. IF THE ENGINE STARTS, slowly move the choke lever to the OPEN position as the engine warms up.
8. Move the throttle lever to the MAX. position.
9. IF THE ENGINE DOES NOT START, move the choke lever to the OPEN position and move the throttle lever to the MAX. position. Repeat steps 5 & 6 until the engine starts.

Stopping the Lifan Engine



CAUTION

DO NOT leave the saw unattended until the engine is off and the blade has stopped spinning.

NOTE: to stop the engine in an emergency, turn the engine switch to the OFF position. Under normal conditions, use the following procedure:

1. Move the throttle lever to the MIN. position.
2. Turn the engine switch to the OFF position.
3. Move the fuel valve lever to the OFF position.

Fueling the saw

For the gas powered saws, fill the tank as needed.

1. Lower the saw so that the engine is level.
2. Stop the engine and let the saw cool down.
3. Remove the fuel tank cap.
4. Fill the tank with unleaded gasoline (87 Octane).
5. Replace the fuel tank cap and tighten to secure.

Cutting

Cutting Guides

Use the front pointer as needed to help follow the cutting line. Always check the front pointer for proper alignment with the blade prior to cutting.

Straight Line Cutting



WARNING

DO NOT expose yourself or anyone else to the direct line of the blade when operating the saw.

The direct work area should not contain buried or embedded electrical, gas, or water lines that could be damaged and/or cause personal injury while cutting.



NOTE: Always raise the blade to provide proper clearance between the blade and the pavement when maneuvering the saw.

Helpful Hints Prior to Cutting

Keep the following in mind for better efficiency while cutting:

- Use just enough handle pressure to guide the saw down the cutting line. DO NOT forcibly direct (twist) the saw from side to side when cutting. DO NOT jam, cock, or wedge the blade in a cut.

- DO NOT lower the blade too quickly or move the saw forward too quickly when finishing a partial-cut to avoid forcing the blade into the concrete.
- Refer to the Diamond Products' Guide for Professional Concrete Cutters for additional cutting tips and information.

Tasks Prior to Cutting

Complete the following tasks prior to cutting:

- Ensure the blade size is correct for the belt drive configuration.
- Check the skid plate for any burrs or nicks that may damage the concrete and correct as necessary.
- Align the cutting guide(s) with the blade.
- Clearly mark the cutting line.
- Turn off all electricity, gas, and water around the direct work area.

Making a Cut

1. Align the blade and front pointer with the cut line.
2. Start the saw in accordance with the operations called out in this manual and let the blade come up to speed.
3. Slowly lower the blade into the cutting surface until the skid plate is securely on **the** cutting surface to prevent spalling.
4. Push the saw forward, at a proper speed, to continue down the cutting line. Cut as fast as the blade allows for maximum efficiency. If the blade climbs out of the cut, reduce the forward speed.

NOTE: Always be aware of the cutting line, as concrete debris may make it harder to see.

Continuing a Partial-Cut

1. Align the blade with the previous cut.
2. Lower the blade back into the cut. DO NOT move forward unless the blade is properly aligned within the cut.
3. Push the saw forward, at a proper speed, to continue down the cutting line. Cut as fast as the blade allows for maximum efficiency. If the blade climbs out of the cut, reduce the forward speed.

Finishing a Cut

1. Stop the saw.
2. Raise the blade from the cut.

Maintenance

General

Failure to read and comply with the maintenance instructions provided in this manual prior to performing maintenance may result in serious injuries and/or death, and may harm the saw. DO NOT attempt to perform maintenance on the saw if you are not properly trained for it, or are not supervised by an experienced person.

Refer to the CC150XL-EE Parts List for additional information and part diagrams when performing maintenance tasks. Refer to the motor manufacturer as the primary source for all safety, operations, and maintenance instructions for the motor. Contact the saw and/or motor manufacturer with any additional questions.

Remove all necessary guards and access panels prior to servicing the saw. Replace prior to operating.

Pre Maintenance Preparations

- Ensure the saw is in a safe area to conduct maintenance.
- Maintain proper cleanliness of the work area to minimize personnel injury or equipment damage.
- Ensure the saw is sufficiently cool to conduct any maintenance.
- Remove the cutting blade prior to starting any maintenance.
- Place the saw on a level surface with the motor turned off.
- Ensure there is adequate lighting in the work area to ensure safety.
- Ensure all equipment and tools required for the maintenance task are staged and available for use.

- Prior to any maintenance being performed, know the locations of all safety equipment such as fire extinguishers, first aid kits, etc.
- All maintenance shall be performed by qualified personnel only.

General Cleaning

The saw must be cleaned after each use and prior to conducting any maintenance. Ensure that the saw is cool prior to cleaning. Ensure affected electrical equipment is properly covered or de-energized prior to cleaning with water or air.

Cleaning Techniques

Various cleaning options can be utilized depending on the type of cleaning required. High pressure washers and a mild detergent will work the best. Compressed air and low pressure water can also be utilized where required.



CAUTION

Care must be taken when using high pressure water and compressed air to conduct any maintenance or cleaning. High pressure water and compressed air can cause injury to personnel or damage to equipment if not used properly.

Starter Switch Control Box

Do not spray water on the starter switch control box to clean. Use a damp cloth or compressed air to clean electrical components. Dry the starter box panel after cleaning.

Motor

Use a mild detergent and water to clean the motor. Do not to spray water forcefully on the motor to prevent damage to components.

Part Lubrication



Lubricate all necessary parts on schedule for maximum saw efficiency. Occasionally lubricate controls, cables, hinges, latches, and linkages with a spray lubricant when movement becomes stiff and/or sluggish. Use one half to one full pump of NLGI No. 1 premium, lithium-based grease when lubricating all grease fittings.

Post Cleaning

- Lubricate the machine as required.
- Dry all electrical components using compressed air.
- Do not start the machine until it has had time to thoroughly dry.

MAINTENANCE

Service Schedule

The service schedule is based primarily on the standard operating time of the machine. The frequency of the maintenance tasks can be increased based on the working environments of the machine. Refer to the individual manufacturers manuals for additional maintenance requirements.

Task	Cycle		
	Daily	100 Hrs.	Yearly
Visually inspect saw for damage and repair as necessary	X		
Wipe down and clean all components for dust, debris, and slurry	X		
Check that all safety guards are in place and in good operating condition	X		
Inspect the skid plate for damages and clean, repair, or replace as necessary.	X		
Check for loose or frayed wiring. Repair/replace as necessary	X		
Check for loose nuts and bolts and retighten	X		
Check engine oil level	X		
Check fuel level	X		
Check air filter	X		
Lubricate blade shaft bearings (End of work day)	X		
Inspect all belts for tension or wear and re-tension or replace as necessary	X ¹		
Clean air filter		X ²⁻³	
Replace engine oil		X ⁴	
Clean sediment cup		X	
Check and adjust spark plug		X	
Clean spark arrester		X ⁵	
Replace air filter			X
Replace spark plug			X

1 - Initially inspect the belt after the first four hours and then daily.

2 - Change every 25 hours on Vanguard engine.

3 - Service more often as required

4 - Replace every 50 hours in Vanguard engine

5 - Clean every 50 hour on Vanguard engine

Daily Service

Handlebars

The handlebars generally require little or no maintenance and, when used correctly, should remain in good, working condition. Inspect the handlebars occasionally for bending, unusual cracks, and/or breakage. Replace them immediately when damaged.

Skid Plate

The skid plate prevents spalling while cutting. Inspect the cutting slot and the concrete side of the plate daily for damage or excessive wear. Clean or replace as necessary.

Replacing the Skid Plate

1. Raise the saw.
2. Remove the vacuum attachment plate from the spring box by turning the two thumbscrews counter clockwise.

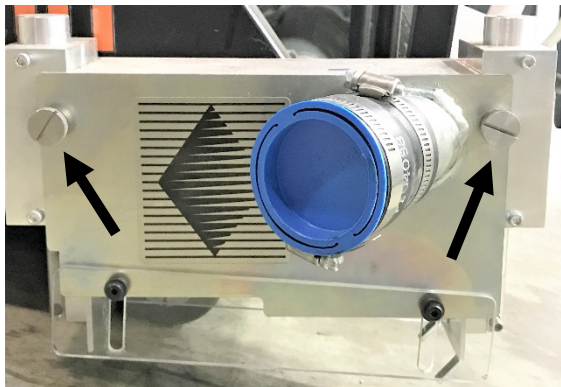

Vacuum Attachment Plate Thumbscrews

3. Remove the skid plate weldment from the bottom of the spring box by removing the retaining pin located at the rear of the skid plate.



Skid Plate Retaining Pin

4. Install a new skid plate and reinsert the retaining pin to secure.
5. Reinstall the vacuum attachment plate to the spring box using the two thumbscrews.

Lubricate the Blade Shaft Bearings



WARNING



DO NOT grease parts with the motor running.

Lubricating the blade shaft bearings on schedule increases the saw's efficiency and life. Use NLGI No. 1 premium lithium-based grease when lubricating parts. Use one-half to one full pump of grease when lubricating grease fittings.

At the end of each work day, lubricate the two front blade shaft bearings. Locate the right and left blade shaft bearing grease fittings located under frame base at the front of the saw.

1. Add no more than one pump of bearing grease into each of the two blade shaft bearing grease fittings.

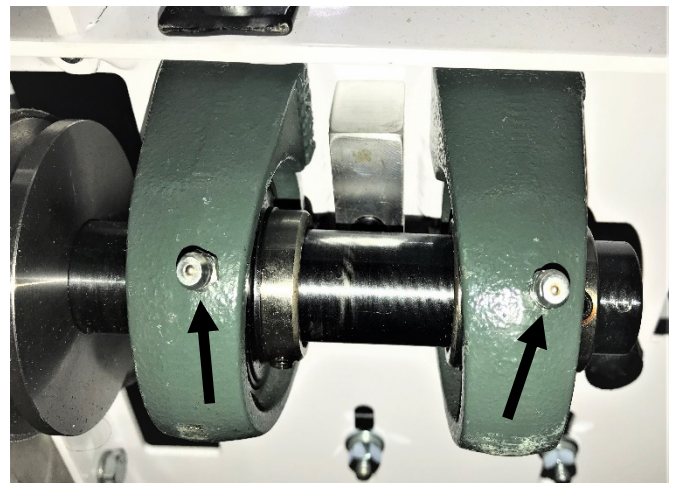

Right and Left Blade Shaft Bearing Grease Fittings

Inspect the Drive Belt

Inspect the drive belt after the first four hours of use and then daily for tension or wear. Re-tension or replace as required.

Belt Tensioning

DO NOT exceed the manufacturer's recommended belt tension settings when tensioning belts.

NOTE: Over-tensioning belts may damage the motor. Under-tensioning belts may cause slippage, shorter belt life, and/or poor saw performance. Squealing belts indicate looseness.

Tensioning the Drive Belts

There is a spring loaded idler arm assembly that maintains a constant tension on the belt. However, if the idler is unable to provide proper tension, use the following procedure to add increased tension to the belt:

1. Loosen the four motor mount adapter nuts underneath the frame.

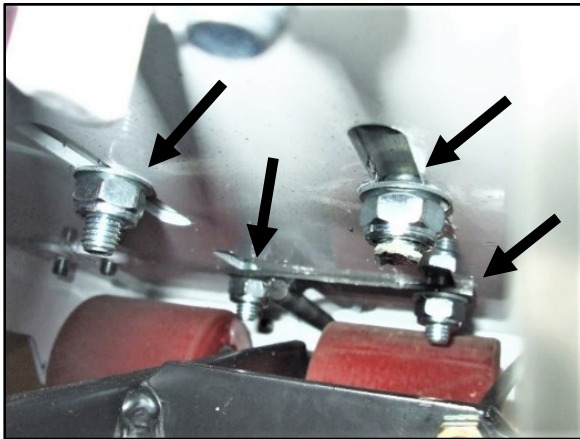

Motor Mount Adapter Nuts

2. Disconnect the idler arm spring from the idler arm.
3. Manually push the motor toward the rear of the saw. This will add additional tension to the drive belt.
4. Retighten the four motor mount adapter nuts.
5. Re-connect the idler arm spring to the idler arm.

Replacing the Drive Belts

1. Loosen the four motor mount adapter nuts underneath the frame.
2. Disconnect the idler arm spring from the idler arm.
3. Manually push the motor forward to loosen the belt.
4. Remove the belt from the crankshaft sheave and the blade shaft sheave.
5. Fit the new belt around the blade shaft sheave, and then pull it up and fit it around the outer groove on the crankshaft sheave.
6. Manually push the motor toward the rear of the saw to add tension to the belt.
7. Retighten the four motor mount adapter nuts.
8. Re-connect the idler arm spring to the idler arm.

Check Engine Oil Level

Ensure the engine is off, in a level position, and has had time to cool down.

1. Remove the dipstick from the lower back side of the engine.
2. Wipe the dipstick off with a clean rag.
3. Re-insert the dipstick back into the filler neck but do not tighten.
4. Pull the dipstick out and visually check the oil level.
5. If the oil level is low, fill with SAE-10W30 oil to the point of almost overflowing from the filler neck.
6. Re-install the dipstick and tighten to secure.

Check Fuel Level

Ensure the engine is off, in a level position, and has had time to cool down.

1. Remove the fuel filler cap and visually inspect the fuel level in the tank.
2. If the tank is low, refill using 87 octane unleaded fuel.
3. Fill only to the bottom of the fuel filler neck or lower. **DO NOT OVERFILL THE TANK.**

Check Air Filter

Ensure the engine is off, and has had time to cool down.

1. Remove the wing nut from the air cleaner cover and remove the cover.
2. Visually inspect the filter elements.
3. If no cleaning is required and there is no damage, re-install air cleaner cover.

100 Hour Service

Clean the Air Filter

Ensure the engine is off, and has had time to cool down.

1. Remove the wing nut from the air cleaner cover and remove the cover.
2. Remove the wing nut from the air filter, and remove the filter.
3. Remove the foam filter from the paper filter.
4. Tap the paper filter element on a hard surface to remove any dirt or blow low pressure air (not to exceed 30 psi) through the filter from the inside.

NOTE: Do not brush the dirt off of the filter, brushing will force dirt into the fibers.

5. Clean the foam filter in warm soapy water, rinse, and allow to dry thoroughly.
6. Wipe the dirt from the inside of the air cleaner housing with a damp rag. Be careful not to wipe any dirt into the air duct that leads to the carburetor.
7. Place the foam filter over the paper filter element and re-install the air cleaner filter.
8. Tighten the filter with the wing nut.
9. Re-install the air cleaner cover and tighten with the wing nut.

Replace the Engine Oil

Drain the used oil when the engine is warm. Warm oil drains quickly and completely.

1. Place a suitable container below the oil drain hose assembly to catch the used oil.
2. Remove the oil filler cap/dipstick from the engine.
3. Remove the 1/4" cap from the end of the oil drain hose and allow oil to drain from the engine.
4. When all oil has been drained, replace the cap onto the drain hose and tighten completely.
5. Dispose of the oil in accordance with all city, state, and federal regulations.
6. With the engine in a level position, fill with the recommended oil (see the gas engine specifications located in the Introduction section of this manual).
7. Fill to the upper limit point (bottom edge of the oil fill neck).
8. Re-install the oil filler cap/dipstick and tighten to secure.

Clean the Sediment Cup



WARNING

Gasoline is highly flammable and explosive, serious burns and injuries can occur when handling fuel.

- Stop the engine and keep heat, sparks, and flames away
- Handle fuel only outdoors
- Wipe up spills immediately

1. Move the fuel valve to the OFF position.

2. Using a 10mm wrench, loosen the sediment cup (located below the fuel shut off valve).



Sediment Cup

3. Remove the sediment cup and o-ring.
4. Wash the sediment cup in non-flammable solvent and dry it completely.
5. Place the o-ring back into the fuel valve and re-install the sediment cup.
6. Use a 10mm wrench to tighten the sediment cup securely.
7. Move the fuel valve to the ON position and check for leaks.
8. Replace the o-ring if there are any leaks.

Check and Adjust Spark Plug

1. Disconnect the spark plug wire.
2. Remove the spark plug using a 13/16" spark plug wrench (Honda & Lifan engines) or a 5/8" spark plug wrench (Vanguard engine).
3. Inspect the spark plug. If there is excessive fouling, damage, or the sealing washer is in poor condition, replace the plug.
4. Measure the spark plug gap with a wire type feeler gauge. Correct the gap if necessary in accordance with the specifications called out in the Introduction section of this manual.
5. Carefully install the spark plug by hand until it is seated.
6. Tighten the spark plug using the applicable spark plug wrench to compress the sealing washer.
7. When installing a new spark plug, tighten 1/2 turn after the spark plug seats.

8. When re-installing the original spark plug, tighten 1/8 – 1/4 turn after the spark plug seats.
9. Reconnect the spark plug wire.

Clean the Spark Arrester

Honda & Lifan Engines

Ensure the engine is off, and has had time to cool down.

1. Remove the two 4 mm screws from the exhaust deflector and set the deflector aside.
2. Remove the four 5 mm screws from the muffler protector and set the muffler protector aside.
3. Remove the 4 mm screw from the spark arrester and remove the spark arrester from the muffler.

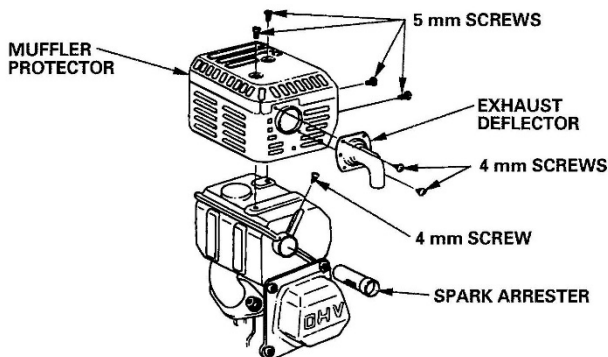

4. Use a brush to remove carbon deposits from the spark arrester screen. Be careful not to damage the screen. Replace the spark arrester if it breaks or is damaged.
5. Re-install the spark arrester into the muffler and secure with the 4 mm screw.
6. Re-install the muffler protector and secure using the four 5 mm screws.
7. Re-install the exhaust deflector and secure using the two 4 mm screws.

Vanguard Engine

Ensure the engine is off, and has had time to cool down.

1. Remove the three 4 mm screws from the exhaust deflector and set the deflector aside.



Exhaust Deflector (Vanguard Engine)

2. Remove the spark arrester from the muffler.



Spark Arrester (Vanguard Engine)

3. Use a brush to remove carbon deposits from the spark arrester screen. Be careful not to damage the screen. Replace the spark arrester if it breaks or is damaged.
4. Re-install the spark arrester into the muffler.
5. Re-install the exhaust deflector and secure using the three 4 mm screws.

Yearly Service

Replace the Air Filter

Ensure the engine is off, and has had time to cool down.

1. Remove the wing nut from the air cleaner cover and remove the cover.
2. Remove the wing nut from the air filter, and remove the filter.

3. Wipe the dirt from the inside of the air cleaner housing with a damp rag. Be careful not to wipe any dirt into the air duct that leads to the carburetor.
4. Place the foam filter over the paper filter element and install the air cleaner filter.
5. Tighten the filter with the wing nut.
6. Re-install the air cleaner cover and tighten with the wing nut.

Replace the Spark Plug

1. Disconnect the spark plug wire.
2. Remove the spark plug using a 13/16" spark plug wrench (Honda & Lifan engines) or a 5/8" spark plug wrench (Vanguard engine).

Check the spark plug gap on the new plug with a wire type feeler gauge. Correct the gap if necessary in accordance with the specifications called out in the Introduction section of this manual.

3. Carefully install the spark plug by hand until it is seated.
4. Tighten the spark plug 1/2 turn using the applicable spark plug wrench to compress the sealing washer.
5. Reconnect the spark plug wire.

General Maintenance

Motor



WARNING



Let the motor cool down prior to servicing the saw.
DO NOT service the saw with the motor running (unless stated otherwise).

Refer to the motor manual and manufacturer for a full motor maintenance schedule and additional motor maintenance information.

Disconnecting the Power to the Motor

Whenever maintenance is being conducted on the saw, disconnect the power to the motor by unplugging the power cord.

Inner Blade Flange



Inner Flange

The inner blade flange may be taken off the blade shaft to clean or replace the part.

Installing the Inner Blade Flange

1. Inspect the inner blade flange for damages and clean or replace as necessary.
 2. Place the flange onto the stepped down portion of the blade shaft and align it with the blade shaft key.
 3. Apply Loctite 262 (red) or an equivalent to the setscrew threads.
 4. Place the setscrew into the flange's setscrew hole and tighten the screw down to the blade shaft key to secure the flange.
- Note: Always make sure the flange is secure prior to operating the saw.*

Removing the Inner Blade Flange

1. Remove the setscrew from the back of the inner blade flange using an Allen wrench.
2. Remove the flange from the blade shaft.

Wheels



WARNING



- Raise the saw to a proper height for access when working underneath the saw. Use chocks to block the wheels, and fit blocks or jacks under the frame edges at the front and back of the frame for additional support.
- Always wear safety glasses when removing retaining rings.



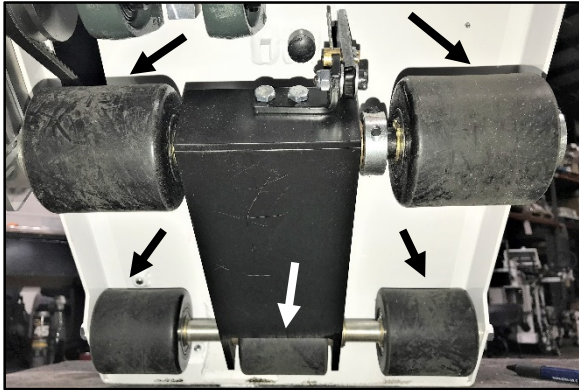

Front and Rear Wheels

Replacing the Front Wheels

Inspect the front wheels regularly for damages or wear and replace as necessary.

1. Loosen the two socket head screws on the front wheel shaft collar and pull the collar off.



Front Wheel Shaft Collar

2. Remove the wheel from the wheel shaft and place a new wheel onto the wheel shaft.
3. Reinstall the front wheel shaft collar and tighten the two socket head screws to secure.
4. Repeat steps 1–3 to replace the second wheel.

Replacing the Rear Wheels

Inspect the rear wheels regularly for damages or wear and replace as necessary.

1. Remove the two bolts and associated washers from both ends of the rear wheel shaft that attach the axle weldment to the frame.



Rear Wheel Bolts

2. Loosen the set screw in the cable pivot pin.

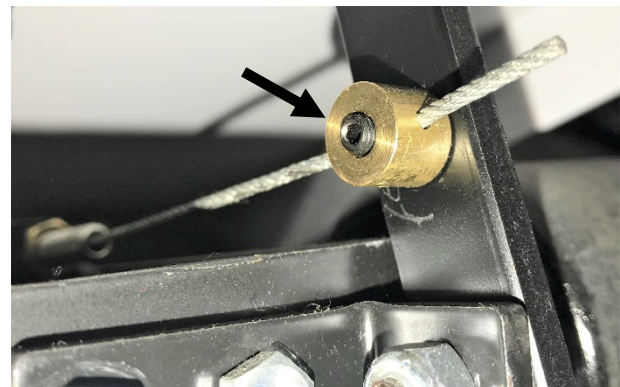

Cable Pivot Pin Set Screw

3. Remove the cable nut from the cable end that attaches to the axle weldment.

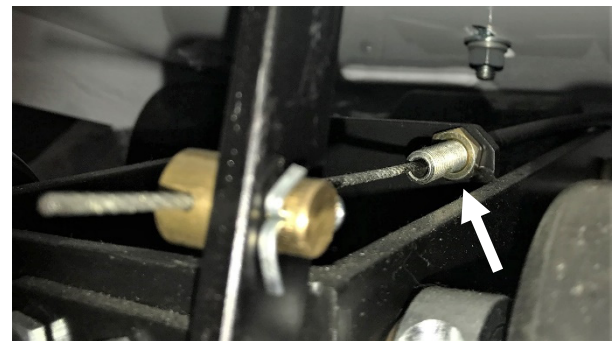

Cable Nut

4. Remove the axle weldment from the frame.
5. Remove the retaining ring from each outer wheel, and then remove the outer wheels from the axle.
6. Remove the inner retaining ring from either side of the middle wheel, slide the axle in the opposite direction, and remove the middle wheel.
7. Fit a new wheel into the middle wheel position, slide the axle through the wheel, and realign the axle with the carriage.

8. Snap the inner retaining ring into place on the rear axle shaft to secure the middle wheel.
9. Place a new wheel onto each end of the axle.
10. Snap the retaining ring for each outer wheel into place on the axle to secure both wheels.
11. Reinstall the cable to the axle weldment and tighten the cable nut to secure.
12. Reinsert the cable into the cable pivot pin and tighten the setscrew to secure.
13. Fit and align the axle weldment underneath the frame.
14. Replace and tighten the two bolts and associated washers through the frame into each end of the rear wheel shaft.

Lifting and Transporting

Lifting



CAUTION

Always use a strap to lift the machine. Ensure the strap is rated high enough to handle the load.

1. Ensure the work area is clear of any obstructions and all personnel are at a safe distance prior to lifting the machine.
2. Using a properly rated strap, place the strap around the frame lift using a basket style hitch.

3. Slowly lift the machine only high enough to conduct the required work.

Transporting

Always secure the machine using tie down straps to avoid damage during transport.

Storing

Complete the tasks listed below prior to storing the saw for longer time frames:

- Lower the saw completely to remove strain on the lifting mechanism.
- Clean and wipe down the saw to remove dust and debris from saw components.
- Refer to the motor manual for all motor recommendations prior to storing.
- Store the saw in a dry area, protected from outdoor elements and out of reach from children.

Disposal

Dispose of the saw when it's no longer repairable, and/or contains safety hazards not worth repairing or maintaining.

Transport the saw to a salvage yard or recycling facility.

REFERENCES

Appendix A

Troubleshooting

Troubleshooting the CC150XL-EE6 Series		
Symptom	Problem	Solution
1. Electric motor will not start.	Not connected to power source?	Connect to power source.
	Starter switch in OFF position?	Move switch to ON position.
2. Gas engine will not start.	Fuel valve OFF?	Move fuel valve to ON position.
	Engine switch OFF?	Move engine switch to ON position.
	Choke open?	Close choke.
	Out of fuel?	Refuel.
	Bad fuel?	Drain fuel tank and carburetor. Refill with fresh fuel
	Faulty spark plug?	Gap or replace spark plug.
	Low oil level?	Fill with recommended oil to proper level.
3. Gas engine lacks power.	Air filter element restricted?	Clean or replace air filter element.
4. Saw will not lower.	Handlebar lever out?	Push lever in to lower saw.
5. Saw will not lower completely.	Blade misaligned?	Adjust skid plates to align blade.
6. Blade does not cut straight.	Excessive force used when sawing?	Reduce forward speed. DO NOT twist blade from side to side.
	Wrong blade?	Contact dealer/manufacturer of blade.
	Loose or worn wheels?	Check that all wheels roll freely and replace as required.
7. Short belt life.	Loose belts causing slippage?	Check and adjust belt tension.
	Sheaves misaligned?	Use straightedge to check blade shaft sheave alignment. Adjust as necessary.
	Worn sheave grooves?	Check for groove wear and replace sheaves when necessary.
	Overheating of belts?	Check and adjust belt tension.

REFERENCES

8. Saw is spalling.	Bad blade?	Check blade for glazing, warping, missing segments and replace as necessary.
	Bad skid plate?	Check skid plate for excessive wear, burrs, twists, bends or irregularities and replace as necessary.
	Uneven spring tension?	Check spring box tension springs and replace as necessary.
	Improper belt tension?	Check drive belt and idler for proper tension.
	Clean cutting surface?	Ensure the cutting surface is free of any debris that can cause the skid plate to raise.

REFERENCES

Appendix B

Belt Tension Specifications

	New Belt	Used Belt
Static Tension (per rib/strand)	30 to 32 lbf.	26 to 28 lbf.
Static Belt Pull (total pull)	60 to 64 lbf.	51 to 56 lbf.
Rib/Strand Deflection Distance	0.14 in.	0.14 in.
Rib/Strand Deflection Force	2.0 to 2.1 lbf.	1.7 to 1.8 lbf.
Sonic Tension Meter	133 to 143 N	114 to 124 N
Belt Frequency	107 to 111 Hz.	99 to 103 Hz.

Power Cord Specifications

CC125BXL-EE6 Recommended Power Cord Gauge - 1 Phase						
Horsepower	Phase	Voltage	Amps	50ft Cord	100ft Cord	150ft Cord
2.5	1	115	21	#10	#8	#6
2.5	1	230	11	#14	#12	#10

NOTE: Electric saws do not ship with electric cord or pigtails



CAUTION

Use of a wire gauge that is too small will cause loss of power or overheating and will damage the electric motor

Appendix C

Additional Resources

1. Diamond Products (www.diamondproducts.com)
 - *CC150XL-EE Saw Parts List; #1802697*
 - *A Guide for Professional Concrete Cutters*
 - *Training Manual – Introduction to Diamond Blades, Bits, and Equipment*
 - *Diamond Products' Equipment Catalog*
 - *Diamond Products' Website (www.diamondproducts.com)*

2. Concrete Sawing and Drilling Association (www.csda.org)
 - The CSDA has many helpful concrete cutting publications available to members and non-members.

3. Association of Equipment Manufacturers (www.aem.org)
 - The AEM has a variety of safety and technical manuals available for various types of equipment, along with a list of industry-standardized safety symbols.

4. Occupational Safety & Health Administration (OSHA) (www.osha.gov/)
 - OSHA provides information on work-related safety and health practices.

5. The National Institute for Occupational Safety and Health (NIOSH) (www.cdc.gov/NIOSH/)
 - NIOSH provides information on work-related safety and health practices.

REFERENCES

Appendix D

Model and Serial Numbers

Record the saw's serial number below for future reference and customer service purposes.

Serial Number	
---------------	--

Record the motor's model and serial numbers below for future reference and customer service purposes.

Model Number	
Serial Number	

REFERENCES

EQUIPMENT AND PARTS WARRANTY

Diamond Products warrants all equipment manufactured by it against defects in workmanship or materials for a period of one (1) year from the date of shipment to Customer.

The responsibility of Diamond Products under this Warranty is limited to replacement or repair of defective parts at Diamond Products' Elyria, Ohio factory, or at a point designated by it, of such parts as shall appear to us upon inspection at such parts, to have been defective in material or workmanship, with expense for transportation and labor borne by Customer.

In no event shall Diamond Products be liable for consequential or incidental damages arising out of the failure of any Product to operate properly.

Integral units such as engines, electric motors, batteries, transmissions, etc., are excluded from this Warranty and are subject to the prime manufacturer's warranty.

THIS WARRANTY IS IN LIEU OF ALL OTHER WARRANTIES, EXPRESSED OR IMPLIED, AND ALL SUCH OTHER WARRANTIES ARE HEREBY DISCLAIMED.



333 Prospect Street, Elyria, Ohio 44035
(440) 323-4616 • (800) 321-5336 • Fax (800) 634-4035
www.diamondproducts.com