

KEEP FOR FUTURE REFERENCE

SERVICE MANUAL



908 W. Main • P.O. Box 368
Laurel, MT USA 59044
800-548-7341 (phone)
406-628-8231 (phone)
406-628-8354 (fax)
www.WPG.com

 **INTENDED FOR USE BY SKILLED
TECHNICAL PROFESSIONALS • READ
AND UNDERSTAND BEFORE SERVICING**



**DC-VOLTAGE
POWER SYSTEM
WITH DUAL VACUUM
SYSTEM AND INTELLI-GRIP®
TECHNOLOGY**

(SOFTWARE VERSION 7.6)

Stock number: 36106



TABLE OF CONTENTS

BEFORE SERVICING LIFTER	2
SERVICE SCHEDULE	2
SERVICE FEATURES	3
INTELLI-GRIP[®] DIAGNOSTIC CODES	4
INTELLI-GRIP[®] OPERATOR MENUS	10
TO ACCESS AND NAVIGATE THE OPERATOR MENUS.....	10
TO CHANGE THE SCREEN LANGUAGE	11
TO USE THE LIFTER AT HIGH ELEVATION	11
TO CHANGE THE VACUUM DETECTION THRESHOLD	12
TO CHANGE THE LEAK RATE THRESHOLD	12
TO CHANGE MOBILE APP SETTINGS	13
TO VIEW SYSTEM INFORMATION	14
BATTERY CHARGER TEST	15
SERVICE PROCEDURES	16
AIR FILTER MAINTENANCE – 0.1 OZ BOWL SIZE	16
Filter Service Procedure.....	16
VACUUM PUMP MAINTENANCE – MODEL 1034204.....	18
Replacing the Diaphragm.....	18
Replacing the Head Assembly.....	18
REPLACEMENT PARTS	19
COPYRIGHT NOTICE	20

BEFORE SERVICING LIFTER



Disconnect battery before servicing lifter.

Disconnect the electrical connectors (figs. 1A-C).

Service personnel must read and understand the lifter's *OPERATING INSTRUCTIONS* – especially the “INSPECTIONS AND TESTS” and “MAINTENANCE” sections – before servicing the vacuum lifter. Many of the following discussions assume knowledge of the *OPERATING INSTRUCTIONS*.

Note: The final section of the lifter's OPERATING INSTRUCTIONS may contain wiring and/or hose-routing diagrams for reference when servicing or troubleshooting the lifter.

SERVICE SCHEDULE

Service must be performed whenever a deficiency is indicated by routine inspections or tests. Follow the “INSPECTIONS AND TESTS” section of the *OPERATING INSTRUCTIONS*. Any service warranted must be performed before resuming normal operation of the lifter.

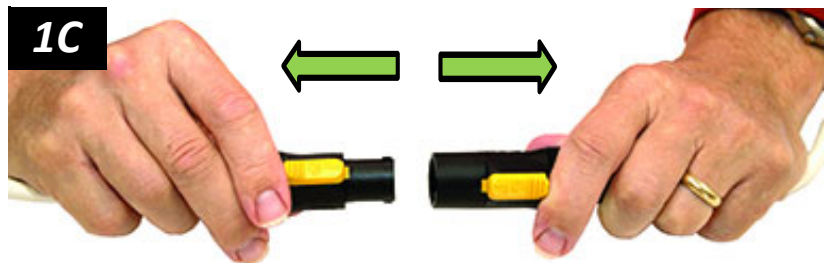
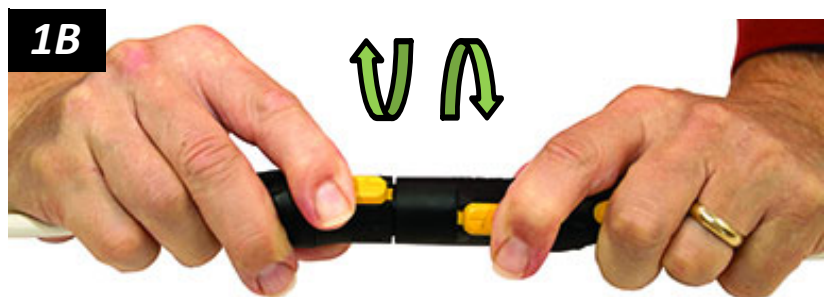
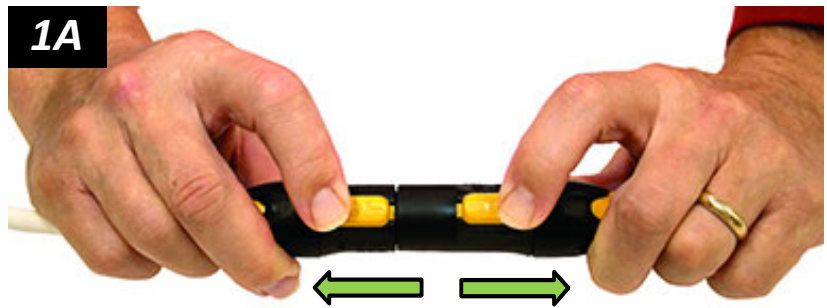

SERVICE FEATURES

Components shown here are underlined> on their first appearance in each section to follow.¹

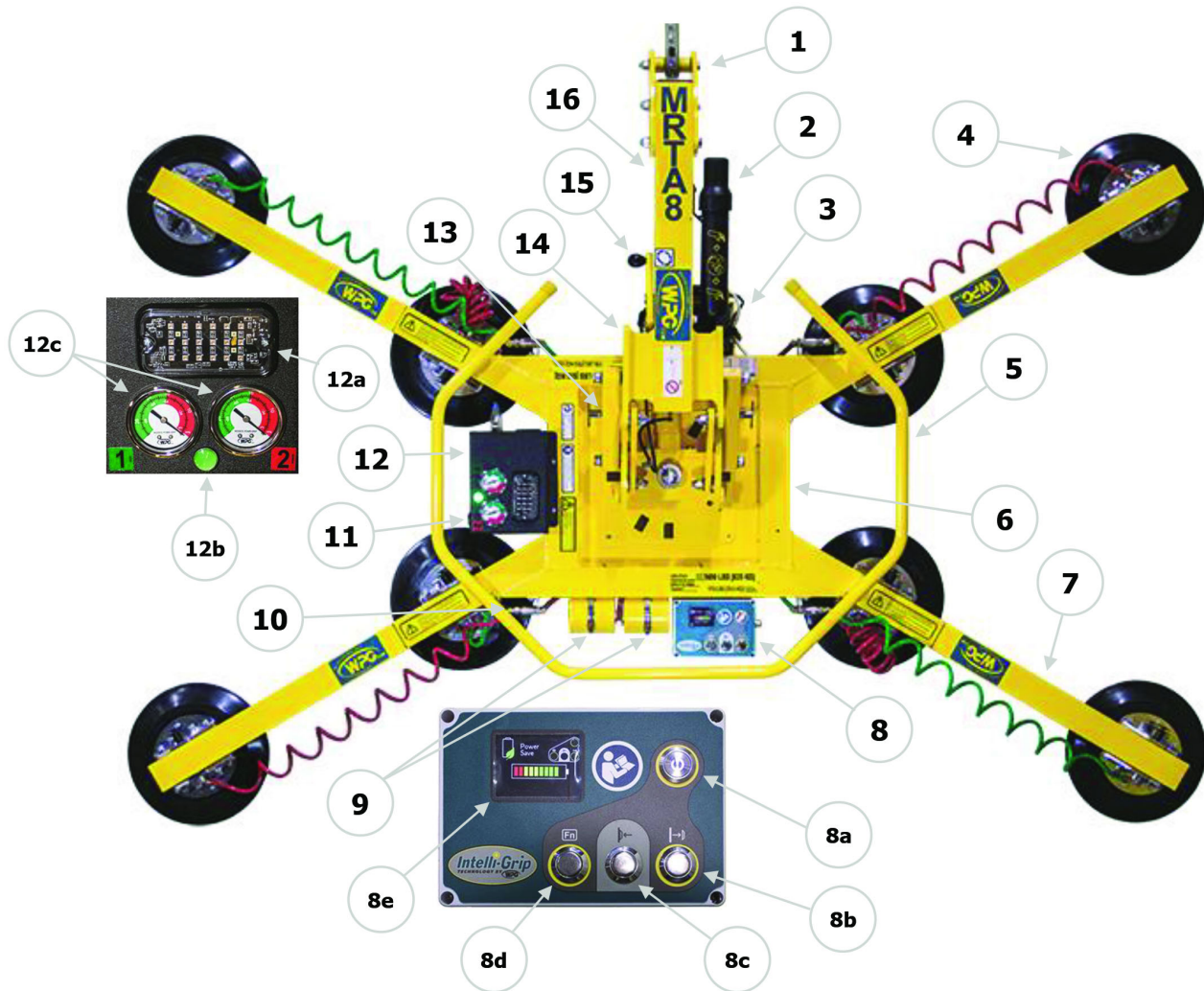

MRTA811LDC3 shown (component locations vary among models)

- | | | | | | |
|---|-----------------------------------|----|-------------------------------|-----|---|
| 1 | LIFT POINT | 8a | POWER BUTTON | 12 | Cover for VACUUM PUMP, AIR FILTERS and VACUUM SENSORS |
| 2 | INSTRUCTION CANISTER | 8b | “RELEASE” BUTTON | 12a | STROBE LIGHT |
| 3 | BATTERY CHARGER | 8c | “ATTACH” BUTTON | 12b | VACUUM LIFT LIGHT |
| 4 | VACUUM PAD with MOVABLE PAD MOUNT | 8d | “FUNCTION” BUTTON | 12c | VACUUM GAUGES |
| 5 | CONTROL HANDLE | 8e | LCD SCREEN with BATTERY GAUGE | 13 | TILT LOCK |
| 6 | PAD FRAME | 9 | VACUUM RESERVE TANKS | 14 | BATTERY (hidden) |
| 7 | EXTENSION ARM | 10 | QUICK CONNECTOR | 15 | ROTATION RELEASE LEVER |
| 8 | INTELLI-GRIP® CONTROL UNIT | 11 | NOTIFICATION BUZZER | 16 | LIFT BAR |

1..... Some components may not be applicable, depending on the lifter in question.

INTELLI-GRIP® DIAGNOSTIC CODES

Refer to the following table whenever a diagnostic code appears on the LCD screen. Codes are listed in alphanumeric order. If the Operator Explanations/Directions do not resolve the issue, follow the Service Personnel Directions. When applicable, search for the lifter's Model Number on www.wpg.com and select the “Troubleshooting” link on the product page. Relevant parts are listed in **“REPLACEMENT PARTS”**.

Code	On-Screen Message	Buzzer Pattern	Strobe Light Activity	Operator Explanations/Directions	Service Personnel Directions
B00	“Low 12V Battery (#)”	1 chirp every 2 seconds	(none)	Charge 12V <u>battery</u> or, if necessary, replace it (see “MAINTENANCE: 12-VOLT BATTERY RECHARGE” in lifter's <i>OPERATING INSTRUCTIONS</i>). Cold battery may need to be warmed and/or charged more often.	Check for faulty 12V <u>battery</u> or malfunctioning charging system. Replace parts as needed.
B01	“Lockout (low 12V battery) (#)”	continuous	(none)	Once “Power Save” mode is activated, “attach” and “release” functions are prevented because 12V <u>battery</u> energy is insufficient. Charge battery before next lift (see “MAINTENANCE: 12-VOLT BATTERY RECHARGE” in lifter's <i>OPERATING INSTRUCTIONS</i>).	Check for faulty 12V <u>battery</u> or malfunctioning charging system. Replace parts as needed.
B02	“Replace 12V battery?”	1 chirp per minute	(none)	Check condition of 12V <u>battery</u> (see “OPERATION: BEFORE USING THE LIFTER: Checking the 12-Volt Battery” and “MAINTENANCE: 12-VOLT BATTERY RECHARGE” in lifter's <i>OPERATING INSTRUCTIONS</i>). Since cold battery may prematurely activate this notification, warm battery and retest when appropriate. Replace battery as needed. Note: This notification can be activated in error if <u>battery charger</u> is plugged into power source while lifter is powered up. If so, power down lifter, disconnect charger from power source, and power up again. If code persists, check battery condition as directed above.	Check for fault(s) with 12V <u>battery</u> or charging system. Replace parts as needed.
B03	“Charge 12V battery soon”	1 chirp per minute	(none)	Charge 12V <u>battery</u> (see “MAINTENANCE: 12-VOLT BATTERY RECHARGE” in lifter's <i>OPERATING INSTRUCTIONS</i>)	N/A
B09	“Replace 9V battery?”	1 chirp per minute	(none)	Replace 9V battery for <u>notification buzzer</u> as needed (see “MAINTENANCE: Notification Buzzer Battery Replacement” in lifter's <i>OPERATING INSTRUCTIONS</i>).	Check 9V battery voltage with multi-meter. If battery is OK, check for bad connection in battery holder or associated wiring.
C00	“Fail-safe on module”	continuous	on	Fail-safe mode has been activated, to prevent potential injury. Service is required.	Disconnect 12V <u>battery</u> and replace <u>Intelli-Grip® control unit</u> .

INTELLI-GRIP® DIAGNOSTIC CODES

Code	On-Screen Message	Buzzer Pattern	Strobe Light Activity	Operator Explanations/Directions	Service Personnel Directions
C011	“Communication failure, module 1”	fast chirp	(none)	If code does not clear automatically, service is required.	Disconnect 12V <u>battery</u> and replace <u>Intelli-Grip® control unit</u> .
C021	“Internal error, module 1”	continuous	(none)	If code does not clear automatically, service is required.	Disconnect 12V battery and replace <u>Intelli-Grip® control unit</u> .
C04	“Module revision not compatible”	1 chirp every 2 seconds	(none)	Make sure lifter is used within Operating Temperatures (see “SPECIFICATIONS” in lifter’s <i>OPERATING INSTRUCTIONS</i>). Then power lifter down and up again. If code persists, service is required.	Disconnect 12V battery and replace <u>Intelli-Grip® control unit</u> .
C05	“Module revision lockout”	continuous (while button is held)	(none)	Once “Power Save” mode is activated, “attach” and “release” functions are prevented in connection with Code C04. Service is required.	Disconnect 12V battery and replace <u>Intelli-Grip® control unit</u> .
C06	“Control head revision not compatible”	1 chirp every 2 seconds	(none)	Incompatible version of software was installed or <u>Intelli-Grip® control unit</u> has failed. Service is required.	Install current software or disconnect 12V <u>battery</u> and replace <u>Intelli-Grip® control unit</u> , as needed.
C07	“Control head revision lockout”	continuous (while button is held)	(none)	Once “Power Save” mode is activated, “attach” and “release” functions are prevented in connection with Code C06. Service is required.	Install current software or disconnect 12V <u>battery</u> and replace <u>Intelli-Grip® control unit</u> , as needed.
E00 E01 E02 E03 E04	“EEPROM error, cell #”	occasional chirp	(none)	Memory error detected. Service is required.	Impact of memory error can vary. Disconnect 12V <u>battery</u> and replace <u>Intelli-Grip® control unit</u> to resolve.
I000	“I2C error (#)”	single chirp	(none)	If code does not clear automatically, service is required.	Disconnect 12V <u>battery</u> and replace <u>Intelli-Grip® control unit</u> .
N00	“Automatic attach”	(none)	(none)	System activated “attach” mode as precaution because significant vacuum was detected, even though no one initiated “attach” function. No corrective action is necessary.	N/A
N01	“Automatic attach”	(none)	(none)	System activated “attach” mode as precaution because load did not release completely. No corrective action is necessary.	N/A

INTELLI-GRIP® DIAGNOSTIC CODES

Code	On-Screen Message	Buzzer Pattern	Strobe Light Activity	Operator Explanations/Directions	Service Personnel Directions
N02	“Automatic attach”	(none)	(none)	System activated “attach” mode as precaution when lifter was powered up, because power was previously lost while load was attached. No corrective action is necessary.	N/A
N03	“Unable to turn module power off”	1 chirp every 2 seconds	(none)	Remove 9V battery. Disconnect connector between 12V <u>battery</u> and vacuum generating system. Charge battery completely (see “MAINTENANCE: 12-VOLT BATTERY RECHARGE” in lifter’s <i>OPERATING INSTRUCTIONS</i>). Then reconnect battery and try to power down again. If code persists, disconnect connector. Service is required.	Disconnect 12V <u>battery</u> and replace <u>Intelli-Grip® control unit</u> .
N04	“Failed to turn controls power off”	1 chirp every 2 seconds	(none)	Remove 9V battery. Disconnect connector between 12V <u>battery</u> and vacuum generating system. Charge battery completely (see “MAINTENANCE: 12-VOLT BATTERY RECHARGE” in lifter’s <i>OPERATING INSTRUCTIONS</i>). Then reconnect battery and try to power down again. If code persists, disconnect connector. Service is required.	Disconnect 12V <u>battery</u> and replace <u>Intelli-Grip® control unit</u> .
N05	“Unable to turn module power on”	1 chirp every 2 seconds	(none)	Charge 12V <u>battery</u> (see “MAINTENANCE: 12-VOLT BATTERY RECHARGE” in lifter’s <i>OPERATING INSTRUCTIONS</i>). Then power lifter up again. If code persists, service is required.	Disconnect 12V battery and replace <u>Intelli-Grip® control unit</u> .
N06	“Power-down reminder”	2 chirps	on briefly	Power down to prevent 12V <u>battery</u> discharge when lifter is not in use.	N/A
N07	“Auto power-down disabled”	(none)	(none)	Automatic power-down is prevented. Power down lifter and power up again. If code persists, service is required.	Check for other Diagnostic Codes and perform service as directed.
N08	“Powering down in # seconds”	1 chirp per minute	(none)	Lifter will automatically power down in number of seconds shown. Press any button to cancel action.	N/A
N10	“App-support hardware fault”	(none)	(none)	Fault is detected in hardware that enables communication with mobile app. Power down lifter and power up again. If code persists, service is required.	Disconnect 12V <u>battery</u> and replace <u>Intelli-Grip® control unit</u> to resolve.
U00	“WARNING! Is load attached?”	fast chirp	on	Attempt was made to power down lifter while load was still detected. Lower load onto stable support and release load before powering down lifter.	N/A

INTELLI-GRIP® DIAGNOSTIC CODES

Code	On-Screen Message	Buzzer Pattern	Strobe Light Activity	Operator Explanations/Directions	Service Personnel Directions
U01	“Also hold [Fn] to power down”	(none)	(none)	Hold <u>“function” button</u> and <u>“power” button</u> at same time to power down lifter.	N/A
U02	“Turn off? Let go of buttons”	(none)	(possible)	Use only <u>“function” button</u> and <u>“power” button</u> to power down lifter. Lifter cannot be powered down while any other button is pressed.	N/A
U03	“Timed release: # seconds”	1 chirp per button press	on	Timed release function is activated for number of seconds shown (see “OPERATION: TO RELEASE THE PADS FROM THE LOAD” in lifter’s <i>OPERATING INSTRUCTIONS</i>). Press <u>“function” button</u> to cancel action or press <u>“attach” button</u> to override. No corrective action is necessary.	N/A
U04	“Also hold [Fn] to release”	(none)	(none)	Hold <u>“function” button</u> and <u>“release” button</u> at same time to release load.	N/A
U06	“Let go of [Fn] and release”	(none)	on	Use only <u>“attach” button</u> to attach load. While “attach” button is pressed, lifter does not respond to pressing any other button. Release all buttons and press buttons again to activate different function.	N/A
U08	“Menu not available in Attach”	(none)	(none)	Operator menus cannot be accessed while lifter is attached to load.	N/A
U09	“Counterweight not retracted”	continuous	on	“Release” function is prevented because counterweight is not positioned correctly. Reposition counterweight as directed (see Counter-Balancer <i>OPERATING INSTRUCTIONS</i>).	N/A
U10	“Use POWER button for Live Stats”	(none)	(none)	<u>“Power” button</u> (not <u>“function” button</u>) is now used to access Live Stats. No corrective action is necessary.	N/A
U11	“Testing battery - wait to attach”	(none)	(none)	“Attach” function is prevented because <u>battery</u> test is currently in progress. Wait until <u>vacuum pump</u> stops running and try again.	N/A
V000	“INSUFFICIENT VACUUM!”	continuous	on	Immediately lower load onto stable support until adequate vacuum can be obtained. Check load and <u>vacuum pads</u> for damage. Consult relevant topics in “ASSEMBLY”, “OPERATION”, “INSPECTIONS AND TESTS”, and “MAINTENANCE” in lifter’s <i>OPERATING INSTRUCTIONS</i> .	Find leak(s) in vacuum system and replace parts as needed.

INTELLI-GRIP® DIAGNOSTIC CODES

Code	On-Screen Message	Buzzer Pattern	Strobe Light Activity	Operator Explanations/Directions	Service Personnel Directions
V001 V002 V003 V004	"INSUFFICIENT VACUUM #!" (# indicates relevant vacuum circuit)	continuous	on	Immediately lower load onto stable support until adequate vacuum can be obtained in vacuum circuit indicated. Check load and <u>vacuum pads</u> for damage. Consult relevant topics in "ASSEMBLY", "OPERATION", "INSPECTIONS AND TESTS", and "MAINTENANCE" in lifter's <i>OPERATING INSTRUCTIONS</i> . This Code can be activated in connection with Code N00.	Find leak(s) in relevant vacuum circuit and replace parts as needed.
V011 V012 V013 V014 V015	"Vacuum decrease on circuit #" (# indicates relevant vacuum circuit)	3 chirps	(none)	Vacuum decreased at a greater rate than expected in circuit(s) indicated. Possible causes include bouncing or landing load, as well as use on rough or porous loads and other sources of vacuum leaks. Consult relevant topics in "ASSEMBLY", "OPERATION", "INSPECTIONS AND TESTS", and "MAINTENANCE" in lifter's <i>OPERATING INSTRUCTIONS</i> to eliminate leaks when possible. When appropriate, you can also adjust sensitivity to vacuum level reductions (see " TO CHANGE THE LEAK RATE THRESHOLD ").	Determine whether reduction in vacuum level is due to leaks or other circumstances. Repair any leak(s) found in relevant vacuum circuit(s) or reduce sensitivity to vacuum reductions, as appropriate.
V020	"Vacuum not increasing normally"	1 chirp every 2 seconds	on	Although lifter began to attach, vacuum level did not increase at normal rate. Make sure all <u>vacuum pads</u> seal securely (see relevant topics in "OPERATION" in lifter's <i>OPERATING INSTRUCTIONS</i>). This Code can be activated by use at high elevation. If so, contact WPG for directions.	Check for fault(s) in vacuum system. Replace parts as needed.
V03A V03B	"Pump running excessively"	1 chirp every 2 seconds	(none)	<u>Vacuum pump</u> is running more often than normal. Likely causes include a significant vacuum leak or difficulty achieving minimum vacuum level due to high elevation. In case of suspected leak, check for fault(s) in vacuum system (see relevant topics in "ASSEMBLY", "OPERATION", "INSPECTIONS AND TESTS", and "MAINTENANCE" in lifter's <i>OPERATING INSTRUCTIONS</i>). In case of high elevation, contact WPG for directions.	Check for fault(s) in relevant <u>vacuum pump</u> (see " VACUUM PUMP MAINTENANCE – MODEL 1034204 ") or in vacuum system. Replace parts as needed.

INTELLI-GRIP® DIAGNOSTIC CODES

Code	On-Screen Message	Buzzer Pattern	Strobe Light Activity	Operator Explanations/Directions	Service Personnel Directions
V040	"Lockout (vacuum sensor error)"	continuous	(none)	Once "Power Save" mode is activated, "attach" and "release" functions are prevented due to a <u>vacuum sensor</u> malfunction. Make sure sensor connectors are attached correctly.	Check wiring and connector for each <u>vacuum sensor</u> . Temporarily switch sensor connectors to determine whether to replace <u>Intelli-Grip® control unit</u> or manifold assembly (including sensors).
V050	"DANGER! INSUFFICIENT VACUUM!"	continuous	on	Vacuum levels in BOTH circuits are insufficient for lifting. Keep everyone away from suspended load until it can be safely lowered to a stable support. Service is required.	Find leak(s) in both vacuum circuits and replace parts as needed. Do not place lifter back into service until problem is resolved.
V081 V082 V083 V084	"Sensor # error, (low)" (# indicates relevant vacuum circuit)	continuous in "attach" mode; 1 chirp every minute in "Power Save" mode	(none)	<u>Vacuum sensor</u> malfunction in vacuum circuit indicated. Make sure sensor connector is attached correctly.	Check wiring and connector for <u>vacuum sensor</u> . Temporarily switch sensor connectors to determine whether to replace <u>Intelli-Grip® control unit</u> or manifold assembly (including sensors).
V091 V092 V093 V094	"Sensor # error, (high)" (# indicates relevant vacuum circuit)	continuous in "attach" mode; 1 chirp every minute in "Power Save" mode	(none)	<u>Vacuum sensor</u> malfunction in vacuum circuit indicated. Make sure sensor connector is attached correctly.	Check wiring and connector for <u>vacuum sensor</u> . Temporarily switch sensor connectors to determine whether to replace <u>Intelli-Grip® control unit</u> or manifold assembly (including sensors).

INTELLI-GRIP® OPERATOR MENUS

The Intelli-Grip® Control Unit features several menus that allow the operator to view more detailed information on the LCD screen and change various settings.

To ACCESS AND NAVIGATE THE OPERATOR MENUS

To access the main Operator Menu, hold the “function” button (Fn) for 5 seconds.

Note: Some operator menus can only be accessed when the lifter is in “Power Save” mode.



To scroll down, press the “release” button (↵).



To scroll up, press the “attach” button (⏏).



To select an item, press the “function” button (Fn).

When you are finished, scroll to **“Exit Menu”** and press the “function” button (Fn).

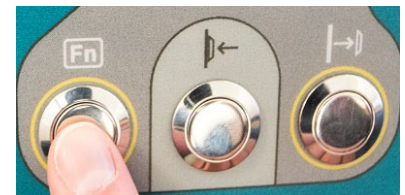

To exit all menus, press the “power” button (⏻).

Note: A similar process is used to navigate all operator menus.



INTELLI-GRIP® OPERATOR MENUS

TO CHANGE THE SCREEN LANGUAGE

- 1) Access the Operator Menu and select **“Language (ABC)”**, as previously directed.
- 2) In the Language (ABC) menu, select your preferred language or **“More options”** to see additional choices.

*Note: If you select **“Graphics only”**, no words of any language are displayed on the LCD screen during typical operation, but English is displayed in the menus.*

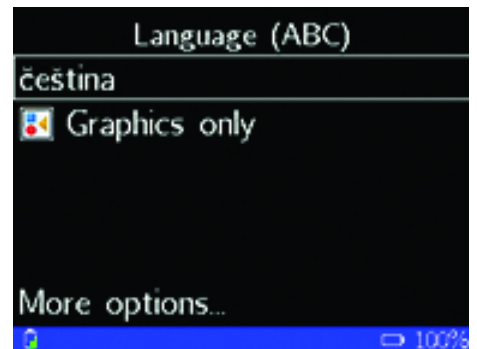
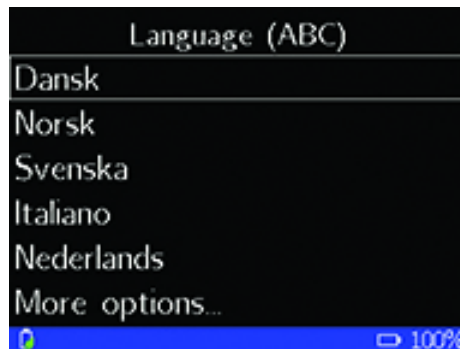

TO USE THE LIFTER AT HIGH ELEVATION

Using the lifter at high elevation may prevent the vacuum generating system from attaining the minimum vacuum level for lifting (see Operating Elevation under “SPECIFICATIONS” in lifter's *OPERATING INSTRUCTIONS*).

- 1) Access the Operator Menu and select **“Lifter Settings”**, as previously directed.
- 2) As indicated in the Lifter Settings menu, you must call Wood’s Powr-Grip to learn more about using the lifter at high elevation.

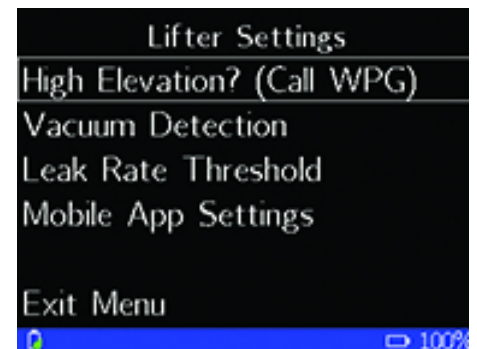

Note: The phone number is on the cover page of this SERVICE MANUAL.

INTELLI-GRIP® OPERATOR MENUS

TO CHANGE THE VACUUM DETECTION THRESHOLD

As a precaution, the lifter will activate the “attach” mode if vacuum is detected under unusual conditions (see Codes N00, N01 and N02 under “[INTELLI-GRIP® DIAGNOSTIC CODES](#)”). To adjust the sensitivity of this feature, follow these steps:



- 1) Access the Operator Menu and select “**Lifter Settings**”, as previously directed.
- 2) In the Lifter Settings menu, select “**Vacuum Detection**”.
- 3) In the Vacuum Detection Threshold menu, select the desired sensitivity threshold.

This setting can only be changed using this menu. It will **not** reset automatically when the lifter is powered down.

TO CHANGE THE LEAK RATE THRESHOLD

The lifter will alert the operator if vacuum decreases more quickly than expected (see Codes V011, V012, V013, V014 and V015 under “[INTELLI-GRIP® DIAGNOSTIC CODES](#)”). With rough or porous loads, this can result in frequent or constant alarms. To adjust the sensitivity of this feature, follow these steps:



- 1) Access the Operator Menu and select “**Lifter Settings**”, as previously directed.
- 2) In the Lifter Settings menu, select “**Leak Rate Threshold**”.

INTELLI-GRIP® OPERATOR MENUS

- 3) In the Leak Rate Threshold menu, select the desired sensitivity threshold or disable the alarm.

This setting can only be changed using this menu. It will **not** reset automatically when the lifter is powered down.

TO CHANGE MOBILE APP SETTINGS

To make use of WPG's Mobile App, you must enable communication from the lifter to your mobile device, as follows:

- 1) Access the Operator Menu and select **“Lifter Settings”**, as previously directed.
- 2) In the Lifter Settings menu, select **“Mobile App Settings”**.
- 3) In the Mobile App Settings menu, select **“Communication enabled”** to enable communication (**“ON”**).
Select **“Communication enabled”** again to disable communication (**“OFF”**).



Then press the “power” button (⏻) to complete the change.

Note: If the mobile app notifies you that a firmware update is available, tap the notification and follow the in-app instructions to update the lifter software.

INTELLI-GRIP® OPERATOR MENUS

To View System Information

The lifter keeps a record of the following information:

- Total hours of lifter operation (“Hour Meter”).
- Total number of lifting cycles completed (“Lift Counter”).
- Present voltage of the 12-volt battery (“Battery Voltage”).

To review this information, follow these steps:

- 1) Access the Operator Menu and select **“System Information”**, as previously directed.
- 2) In the System Information menu, find the desired information.



BATTERY CHARGER TEST

The battery charger should function as described in “MAINTENANCE: 12-VOLT BATTERY RECHARGE” in the lifter's *OPERATING INSTRUCTIONS*. If not, the following test allows you to determine whether to replace the charger. Perform this test **only** when the battery is **not** fully charged (see “OPERATION: BEFORE USING THE LIFTER: Checking the 12-Volt Battery” in *OPERATING INSTRUCTIONS*).

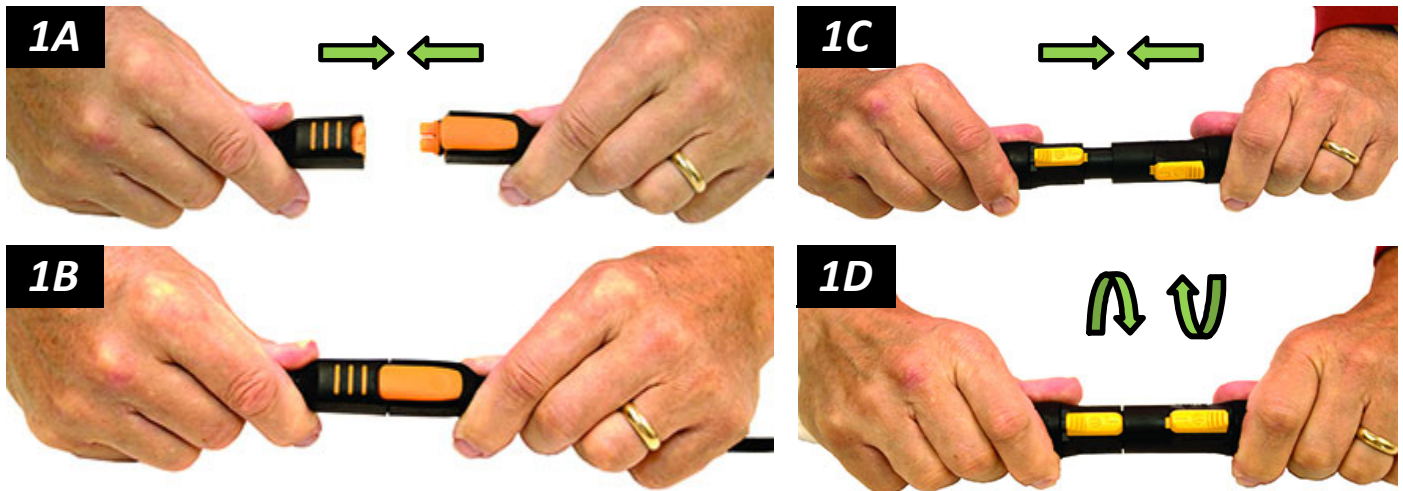

- 1) If electrical connectors for the battery or charger were previously disconnected, reconnect them (figs. 1A-B and figs. 1C-D).
- 2) Make sure the battery charger is **not** plugged into an AC power source. Then access the “Battery Voltage” reading on the LCD screen as previously directed (see “[TO VIEW SYSTEM INFORMATION](#)”).¹
- 3) Now plug the battery charger into an appropriate AC power source, as directed in the lifter’s *OPERATING INSTRUCTIONS*. If the charger is functioning correctly, the voltage reading on the LCD screen should begin to increase when the charger is plugged in. If the charger is **not** functioning correctly, replace it and repeat the test (see “[REPLACEMENT PARTS](#)”).



1..... If the battery is completely discharged, the LCD screen will not display anything. In this case, a voltmeter may be used to determine battery voltage in this test.

SERVICE PROCEDURES

AIR FILTER MAINTENANCE – 0.1 OZ BOWL SIZE



Inspect each air filter regularly, and service when necessary.

Immediately remove liquid found in the filter bowl, to prevent contact with the filter element (see below).



Never use bowl drain (circled in fig. 1A) to remove liquid, because this could cause air leak.

Replace the filter element whenever:

- It has an overall dirty appearance.
- There is a noticeable increase in the time required to attain full vacuum.

Filter Service Procedure

- 1) Unscrew the bowl from the body of the air filter (fig. 1B). Make sure the bowl seal is not damaged.
- 2) Unscrew the cap (fig. 2B) that secures the filter element.
- 3) Remove the filter element (fig. 3B). Use an air hose or other suitable means to remove any liquid or other contaminants found inside the bowl and body of the filter.
- 4) Determine whether the filter element (**#16102AM**) needs to be replaced (see above).

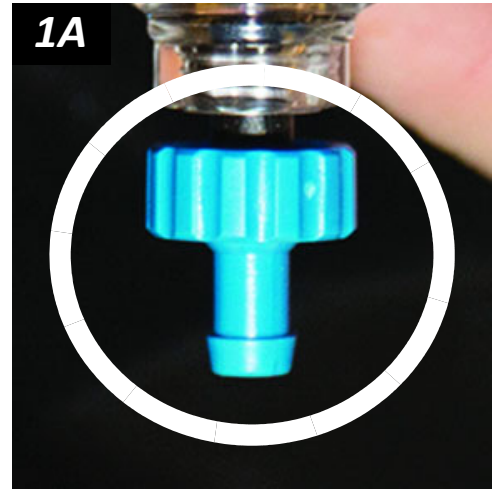

SERVICE PROCEDURES

5) Reassemble the air filter:

- 5.1) Slide the filter element over the center screw.
- 5.2) Reinstall the cap to secure the filter element in place.
- 5.3) Screw the bowl back into the filter body.
- 5.4) Make sure the bowl drain (circled in fig. 5B) is tightened securely (pull and twist clockwise).

6) Perform the “Vacuum Test” to be certain the air filter does not leak (see “INSPECTIONS AND TESTS: TESTING” in lifter's OPERATING INSTRUCTIONS).

Note: Repeat this procedure for any other filter of the same type.



SERVICE PROCEDURES

VACUUM PUMP MAINTENANCE – MODEL 1034204



Disconnect power source before proceeding.



If the vacuum pump takes too long to attain full vacuum, it may require maintenance. Replace the diaphragm or the head assemblies as necessary to obtain acceptable pump performance (see “[REPLACEMENT PARTS](#)”). Perform the following maintenance on both heads of the pump.

Caution: Do not overtighten head screws, because this may damage the threads in the pump body.

Replacing the Diaphragm

- 1) Remove the four head screws (item 1 in fig. 1A) and lock washers (item 2), and remove the head assembly (item 3).
- 2) Remove the diaphragm retaining screw (item 4), diaphragm (item 5), rubber O-ring (item 6) and flat washer (item 7). Be sure to note the diaphragm orientation for reassembly.
- 3) Replace the flat washer, rubber O-ring, diaphragm and diaphragm retaining screw.
- 4) Reverse the steps above to reassemble.

1A

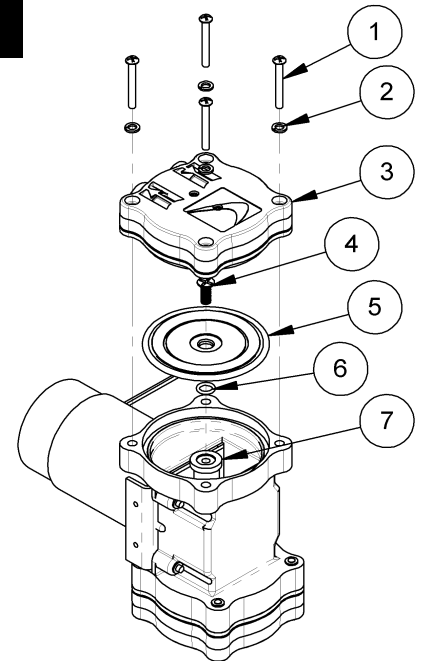

Replacing the Head Assembly¹

- 1) Remove the hose fittings from the head assembly, and carefully clean the threads. Be sure to note the fitting locations for reassembly.
- 2) Remove the four head screws (item 1 in fig. 1A), lock washers (item 2) and head assembly (item 3).
- 3) Replace the head assembly (reverse *step 2*).
- 4) Reinstall the hose fittings, using an appropriate thread sealant.

- 1 HEAD SCREW
- 2 LOCK WASHER
- 3 HEAD ASSEMBLY (#66197AA)
- 4 DIAPHRAGM RETAINING SCREW
- 5 DIAPHRAGM (#66197AM)
- 6 RUBBER O-RING
- 7 FLAT WASHER

1..... **Caution:** Depending on the product, the head assembly (item 3 in fig. 1A) may be rotated to an orientation different from the one shown. When removing the head assembly, always take note of its orientation and install it the same way during reassembly.

REPLACEMENT PARTS

Stock No.	Description	Qty.
66197AM	Pump Diaphragm Kit	2 / 4
66197AA	Pump Dual-Head Assembly	2 / 4
66136	Vacuum Pump– Diaphragm Type – 2.5 SCFM – 12 V DC	1
65211	Check Valve – 1/8 NPT	2
64834	LED Indicator – 12 V DC – Green (aka, vacuum lift light)	1
64752A	Audio Alarm – 5-15 V DC – Panel Mount	1
64716	Battery Charger – 0.8 Amp – 240 V AC – Australian Type	1
64715	Battery Charger – 0.8 Amp – 240 V AC	1
64714	Battery Charger – 0.8 Amp – 100 / 120 V AC	1
64713	Battery Charger – 7 Amp – 220 / 240 V AC – Australian Type (for MRTALP4/8-DC3)	1
64712	Battery Charger – 7 Amp – 100 / 115 V AC (for MRTALP4/8-DC3)	1
64711	Battery Charger – 7 Amp – 220 / 240 V AC (for MRTALP4/8-DC3)	1
64665	Battery – 12 V DC – 18 Amp-Hours	1
64664	Battery – 12 V DC – 7 Amp-Hours	1
64460	Circuit Breaker – 15 A	1
65254MM	Solenoid Valve – 12 V DC – 4 W	2
59916BN	14-Pin Cord Assembly – Long (for MRT4-DC3, MRTA8-DC3 & MRTALP4/8-DC3)	1
59916BM	14-Pin Cord Assembly – Short (for MRTALPCH6-DC3 & P1-DC3)	1
59908BB	Filter & Valve Manifold Assembly (including vacuum sensors) (for MRTALPCH6-DC3 & P1-DC3)	1
59908AB	Filter & Valve Manifold Assembly (including vacuum sensors) (for MRT4-DC3, MRTA8-DC3 & MRTALP4/8-DC3)	1
59906DM	Remote Control System Retrofit Kit (for MRTALPCH6-DC3)	1
59906	Remote Control System Retrofit Kit (for other models)	1
59901CB	Intelli-Grip® Control Unit (for P1-DC3 & MRTALPCH6-DC3)	1
59901AB	Intelli-Grip® Control Unit (for other models)	1
59900SB	Strobe Light – 12 V DC – Amber (for other models)	1
59900BB	Battery Holder – 9 V DC (for notification buzzer)	1
59086NC	Battery Connector – Twin Lead	1
54390NC	Power Lead – approx 21" Long (for P1-DC3)	1
54384NC	Power Lead – approx 51" Long (for MRTALP4/8-DC3)	1
54382NC	Power Lead – approx 35" Long (for MRT4-DC3, MRTA8-DC3 & MRTALPCH6-DC3)	1
16102AM	Element for Air Filter – 0.1 oz Bowl Size	2
15921AM	Vacuum Gauge – 1/8 NPT – CBM Type – w/Panel Mount Bracket – 18" Hg [-60 kPa] (for MRTALPCH6-DC3)	2
15920	Vacuum Gauge – 1/8 NPT – CBM Type – w/Panel Mount Bracket – 16" Hg [-54 kPa] (for other models)	2

See lifter's **OPERATING INSTRUCTIONS** for additional parts.

**SERVICE ONLY WITH IDENTICAL REPLACEMENT PARTS,
AVAILABLE AT WPG.COM OR THROUGH AN AUTHORIZED WPG DEALER**

COPYRIGHT NOTICE

Portions of the source code for this product require reproduction of a copyright notice or a permission notice in the distribution. These notices are included below:

Software Name: Tiva Peripheral Driver Library

License Type: BSD-3-Clause

Copyright © 1998 Todd C. Miller <Todd.Miller@courtesan.com>

All rights reserved.

Redistribution and use in source and binary forms, with or without modification, are permitted provided that the following conditions are met:

- 1) Redistributions of source code must retain the above copyright notice, this list of conditions and the following disclaimer.
- 2) Redistributions in binary form must reproduce the above copyright notice, this list of conditions and the following disclaimer in the documentation and/or other materials provided with the distribution.
- 3) The name of the author may not be used to endorse or promote products derived from this software without specific prior written permission.

THIS SOFTWARE IS PROVIDED "AS IS" AND ANY EXPRESS OR IMPLIED WARRANTIES, INCLUDING, BUT NOT LIMITED TO, THE IMPLIED WARRANTIES OF MERCHANTABILITY AND FITNESS FOR A PARTICULAR PURPOSE ARE DISCLAIMED. IN NO EVENT SHALL THE AUTHOR BE LIABLE FOR ANY DIRECT, INDIRECT, INCIDENTAL, SPECIAL, EXEMPLARY, OR CONSEQUENTIAL DAMAGES (INCLUDING, BUT NOT LIMITED TO, PROCUREMENT OF SUBSTITUTE GOODS OR SERVICES; LOSS OF USE, DATA, OR PROFITS; OR BUSINESS INTERRUPTION) HOWEVER CAUSED AND ON ANY THEORY OF LIABILITY, WHETHER IN CONTRACT, STRICT LIABILITY, OR TORT (INCLUDING NEGLIGENCE OR OTHERWISE) ARISING IN ANY WAY OUT OF THE USE OF THIS SOFTWARE, EVEN IF ADVISED OF THE POSSIBILITY OF SUCH DAMAGE.