

KEEP FOR FUTURE REFERENCE

# OPERATING INSTRUCTIONS



908 W. Main • P.O. Box 368  
Laurel, MT USA 59044  
800-548-7341 (phone)  
406-628-8231 (phone)  
406-628-8354 (fax)  
[www.WPG.com](http://www.WPG.com)

 **INTENDED FOR USE BY SKILLED  
PROFESSIONALS • READ AND  
UNDERSTAND BEFORE OPERATING**



**SINGLE-CHANNEL  
LIFTER, DC-VOLTAGE,  
WITH INTELLI-GRIP®  
TECHNOLOGY**

(Available with REMOTE CONTROL SYSTEM)

Model numbers: P110T04DC3 (shown),  
P110C04DC3, P11104DC3

  
Record serial number in blank space above (to locate, see serial  
label on the product).









# TABLE OF CONTENTS

<b>SPECIFICATIONS</b> .....	<b>3</b>
<b>SAFETY</b> .....	<b>5</b>
<b>OPERATING FEATURES</b> .....	<b>6</b>
<b>ASSEMBLY</b> .....	<b>7</b>
<b>INTENDED USE</b> .....	<b>9</b>
LOAD CHARACTERISTICS.....	9
OPERATING ENVIRONMENT .....	10
DISPOSAL OF THE LIFTER .....	10
<b>OPERATION</b> .....	<b>11</b>
<b>BEFORE USING THE LIFTER</b> .....	<b>11</b>
Taking Safety Precautions .....	11
Selecting a Screen Language .....	11
Performing Inspections and Tests .....	12
Checking the 12-Volt Battery .....	12
Preparing to Use the Remote Control System .....	13
<b>TO ATTACH THE PADS TO A LOAD</b> .....	<b>14</b>
Positioning the Lifter on the Load.....	14
Powering up the Lifter .....	15
Sealing the Pads on the Load .....	15
Reading the Vacuum Gauges .....	16
<b>TO LIFT AND MOVE THE LOAD</b> .....	<b>17</b>
Interpreting the Lift Light.....	17
Monitoring Vacuum Indicators .....	17
Controlling the Lifter and Load .....	18
In Case of a Power Failure.....	18
<b>TO ROTATE THE LOAD</b> .....	<b>19</b>
<b>TO TILT THE LOAD</b> .....	<b>20</b>
<b>TO RELEASE THE PADS FROM THE LOAD</b> .....	<b>21</b>
<b>AFTER USING THE LIFTER</b> .....	<b>22</b>
Storing the Lifter .....	23
Transporting the Lifter .....	23
<b>INSPECTIONS AND TESTS</b> .....	<b>24</b>
<b>INSPECTION SCHEDULE</b> .....	<b>24</b>

# TABLE OF CONTENTS

TESTING .....	25
Lifter/Load Compatibility Test.....	25
Operational Tests .....	26
Vacuum Test.....	26
Rated Load Test.....	27
Remote Control System Test .....	27
<b>MAINTENANCE .....</b>	<b>28</b>
<b>VACUUM PAD MAINTENANCE.....</b>	<b>28</b>
Pad-to-Load Friction Coefficient .....	28
Pad Inspection .....	28
Pad Cleaning .....	29
<b>TO REPLACE SEALING RING IN VPFS10T PADS .....</b>	<b>30</b>
<b>12-VOLT BATTERY RECHARGE.....</b>	<b>31</b>
<b>NOTIFICATION BUZZER BATTERY REPLACEMENT .....</b>	<b>32</b>
<b>INTELLI-GRIP® DIAGNOSTIC CODES .....</b>	<b>33</b>
<b>REPLACEMENT PARTS.....</b>	<b>37</b>
<b>LIMITED WARRANTY .....</b>	<b>38</b>
<b>TO OBTAIN REPAIRS OR WARRANTY SERVICE.....</b>	<b>38</b>

# SPECIFICATIONS

<b>Product Description</b>	Designed for use with hoisting equipment, P1-04DC3 lifters support loads using vacuum and manipulate loads using 180° rotation and manual 90° tilt motions.		
<b>Model Number</b>	P110C04DC3	P110T04DC3	P11104DC3
<b>Vacuum Pads<sup>1</sup></b> (4 each, standard rubber)	10" [25 cm] nom. diameter, concave (Model G0750)	10" [25 cm] nom. diameter, with replaceable ring <sup>2</sup> (Model VPFS10T)	11" [28 cm] nom. diameter, lipped (Model G3370)
<b>Pad Spread</b> (to outer edges)	49" x 10" [125 cm x 25 cm]	50¾" x 11¾" [129 cm x 30 cm]	51" x 12" [130 cm x 30 cm]
 <b>Maximum Load Capacity<sup>3</sup></b>	Per pad: 150 lbs [68 kg] Total: 600 lbs [270 kg]	Per pad: 150 lbs [68 kg] Total: 600 lbs [270 kg]	Per pad: 175 lbs [80 kg] Total: 700 lbs [320 kg]
 <b>Lifter Weight</b>	95 lbs [44 kg]		
<b>Power System</b>	12 volts DC, 5.5 amps		
<b>Battery Capacity</b>	7 amp-hours		
 <b>Rotation Capability</b>	Manual, 180°, with latching at each ¼ turn (when required)		
 <b>Tilt Capability</b>	Manual, 90°, with automatic latching in vertical position		
 <b>Product Options</b>	<i>Available with Remote Control System – FCC, CE and ICC certified.</i>		
 <b>Operating Elevation</b>	Up to 6,000' [1,828 m]		
 <b>Operating Temperature</b>	32° — 104° F [0° to 40° C]		
<b>Service Life</b>	20,000 lifting cycles, when used and maintained as intended <sup>4</sup>		
<b>Software Version</b>	Intelli-Grip <sup>®</sup> 7.6		
<b>ASME Standard BTH-1</b>	Design Category "B", Service Class "0"		
<b>Troubleshooting Guide<sup>5</sup></b>	<a href="#">TST-021_DC3_REV_2018-023</a>		

- 1..... Available with other rubber compounds for special purposes (see [www.wpg.com](http://www.wpg.com)).
- 2..... Standard with replaceable sealing ring for rough or textured surfaces (see "REPLACEMENT PARTS").
- 3..... The Maximum Load Capacity is rated at a vacuum of 16" Hg [-54 kPa] on clean, smooth, nonporous flat surfaces with a friction coefficient of 1. Pad compound, load rigidity, strength, surface conditions, overhang, angle, center of gravity and temperature can also affect the lifting capacity. A "qualified person" should evaluate the effective lifting capacity for each use (see definition under "Rated Load Test").
- 4..... Vacuum pads, filter elements and other wear-out items are excluded.
- 5..... To view this guide, click the link at right. Additionally, you can search for your lifter's Model Number at [www.wpg.com](http://www.wpg.com) and select the "Troubleshooting" link on the product page.

# SPECIFICATIONS

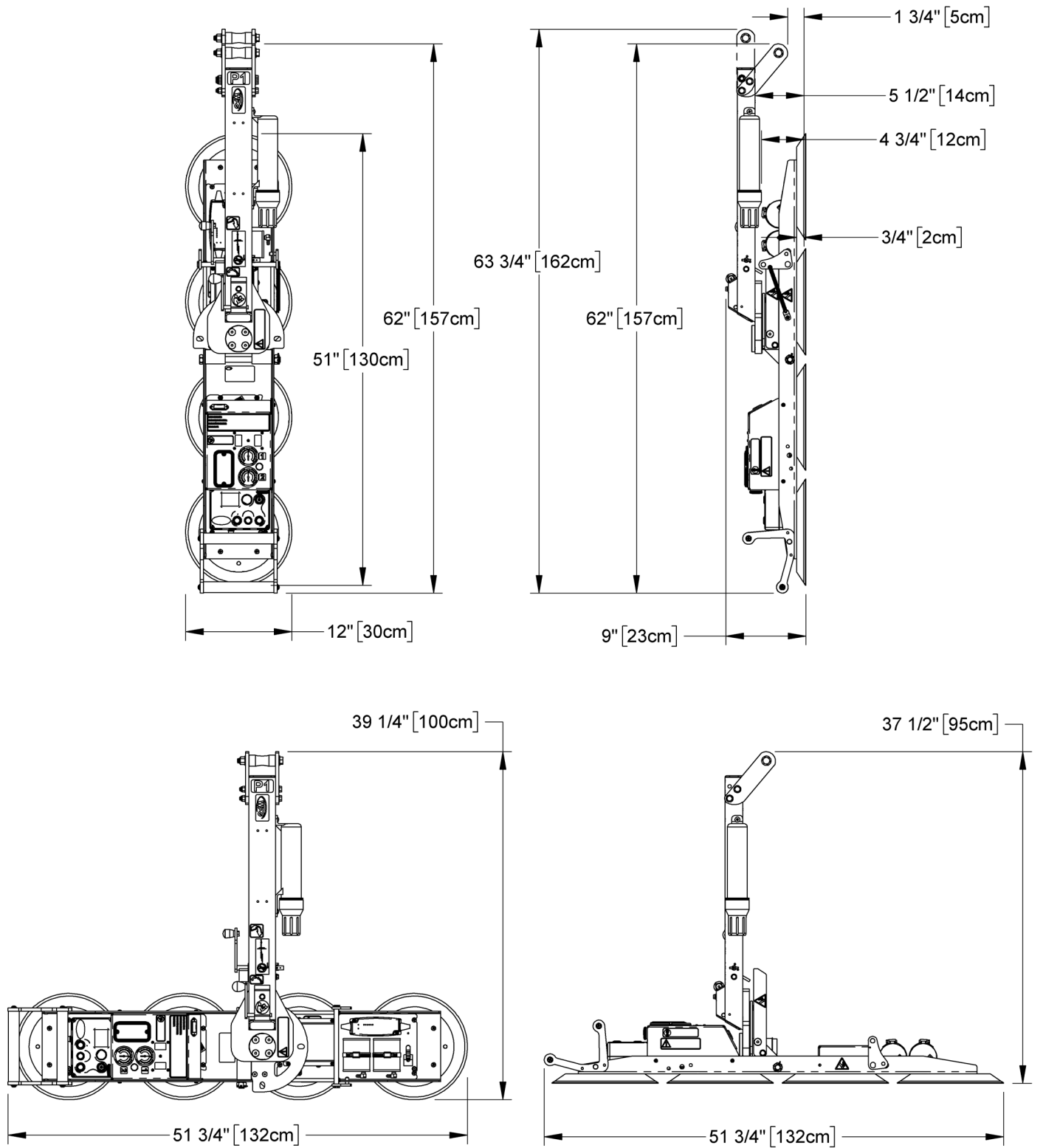

Note: A standard P11104DC3 is shown.

# SAFETY



Wear personal protective equipment that is appropriate for the load material. Follow trade association guidelines.



Do not remove or obscure safety labels.



Do not make any modifications to the lifter (see “LIMITED WARRANTY”).



Use the lifter only in an approved “OPERATING ENVIRONMENT” (see “INTENDED USE”).



Do not use a lifter that is damaged, malfunctioning, or missing parts.



Do not use a lifter if the sealing edge of any vacuum pad is cut or otherwise damaged.



Do not use a lifter to lift cracked or broken glass.



Do not exceed the Maximum Load Capacity or lift loads the lifter is not designed for (see “INTENDED USE”).



Do not use a lifter if the Maximum Load Capacity or any safety label appears to be missing or obscured.



Make sure the contact surfaces of the load and vacuum pads are clean before attaching the lifter (see “MAINTENANCE”).



Position the vacuum pads correctly on the load before lifting (see “OPERATION: Positioning the Lifter on the Load”).



Do not lift a load if any vacuum indicator shows inadequate vacuum.



Keep unauthorized personnel away from the lifter, to avoid injury in case of an unintended load release.



Do not touch the vacuum release controls during a lift.



Do not allow people to ride on the lifter or the load.



Do not lift a load higher than necessary or leave suspended loads unattended.



Do not position a loaded or unloaded lifter over people.



Before servicing a powered lifter, place the power control in the inactive position and, when possible, disconnect the power source.

# OPERATING FEATURES

Features shown here are underlined> on their first appearance in each section following.

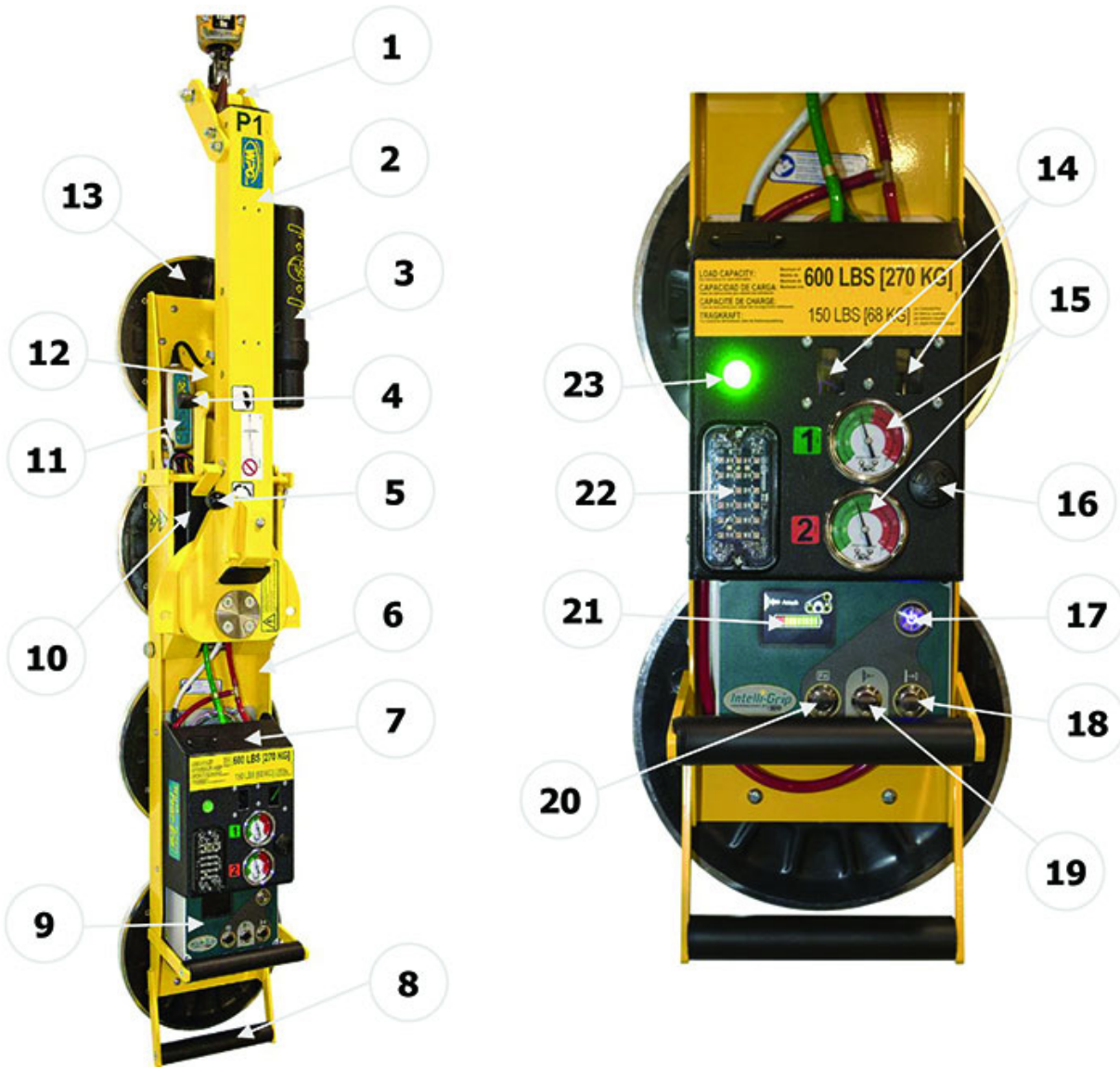

- |   |                            |                                |
|---|----------------------------|--------------------------------|
| 1 LIFT POINT  | 2 LIFT BAR                 | 3 INSTRUCTIONS CANISTER        |
| 4 TILT RELEASE LEVER                                    | 5 ROTATION RELEASE LEVER   | 6 PAD FRAME                    |
| 7 Cover for VACUUM PUMP, AIR FILTERS and VACUUM SENSORS | 8 CONTROL HANDLE           | 9 INTELLI-GRIP® CONTROL UNIT   |
| 10 BATTERY  | 11 BATTERY CHARGER         | 12 VACUUM RESERVE TANK         |
| 13 VACUUM PAD   | 14 Windows for AIR FILTERS | 15 VACUUM GAUGES               |
| 16 NOTIFICATION BUZZER                                  | 17 POWER BUTTON            | 18 "RELEASE" BUTTON            |
| 19 "ATTACH" BUTTON                                      | 20 "FUNCTION" BUTTON       | 21 LCD SCREEN w/ BATTERY GAUGE |
| 22 WSTROBE LIGHT  | 23 VACUUM LIFT LIGHT       |                                |

*Note: A standard P110T04DC3 is shown. Although some of the following photos do not show this specific lifter, they all illustrate how this kind of lifter functions.*

For information about specific parts, see ["REPLACEMENT PARTS"](#) and/or any separate instructions for Product Options.



# ASSEMBLY

1) Remove all shipping materials and save them with the shipping container for future use.

2) Adjust the lift point to optimize the lifter's hang angle:

2A



2.1) Remove the retaining bolt and loosen the pivot bolt (fig. 2A).

2.2) Move the lift point to the appropriate position.<sup>1</sup>

2.3) Reinstall the retaining bolt and tighten both bolts securely.

3) Suspend the lifter from appropriate hoisting equipment:

3.1) Select a crane and/or hoist rated for the Maximum Load Capacity plus the Lifter Weight.

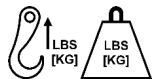

*Note: Any lifter use must comply with all statutory or regulatory standards for hoisting equipment in your region.*

3A



3B



3C



3.2) Disengage the tilt latch and raise the lift bar (fig. 3A-C).

1..... Moving the lift point *forward* (away from operator) helps keep the hang angle vertical while the lifter is *loaded*; moving the lift point *rearward* (towards operator) helps keep the hang angle vertical while the lifter is *unloaded*.

# ASSEMBLY

3.3) Attach the hoisting hook to the lift point (fig. 3D).

Use rigging (fig. 3E) as needed to make sure the hook does not interfere with the load.



**!** Only use rigging rated for Maximum Load Capacity plus Lifter Weight.

3.4) Use the hoisting equipment to remove the lifter from the shipping container. Avoid damaging the vacuum pads.



4) Connect the electrical connectors (figs. 4A-B and figs. 4C-D).

Install the 9-volt battery for the notification buzzer as directed in "NOTIFICATION BUZZER BATTERY REPLACEMENT".

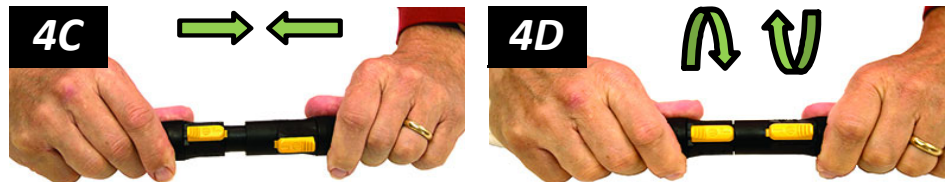

5) Remove the pad covers (fig. 5A) and save them for future use.

6) Perform tests as required under "TESTING".



# INTENDED USE

## LOAD CHARACTERISTICS

Make sure the vacuum lifter is intended to handle each load according to these requirements:



**Do NOT lift explosives, radioactive substances or other hazardous materials.**



- The load weight must not exceed the Maximum Load Capacity.
- The load must be a single piece of relatively nonporous material with a flat and relatively smooth contact surface.<sup>1, 2</sup> To determine whether the load is too porous or rough, perform the “[Lifter/Load Compatibility Test](#)”.
- The load's contact surface must be able to obtain a friction coefficient of 1 with the lifter's vacuum pads (see “[Pad-to-Load Friction Coefficient](#)”). Otherwise, the capacity should be derated appropriately.
- The load's surface temperature must not exceed the Operating Temperatures.<sup>3</sup>
- The load's *minimum* length and width are determined by the current Pad Spread (see “SPECIFICATIONS”).
- The load's *maximum* length and width are determined by its allowable overhang.<sup>4</sup>
- 1" [2.5 cm] is the allowable thickness at Maximum Load Capacity.<sup>5</sup>



*Note: Standard vacuum pads can stain or deform load surfaces with light colors or soft coatings. Test such surfaces for damaging effects before using the lifter on them.<sup>6</sup>*

1..... Although concave vacuum pads can also attach to some curved loads, curvature can reduce lifting capacity. Contact WPG for more information.

2..... A “single piece” of material includes curtainwall assemblies, unitized glazing systems and similar construction units.

3..... Vacuum pads made from a heat-resistant rubber compound can enable you to lift loads with higher surface temperatures. Contact WPG or an authorized dealer for more information.

4..... The allowable overhang is the amount of load material that can extend sideways beyond the vacuum pads without breaking or otherwise being damaged. This depends on the load material, its thickness, and the angle of handling (if any). Since every material has different physical properties, the allowable overhang must be evaluated separately for each load type. Contact WPG or an authorized dealer for more information.

5..... However, the allowable thickness increases as load weight decreases. Contact WPG for more information.

6..... Alternative rubber compounds are available for these purposes. Contact WPG or an authorized dealer for more information.

# INTENDED USE

## OPERATING ENVIRONMENT

Make sure the vacuum lifter is intended for use in each work environment, given the following restrictions:

- This lifter is not intended for any environment that is dangerous to the operator or damaging to the lifter. Avoid environments containing explosives, caustic chemicals and other dangerous substances.

 **Never use lifter in dangerous environments.**



**Metal particles and similar environmental contaminants could result in vacuum pump failure.**

- The work environment is limited by the Operating Elevation and Operating Temperatures.<sup>1, 2</sup>
- The lifter is not designed to be watertight. Do not use it in rain or other unsuitable conditions.

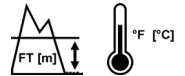

**Moisture can result in reduced lifting capacity.**

## DISPOSAL OF THE LIFTER

After the Service Life of the vacuum lifter has ended (see “SPECIFICATIONS”), dispose of it in compliance with all local codes and applicable regulatory standards.

*Note: Special disposal regulations may apply to the battery.*

1..... Although lifter use may be possible at higher elevation, lifting capacity is reduced whenever the lifter is unable to attain vacuum in the green range on the vacuum gauge. Contact WPG for more information.

2..... Special provisions may allow the lifter to operate outside the specified temperature range. Contact WPG for more information.

# OPERATION

## BEFORE USING THE LIFTER

Determine whether the vacuum lifter is capable of each intended task (see “SPECIFICATIONS” and “[INTENDED USE](#)”). Then complete the following preparations:

### Taking Safety Precautions

- Be trained in all industry and regulatory standards for lifter operation in your region.
- Follow trade association guidelines about precautions needed for each load material.



**Read all directions and safety rules before using lifter.**



**Always wear appropriate personal protective equipment.**

### Selecting a Screen Language

When the lifter is powered up for the first time, the [Intelli-Grip® control unit](#) prompts the operator to select a language for the [LCD screen](#). Use the buttons as follows:



- To scroll down, press the “[release](#)” button (|→|).
- To scroll up, press the “[attach](#)” button (|←|).
- To select a language, press the “[function](#)” button (Fn).<sup>1</sup>



*Note: A similar process is used to navigate all menus.*

<sup>1</sup>..... To change the language again, refer to the “INTELLI-GRIP® OPERATOR MENUS” section of the [SERVICE MANUAL](#).

# OPERATION

## Performing Inspections and Tests

- Follow the “[INSPECTION SCHEDULE](#)” and “[TESTING](#)”.
- Service the 2 [air filters](#) whenever a bowl contains liquid or other contaminants, or an element appears dirty (see “[AIR FILTER MAINTENANCE](#)” in [SERVICE MANUAL](#)).
- Make sure the [notification buzzer](#) is clearly audible at the maximum distance between the operator and the lifter, despite any barriers or obstacles.<sup>1, 2</sup>



**Examine air filters regularly and service when needed.**



**Make sure notification buzzer can be heard over noise at operator position.**

## Checking the 12-Volt Battery



**Always check [battery energy](#) before every lift.**

While the lifter is powered up, a [battery gauge](#) on the [LCD screen](#) displays the current energy level.<sup>3, 4</sup>

- If battery energy is in the red range, discontinue lifter use and charge the battery (see “[12-VOLT BATTERY RECHARGE](#)”).
- If battery energy continues to decrease and you try to attach the lifter to a load, the [notification buzzer](#) will sound continuously and the LCD screen will display “Lockout (low 12V battery)”, along with a diagnostic code (see “[INTELLI-GRIP® DIAGNOSTIC CODES](#)”). In this case, you must charge the battery in order to continue using the lifter.

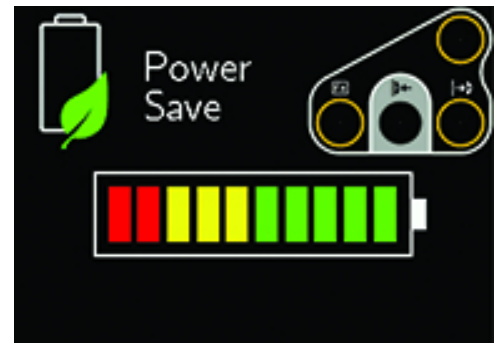

1..... Maximum buzzer volume is 95 dBA at 2' [60 cm]. If CE or UKCA Standards apply, consult EN 7731 to make sure the notification buzzer is compliant.

2..... The “[Vacuum Test](#)” provides a convenient opportunity to check this.

3..... If the lifter remains in “Power Save” mode for a long time, the pump will run periodically to test the battery.

4..... If the battery charger is connected to an AC power source, the reading on the battery gauge will not be accurate and “Replace 12V battery?” may appear on the LCD screen, because the system cannot accurately evaluate the battery.

# OPERATION

## Preparing to Use the Remote Control System

 The optional radio transmitter (fig. 1A) and radio receiver enable you to activate the lifter's "attach" and "release" functions at distances up to 250' [76 m], provided you have a clear and direct view of the lifter and its status indicators.

To operate a lifter remotely, follow these safety rules:

- Visually verify the status of the lifter and load prior to lifting.



***Make sure nearby personnel are aware of intended remote control actions.***

- Monitor the lifter at all times to make sure it is functioning as intended.<sup>1</sup>
- Be sure the load is lowered and supported correctly before releasing it (see following sections).

*Note: To prevent any radio transmission, press the emergency disconnect button.<sup>2</sup>*

**1A**



- 1 EMERGENCY DISCONNECT BUTTON
- 2 TRANSMISSION INDICATOR LIGHT
- 3 "RELEASE" BUTTON
- 4 "ATTACH" BUTTON
- 5 POWER/"FUNCTION" BUTTON

1..... The Remote Control System is designed to prevent multiple lifters from responding. Nevertheless, radio-controlled lifters should be tested to make sure each transmitter controls only one lifter.

2..... To reset the emergency disconnect button, twist the button clockwise and allow it to spring outward to its original position.

# OPERATION

## TO ATTACH THE PADS TO A LOAD

Make sure the contact surfaces of the load and vacuum pads are clean (see “[Pad Cleaning](#)”).



### Positioning the Lifter on the Load

- 1) Center the pad frame on the load.<sup>1</sup>
- 2) Make sure all vacuum pads will fit on the load and will be loaded evenly.  
 Consult the Per-Pad Load Capacity.
- 3) Place the vacuum pads in contact with the load surface.



1..... The lifter is designed to handle the maximum load weight when the load's center of gravity is positioned within 2" [5 cm] of the lifter's rotation axis. Uncentered loads may rotate or tilt unexpectedly.



# OPERATION

## Powering up the Lifter

Press the lifter's power button (⏻ — fig. 1A). The vacuum pump will run for a few seconds, as a normal function of the Intelli-Grip® self-diagnostics.

The lifter automatically tests the 9-volt battery for the notification buzzer each time the lifter is powered up. When this battery runs down, the LCD screen displays “Replace 9V battery?” and the buzzer chirps once per minute. Replace the battery as needed (see “[NOTIFICATION BUZZER BATTERY REPLACEMENT](#)”).



 To use the optional Remote Control System, briefly hold the power button (⏻ — fig. 1B) on the radio transmitter to activate it.<sup>1</sup>

*Note: When you hold any button on the transmitter, the transmission indicator light flashes green if the transmitter is activated.*



## Sealing the Pads on the Load

Press the lifter's “attach” button (⏪ — fig. 1C).

 **Keep “attach” function activated throughout lift.**



1..... The radio transmitter turns off automatically after a period of inactivity.

# OPERATION

 To use the optional Remote Control System, press the “attach” button (↵ ← — fig. 1D) on the radio transmitter.

**2B**



The vacuum pump will run until the vacuum pads seal completely. If the lifter takes too long to attach, the notification buzzer chirps and the LCD screen displays “Vacuum not increasing normally”, along with a diagnostic code (see [“INTELLI-GRIP® DIAGNOSTIC CODES”](#)). In this case, press the lifter firmly against the load to help the pads begin to seal.<sup>1</sup>

## Reading the Vacuum Gauges

The 2 vacuum gauges of the dual vacuum system show the current vacuum level in positive inches of Hg and negative kPa:

- **Green range** ( $\geq 16$ " Hg [-54 kPa]): Vacuum level is sufficient to lift the maximum load weight (fig. 1A).
- **Red range** ( $< 16$ " Hg [-54 kPa]): Vacuum level is **not** sufficient to lift the maximum load weight (fig. 1B).<sup>2</sup>

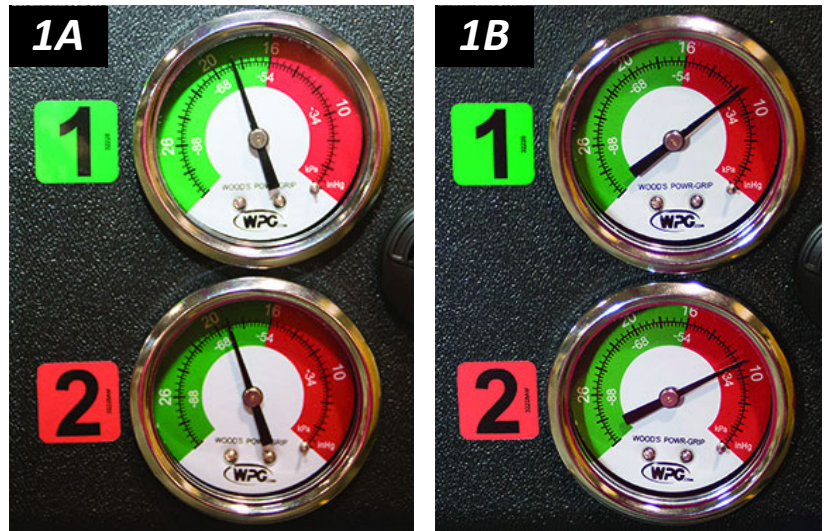

If it takes more than 5 seconds for the vacuum level to reach 5" Hg [-17 kPa] on either vacuum gauge, press on any vacuum pad that has not yet sealed.

Once the pads have sealed, the lifter should be able to maintain sufficient vacuum for lifting, except when used above the maximum Operating Elevation.<sup>3</sup> If it does not, perform the [“Vacuum Test”](#).

1..... Although a vacuum pad may become distorted during shipping or storage, this condition should correct itself with continued use.

2..... The gauge face colors do not correspond with the circuit colors.

3..... If the lifter is used above the maximum Operating Elevation (see [“SPECIFICATIONS”](#)), it may not be able to maintain sufficient vacuum for lifting. Contact WPG for more information.

# OPERATION

## To Lift and Move the Load



***Lift bar must be vertical to lift load.***

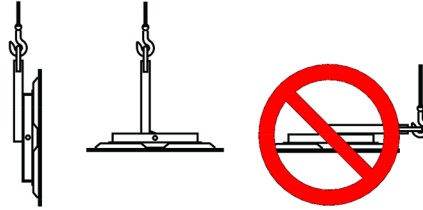

## Interpreting the Lift Light



When vacuum is sufficient to lift the Maximum Load Capacity, the vacuum lift light turns *on* automatically and the vacuum pump turns *off* temporarily, to conserve battery energy.



***Never lift load unless lift light is illuminated, because premature lifting could result in load release and personal injury.***

## Monitoring Vacuum Indicators

Monitor the vacuum lift light and both vacuum gauges throughout the entire lift (fig. 1A).



***Make sure all vacuum indicators remain completely visible.***

The vacuum pump turns on and off to overcome any leakage. However, if the leak rate is greater than normal, the notification buzzer chirps and the LCD screen displays the message “Vacuum decrease on circuit #”, along with a diagnostic code (see “[INTELLI-GRIP® DIAGNOSTIC CODES](#)”).<sup>1</sup> Such leaks can cause the battery to be discharged more quickly.

***If the vacuum pump is unable to overcome leakage***, the notification buzzer sounds continuously, the lift light turns off, and the LCD screen displays the message “INSUFFICIENT VACUUM!”, along with a diagnostic code (see “[INTELLI-GRIP® DIAGNOSTIC CODES](#)”). If this happens:

- 1) Keep everyone away from a suspended load until it can be safely lowered to a stable support.



***Stay clear of any suspended load while indicators warn of low vacuum.***



1..... Automatic leak detection is **not** a substitute for performing the “[Vacuum Test](#)”, required by the “[INSPECTION SCHEDULE](#)” and “[TESTING](#)”. Sensitivity of leak detection can be adjusted (see “[INTELLI-GRIP® OPERATOR MENUS](#)” in [SERVICE MANUAL](#)).

# OPERATION

- 2) Stop using the lifter until the cause of the vacuum loss can be identified: Conduct the “[Pad Inspection](#)” and perform the “[Vacuum Test](#)”.
- 3) Correct any faults before resuming normal operation of the lifter.

## Controlling the Lifter and Load

When the lifter is ready, use the hoisting equipment to raise the lifter and load as needed.

Use a control handle (circled in fig. 1A) to keep the lifter and load in the required position.

Once there is enough clearance, you may move the load as required.



## In Case of a Power Failure

In the event of a battery failure or electrical system failure, the notification buzzer will sound continuously.

Although the vacuum reserve tanks are designed to support the load for at least 5 minutes without power, this depends on many factors, including the “[LOAD CHARACTERISTICS](#)” and the condition of vacuum pads (see “[VACUUM PAD MAINTENANCE](#)”).

If a power failure occurs, keep everyone away from a suspended load until it can be lowered safely to a stable support. Correct any faults before resuming normal operation of the lifter.



***Stay clear of any suspended load during power failure.***

# OPERATION

## To ROTATE THE LOAD

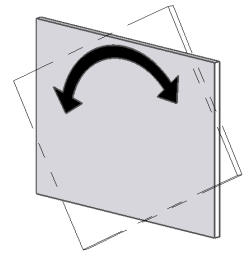

 **Make sure load is positioned correctly on lifter (as previously directed).**

 **Never disengage rotation and tilt latches at the same time, because this could result in load damage or personal injury.**

- 1) Make sure the load has enough clearance to rotate without contacting anyone or anything.
- 2) Use a control handle (circled in fig. 2A) to keep the load under control at all times.

 **Unbalanced loads may rotate unexpectedly when latch is disengaged.**

- 3) Pull the rotation release lever (fig. 3A) to disengage the rotation latch, and rotate the load as required.
- 4) To stop rotation, let go of the lever and guide the load to the next stop.

*Note: Whenever rotation is not required, keep the rotation latch engaged, to prevent load damage or personal injury.*



# OPERATION

## TO TILT THE LOAD



**Make sure load is positioned correctly on lifter (as previously directed).**



**Never disengage rotation and tilt latches at the same time, because this could result in load damage or personal injury.**

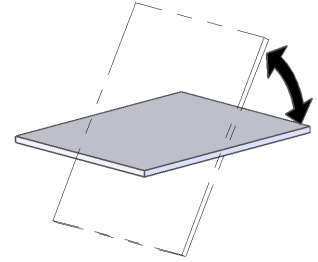

1) Make sure the load has enough clearance to tilt without contacting anyone or anything.

**2A**

2) Use a control handle (circled in fig. 2A) to keep the load under control at all times.



**Unbalanced loads may tilt unexpectedly when latch is disengaged.**

3) If the pad frame is latched, pull the tilt release lever (fig. 3A) to disengage the tilt latch. Then tilt the load as required.



*Note: See "LOAD CHARACTERISTICS" for information about allowable overhang.*

A load with overhang may force you to release the control handle as the load approaches the flat position. In this case, use a hand cup (circled in fig. 4A) or other appropriate means to control the load.

*Note: The pad frame automatically latches when tilted to the vertical position.*



**4A**

# OPERATION

## TO RELEASE THE PADS FROM THE LOAD



***Make sure load is at rest and fully supported before releasing vacuum pads.***

- 1) Hold the “function” button (Fn) — fig. 1A) and the “release” button (↵) — fig. 1A). If the vacuum seal does not break, follow the directions on the LCD screen.



- To use the optional Remote Control System, hold the “function” button (☞) — fig. 1B) and the “release” button (↵) — fig. 1B) on the radio transmitter.



*Note: The strobe light (fig. 1C) flashes while the “function” or “release” button is held, to show the operator that signals are being transmitted and to warn others that the operator may be releasing the load.*

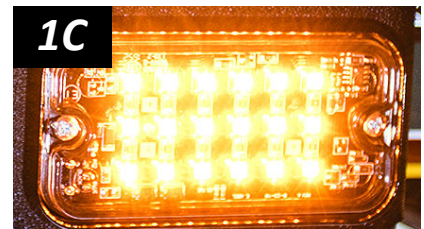

- 2) Continue to hold the “function” and “release” buttons until the vacuum pads release the load completely. Otherwise, the vacuum lifter will automatically revert to “attach” mode.<sup>1</sup>



***Do not move lifter until pads release completely, because such movement could result in load damage or personal injury.***



After the load is successfully released, the lifter activates the “Power Save” mode automatically.

- 3) Before you lift another load, perform the Every-Lift Inspection (see “[INSPECTION SCHEDULE](#)”).

1..... A “Timed Release” function can be used to help separate the lifter from the load: Hold the “function” and “release” buttons until a yellow arrow appears on the LCD screen. Then tap the “function” button 2 or more times. This prolongs the release mode for 5 seconds per each additional tap.

# OPERATION

## AFTER USING THE LIFTER

- 1) Press the power button ( , fig 1A) and the “function” button ( , fig. 1A) to power down the vacuum lifter.
- 2) Charge the battery after each workday as needed (see “[12-VOLT BATTERY RECHARGE](#)”).<sup>1</sup>
- 3) Use the hoisting equipment to lower the lifter gently onto a stable support. Then detach the hoisting hook from the lift point.



**Caution:** Do not set lifter on surfaces that could soil or damage vacuum pads. If the lifter has VPFS10T pads, protect their sealing rings by making sure each pad rests on spacers.<sup>2</sup>

**Note:** A control handle can be used to support an unloaded lifter when not suspended (fig. 3A). Make sure the lifter leans securely against an appropriate support that does not contact the vacuum pads.



1..... To maximize battery life, charge it promptly after each use.

2..... If the lifter has VPFS10T pads, cardboard spacers are integrated into the original shipping container. Similarly shaped spacers should be used when setting the lifter on other surfaces.



# OPERATION

## Storing the Lifter

- 1) Use the covers supplied to keep the vacuum pads clean (fig. 1A).



**CE/UKCA** -- To prevent the lifter from tipping over on relatively horizontal surfaces, place the vacuum pads facedown on a clean, smooth, flat surface. Then lower the lift bar and place a support under the lift point.

- 2) Charge the battery completely and repeat every 6 months (see “12-VOLT BATTERY RECHARGE”).

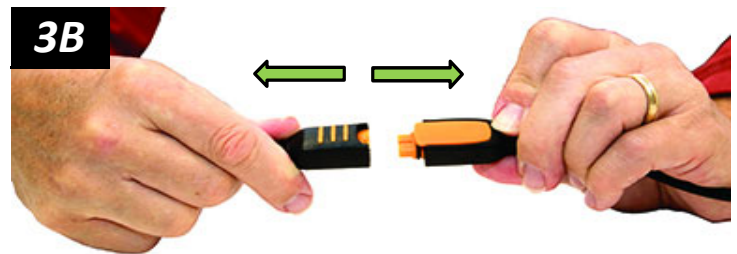

- 3) Disconnect the electrical connectors (figs. 3A-B and figs. 3C-E) to prevent battery discharge.

- 4) Store the lifter in a clean, dry location.

Store the battery between 32° and 70° F [0°–21° C]. Avoid storage above 100° F [38° C].

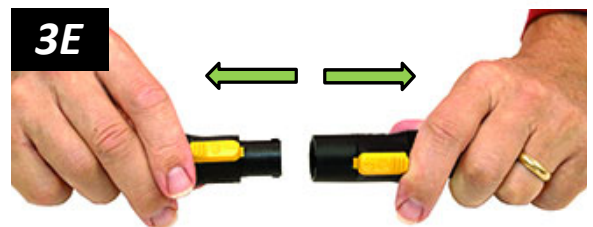
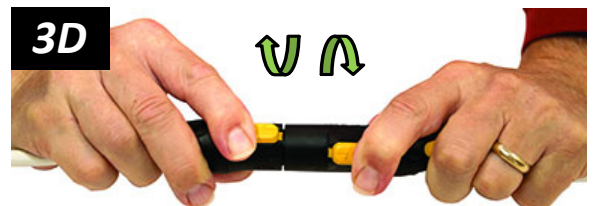
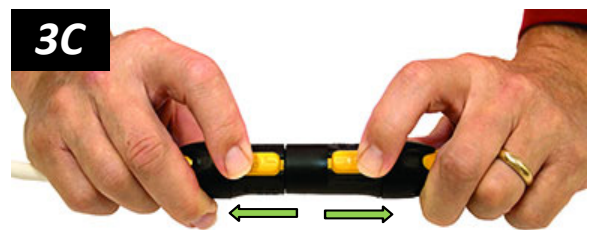

## Transporting the Lifter

Secure the lifter in the original shipping container with the original shipping materials or equivalent.

# INSPECTIONS AND TESTS

## INSPECTION SCHEDULE

Perform inspections according to the following frequency schedule. If any fault is found, correct it and perform the next most frequent inspection before using the vacuum lifter.

*Note: If a lifter is used less than 1 day in a 2-week period, perform the Periodic Inspection before using it.*

Action	Every Lift	Frequent <sup>1</sup> (Every 20-40 hrs.)	Periodic <sup>2</sup> (Every 250-400 hrs.)
Examine <u>vacuum pads</u> for contaminants or damage (see “ <a href="#">Pad Inspection</a> ”).	✓	✓	✓
Examine load surface for contaminants or debris.	✓	✓	✓
Examine controls and indicators for damage.	✓	✓	✓
Examine lifter’s structure for damage.		✓	✓
Examine vacuum system for damage (including <u>vacuum pads</u> , fittings and hoses).		✓	✓
Examine <u>air filters</u> for conditions requiring service (see “AIR FILTER MAINTENANCE” in <a href="#">SERVICE MANUAL</a> ).		✓	✓
Perform “ <a href="#">Vacuum Test</a> ”.		✓	✓
Check for unusual vibrations or noises while operating lifter.		✓	✓
 If the lifter has a Remote Control System, perform “ <a href="#">Remote Control System Test</a> ”.		✓	✓
Examine entire lifter for evidence of: <ul style="list-style-type: none"> <li>• looseness, excessive wear or excessive corrosion</li> <li>• deformation, cracks, dents to structural or functional components</li> <li>• cuts in vacuum pads or hoses</li> <li>• any other hazardous conditions</li> </ul>			✓
Inspect entire electrical system for damage, wear or contamination that could be hazardous, in compliance with all local codes and regulatory standards. <b>Caution:</b> Use appropriate cleaning methods for each electrical part, as specified by codes and standards. Improper cleaning can damage parts.			✓

1..... The Frequent Inspection is also required whenever the lifter has been out of service for 1 month or more.

2..... The Periodic Inspection is also required whenever the lifter has been out of service for 1 year or more. Keep a written record of all Periodic Inspections. If necessary, return the lifter to WPG or an authorized dealer for repair (see “[LIMITED WARRANTY](#)”).

## TESTING

Perform the following test to determine whether or not a load surface is too porous or rough:

### Lifter/Load Compatibility Test<sup>1</sup>

- 1) Make sure the vacuum generating system is functioning correctly (see “[Vacuum Test](#)”).
- 2) Thoroughly clean the load surface and the vacuum pads (see “[Pad Cleaning](#)”).<sup>2</sup>
- 3) Place the load in the position on a stable support.
- 4) Attach the vacuum pads to the load as previously directed.
- 5) After the vacuum pump stops running, hold the “function” button (Fn) and the “power” button (⏻) for at least 5 seconds to power down the vacuum lifter.

*Note: During this time the LCD screen displays “WARNING! Is load attached?”, the notification buzzer chirps rapidly and the strobe light flashes.*

- 6) Raise the load a minimal distance, to make sure it is supported by the lifter.
- 7) Watch each vacuum gauge: **Starting from a vacuum level of 16" Hg [-54 kPa], the lifter must maintain a vacuum level greater than 12" Hg [-41 kPa] for 5 minutes.**<sup>3</sup> If not, lifting this load requires additional precautions (eg, a load sling). Contact WPG for more information.
- 8) Lower the load *after* 5 minutes or *before* the vacuum level diminishes to 12" Hg [-41 kPa].



**Take precautions in case load should fall during test.**

1..... The “[Pad-to-Load Friction Coefficient](#)” can affect the outcome of this test.

2..... Contaminated loads can also cause the vacuum pump to run frequently or continuously. Since excessive pumping quickly reduces battery energy, clean the load whenever possible.

3..... Under CE and UKCA requirements, the lifter must maintain a vacuum level **greater than 8" Hg [-27 kPa]**.

# INSPECTIONS AND TESTS

Perform the following tests before placing the lifter in service *initially* and *following any repair*, when directed in the “*INSPECTION SCHEDULE*”, or *whenever necessary*:

## Operational Tests

Test all features and functions of the lifter (see “OPERATING FEATURES” and “OPERATION”).

## Vacuum Test

- 1) Clean the face of each vacuum pad (see “*Pad Cleaning*”).
- 2) Use a test load with weight equal to the Maximum Load Capacity, a clean, smooth, nonporous surface and other appropriate “*LOAD CHARACTERISTICS*”.<sup>1</sup> 
- 3) Attach the lifter to the test load as previously directed. After the vacuum pump stops running, the vacuum level should appear in the green range on each of the vacuum gauges.
- 4) Raise the load a minimal distance. Then hold the “function” button (Fn) and the “power” button (⏻) for at least 5 seconds to power down the lifter.<sup>2</sup>

 **Take precautions in case load should fall during test.**
- 5) Watch the vacuum gauges: *The vacuum level should not decrease by more than 4" Hg [-14 kPa] in 5 minutes.*
- 6) Lower the load after 5 minutes or whenever a lifter fails the test, and release the load as previously directed. 

 **Never use lifter that has failed test.**
- 7) Qualified service personnel must correct any fault in the vacuum system before the lifter can be returned to service. 

 **This service must be performed by qualified service personnel.**

1..... The load should have either a flat surface or no more curvature than the lifter is designed for, if any.

2..... During this time, the LCD screen displays “WARNING: Is load attached?”, the notification buzzer chirps and the strobe light flashes.

# INSPECTIONS AND TESTS

## Rated Load Test<sup>1</sup>

The following steps must be performed or supervised by a qualified person:<sup>2</sup>

- 1) Use a test load that weighs 125% ( $\pm 5\%$ ) of the Maximum Load Capacity and has the appropriate “LOAD CHARACTERISTICS”. 
- 2) Attach the vacuum pads to the load as previously directed.
- 3) Position the load to produce the greatest stress on the lifter consistent with “INTENDED USE”.
- 4) Raise the load a minimal distance and leave it suspended for 2 minutes.
- 5) Once the test is completed, lower and release the load as previously directed.
- 6) Inspect the lifter for any stress damage, and repair or replace components as necessary to successfully pass the test.
- 7) Prepare a written report of the test and keep it on file.



**Take precautions in case load should fall during test.**



**Never use lifter that has failed test.**

## Remote Control System Test

 If the lifter has a Remote Control System, test it where the lifter is normally used. Use the radio transmitter to activate each of the remote functions.<sup>3</sup> Vary the transmitter's direction and distance from the lifter, to make sure transmissions are effective.<sup>4</sup>

If the Remote Control System is not functioning correctly, ...

- the battery for the radio transmitter may need to be replaced, or;
- metal or other electrically conductive surfaces may be causing radio interference. Reposition the transmitter to transmit signals effectively.

If the problem persists, vary the test conditions, to determine whether there is transmission interference in the work environment or the Remote Control System is not functioning. Correct any fault before using the Remote Control System.

1..... An equivalent simulation may also be used. Contact WPG for more information.

2..... A “qualified person” has successfully demonstrated the ability to solve problems relating to the subject matter and work, either by possessing a recognized degree in an applicable field or a certificate of professional standing, or by possessing extensive knowledge, training and experience.

3..... Use a test material with appropriate “LOAD CHARACTERISTICS” to test the “attach” and “release” functions.

4..... This may require assistance from someone near the lifter, to verify functions are working as intended.

# MAINTENANCE

Note: Refer to **SERVICE MANUAL #36106** when applicable.

## VACUUM PAD MAINTENANCE

### Pad-to-Load Friction Coefficient

The friction coefficient represents the lifter's ability to resist load slippage. The Maximum Load Capacity is based on a friction coefficient of 1, as determined by testing of clean, new, standard rubber vacuum pads on clean, dry, regular glass. **If the lifter is used under any other conditions, a qualified person must first determine the effective lifting capacity.**<sup>1</sup>



Long-term exposure to heat, chemicals or UV light can damage vacuum pads. Replace pads and sealing rings (if applicable) every 2 years or more often when necessary.

### Pad Inspection

Inspect each vacuum pad (fig. 1A) according to the “**INSPECTION SCHEDULE**” and correct the following faults before using the lifter (see “**REPLACEMENT PARTS**”, when applicable):

- Contaminates on the face (item 1 in fig. 1A) or sealing edges (item 2 in fig. 1A).
- Filter screen (item 3 in fig. 1A) missing from face.



**Replace any pad that has damaged sealing edges.**

- Nicks, cuts, deformation or abrasions in sealing edges.<sup>2</sup>
- Wear, stiffness or glaze.

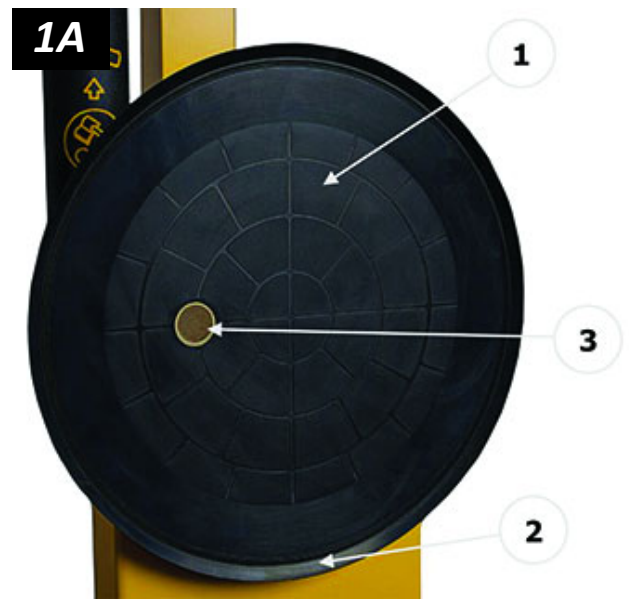

1..... A “qualified person” has successfully demonstrated the ability to solve problems relating to the subject matter and work, either by possessing a recognized degree in an applicable field or a certificate of professional standing, or by possessing extensive knowledge, training and experience.

2..... If the lifter has VPFS10T pads, the replaceable sealing ring is the sealing edge.

## Pad Cleaning

- 1) Regularly clean the face of each vacuum pad (fig. 1A), using soapy water or other mild cleansers to remove oil, dust and other contaminants.



***Never use harsh chemicals on vacuum pad.***

Solvents, petroleum-based products (including kerosene, gasoline and diesel fuel) or other harsh chemicals can damage vacuum pads.



***Never use rubber conditioners on vacuum pad.***

Many rubber conditioners can leave a hazardous film on vacuum pads.

- 2) Prevent liquid from entering the vacuum system through the suction hole on the pad face.
- 3) Wipe each pad face clean, using a clean sponge or lint-free cloth to apply the cleanser.<sup>1</sup>
- 4) Allow each pad to dry completely before using the lifter.



<sup>1</sup>..... A brush with bristles *that do not harm rubber* can help remove contaminants clinging to sealing edges. If these cleaning methods are not successful, contact WPG or an authorized dealer for assistance.

# MAINTENANCE

## TO REPLACE SEALING RING IN VPFS10T PADS

If the lifter has VPFS10T vacuum pads, replace sealing rings (#49724RT or #49724TT) as follows:

- 1) Remove the old sealing ring (fig. 1A).

*Note: Make sure the entire vacuum pad is clean, including the mounting groove.*

- 2) Place the inside edge of a new sealing ring against the inside edge of the mounting groove (fig. 2A).

- 3) Push the sealing ring into the mounting groove, beginning in 4 locations as shown circled in fig. 3A.

- 4) Push gently and firmly on the outside edge of the sealing ring until the flat side fits flush against the bottom of the mounting groove (fig. 4A). A pad ring installation tool (circled in fig. 4A) makes this step easier (see [“REPLACEMENT PARTS”](#)).

- 5) Make sure the sealing ring seats securely in the mounting groove, all the way around the vacuum pad (fig. 5A).

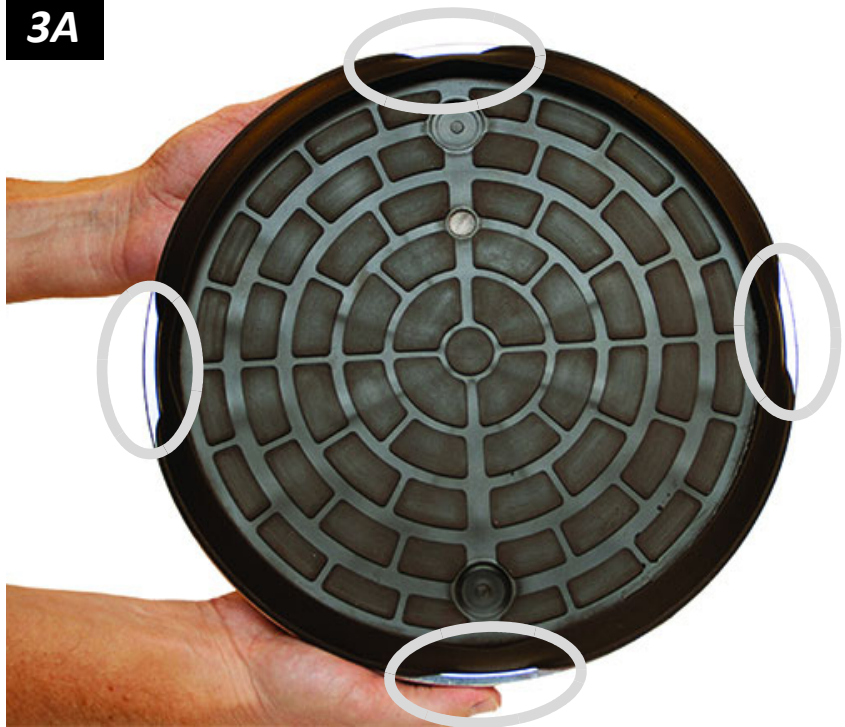
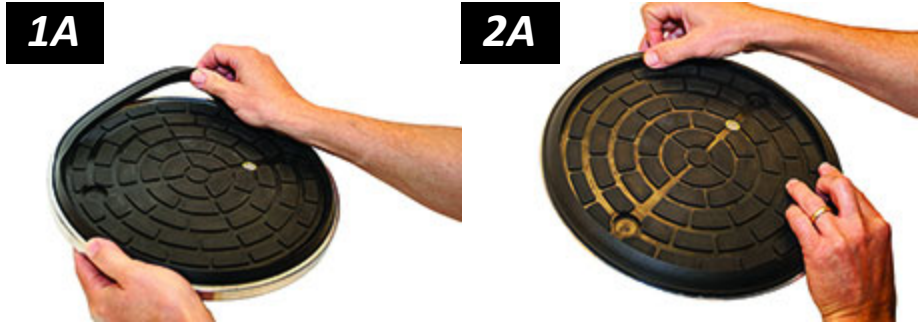

*Note: If any part of the sealing ring comes out of the mounting groove, inspect the sealing ring for damage and reinstall an undamaged sealing ring.*



## 12-VOLT BATTERY RECHARGE<sup>1</sup>

Charge the battery whenever the battery gauge shows reduced energy.<sup>2</sup> **Caution:** Make sure the lifter is powered down.

Identify the input voltage marked on the battery charger and plug it in to an appropriate power source.<sup>3</sup>



**Make sure power source has ground fault circuit interrupter.**

The power lamp (Φ) turns on when the charger is functioning. Consult the six-stage display to determine the charging status. The battery can be used after stage 3 and is fully charged at stage 5.

Normally, the battery should take no more than 8 hours to charge completely.<sup>4</sup> If not, check for the following faults:

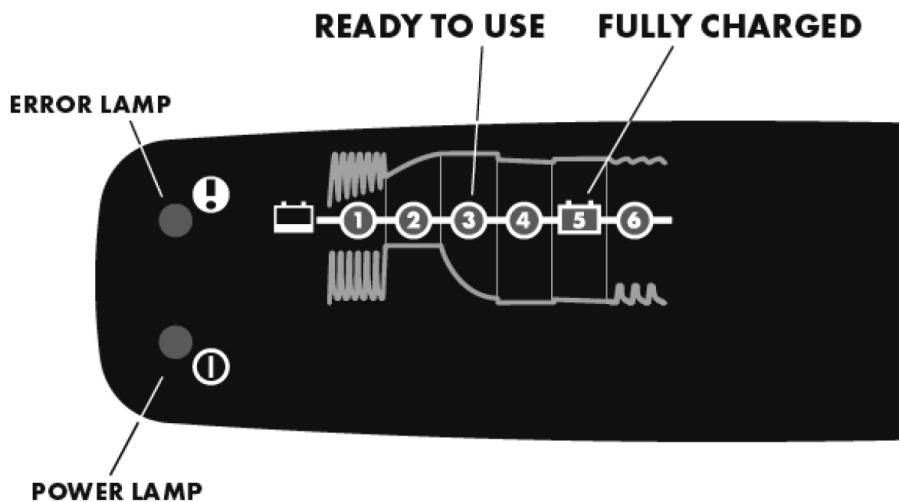

- Power lamp (Φ) flashes: Charger is not connected to battery; reconnect charger (see [“ASSEMBLY”](#)).
- Error lamp (!) turns on immediately: Battery leads connected to the wrong poles; reverse battery leads.
- Charging stops at either stage 1 or stage 4, and error lamp (!) turns on: Battery is no longer functioning; replace battery (see [“REPLACEMENT PARTS”](#)).

Before you return the lifter to service, recheck the battery as previously directed.

1..... You may use a battery charger other than the one supplied, provided it is designed for 12-volt DC, AGM type, lead-acid batteries. Disconnect the battery from the vacuum generating system before charging.

2..... To maximize the battery's lifespan, charge it promptly after each use.

3..... Any external power supply must conform to all applicable local codes. The lifter is not intended for use while the charger is connected to AC power.

4..... The charger automatically reduces the charging rate when the battery is fully charged.

# MAINTENANCE

## NOTIFICATION BUZZER BATTERY REPLACEMENT

- 1) Power down the lifter.
- 2) Release the buzzer battery holder by pressing inward and sideward in the direction marked on the holder.
- 3) Slide the battery tray out (fig. 3A).
- 4) Install a new 9-volt battery according to the polarity markings.
- 5) Slide the battery tray back into position.
- 6) Power up the lifter again, to test the new battery.



# MAINTENANCE

## INTELLI-GRIP® DIAGNOSTIC CODES

Refer to the following table when a diagnostic code appears on the LCD screen. Codes are listed in alphanumeric order. If the Explanations/Directions do not resolve the issue, contact qualified service personnel. All relevant parts are listed in **“REPLACEMENT PARTS”**.

Key:   = buzzer sounds      = buzzer sounds continuously      = strobe light flashes

Code	On-Screen Message	Buzzer Pattern	Strobe Light Activity	Explanations/Directions
B00	“Low 12V Battery (#)”	1 chirp every 2 seconds	(none)	Charge 12V <u>battery</u> or, if necessary, replace it (see <b>“12-VOLT BATTERY RECHARGE”</b> ). Cold battery may need to be warmed and/or charged more often.
B01	“Lockout (low 12V battery) (#)”	continuous	(none)	Once “Power Save” mode is activated, “attach” and “release” functions are prevented because 12V <u>battery</u> energy is insufficient. Charge battery before next lift (see <b>“12-VOLT BATTERY RECHARGE”</b> ).
B02	“Replace 12V battery?”	1 chirp per minute	(none)	Check condition of 12V <u>battery</u> (see <b>“Checking the 12-Volt Battery”</b> and <b>“12-VOLT BATTERY RECHARGE”</b> ). Since cold battery may prematurely activate this notification, warm battery and retest when appropriate. Replace battery as needed. Note: This notification can be activated in error if <u>battery charger</u> is plugged into power source while lifter is powered up. If so, power down lifter, disconnect charger from power source, and power up again. If code persists, check battery condition as directed above.
B03	“Charge 12V battery soon”	1 chirp per minute	(none)	Charge 12-volt <u>battery</u> (see <b>“12-VOLT BATTERY RECHARGE”</b> ).
B09	“Replace 9V battery?”	1 chirp per minute	(none)	Replace 9V battery for <u>notification buzzer</u> as needed (see <b>“NOTIFICATION BUZZER BATTERY REPLACEMENT”</b> ).
C00	“Fail-safe on module”	continuous	on	Fail-safe mode has been activated, to prevent potential injury. Service is required.
C011	“Communication failure, module 1”	fast chirp	(none)	If code does not clear automatically, service is required.
C021	“Internal error, module 1”	continuous	(none)	If code does not clear automatically, service is required.
C04	“Module revision not compatible”	1 chirp every 2 seconds	(none)	Make sure lifter is used within Operating Temperatures (see <b>“SPECIFICATIONS”</b> ). Then power lifter down and up again. If code persists, service is required.
C05	“Module revision lockout”	continuous (while button is held)	(none)	Once “Power Save” mode is activated, “attach” and “release” functions are prevented in connection with Code C04. Service is required.
C06	“Control head revision not compatible”	1 chirp every 2 seconds	(none)	Incompatible version of software was installed or <u>Intelli-Grip® control unit</u> has failed. Service is required.

# MAINTENANCE

Code	On-Screen Message	Buzzer Pattern	Strobe Light Activity	Explanations/Directions
C07	"Control head revision lockout"	continuous (while button is held)	(none)	Once "Power Save" mode is activated, "attach" and "release" functions are prevented in connection with Code C06. Service is required.
E00 E01 E02 E03 E04	"EEPROM error, cell #"	occasional chirp	(none)	Memory error detected. Service is required.
I000	"I2C error (#)"	single chirp	(none)	If code does not clear automatically, service is required.
N00	"Automatic attach"	(none)	(none)	System activated "attach" mode as precaution because significant vacuum was detected, even though no one initiated "attach" function. No corrective action is necessary.
N01	"Automatic attach"	(none)	(none)	System activated "attach" mode as precaution because load did not release completely. No corrective action is necessary.
N02	"Automatic attach"	(none)	(none)	System activated "attach" mode as precaution when lifter was powered up because power was previously lost while load was attached. No corrective action is necessary.
N03	"Unable to turn module power off"	1 chirp every 2 seconds	(none)	Remove 9V battery. Disconnect connector between 12V <u>battery</u> and vacuum generating system. Charge battery completely (see "12-VOLT BATTERY RECHARGE"). Then reconnect battery and try to power down again. If code persists, disconnect connector. Service is required.
N04	"Failed to turn controls power off"	1 chirp every 2 seconds	(none)	Remove 9V battery. Disconnect connector between 12V <u>battery</u> and vacuum generating system. Charge battery completely (see "12-VOLT BATTERY RECHARGE"). Then reconnect battery and try to power down again. If code persists, disconnect connector. Service is required.
N05	"Unable to turn module power on"	1 chirp every 2 seconds	(none)	Charge 12V <u>battery</u> (see "12-VOLT BATTERY RECHARGE"). Then power lifter up again. If code persists, service is required.
N06	"Power-down reminder"	2 chirps	on briefly	Power down to prevent 12V <u>battery</u> discharge when lifter is not in use.
N07	"Auto power-down disabled"	(none)	(none)	Automatic power-down is prevented. Power lifter down and up again. If code persists, service is required.
N08	"powering down in # seconds"	1 chirp per minute	(none)	Lifter will automatically power down in number of seconds shown. Press any button to cancel action.
N10	"App-support hardware fault"	(none)	(none)	Fault is detected in hardware that enables communication with mobile app. Power lifter down and up again. If code persists, service is required.
U00	"WARNING! Is load attached?"	fast chirp	on	Attempt was made to power down lifter while load was still detected. Lower load onto stable support and release load <i>before</i> powering down lifter.
U01	"Also hold [Fn] to power down"	(none)	(none)	Hold " <u>function</u> " <u>button</u> and " <u>power</u> " <u>button</u> at same time to power down lifter.

# MAINTENANCE

Code	On-Screen Message	Buzzer Pattern	Strobe Light Activity	Explanations/Directions
U02	"Turn off? Let go of buttons"	(none)	(possible)	Use only <u>"function" button</u> and <u>"power" button</u> to power down lifter. Lifter cannot be powered down while any other button is pressed.
U03	"Timed release: # seconds"	1 chirp per button press	on	Timed release function is activated for number of seconds shown (see <u>"TO RELEASE THE PADS FROM THE LOAD"</u> ). Press <u>"function" button</u> to cancel action or press <u>"attach" button</u> to override. No corrective action is necessary.
U04	"Also hold [Fn] to release"	(none)	(none)	Hold <u>"function" button</u> and <u>"release" button</u> at same time to release load.
U06	"Let go of [Fn] and Release"	(none)	on	Use only <u>"attach" button</u> to attach load. While <u>"attach" button</u> is pressed, lifter does not respond to pressing any other button. Release all buttons and press button(s) again to activate different function.
U08	"Menu not available in Attach"	(none)	(none)	Operator Menus cannot be accessed while lifter is attached to load.
U09	"Counterweight not retracted"	continuous	on	"Release" function is prevented because counterweight is not positioned correctly. Reposition counterweight as directed (see Counter-Balancer <i>OPERATING INSTRUCTIONS</i> , if necessary).
U10	"Use POWER button for Live Stats"	(none)	(none)	<u>"Power" button</u> (not <u>"function" button</u> ) is now used to access Live Stats. No corrective action is necessary.
U11	"Testing battery - wait to attach"	(none)	(none)	"Attach" function is prevented because <u>battery test</u> is in progress. Wait until <u>vacuum pump</u> stops running and try again.
V000	"INSUFFICIENT VACUUM!"	continuous	on	Immediately lower load onto stable support until adequate vacuum can be obtained. Check load and <u>vacuum pads</u> for damage. Consult relevant topics in "ASSEMBLY", "OPERATION", "INSPECTIONS AND TESTS", and "MAINTENANCE".
V001 V002 V003 V004	"INSUFFICIENT VACUUM #!" (# indicates relevant vacuum circuit)	continuous	on	Immediately lower load onto stable support until adequate vacuum can be obtained in vacuum circuit indicated. Check load and <u>vacuum pads</u> for damage. Consult relevant topics in "ASSEMBLY", "OPERATION", "INSPECTIONS AND TESTS", and "MAINTENANCE". This code can be activated in connection with Code N00.
V011 V012 V013 V014 V015	"Vacuum decrease on circuit #" (# indicates relevant vacuum circuit)	3 chirps	(none)	Vacuum decreased at greater rate than expected in circuit(s) indicated. Possible causes include bouncing or landing load, as well as use on rough or porous loads and other sources of vacuum leaks. Consult relevant topics in "ASSEMBLY", "OPERATION", "INSPECTIONS AND TESTS", and "MAINTENANCE" to eliminate leaks when possible. When appropriate, you can also adjust sensitivity to vacuum level reductions (see "INTELLI-GRIP® OPERATOR MENUS: TO CHANGE THE LEAK RATE THRESHOLD" in <i>SERVICE MANUAL</i> ).
V020	"Vacuum not increasing normally"	1 chirp every 2 seconds	on	Although lifter began to attach, vacuum level did not increase at normal rate. Make sure all <u>vacuum pads</u> seal securely (see <u>"Sealing the Pads on the Load"</u> and <u>"Reading the Vacuum Gauges"</u> ). This Code can be activated by use at high elevation. If so, contact WPG for directions.

# MAINTENANCE

Code	On-Screen Message	Buzzer Pattern	Strobe Light Activity	Explanations/Directions
V03A V03B	"Pump running excessively"	1 chirp every 2 seconds	(none)	<u>Vacuum pump</u> is running more often than normal. Likely causes include significant vacuum leak or difficulty achieving minimum vacuum level due to high elevation. In case of suspected leak, check for fault(s) in vacuum system. See relevant topics in "ASSEMBLY," "OPERATION" "INSPECTIONS AND TESTS", and "MAINTENANCE". In case of high elevation, contact WPG for directions.
V040	"Lockout (vacuum sensor error)"	continuous	(none)	Once "Power Save" mode is activated, "attach" and "release" functions are prevented due to a <u>vacuum sensor</u> malfunction. Make sure sensor connectors are attached correctly.
V050	"DANGER! INSUFFICIENT VACUUM!"	continuous	on	Vacuum levels in BOTH circuits are insufficient for lifting. <b>Keep everyone away from suspended load until it can be safely lowered to a stable support.</b> Service is required.
V081 V082 V083 V084	"Sensor # error (low)"  (# indicates relevant vacuum circuit)	continuous in "attach" mode; 1 chirp every minute in "power save" mode	(none)	<u>Vacuum sensor</u> malfunction in vacuum circuit indicated. Make sure sensor connector is attached correctly.
V091 V092 V093 V094	"Sensor # error (high)"  (# indicates relevant vacuum circuit)	continuous in "attach" mode; 1 chirp every minute in "power save" mode	(none)	<u>Vacuum sensor</u> malfunction in vacuum circuit indicated. Make sure sensor connector is attached correctly.

# REPLACEMENT PARTS

Stock No.	Description	Qty.
65442CA	Vacuum Hose – 0.160" ID x 1/4" OD – Red	*
65440	Vacuum Hose – 0.245" ID x 3/8" OD – Red	*
65437	Vacuum Hose – 0.245" ID x 3/8" OD – Green	*
65429BM	Vacuum Hose – 0.160" ID x 1/4" OD – Green	*
64715	Battery Charger – 0.8 Amp – 240 V AC	1
64714	Battery Charger – 0.8 Amp – 100 / 120 V AC	1
64664	Battery – 12 V DC – 7 Amp-Hours	1
59906	Remote Control System Retrofit Kit (optional)	1
59086NC	Battery Connector – Twin Lead	1
57012	Pad Channel Tilt Pin	1
54390NC	Power Lead	1
53122	Pad Fitting – Elbow – 5/32" ID	4
49724TT	Sealing Ring – Model VIFS10T2 – Closed Cell Foam (for VPFS10T pads)	4
49724RT	Sealing Ring – Model VIFS10T3 – Heat-Resistant Rubber (for VPFS10T pads)	4
49672FT	Vacuum Pad – Model VPFS10T / 10" [25 cm] Diameter – w/Replaceable Sealing Ring	4
49646T	Vacuum Pad – Model G3370 / 11" [28 cm] Diameter – Lipped	4
49605T	Vacuum Pad – Model HV11 / 10" [25 cm] Diameter – Lipped (option)	4
49586TA	Vacuum Pad – Model G0750 / 10" [25 cm] Diameter – Concave	4
49130	End Plug – 2" x 3" x 1/4" Tubing Size	2
36106	Service Manual – 12 V DC – Dual Vacuum System – Intelli-Grip®	1
29353	Pad Cover	4
20050	Pad Ring Installation Tool (for VPFS10T pads)	1
15632	Pad Filter Screen – Small (for G0750 & VPFS10T pads)	4
15630	Pad Filter Screen – Large (for G3370 & HV11 pads)	4
15624	Hose Fitting – Y-Connector – 1/4" Barb	4
10005	Machine Screw – 1/4-20 x 1" (for HV11 pad mounting)	**
10003	Machine Screw – 1/4-20 x 3/4" (for pad mounting)	**
10002	Machine Screw – 1/4-20 x 1/2" (for pad mounting)	**

\* Length as required; sold by the foot (approx 30.5 cm)

\*\* Quantity as required

See **SERVICE MANUAL #36106** for additional parts.

**SERVICE ONLY WITH IDENTICAL REPLACEMENT PARTS,  
AVAILABLE AT [WPG.COM](http://WPG.COM) OR THROUGH AN AUTHORIZED WPG DEALER**

# LIMITED WARRANTY

Wood's Powr-Grip® (WPG) products are carefully constructed, thoroughly inspected at various stages of production, and individually tested. They are warranted to be free from defects in workmanship and materials for a period of one year from the date of purchase.

If a problem develops during the warranty period, follow the instructions below to obtain warranty service. If inspection shows that the problem is due to defective workmanship or materials, WPG will repair the product without charge.

## **Warranty does not apply when ...**

- modifications have been made to the product after leaving the factory
- rubber portions have been cut or scratched during use;
- repairs are required due to abnormal wear and tear, and/or;
- the product has been damaged, misused or neglected.

If a problem is not covered under warranty, WPG will notify the customer of costs prior to repair. If the customer agrees to pay all repair costs and to receive the repaired product on a C.O.D. basis, then WPG will proceed with repairs.

## **TO OBTAIN REPAIRS OR WARRANTY SERVICE**

### **For purchases in *North America*:**

Contact the WPG Technical Service Department. When factory service is required, ship the complete product – prepaid – along with your name, address and phone number to the street address listed at the bottom of this page. WPG may be reached by phone or fax numbers listed below.

### **For purchases in all *other localities*:**

Contact your dealer or the WPG Technical Service Department for assistance. WPG may be reached by phone or fax numbers listed below.

Wood's Powr-Grip Co., Inc.

908 West Main St.

Laurel, MT 59044 USA

406-628-8231 (phone)

800-548-7341 (phone)

406-628-8354 (fax)



KEEP FOR FUTURE REFERENCE

# ENGINEERING DRAWINGS



908 W. Main • P.O. Box 368

Laurel, MT USA 59044

800-548-7341 (phone) • 406-628-8231 (phone)

406-628-8354 (fax) • [www.WPG.com](http://www.WPG.com)



**INTENDED FOR USE BY SKILLED TECHNICAL  
PROFESSIONALS • READ AND UNDERSTAND  
BEFORE ROUTING, WIRING AND/OR ASSEMBLING**



**SINGLE-CHANNEL  
LIFTER, DC-VOLTAGE,  
WITH INTELLI-GRIP®  
TECHNOLOGY**

Model numbers: P110T04DC3, P110C04DC3, P11104DC3

**WIRE LEGEND: CONTROLLED BY WIRING SYMBOLS DRAWING EXCEPT AS NOTED AND BELOW.**

**LINE STYLES AND WIDTHS FOR WIRE UNLESS NOTED OTHERWISE.**

.....	24AWG	22AWG	20AWG
.....	18AWG	16AWG	N/A

PRODUCT MANAGER:	DATE:
MARTY P.	07/27/2020
CHECKED:	
MAP	10/27/2021
APPROVED:	

TYPE:	PROJECT	FILE DIRECTORY:	20130901.03.00
		FILE (SHEET):	RD00500A-W01 [A-W01]
THIS DRAWING IS THE PROPERTY OF <b>WOOD'S POWR-GRIP CO., INC.</b> LAUREL, MONTANA U.S.A.			
DC3 DESIGN REVIEW N/A PUMP COVER WIRING SCHEMATIC RD00500A-W01 [A-W01]			
SIZE:	SCALE:	REVISION:	ECN NUMBER:
A	NONE	01.A	VER 01.A
		ECN DATE:	ECN BY:
		10/27/2021	MAP
		EST. WEIGHT:	N/A

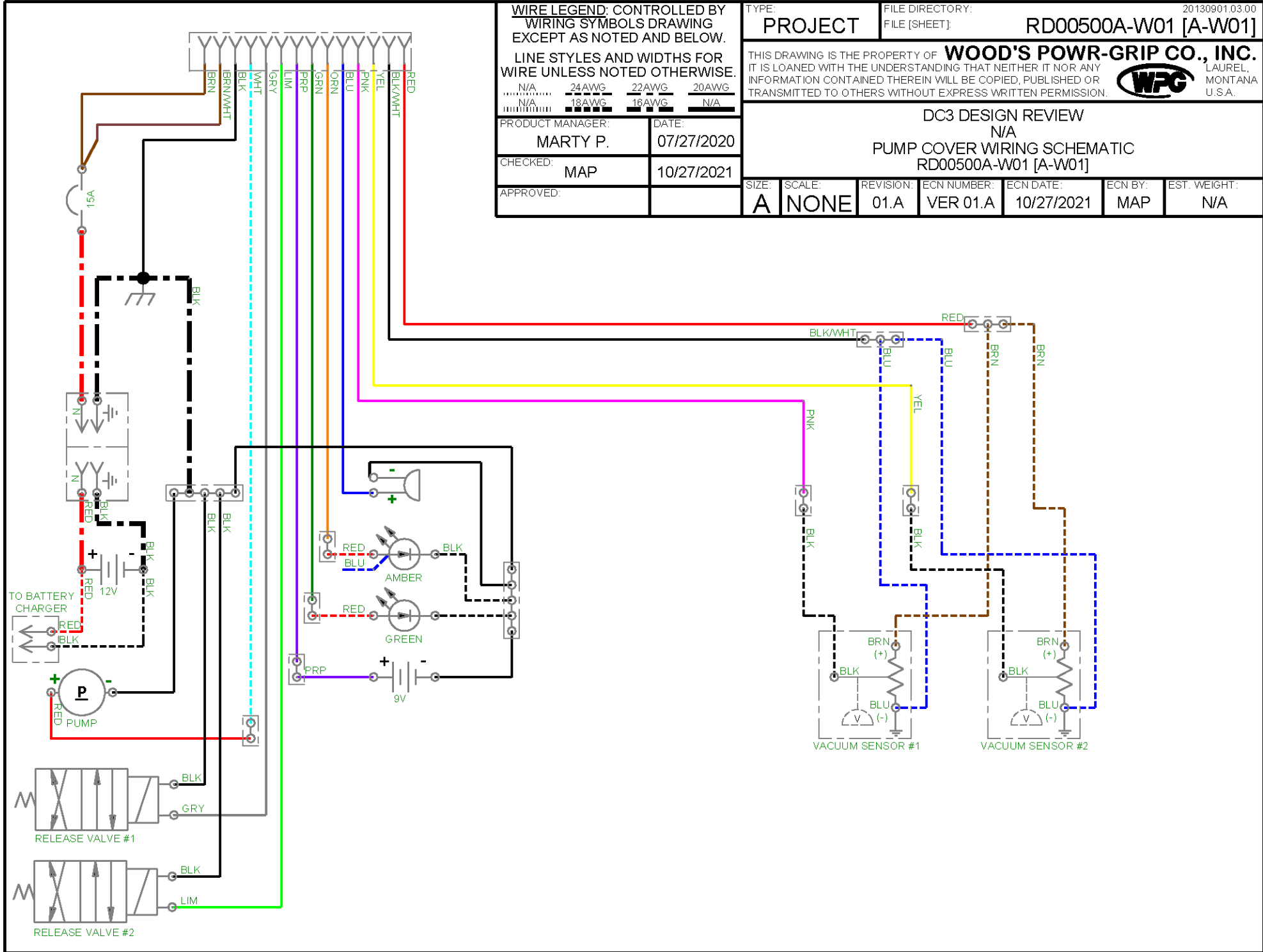

WIRE LEGEND: CONTROLLED BY WIRING SYMBOLS DRAWING EXCEPT AS NOTED AND BELOW.

TYPE: STANDARD

FILE DIRECTORY: FILE [SHEET]:

713K-W01 [K-W01]

LINE STYLES AND WIDTHS FOR WIRE UNLESS NOTED OTHERWISE.

N/A	22 AWG	N/A	18 AWG
N/A	N/A	N/A	N/A

THIS DRAWING IS THE PROPERTY OF **WOOD'S POWR-GRIP CO., INC.** IT IS LOANED WITH THE UNDERSTANDING THAT NEITHER IT NOR ANY INFORMATION CONTAINED THEREIN WILL BE COPIED, PUBLISHED OR TRANSMITTED TO OTHERS WITHOUT EXPRESS WRITTEN PERMISSION.



PRODUCT MANAGER: GARY B. DATE: 12/01/2017

CHECKED: CR 06-17-20

APPROVED: CURR 6-17-20

RADIO REMOTE CONTROL  
MRT4-DC3  
5-PIN DC3 RADIO RECEIVER WIRING SCHEMATIC, FCC & CE  
D713K-W01 [K-W01]

SIZE: A	SCALE: NONE	REVISION: 04.A	ECN NUMBER: 4897	ECN DATE: 05/21/2020	ECN BY: CCH	EST. WEIGHT: N/A
---------	-------------	----------------	------------------	----------------------	-------------	------------------

