

# TOP LOAD WASHERS

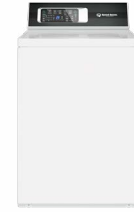
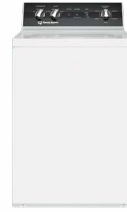
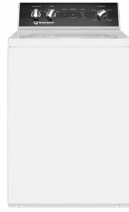

**TR3**

**TR5**

**TR7**

**TC5**

Product Code	TR3003WN	TR5003WN	TR7003WN	TC5003WN
Available Colors	White	White	White	White
Capacity – Cu. Ft.	3.2	3.2	3.2	3.2
Stainless Steel Wash Tub	•	•	•	•
Porcelain Outer Tub	•	•	•	•
Preset Cycles	4	6	8	6
Preset Special Cycles			8	
Variable Speed, 1 HP Motor	•	•	•	
Two-Speed, ½ HP Motor				•
Automatic Balancing System	•	•	•	•
Agitator	•	•	•	•
Durable 3 - Coat Finish	•	•	•	•
Prewash			•	
Load Size Selections	3	3	4	2
Temperature Selections	3	4	4	4
Soil Level Selections	2	2	4	2
Time Remaining Display			•	
End-of-Cycle Signal	•	•	•	•
Favorite Cycles			•	
Speed Cycle			•	
Delay Start			•	
Warranty	3-Year Parts & Labor	5-Year Parts & Labor	7-Year Parts & Labor	5-Year Parts & Labor
Model No.	AWN43RSN116TW01	AWN63RSN116TW01	AWNE9RSN116TW01	AWN632SP116TW02

Agency approvals: cULus

For the most accurate information, the installation guide should be used for all design and construction purposes. Due to continuous product improvements, design and specifications are subject to change without notice. The quality management systems of Alliance Laundry Systems are registered to ISO 9001.

Dimensions	W-Width	H-Height	D-Depth	Height with Lid Open
<b>TR3003WN</b>	25 5/8"	42 3/4"	28"	53"
<b>TR5003WN</b>	25 5/8"	42 3/4"	28"	53"
<b>TR7003WN</b>	25 5/8"	42 3/4"	28"	53"
<b>TC5003WN</b>	25 5/8"	42 3/4"	28"	53"

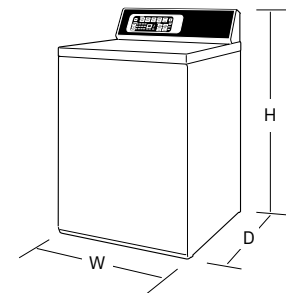

## Optional Accessories

Drain Extension Kit – Part No: 204512

Hose Kit – Part No: 807239

Siphon Break Kit – Part No: 562P3

# Dimensions

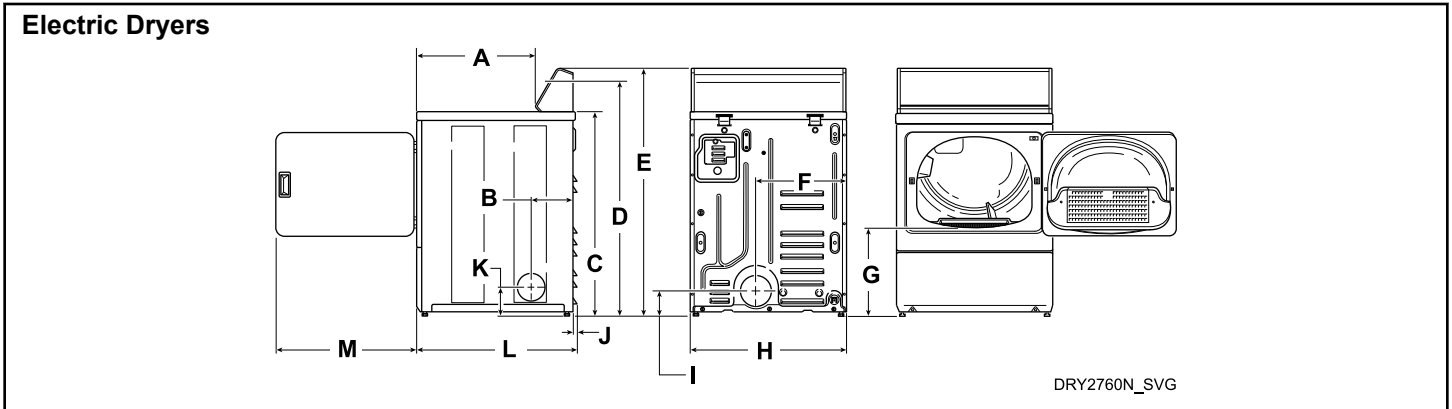

A	22.38 in. [569 mm]
B	8.0 in. [203 mm]
C	* 36 in. [914 mm]
D (to controls)	Electronic Control: *41.25 in. [1048 mm] Knob Control: *40.75 [1035 mm]
E	* 42.75 in. [1086 mm]
F	15.4 in. [391 mm]
G	* 15.44 in. [392 mm]
H	26.875 in. [683 mm]
I	* 4.0 in. [102 mm]
J	0.4 in. [11 mm]
K	* 4.5 in. [114 mm]
L	28 in. [711 mm]
M	23.5 in. [597 mm]
<b>NOTE: Exhaust openings are 4 inch [102 mm] metal ducting.</b>	* With leveling legs turned into base.

# DRYERS



**DR7**

**DR5**

**DR3**

**DC5**

Product Code	Gas:	DR7003WG	DR5003WG	DR3003WG	DC5003WG
	Electric:	DR7003WE	DR5003WE	DR3003WE	DC5003WE
Capacity – Cu. Ft.		7.0	7.0	7.0	7.0
Galvanized Cylinder		•	•	•	•
ADA Compliant		•	•	•	•
Cylinder Light		•	•	•	•
Reversible Door		•	•	•	•
Lint Filter Guard		•	•	•	•
Sanitize		•	•	•	•
Preset Cycles		10	9	3	4
Temperature Selections		4	5	3	4
End-of-Cycle Signal		•	•		•
Extended Tumble		•	•		•
Moisture Sensor		•	•		
Commercial Cool-Down Technology		•	•		
ENERGY STAR® Certified		•	•		
Steam Boost		•	•		
Steam Refresh		•	•		
Steam Sanitize		•			
Anti-Static		•			
Time Remaining Display		•			
Favorite Cycles		•			
Pet Plus™ Cycles		•			
Warranty		7-Year Parts & Labor	5-Year Parts & Labor	3-Year Parts & Labor	5-Year Parts & Labor
Model No. (Gas)		ADGE9RYS117TW01	ADG6HRY117TW01	ADG3SRGS117TW01	ADG4BRGS117TW01
(Electric)		ADEE9RYS177TW01	ADE6HRY177TW01	ADE3SRGS177TW01	ADE4BRGS177TW01

For the most accurate information, the installation guide should be used for all design and construction purposes. Due to continuous product improvements, design and specifications are subject to change without notice. The quality management systems of Alliance Laundry Systems are registered to ISO 9001.

Dimensions	W-Width	H-Height	D-Depth	WSH-Work Surface Height	Depth with Door Open
<b>DR7003WG / DR7003WE</b>	26 7/8"	42 3/4"	28"	36"	51 1/2"
<b>DR5003WG / DR5003WE</b>	26 7/8"	42 3/4"	28"	36"	51 1/2"
<b>DR3003WG / DR3003WE</b>	26 7/8"	42 3/4"	28"	36"	51 1/2"
<b>DC5003WG / DC5003WE</b>	26 7/8"	42 3/4"	28"	36"	51 1/2"

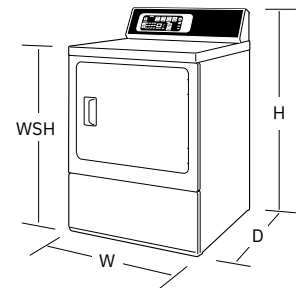

## Optional Accessories

- Drying Rack – Part No: D512082
- Directional Exhaust Kit – Part No: 528P3
- Conversion Kit = Gas to LP – Part No: 649P3
- Flexible Metal Vent Kit – Part No: 521P3

Agency approvals: cULus, CSA us star, MA gas board

# DRYERS



**DR7**

**DR5**

**DR3**

**DC5**

Product Code	Gas:	DR7003WG	DR5003WG	DR3003WG	DC5003WG
	Electric:	DR7003WE	DR5003WE	DR3003WE	DC5003WE
Capacity – Cu. Ft.		7.0	7.0	7.0	7.0
Galvanized Cylinder		•	•	•	•
ADA Compliant		•	•	•	•
Cylinder Light		•	•	•	•
Reversible Door		•	•	•	•
Lint Filter Guard		•	•	•	•
Sanitize		•	•	•	•
Preset Cycles		10	9	3	4
Temperature Selections		4	5	3	4
End-of-Cycle Signal		•	•		•
Extended Tumble		•	•		•
Moisture Sensor		•	•		
Commercial Cool-Down Technology		•	•		
ENERGY STAR® Certified		•	•		
Steam Boost		•	•		
Steam Refresh		•	•		
Steam Sanitize		•			
Anti-Static		•			
Time Remaining Display		•			
Favorite Cycles		•			
Pet Plus™ Cycles		•			
Warranty		7-Year Parts & Labor	5-Year Parts & Labor	3-Year Parts & Labor	5-Year Parts & Labor
Model No. (Gas)		ADGE9RYS117TW01	ADG6HRY117TW01	ADG3SRGS117TW01	ADG4BRGS117TW01
(Electric)		ADEE9RYS177TW01	ADE6HRY177TW01	ADE3SRGS177TW01	ADE4BRGS177TW01

For the most accurate information, the installation guide should be used for all design and construction purposes. Due to continuous product improvements, design and specifications are subject to change without notice. The quality management systems of Alliance Laundry Systems are registered to ISO 9001.

Dimensions	W-Width	H-Height	D-Depth	WSH-Work Surface Height	Depth with Door Open
<b>DR7003WG / DR7003WE</b>	26 7/8"	42 3/4"	28"	36"	51 1/2"
<b>DR5003WG / DR5003WE</b>	26 7/8"	42 3/4"	28"	36"	51 1/2"
<b>DR3003WG / DR3003WE</b>	26 7/8"	42 3/4"	28"	36"	51 1/2"
<b>DC5003WG / DC5003WE</b>	26 7/8"	42 3/4"	28"	36"	51 1/2"

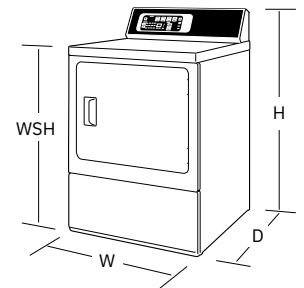

### Optional Accessories

- Drying Rack – Part No: D512082
- Directional Exhaust Kit – Part No: 528P3
- Conversion Kit = Gas to LP – Part No: 649P3
- Flexible Metal Vent Kit – Part No: 521P3

Agency approvals: cULus, CSA us star, MA gas board