

JAMSTANDS®

By Ultimate Support

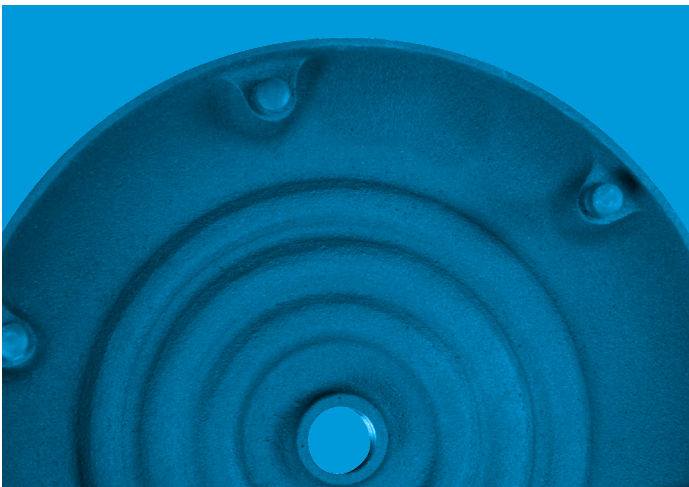

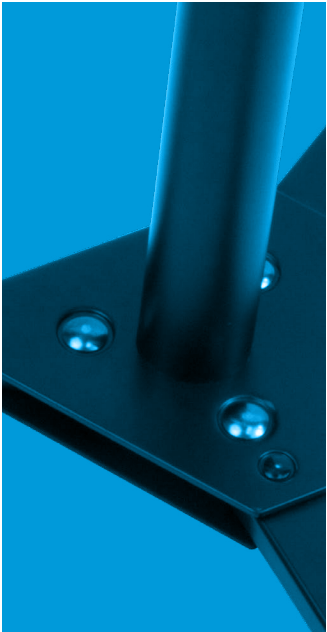

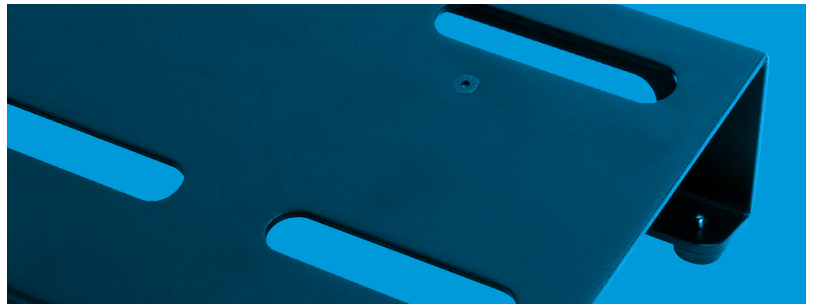











STOP DREAMING.
START DOING.



20
21

ULTIMATESUPPORT.COM
800.525.5628

MAIN MENU - [CLICK ON PRODUCT LINKS](#)

	STUDIO DESK	4
	RACK STANDS	4
	MONITOR STANDS	5
	LAPTOP STANDS	6
	TABLET STANDS	8
	KEYBOARD STANDS	9
	BENCHES & CHAIRS	12
	MIC STANDS (ACCESSORIES)	14
	GUITAR STANDS	22
	GUITAR HANGERS	25
	PEDALBOARD	26
	AMPLIFIER STANDS	26
	SPEAKER STANDS & POLES	28
	MUSIC STANDS	30
	EQUIPMENT CARTS	32



STUDIO FURNITURE & STANDS



STUDIO WORKSTATION JS-SW300

More surface area than the competition

Sturdy welded frame construction

Open design for extra leg room

Second tier

Sleek z-shaped design

Sliding keyboard tray



JS-SW300 item# 17359

The Slim and Sleek, Affordable Studio Workstation

JS-SW300 Features:

- Total workable surface area: 2335 sq. in.
- Weight capacity: 175 lbs.
- Finish: Black Laminate
- Height: Main Surface: 29.5", Keyboard Surface: 27.1", 2nd Tier Surface: 40.3"
- Width: Main: 48", Keyboard: 42", 2nd Tier: 42"
- Depth: Main: 24", Keyboard: 15", 2nd Tier: 18"

ROLLING RACK STAND JS-SRR100

More surface area than the competition

Sturdy welded frame construction

Open design for extra leg room

Second tier

Sleek z-shaped design

Sliding keyboard tray



JS-SRR100 item# 16804

Studio Rolling Rack

JS-SRR100 Features:

- 12U rack spaces over 9U rack spaces
- Angle-adjustable top rack
- High-quality casters for mobility
- Racking hardware included
- Open frame design for back panel easy access





MONITOR STAND JS-MS70

Height-adjustable stand for studio monitors

Locking pin ensures stable and accurate height positions

Leveling floor spikes and rubber feet included

Low-profile base can be easily positioned into tight spaces



JS-MS70 item# 17441
Studio Monitor Stands (Pair)

JS-MS70 Features:

- Height-adjustable stand for studio monitors
- Locking pin ensures stable and accurate height positions
- Leveling floor spikes and rubber feet included
- Low-profile base can be easily positioned into tight spaces

MONITOR STAND JS-MS70 PLUS

Height-adjustable stand for studio monitors

Locking pin ensures stable and accurate height positions

Height adjustable stand for studio monitors

Low profile base can be easily positioned into tight spaces

Base folds for easier storage



JS-MS70 Plus item# 17982
Studio Monitor Stands (Pair)

JS-MS70 Plus Features:

- Height-adjustable stand for studio monitors
- Locking pin ensures stable and accurate height positions
- Height adjustable stand for studio monitors
- Low profile base can be easily positioned into tight spaces
- Base folds for easier storage



ERGONOMIC COMPACT LAPTOP STAND JS-LPT500

Sturdy Features and Locking mechanisms ensure your laptop stays securely in place

Thin feet can slide under mixers and keyboards

Can be setup in multiple configurations and adjusted to ideal height

Compact design folds flat and slides easily into included tote



JS-LPT500 item# 17852
Ergonomic Compact Laptop Stand
FREE CARRYING BAG

JS-LPT500 Features:

- Sturdy Features and Locking mechanisms ensure your laptop stays securely in place
- Thin feet can slide under mixers and keyboards
- Can be setup in multiple configurations and adjusted to ideal height
- Compact design folds flat and slides easily into included tote



DOUBLE-TIER COMPACT LAPTOP STAND JS-LPT400

Multi-purpose stand: laptops, lighting controller, small mixer, CD player, DJ equipment, etc.

Vented second tier included to hold hard drives, USB hubs, audio interfaces, and more

Lightweight aluminum construction

Folds down for easy and convenient transport and storage

Weight Capacity: 20 lbs.

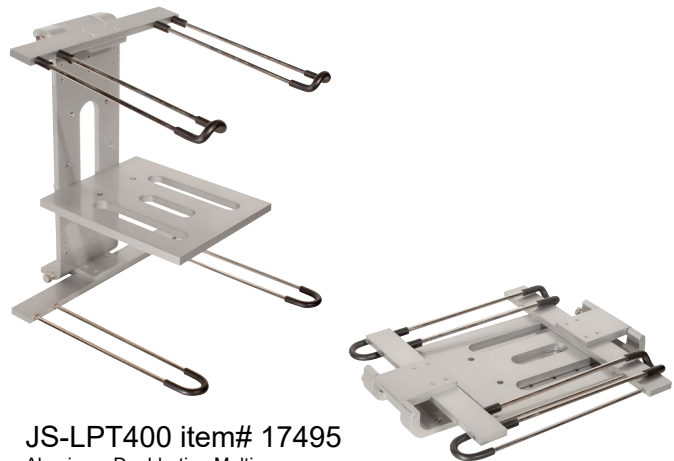

JS-LPT400 item# 17495
Aluminum Double-tier, Multi-purpose Laptop/DJ Stand

JS-LPT400 Features:

- Multi-purpose stand: laptop, lighting controller, small mixer, CD player, DJ equipment, etc.
- Vented second tier
- Folds down for easy and convenient transport and storage
- Weight Capacity: 20 lbs.



DOUBLE-TIER LAPTOP STAND JS-LPT200

Multi-purpose stand: laptops, lighting controller, small mixer, CD player, DJ equipment, etc.

Vented accessory platform included to hold hard drives, USB hubs, audio interfaces, and more

Five height positions

Three width positions

Weight Capacity: 20 lbs.



JS-LPT200 item# 17359
Double-tier, Multi-purpose Laptop/DJ Stand

JS-LPT200 Features:

- Multi-purpose stand: laptop, lighting controller, small mixer, CD player, DJ equipment, etc.
- Vented accessory platform
- Five height positions & three width positions
- Weight Capacity: 20 lbs.

LAPTOP STAND WITH MULTI-USE SURFACE CLAMPS JS-LPT100

Multi-purpose stand: laptops, lighting controller, small mixer, CD player, DJ equipment, etc.

Vented second tier included to hold hard drives, USB hubs, audio interfaces, and more

Lightweight aluminum construction

Folds down for easy and convenient transport and storage

Weight Capacity: 20 lbs.



JS-LPT100 item# 17358
Tripod Mic Stand

JS-LPT100 Features:

- Multi-purpose stand: laptops, lighting controller, small mixer, CD player, DJ equipment, etc.
- Horizontal and vertical clamps included!
- Five height positions & three width positions
- Weight Capacity: 20 lbs.





UNIVERSAL IPAD HOLDER JS-MNT101

- Securely holds most standard tablet sizes
- Connects to microphone stand pole
- Highly adjustable to suit viewing needs
- Secures in portrait or landscape view



JS-MNT101 item# 18009
Universal Tablet Holder

JS-MNT101 Features:

- Securely holds all iPads including iPad mini
- Connects to microphone stand pole
- Highly adjustable to suit viewing needs
- Secures in portrait or landscape view



**STOP DREAMING.
START DOING.**



KEYBOARD STANDS



DOUBLE-BRACED KEYBOARD STANDS JS-502D

Double-braced for heavier keyboards

Five height positions

Easy-to-adjust pull-style knob locks stand in place

Constructed from strong steel tubing

125 lbs. weight capacity



JS-502D item #17250
Double Brace X-Style Keyboard Stand

JS-502D Features:

- Double-braced for heavier keyboards
- Five height positions
- Easy to adjust pull-style knob
- Constructed from strong steel tubing
- Load capacity: 125 lbs.

SINGLE-BRACED KEYBOARD STANDS JS-500

Assembled single-braced X-style stand

Strong, sturdy steel design

Five height positions

Folds flat for simple storage and transport

Rubber end caps keeps instrument scratch-free

Load capacity: 100 lbs.



JS-500 item #16808

Single Brace X-Style Keyboard Stand
(Assembled)

JS-500 Features:

- Assembled single-braced X-style stand
- Strong, sturdy steel design
- Five height positions
- Folds flat for simple storage and transport
- Load capacity: 100 lbs.



SINGLE-BRACED KEYBOARD STANDS JS-XS300

Double-braced for heavier keyboards

Five height positions

Easy-to-adjust pull-style knob locks stand in place

Constructed from strong steel tubing

125 lbs. weight capacity

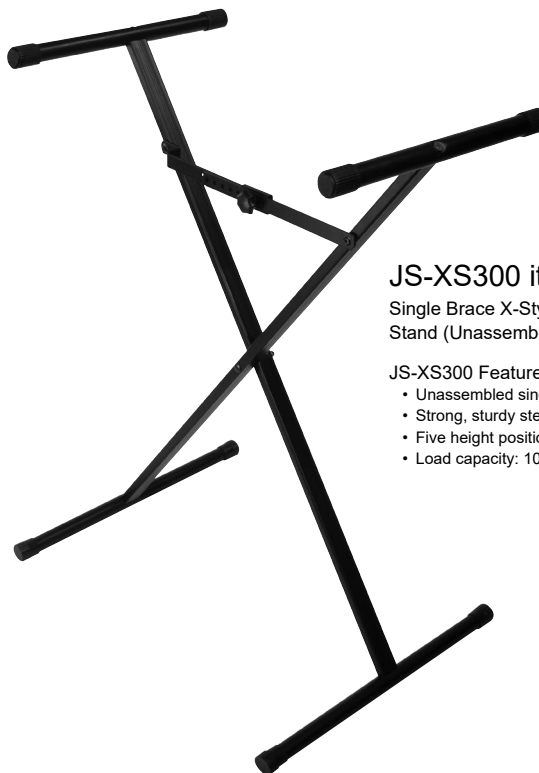

JS-XS300 item #16837

Single Brace X-Style Keyboard Stand (Unassembled)

JS-XS300 Features:

- Unassembled single-braced X-Stand
- Strong, sturdy steel design
- Five height positions
- Load capacity: 100 lbs.

MULTI-PURPOSE KEYBOARD STAND JS-MPS1

Large enough for mixers, keyboards, DJ coffins, and more!

Sturdy, steel design

Height adjustable from 26" to 43"

Width adjustable from 28.75" to 42"



JS-MPS1 item #17252

Multi-purpose Keyboard/Mixer Stand

JS-MPS1 Features:

- Large enough for mixers, keyboards, DJ coffins, and more!
- Sturdy, steel design
- Height adjustable from 26" to 43"
- Width adjustable from 28.75" to 42"
- Load capacity: 110 lbs. (50 kg)



LARGE BENCH JS-XB100-B

JS-XB100-B (Black)
item #18401 (Black)
Large Keyboard Bench

JS-XB100-B & JS-XB100-W Features:

- Adjustable Positions: 4
- Height Range: 22.25" – 18.25"
(565mm – 464mm)
- Seat Thickness: 2.5" (64mm)
- Seat Dimensions: 23.5" x 11.5"
(597mm x 292mm)
- Load Capacity: 300 lbs. (136 kg)
- Weight: 11 lbs. (4.9 kg)



Thick padded seat

Dual-locking pin system with four height positions

Strong steel X-style frame

EXTRA CAPACITY BENCH HOLDS UP TO 300 LBS.



**STOP DREAMING.
START DOING.**





MEDIUM BENCH JS-MB100

Robust X-style steel frame

Large, thick (2") padded seat

**16 Possible Height Configurations
(4 positions on each side)**

Dual-locking secure clutch system

Folds flat for easy storage and transport

JS-MB100
item #16801
Medium Keyboard Bench

- JS-MB100 Features:
- Adjustable Positions: 4
 - Height Range: 18.5" – 22.5"
(470mm – 572mm)
 - Seat Thickness: 2" (51mm)
 - Seat Dimensions: 21" x 9.75"
(533mm x 248mm)
 - Load Capacity: 200 lbs. (90,7 kg)
 - Weight: 9.65 lbs. (4,4 kg)



SMALL BENCH JS-SB100

Robust X-style steel frame

Padded seat for comfort

Three height positions

Perfect bench for students and smaller musicians

JS-SB100
item #17184
Small Keyboard Bench

- JS-SB100 Features:
- Adjustable Positions: 3
 - Height Range: 18" – 19.5"
(457mm x 495mm)
 - Seat Thickness: 1" (25,4 kg)
 - Seat Dimensions: 16.5" x 12"
(419mm x 305mm)
 - Load Capacity: 200 lbs. (90,7 kg)
 - Weight: 6.85 lbs. (3,1 kg)





MICROPHONE STANDS



TRIPOD MIC STAND WITH TELESCOPING BOOM JS-MCTB200

**Telescoping boom arm adjusts from
19.5" to 34.5"**

Strong, reliable tripod base

Metal die-cast housing

Standard 5/8" threading

Non-slip rubber feet

Strong, tip-resistant tripod base



JS-MCTB200 item# 16792

**Tripod Microphone Stand with
Telescoping Boom**

JS-MCTB200 Features:

- Telescoping boom arm adjusts from 19.5" to 34.5"
- Scratch-resistant powder coat finish
- Metal die-cast housing
- Standard 5/8" threading
- Strong, tip-resistant tripod base

TRIPOD MIC STAND WITH FIXED BOOM JS-MCFB100

**31.5" Fixed-length boom arm for
precise positioning**

Strong, tip-resistant tripod base

Scratch-resistant powder coat finish

**Die-cast leg housing for dependable
base support**

Non-slip rubber feet



JS-MCFB100 item# 16791

**Tripod Mic Stand with
Fixed-length Boom**

JS-MCFB100 Features:

- 31.5" Fixed-length boom arm
- Strong, tip-resistant tripod base
- Scratch-resistant powder coat finish
- Die-cast leg housing for dependable base support
- Non-slip rubber feet



TRIPOD MIC STAND JS-MC100

Height adjustable to fit various needs

Strong, tip-resistant tripod base

Scratch-resistant, powder-coated black finish

Die-cast leg housing for dependable base support



JS-MC100 item# 16807
Tripod Mic Stand

- JS-MC100 Features:**
- Height adjustable
 - Strong, tip-resistant tripod base
 - Scratch-resistant, powder coated finish
 - Die-cast leg housing for dependable base support

6-PACK TRIPOD MIC STAND BUNDLE JS-MCFB6PK

Six (6) tripod microphone stands

Each stand features a non-detachable 31" boom arm

Handy carrying bag included for FREE!

Standard 5/8" threading

Non-slip rubber feet

Strong, tip-resistant tripod base



JS-MCFB6PK item# 17461
6-Pack Tripod Mic Stand Bundle

- JS-MCFB6PK Features:**
- Six (6) tripod mic stands
 - 31" fixed-length boom arms
 - Carrying bag included for FREE!
 - Standard 5/8" threading



SMALL TRIPOD MIC STAND WITH TELESCOPING BOOM JS-MCTB50

Telescoping boom arm adjusts from 16.5" to 29"

Metal die-cast housing

Standard 5/8" threading

Short height for hard-to-get-to spaces

Non-slip rubber feet

Strong, tip-resistant tripod base

SMALL TRIPOD MIC STAND WITH FIXED JS-MCTB50

24" Fixed-length boom arm

Metal die-cast housing

Standard 5/8" threading

Short height for hard-to-get-to spaces

Non-slip rubber feet

Strong, tip-resistant tripod base

JS-MCTB50 item# 16796
Short Mic Stand with Telescoping Boom

JS-MCTB50 Features:

- Telescoping boom arm adjusts from 16.5" to 29"
- Metal die-cast housing
- Standard 5/8" threading
- Short height for hard-to-get-to spaces
- Strong, tip-resistant tripod base



JS-MCFB50 item# 16795
Short Mic Stand with Fixed-length Boom

JS-MCFB50 Features:

- 24" Fixed-length boom arm
- Metal die-cast housing
- Standard 5/8" threading
- Short height for hard-to-get-to spaces
- Strong, tip-resistant tripod base





ROUND BASED MIC STAND JS-MCRB100

- Heavy die-cast traditional round base
- Heavy-duty steel construction
- Height adjustable to fit various needs
- Scratch-resistant, powder-coated black finish



JS-MCRB100 item# 16793
Round Base Mic Stand

- JS-MCRB100 Features:
- Heavy die-cast traditional round base
 - Heavy-duty steel construction
 - Standard 5/8" threading
 - Height adjustable to fit various needs
 - Scratch-resistant, powder-coated black finish

MIC BOOMS

- Standard 5/8" threading
- Comfortable adjustment dial and knob
- Cable management clip included
- Metal housing for superior durability

JS-TB100 item #16798
Telescoping Microphone Boom Arm

- JS-TB100 Features:
- 19.5" to 34.5" adjustable telescoping mic boom arm
 - Standard 5/8" threading
 - Comfortable adjustment dial and knob
 - Cable management clip included

JS-FB100 item #16797
Fixed-Length Microphone Boom Arm

- JS-FB100 Features:
- 32.5" fixed-length, adjustable mic boom arm
 - Standard 5/8" threading
 - Comfortable adjustment dial and knob
 - Cable management clip included
 - Metal housing for superior durability





**KICK DRUM/GUITAR
AMP MIC STAND
JS-KD55**

- Low-profile mic stand for tight spaces**
- Heavy-duty die-cast base**
- Angle-adjustable base for precise positioning**
- Fixed boom arm provides even greater flexibility**



JS-KD55 item# 17451
Angle-adjustable Kick Drum/Guitar Amp Stand

- JS-KD55 Features:**
- Low-profile mic stand for tight spaces
 - Heavy-duty die-cast base
 - Angle-adjustable base for precise positioning
 - Fixed boom arm provides even greater flexibility



**KICK DRUM/GUITAR
AMP MIC STAND
JS-KD50**

- Low-profile mic stand for kick drums and guitar amps**
- Heavy-duty die-cast base**
- Fixed boom arm provides precise positioning**
- Scratch-resisitant, powder-coated black finish**
- Standard 5/8" threading**

JS-KD50 item# 17231
Kick Drum/Guitar Amp Mic Stand

- JS-KD50 Features:**
- Low-profile mic stand for kick drums and guitar amps
 - Heavy-duty die-cast base
 - Strong, durable steel construction
 - Fixed-length boom arm





WEIGHTED BASE DESKTOP MICROPHONE STAND JS-DMS50

Low-profile mic stand for tight spaces

Heavy-duty die-cast base

Angle-adjustable base for precise positioning

Fixed boom arm provides even greater flexibility

JS-DMS50 item# 17310
Desktop Round Base Microphone Stand

- JS-DMS50 Features:
- Height adjustable from 8" to 12.25"
 - Scratch-resistant, powder coated black finish
 - Non-slip rubber ring on bottom of base
 - Solid die-cast round base



GOOSENECK DESKTOP MICROPHONE STAND JS-DMS75

Low-profile mic stand for kick drums and guitar amps

Heavy-duty die-cast base

Fixed boom arm provides precise positioning

Scratch-resistant, powder-coated black finish

Standard 5/8" threading

JS-DMS75 item# 17311
Desktop Round Base / Gooseneck Microphone Stand

- JS-DMS75 Features:
- Adjust microphone position quickly and easily with gooseneck shaft
 - Scratch-resistant, powder coated black finish
 - Non-slip rubber ring on bottom of base
 - Solid die-cast round base





**MINI TRIPOD DESKTOP
MICROPHONE STAND
JS-MMS1**

JS-MMS1 item# 17259
Mini Desktop Tripod Mic Stand

- JS-MMS1 Features:**
- Small, durable desktop mic stand
 - Microphone clip included
 - Perfect for desktop recording and iPod casting
 - Scratch-resistant powder-coated finish
 - Tripod base for stability



**FITS IN YOUR
HAND**

- Small, durable desktop mic stand**
- Microphone clip included**
- Perfect for desktop recording and iPod casting**
- Scratch-resistant powder-coated finish**
- Tripod base for stability**

MICROPHONE ACCESSORIES

JS-GN6 item# 17253
JS-GN13 item# 17254
JS-GN19 item# 17255

Sometimes you need a little flexibility when it comes to mic placement, and that's where the gooseneck comes in! Available in 6", 13", and 19" lengths, there's always a gooseneck that's perfect for your situation.

JS-MC1
item# 17233
Clothespin-style
Spring-loaded
Microphone Clip
with 5/8" Thread



JS-MC3
item# 17243
Traditional
Microphone Clip
with 5/8" Thread



JS-MC9
item# 17237
Heavy-duty
Rubber, Smaller
Microphone Clip
with 5/8" Thread



JS-GN6



JS-GN13



JS-GN19



GUITAR STANDS



TUBULAR GUITAR STAND JS-TG101

JS-TG101 item# 16786
Tubular Guitar Stand

JS-TG101 Features:

- Steel tube stand for electric or acoustic guitars
- Durable powder-coated black finish
- Protective rubber at contact surfaces
- Rubber feet ensures your guitars won't move on stage

Steel tube stand for electric or acoustic guitars

Durable powder-coated black finish

Protective rubber at contact surfaces

Adjustable from 23.75" to 28"

Yoke folds down for easy storage and transport



DOUBLE HANGING GUITAR STAND JS-HG102

JS-HG102 item #17232
Double Hanging-Style Guitar Stand

JS-HG102 Features:

- Safely holds two electric, acoustic, or bass guitars
- Easy-to-use safety gate secures headstock
- Strong, durable steel construction
- Protective rubber at contact surfaces
- Ergonomic "Z" knob enables easy height adjustment
- Rubber feet ensures your guitars won't move on stage

Safely holds two electric, acoustic, or bass guitars

Easy-to-use safety gate secures headstock

Strong, durable steel construction

Protective rubber at contact surfaces

Ergonomic "Z" knob enables easy height adjustment

Rubber feet ensures your guitars won't move on stage





TRIPLE HANGING GUITAR STAND JS-HG102

JS-HG103 item #17246
Triple Hanging-style Guitar Stand

JS-HG103 Features:

- Safely holds three electric, acoustic, or bass guitars
- Easy-to-use safety gate secures headstock
- Strong, durable steel construction
- Protective rubber at contact surfaces
- Ergonomic "Z" knob enables easy height adjustment
- Rubber feet ensures your guitars won't move on stage



Safely holds three electric, acoustic, or bass guitars

Easy-to-use safety gate secures headstock

Strong, durable steel construction

Protective rubber at contact surfaces

Ergonomic "Z" knob enables easy height adjustment

Rubber feet ensures your guitars won't move on stage

A-FRAME GUITAR STAND JS-AG100

JS-AG100 item# 16785
A-frame Guitar Stand

JS-AG100 Features:

- Heavy-duty steel frame holds electric and acoustic guitars
- Folds flat for convenient transport
- Three width settings
- Protective rubber at contact surfaces



Heavy-duty steel frame holds electric and acoustic guitars

Folds flat for convenient transport

Three width settings

Protective rubber at contact surfaces



A-FRAME WIRE GUITAR STAND JS-AG75

Heavy-duty steel stand securely holds both electric and acoustic guitars

Folds flat for convenient transport or storage

Protective rubber at contact surfaces

Five width settings to accommodate different sized instruments

JS-AG75 item# 17354
A-Frame Wire Guitar Stand

JS-AG75 Features:

- Folds flat for convenient transport or storage
- Protective rubber at contact surfaces
- Five width settings to accommodate different sized instruments



GUITAR HANGER JS-GHG25

Securely holds electric, acoustic, or bass guitars

Wall mount hardware included

Constructed of strong steel

Soft, black rubber padding

Yoke rotates to accommodate various headstock designs

JS-GHG25 item #18008
Electric, Acoustic, and Bass Guitar Hanger with Adjustable Yoke

JS-GHG25 Features:

- Securely holds electric, acoustic, or bass guitars
- Wall mount hardware included
- Constructed of strong steel
- Soft, black rubber padding
- Yoke rotates to accommodate various headstock designs





SMALL PEDALBOARD JS-PB200

Ergonomic small pedalboard

Included soft case features inner mesh pocket

Cable ports for organization and powered connection

Built-in adjustable power supply clamp

JS-PB200 item #17986

Small Pedalboard

JS-PB200 Features:

- Pedal Surface Depth: 8.5"
- Front Height: 1.5"
- Rear Height: 3.25"
- Width: 15.75"
- Cable Port Width: .75"
- Pedal Surface Area: 149.62 sq. in.
- Weight: 3.6lbs.



GUITAR AMP STAND JS-AS100

Five optimized height options with locking pins

Sturdy A-frame design with locking cross brace

Legs fold flat & arms release for easy storage & transport

Load capacity: 150 lbs.

JS-AS100 item #16790

Guitar Amp Stand

JS-AS100 Features:

- Five optimized height options with locking pins
- Sturdy A-frame design with locking cross brace.
- Legs fold flat and arms release for easy storage and transport.
- Load capacity: 150 lbs.





MUSIC PERFORMANCE
CHAIR
JS-MPF100

JS-MPF100 item #17980

Music Performance Chair

JS-MPF100 Features:

- Seat height: 21.75" – 30.75" (552mm - 781mm)
- Backrest Depth: 2 Positions
- Backrest Height: 4 Positions
- Seat Padding Thickness: 2.25" (57mm)
- Backrest Padding Thickness: 1" (25mm)
- Load Capacity: 300 lbs. (136kg)
- Weight: 16lbs. (7,2 kg)



Fully adjustable music performance chair

Thick and comfortable padding on backrest and seat

Quick and easy setup and teardown

Convenient footrest with grip

Holds up to 300 lbs

GUITAR
FOOT STOOL
JS-FT100

JS-FT100B item #16789

Guitar Foot Stool

JS-FT100B Features:

- Adjustable height with three fixed height positions
- Non-slip rubber pads and end caps
- Folds flat for convenient storage



Adjustable height with 4 fixed height positions

Non-slip rubber pad and end caps

Folds flat for convenient storage

Ideal for classical guitarists



SPEAKER STANDS



PAIR OF TRIPOD SPEAKER STANDS

Long-lasting aluminum construction

Durable powder-coated finish

Tripod base is very stable and sturdy

Stand is height-adjustable

Carrying bag included

Holds up to 120 lbs.

Height 46.5" - 81.5"

JS-TS50-2 item# 17318
Pair of Tripod Speaker Stands with
FREE CARRYING BAG

JS-TS50-2 Features:

- Long-lasting aluminum construction
- Durable powder-coated finish
- Tripod base is very stable and sturdy
- Stand is height-adjustable
- Carrying bag included for FREE!
- Holds up to 120 lbs.
- Height 46.5" - 81.5"



SPEAKER POLE

Heavy-duty construction

Height adjustable from 31.5" to 52.5"

Friction locking knob with security pin

1 3/8" upper and lower tubes

JS-SP50 item# 17509
Adjustable Subwoofer Pole

JS-SP50 Features:

- Heavy-duty construction
- Height adjustable from 31.5" to 52.5"
- Friction locking knob with security pin
- 1 3/8" upper and lower tubes





MUSIC STANDS



ALLEGRO MUSIC STANDS

Compact, portable sheet music stand

Height-adjustable telescoping tripod stand

Two telescoping tubes

Angle-adjustable sheet music platform

Two sheet music security arms to hold music in place

JS-MS200 item# 16794
Allegro Tripod Music Stand

JS-MS200 Features:

- Long-lasting steel design
- Angle-adjustable sheet music platform
- Height adjustable from 38" to 57"
- Non-slip rubber feet
- Strong, tip-resistant tripod base



COMPACT MUSIC STANDS

Long-lasting steel design

Angle-adjustable sheet music platform

Height adjustable from 38" to 57"

Non-slip rubber feet

Strong, tip-resistant tripod base

JS-CMS100 item# 16803
Compact Music Stand

JS-CMS100 Features:

- Compact, portable sheet music stand
- Height-adjustable telescoping tripod stand
- Two telescoping tubes
- Angle-adjustable sheet music platform
- Two sheet music security arms to hold music in place



EQUIPMENT CARTS

MEDIUM EQUIPMENT CART

Medium sized Karma Cart

Easily transforms into eight different configurations

Transport your PA system, guitars, DJ equipment, and more

Wheels are made of a solid material that will not go flat

Locking front caster for secure loading and unloading

Strong, light-weight steel design that is powder coated for protection

Easy to fold up for convenient transport and storage

Weight capacity of 300 lbs.

JS-KC90 item# 17436

Karma Cart Adjustable Professional
Equipment Cart - Medium Size

JS-KC90 Features:

- Medium sized Karma Cart
- Easily transforms into eight different configurations
- Transport your PA system, guitars, DJ equipment, and more
- Weight capacity of 300 lbs.

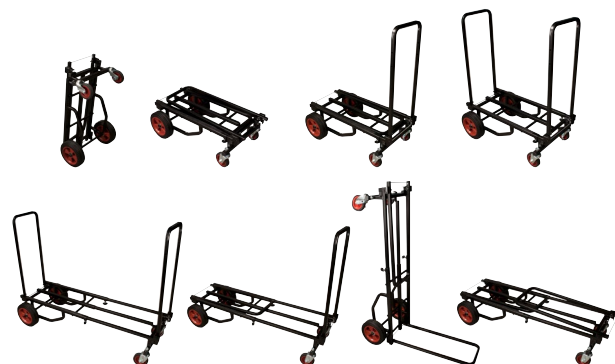

SMALL EQUIPMENT CART

Small sized Karma Cart

Easily transforms into eight different configurations

Transport your PA system, guitars, DJ equipment, and more

Wheels are made of a solid material that will not go flat

Locking front caster for secure loading and unloading

Strong, light-weight steel design that is powder coated for protection

Easy to fold up for convenient transport and storage

Weight capacity of 200 lbs.

JS-KC80 item# 17437

Karma Cart Adjustable Professional
Equipment Cart - Small Size

JS-KC80 Features:

- Small sized Karma Cart
- Easily transforms into eight different configurations
- Transport your PA system, guitars, DJ equipment, and more
- Weight capacity of 200 lbs.



JAMSTANDS®

By Ultimate Support

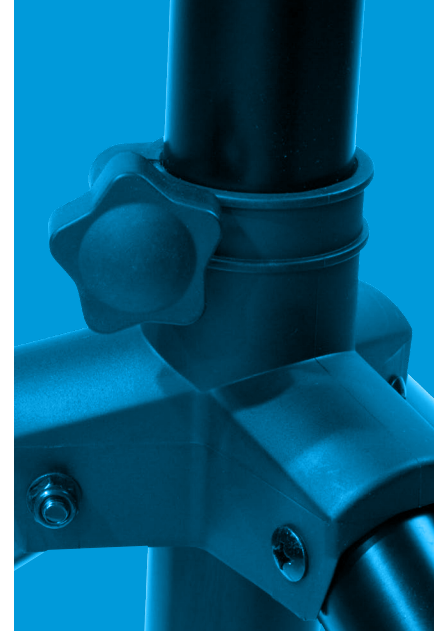

20
21

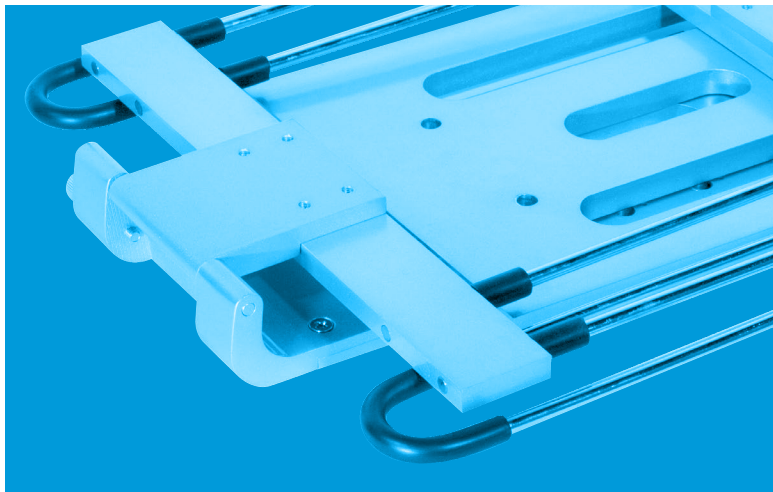

ULTIMATESUPPORT.COM
800.525.5628