

PACON 4800

on-line water hardness analyzer

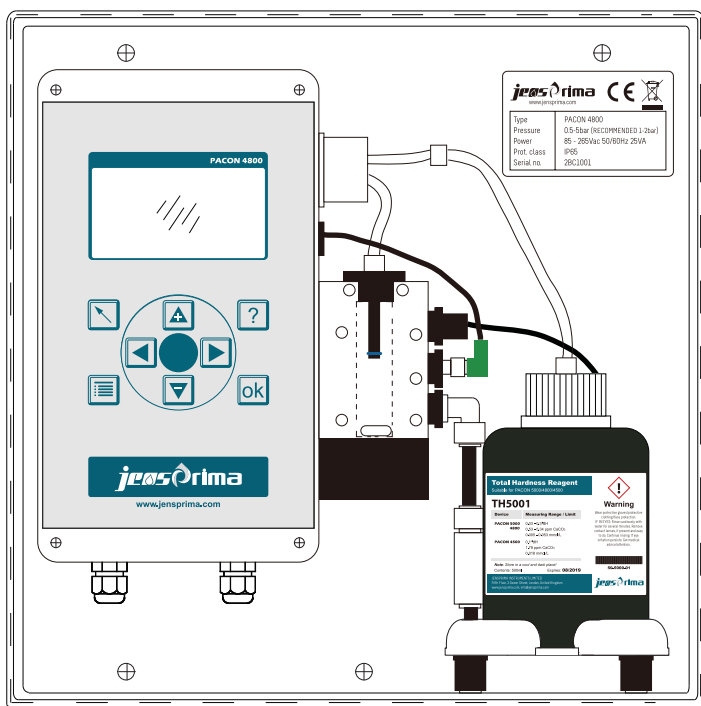

JENSPRIMA INSTRUMENTS LIMITED

1	INTRODUCTION	1
2	PACON 4800 AT A GLANCE	2
3	UNIT DESCRIPTION	3
3.1	PRINCIPLE OF FUNCTION	3
3.2	UNIT OVERVIEW	3
3.3	SCOPE OF DELIVERY	4
3.4	SPECIFICATIONS AND SCOPE OF APPLICATION	5
3.5	INSTALLATION REQUIREMENTS	8
3.6	MAINTENANCE SETS	9
4	GENERAL SAFETY	10
5	INSTALLATION	14
5.1	WALL MOUNTING WITHOUT HOUSING	错误! 未定义书签。
5.2	WALL MOUNTING WITH HOUSING	14
5.3	WATER CONNECTIONS	15
5.4	OPERATING WITH PRESSURE-LESS SAMPLE WATER	16
6	ELECTRICAL INSTALLATION	16
6.1	CONNECTING THE SUPPLY VOLTAGE	17
6.2	CONNECTING THE RELAY OUTPUTS	18
6.3	CONNECTING THE CURRENT INTERFACE AND DIGITAL INPUTS	19
7	COMPONENTS	20
7.1	LOCATION OF COMPONENTS	20
7.2	DISPLAY AND KEYBOARD	23
8	CONNECTING ADDITIONAL COMPONENTS	29
8.1	CONNECTING A FLOW SWITCH	30
8.2	CONNECTING A SWITCH "ANALYSIS START"	31
8.3	CONNECTING A BUZZER / INDICATOR LIGHT	32
8.4	CONNECTING A CONTROL UNIT FOR A REGENERATION UNIT	32
8.5	CONNECTING AN ANALOGUE MEASURING DEVICE	33
9	CONFIGURATION	33
9.1	WORKS SETTINGS	33
9.2	CONFIGURATION ASSISTANT	34
10	OPERATION	41
10.1	MENU STRUCTURE	42
10.2	ACTION IN EVENT OF POWER LOSS	43
10.3	SD-CARD	43
11	MAINTENANCE AND SERVICE	45
11.1	CLEANING THE MEASURING CHAMBER	45
11.2	CHANGING THE DOSING-PUMP-CASSETTE	46
11.3	CHANGING THE REAGENT BOTTLE	47
11.4	CALIBRATING THE UNIT	48
11.5	CHANGING THE BATTERY	48
11.6	SOFTWARE UPDATE	49

12	ERROR ANALYSIS	50
12.1	FAULT FINDING.....	50
12.2	DIAGNOSIS FUNCTION.....	51
13	SPARE PARTS	54
14	MEASUREMENT RANGE OF OUR REAGENTS	56
14.1	REAGENTS FOR ASCERTAINING THE TOTAL HARDNESS	56
14.2	REAGENTS FOR ASCERTAINING THE CARBONATE HARDNESS (ALKALINITY).....	56
15	CALCULATION TABLE FOR COMMON UNITS OF WATER HARDNESS	57
16	INSTRUCTIONS FOR DISPOSAL	57

1 Introduction

Thank you for buying the **PACON 4800** from the product range **PACON** on-line analyzers.

The **PACON 4800** is one of the most modern devices on the market and sets new standards:

- Simply to operate
- Quick commissioning via menu
- Easy maintenance and cleaning
- Intelligent measuring-chamber design
- High measuring accuracy
- Self-calibrating

The **PACON 4800** for the monitoring of water quality is part of a water preparation system. This manual is intended for both, manufacturers and operators of this kind of equipment.

This manual contains instructions for the use and operation of the **PACON 4800**. Please read these instructions carefully before operating the unit.

We recommend to keep this manual next to the unit for quick reference, although we have taken every effort to make the unit, as far as possible, self explanatory in its operation.

The unit should only be operated in accordance with the instructions in this manual.

We will not accept any liability for damage caused by operator errors or failure due to the instructions found in this manual.

Some details and instructions in this manual may vary slightly from the delivered unit. We reserve the right to make technical changes to improve our products without prior notice.

The **PACON 4800** is an on-line analyzer that automatically recognizes and warns of the increase in water hardness in a water preparation system. When used with a water-grading system, the **PACON 4800** monitors the mixed water and reports if it is out of tolerance.

This is not a system to prevent increase in water hardness.

2 PACON 4800 at a glance

The on-line analyser **PACON 4800** has the following features:

- ✓ Reliable, exact and fully automatic analysing unit with matching reagents for measuring the total hardness in the range 0.214 – 534 ppm CaCO₃ (0.012 - 30 °dH) as well as carbonate hardness in the range 5.34 – 374 ppm CaCO₃ (0.3 – 21 °dH)
- ✓ Measurement of all parameters with one sensor
- ✓ Simple commissioning with configuration assistant
- ✓ BOB-Operation(72h)
- ✓ Self calibrating and self monitoring
- ✓ High measuring accuracy
- ✓ Easy maintenance and cleaning
- ✓ Compact design 300x300x140mm
- ✓ Multi-coloured and multi-lingual graphic display
- ✓ 2 relay outputs
- ✓ Analogue output 0/4-20mA
- ✓ Programmable digital input
- ✓ External operation by means of external controller
- ✓ Monitoring of limit value
- ✓ No condensation
- ✓ Software updates by means of SD-card possible
- ✓ History of measured values on SD-card
- ✓ History of last 100 values on LCD
- ✓ Open wall mounting or wall mounting in protective housing (optional)
- ✓ Supply voltage 100-240 Vac, 50/60 Hz

3 Unit description

The on-line hardness monitor **PACON 4800** is a compact analysis device which is able to monitor the presence of various chemicals in water. In these instructions, only the on-line monitoring of total hardness and carbonate hardness is described.

3.1 Principle of Function

The **PACON 4800** is an on-line analyser for the automatic monitoring of water parameters by the colorimetric test method. Following the introduction of areagent into the water sample, a colour reaction occurs. Depending on the chosen method, the unit either evaluates the *intensity* of the colour or ascertains the *value* at which the colour changes. From this information the **PACON 4800** calculates the concentration of the chemical content. The unit can only monitor one parameter. The method and the measurement range are determined by the reagent.

3.2 Unit overview

The **PACON 4800** has two variants:

1. Analysis unit on wall mounting

The analyzer consists of a control unit and a measuring chamber. Both are mounted on a wall mounting plate. This variation is completely functional and includes the connections for the water inlets and outlets as well as the holder for the reagent bottle. (Fig. 1)

2. Analysis unit in protective housing

In addition, an optional plastic housing is available to protect the unit in environments where extreme levels of dirt and grease are expected. (Fig. 2) The analyzer on the wall mounting plate is easily fixed in the protective housing by 4 screws. If the analysis unit and the protective housing are ordered together, they will be delivered assembled.

The analyzer is operated by means of a menu, a graphic display and 6 keys on the control panel.

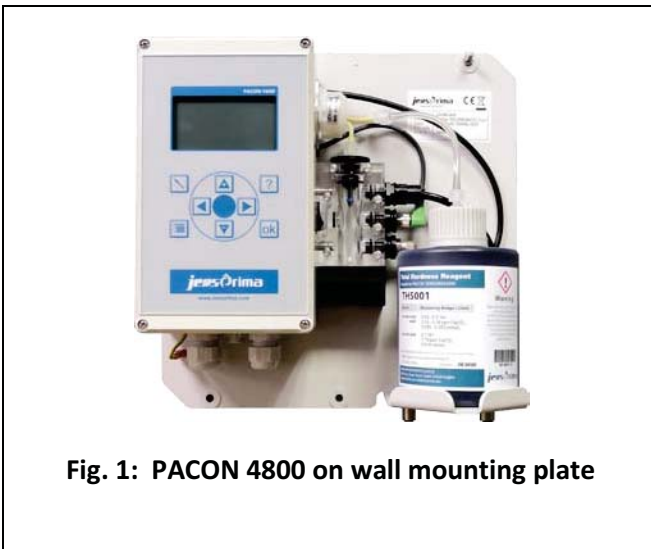

Fig. 1: PACON 4800 on wall mounting plate



Fig. 2: PACON 4800 on wall mounting plate in protective housing

Description	Article number
PACON 4800 PACON 4800 on wall mounting plate 230V version	33-4800-00
Housing for PACON 4800	33-5000-50

3.3 Scope of delivery

The analyser is delivered completely pre-configured and ready for connection. Before installation, please check that all components are existing and correct.

If you order the analyser on a mounting plate, you will receive the following components:

Description	Article number
Basic unit on mounting plate	33-4800-00
Operating Instructions (English)	

If a housing is ordered:

Description	Article number
Housing for PACON 4800	33-5000-50

3.4 Specifications and Scope of Application

General Specification

Supply Voltage	110 - 240 Vac (50/60 Hz)	
Power consumption	25 VA (in operation)	3.5 VA (stand by)
Protection class	Open wall mounting IP54 Mounting in housing IP 65	
Storage temperature	0°C – 40°C without water Do not leave it for more than 168 hrs. at 60°C (140°F) Should not be left for more than 48hrs. at -20°C. (-4°F)	
Environmental temperature	10°C – 40°C (50°F - 104°F)	
Measuring water temperature	5°C – 40°C(41°F - 104°F)	
Humidity	20 -90 % RF(without ice or condensation)	
Water inlet pressure	ca. 0.5 - 5 bar (max.) (Recommended 1–2bar) ca. 7.25 – 72.5psi (max.) (Recommended 14.5 – 29 psi)	
Water inlet in general	clear, colourless, free of solid particles, without any gas bubbles	
Requirements of the water quality during measurement of the water hardness	pH:	4 – 10
	Iron:	< 3 ppm
	Copper:	< 0.2 ppm,
	Aluminium:	< 0.1 ppm
	Manganese:	< 0.2 ppm
	Acid capacity:	KS 4.3 < 5mmol/l

Technical Data

Installation	Wall mounting in closed rooms	
Dimensions	Without housing:	274x275x130 mm (WxHxD)
	With housing:	330x300x185 mm (WxHxD)
Weight	Without housing:	Approx..1.9 kg
	With housing:	Approx. 3.7 kg

Analysis Qualities

Measurement method	titration method with colour change			
Measurement range	Total hardness		Carbonate hardness Alkalinity	
	ppm CaCO ₃	0.36 to 534	ppm CaCO ₃	5.34 to 374
	°dH	0.02 to 30	°dH	0.3 to 21
	°f	0.04 to 534	°f	0.534 to 37.4
	°e	0.03 to 37.6	°e	0.376 to 26.3
	mmol/l	0.0036 to 5.34	mmol/l	0.0535 to 3.74
	The measurement range of the unit is defined by the reagent used. The full measurement range of the total hardness from 0.36 to 534 ppm CaCO ₃ is acquired by the application of different reagents.			
Accuracy	<p>Measurement accuracy:</p> <p>+/- 5% of the upper value of the respective reagent</p> <p>Repetition accuracy:</p> <p>+/- 2.5% of the upper value of the respective reagent</p> <p>Please note: The accuracy of the measurements may be adversely affected by the impurity of the water. In such cases, we recommend that you take a hardness measurement by hand titration and then calibrate the analysis unit to this value.</p>			
Reagent consumption	approx. 0.20 ml / analysis depending on the hardness of the water			
Measurement duration	approx. 3 minutes depending on the hardness of the water			
Number of analyses	approx. 10,000 analyses / 500 ml reagent at low hardness. The consumption depends on the measured water hardness and the reagent used.			
Shelf life of reagent	At least 2 years			
Water consumption	<p>approx. 1l/analysis at 2 bar</p> <p>The water consumption varies according to pressure and flush-time.</p>			

Inputs / Outputs

2 Relay outputs	<p>max. 250 Vac / Vdc; 1A</p> <p>as potential free output NC/NO</p> <p>the relays offer the following functions:</p> <ul style="list-style-type: none"> • Threshold alarm • Unit error • Standby
Signal input	<p>Galvanic separated contact input</p> <ul style="list-style-type: none"> • Analysis start • Flow switch
Analogue Output	<p>0 – 20 mA / 4 – 20 mA</p> <p>Resolution: < 100 µA</p> <p>max. working resistance: 750 Ω</p>

Maintenance Intervals

After 6 months	<p>Cleaning of the measurement chamber</p> <p>(In the event of higher environmental / water temperatures or water with higher biotical content, cleaning intervals need to be reduced accordingly.)</p>
After 20,000 analyses or after 24 month of use	<p>Installation of maintenance set.</p>

3.5 Installation requirements

Reagents / Maintenance sets / Accessories

There are various reagents available for the **PACON 4800** that cover a wide range of measurement. When choosing the correct reagent, it is important that the hardness range to be monitored is in the middle of the reagent's measurement range.

Total hardness

Article Reagent	Range			Order-No. 500ml bottle
	°dH	ppm CaCO ₃	°f	
TH5000	0.012 ↔ 0.12	0.224 ↔ 2.13	0,036 ↔ 0,214	50-5000-01
TH5001	0.03 ↔ 0.3	0.543 ↔ 5.43	0,053 ↔ 0,53	50-5001-01
TH5003	0.09 ↔ 0.9	1.6 ↔ 16.0	0,16 ↔ 1,6	50-5003-01
TH5010	0.30 ↔ 3.0	5,34 ↔ 53,4	0,53 ↔ 5,34	50-5010-01
TH5030	0.9 ↔ 9.0	16.0 ↔ 160	1,6 ↔ 16,0	50-5030-01
TH5050	1.5 ↔ 15.0	26.7 ↔ 267	2,7 ↔ 26,7	50-5050-01
TH5100	3.0 ↔ 30.0	53.4 ↔ 534	5,4 ↔ 53,4	50-5100-01

N.B. Indicators TH5030 and above are very temperature sensitive and it may be necessary to correct the test results with reference to the environmental temperature.

Carbonate Hardness (alkalinity)

Article Reagent	Range			Order-No. 500ml bottle
	°dH	ppm CaCO ₃	°f	
TC5010	0.3 ↔ 7.5	5.34 ↔ 134	0.5 ↔ 13.3	50-5510-01
TC5015	0.45 ↔ 11.5	8.0 ↔ 205	0.8 ↔ 20.5	50-5515-01
TC5020	0.6 ↔ 15.0	10.7 ↔ 267	1.1 ↔ 26.7	50-5520-01
TC5030	0.9 ↔ 22.5	16.0 ↔ 401	1.6 ↔ 40.0	50-5530-01



The reagents are available in 500ml bottles. This amount is sufficient for about 10,000 analyses at low hardness for example monitoring of a water softener. The number of analyses depends on the hardness level and the reagent used.

Reagents that are not in use should be stored in a cool, dark place. Avoid direct sunlight. The shelf life of the reagents is at least 24 months if stored below 25°C and in a dark place. High temperatures and direct sunlight may significantly reduce the shelf life!

3.6 Maintenance sets

The analyser does not need much maintenance. A **maintenance set** is available for this analysis unit. It is recommended to change the dosing-pump cassette, the reagent pipes and the 'o'-rings after 50,000 analyses or every 6 months.

It is also recommended that the measuring chamber is regularly cleaned – at least every 6 months.

Article		Order number
<p>Maintenance set for PACON 4800 half-year maintenance</p>		<p>50-500010</p>
<p>Water connection adapter from ½", ¼" to 6mm, including manual valve</p>		<p>50-500050</p>

Pre-cooler

The maximum input temperature of the sample water is 40°C. If the sample water exceeds 40°C, a pre-cooler must be installed. Which of the 2 pre-coolers is recommended depends on the temperature of the sample water and the cooling water.

4 General Safety

Please follow the following safety instructions before operating the unit.

We want to inform about the appropriate use, installation and maintenance of the **PACON 4800** in order to ensure a safe, problem free operation. Please take careful note of the possible dangers that may result from incorrect use. The safety symbols are explained and fundamental instructions are given. The reading of this chapter does not replace technical training. **The installation and commissioning of this unit should only be carried out by authorised and qualified persons.**

This manual describes the installation and the operation of the on-line analyzer **PACON 4800** for the automatic monitoring of water hardness.

This unit may only be used in accordance with the conditions described in this manual. In particular, the unit must be protected from humidity and wetness. The protection class of the unit on a mounting plate is IP43. When mounted in a protective housing, the protection class is IP54. Splashing or condensation should be avoided. The unit may only be used for the specified purpose. During installation and operation of the analysis unit, the relevant regulations (e.g. EN, DIN, VDE, UVV) should be observed.

The analysis unit should only be used to monitor the total water hardness or the carbonate hardness in the sample water. **Correct operation can only be warranted if the manufacturer's recommended reagents and spare parts are used.**

Changes to the electrical wiring and the programmes should only be carried out by a designated and qualified person.

The connecting cables should be kept as short as possible and not laid next to, or in close proximity to, power cables. Analysis may be adversely affected by strong electromagnetic fields. In this case, special protective measures should be applied. Correct earthing is essential.

It is recommended to have these operating instructions at hand during the initial operating of the equipment in order to get an immediate understanding of the functions. Since the various ideas build upon the previous information it makes sense to work through the chapters in their printed order.

If any problems occur or questions arise during the operation of the analysis unit, you can get assistance from your supplier. Try to locate the problem as accurately as possible or to record the action and conditions that lead to the problem. This makes prompt assistance possible.

Safety Instructions and Symbols

In this manual, you will find various safety details that warn of possible dangers associated with the use of the analysis unit. This applies to specific dangers to:

- persons,
- this product or connected equipment and installations,
- working environment.

Various symbols in this manual point out special dangers for the purpose of protecting persons and equipment from injury or damage. Please read the whole text completely before you start working.



Danger

This symbol warns of possible danger of injury.



Warning

This symbol warns of a general risk to the unit, the installation, the materials, the working area and the persons therein.



Pressure

This symbol warns that the parts may be under pressure.



Voltage

This symbol warns of the danger of electrocution as well as damage to electrical parts.



This symbol warns of a general risk and the need to take note of certain conditions.



This symbol is to make the user aware of useful tips to improve the understanding of this unit.

Working with pipes that are under pressure

Maintenance and repair work are only to be carried out by qualified persons.

- Before you start, make sure that there is no pressure in the pipes.
- Pipes, joints and seals are to be checked regularly and where necessary, or as a precautionary measure, replaced. Maintenance intervals should, in any case, be observed.
- Before operating after maintenance, ensure that all joints, fittings and seals are correctly fitted. Check that all casing parts are closed and filters or other parts connected to the unit are correctly fitted.
- Remove all maintenance tools, parts and other materials before operating the system.
- Clean the unit and wipe up any fluids that have run out thereby leaving the unit in a clean condition.
- Check that all safety systems are in position and working.

Transport

Protect the analysis unit during transport. Remove any remaining fluids. Remove the reagent bottle and firmly close it to avoid any spillage.

Transport the unit carefully and do not throw it.

Avoid direct sunlight, moisture and high temperatures.

Immediately after delivery, check that the unit is complete and has no damage. Even though the unit is well packed, damage can occur during transport. In the event of damage, inform the supplier immediately.

Storage

Do not store the analyser for more than a year on account of the guarantee. Only store the analysis unit in a cool, dry place with temperatures between 5 and 45°C and avoid direct sunlight.

Scope of Delivery

Check if all ordered components are existing.

Damage or missing parts are to be reported within 7 days of delivery. Later claims will not be accepted.

Installation

The installation should be carried out in the following order to avoid errors:

- Install the analyser in a dry and easily accessible place.
- Fix it securely according to the mounting instructions.
- Power up the unit with the correct supply voltage as noted on the type label.
- Connect the inlet and outlet pipes according to the installation instructions.
- Insert the reagent bottle and connect it to the dosing pump. Make sure that the pipe is not twisted.
- Set the unit up according to the instructions in the following sections.
- Only switch on the unit when all preparation is done, the case is closed and the unit is set up.

5 Installation

5.1 Wall mounting with housing

The analyser can be delivered with a compact protection housing as an optional extra. The housing is delivered with the unit already mounted inside and 4 mounting brackets for fixing the housing as shown in the drilling plan below:

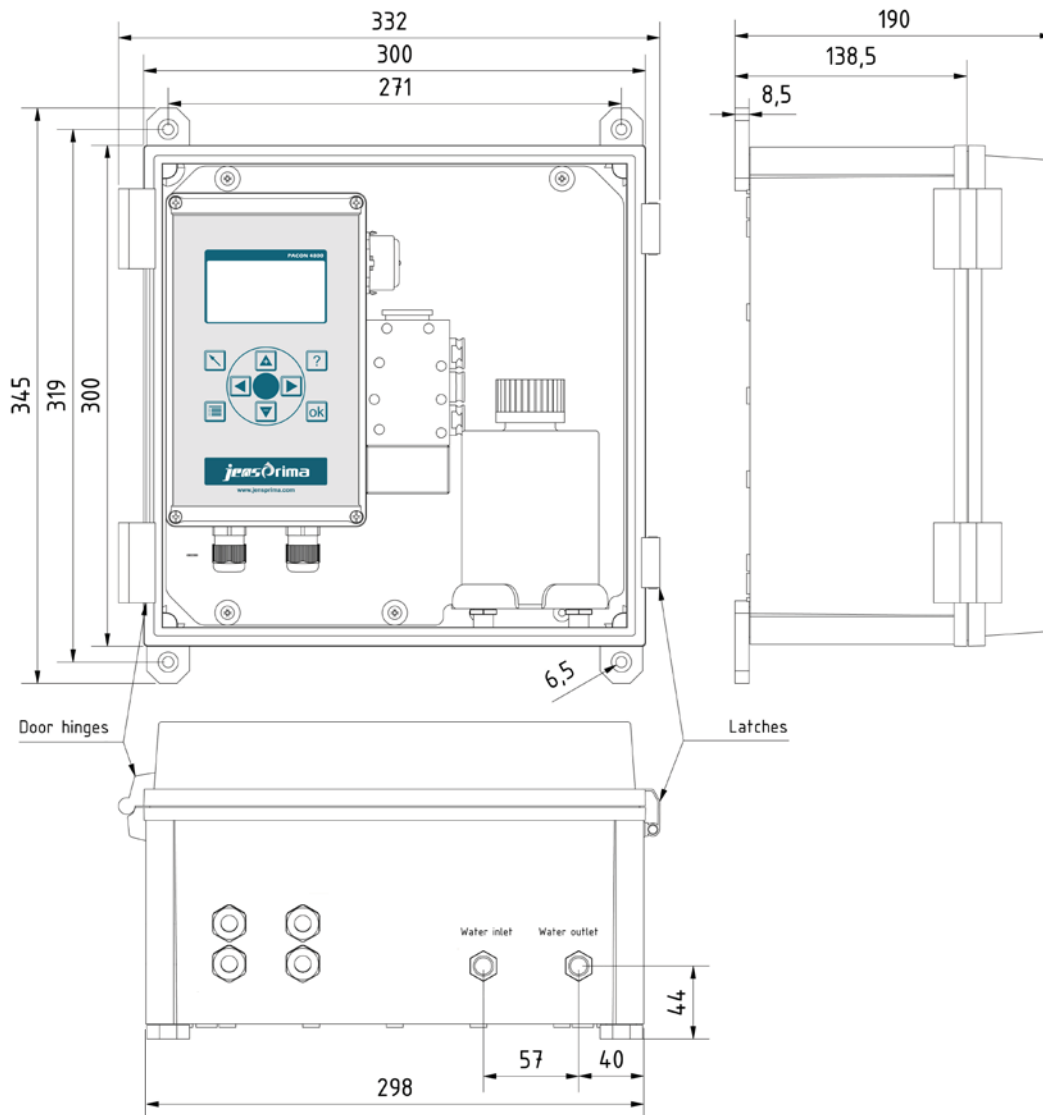

To allow for opening the housing, the designated mounting space must be at least 450x350mm (D xH).

Alternatively, the 4 brackets can be fixed at 45 or 90°. The drawing shows vertical fixing.

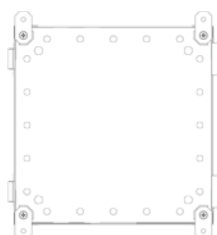

5.2 Water Connections

Although the ideal input pressure for the analysis unit is between 1 and 2 bar, it should never be less than 0.2 bar. In the water inlet pipe there is an input valve which, when closed, allows the measuring chamber to operate without pressure. The unit can also be operated with an input pressure of up to 5 bar. However, when the pressure is released, gassing may occur.

It is recommended to reduce the pressure with a simple valve. A pressure reducer is not necessary.

The sample water must be clear and free of solid particles or a filter has to be installed. Solid particles in the water can damage the magnet valve or prevent it from closing. If the magnet valve is blocked or doesn't open and close properly, the measuring chamber will not be properly flushed and this could lead to erroneous measurements.

The sample water temperature should not be less than 5 °C or higher than 40 °C.

If the sample water has a higher temperature, a pre-cooler should be installed. These coolers are also available from our product range.

The analysis unit has 2 connections with fittings for plastic pipes with an external diameter of 6mm for the water inlet (left) and the water outlet (right). These only need to be pushed into the fittings.

Inlet pressure: ca.
3 – 72.5 psi
(0.2 – 5.0 bar)

Recommended
14.5 – 29 psi
(1 – 2 bar)

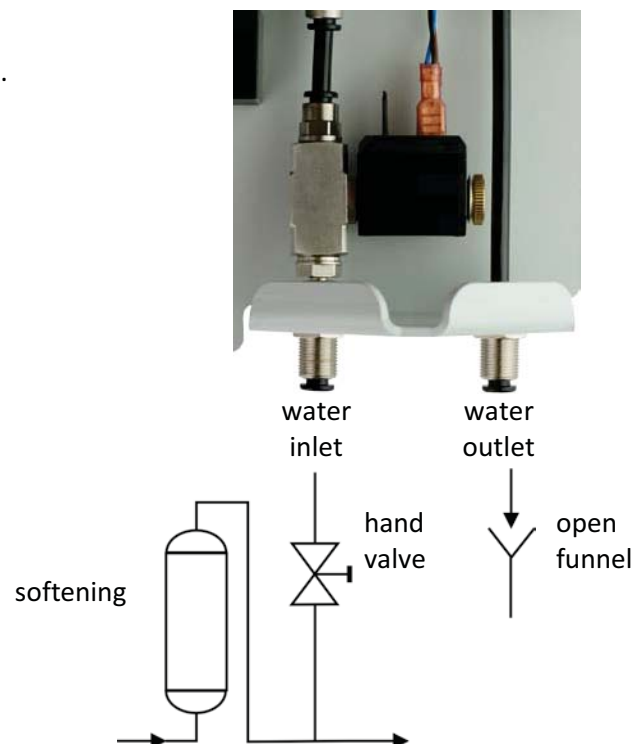

The water outlet should be as short as possible and the water should be able to run away vertically and free. The system output must be at atmospheric pressure. The output pressure must not exceed the input pressure. The pipes should not be laid horizontally. Pipes should not exceed 2m in length. The output water must run into an open funnel or wastewater pipe/drain.

5.3 Operating with pressure-less sample water

If the sample water is not under pressure, a simple membrane or immersion pump is necessary to transport the sample to the analysis unit. Relay 4 can be used for this purpose.

6 Electrical Installation

Please note that all electrical installation work should only be carried out by authorised and qualified personnel and according to current regulations. Make sure that cables are not connected to power.

The required supply voltage is: 110/ 220 / 230 AC power net

Open the lid of the control box

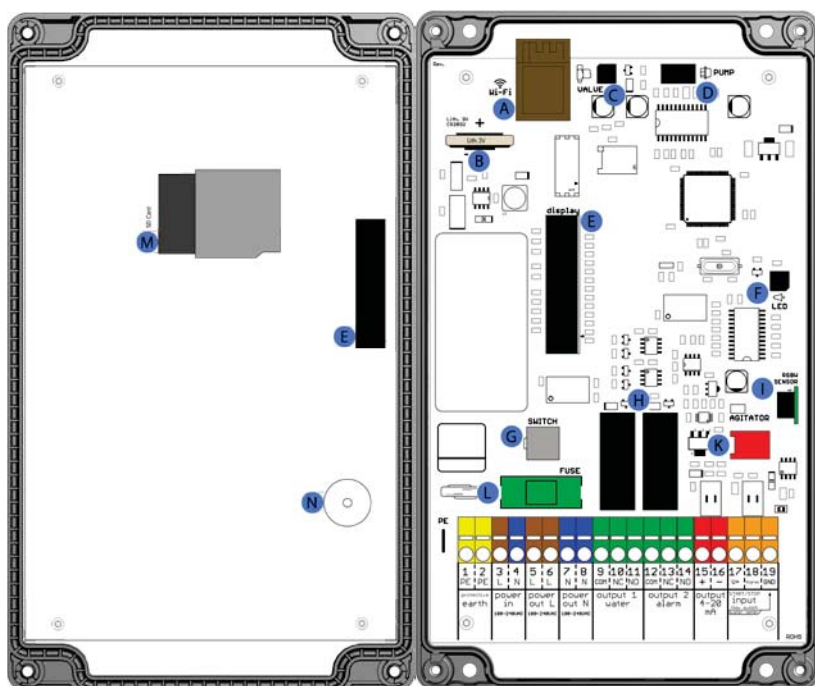

Pos.	Description
A	Wi-Fi (optional)
B	Battery holder
C	Solenoid valve jack
D	Dosing pump jack
E	Display jack
F	Actuator plug (LED) jack
G	Main switch jack
H	2x Relays
I	RGBW Sensor
K	Magnetic stirrer jack
L	Fuse holder
M	SD-card holder
N	Speaker

6.1 Connecting the supply voltage

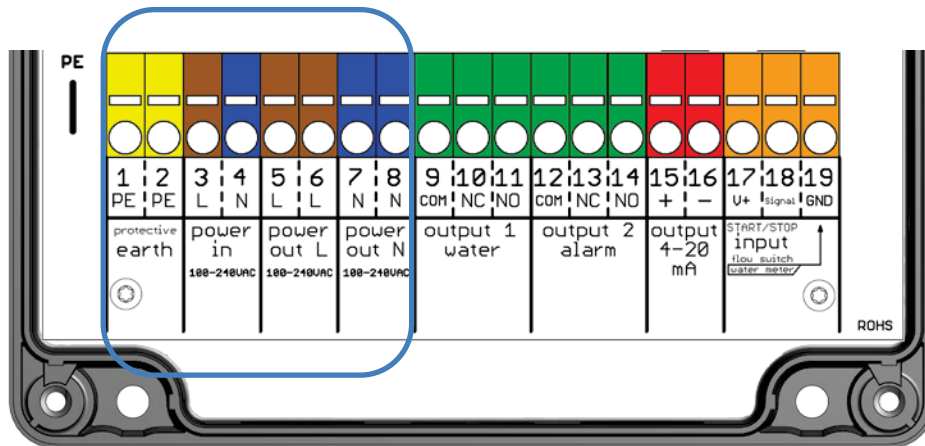

Terminal	Description	Function	Connection
power supply			
1	protective earth	PE	Protective earth
2	protective earth	PE	Protective earth
3	power in L 100-240 VAC	Input Live 100-240 VAC	Live
4	power in N 100-240 VAC	Input Neutral 100-240 VAC	Neutral
output terminals, switched via device switch			
5	power out L 100-240 VAC	Output Live 100-240 VAC	Live
6	power out L 100-240 VAC	Output Live 100-240 VAC	Live
7	power out N 100-240 VAC	Output Neutral 100-240 VAC	Neutral
8	power out N 100-240 VAC	Output Neutral 100-240 VAC	Neutral

Ensure to make a good earth contact to avoid possible malfunctions of the unit.

The mains output appearing on the top row can be used via the output relays to drive pumps, valves or others. The total consumption of all connected appliances must not exceed 500 VA.

6.2 Connecting the relay outputs

In the second terminal block you will find the connections for the 4 output relays. All relays are 2 way changeover types with a common contact and outputs A and B.

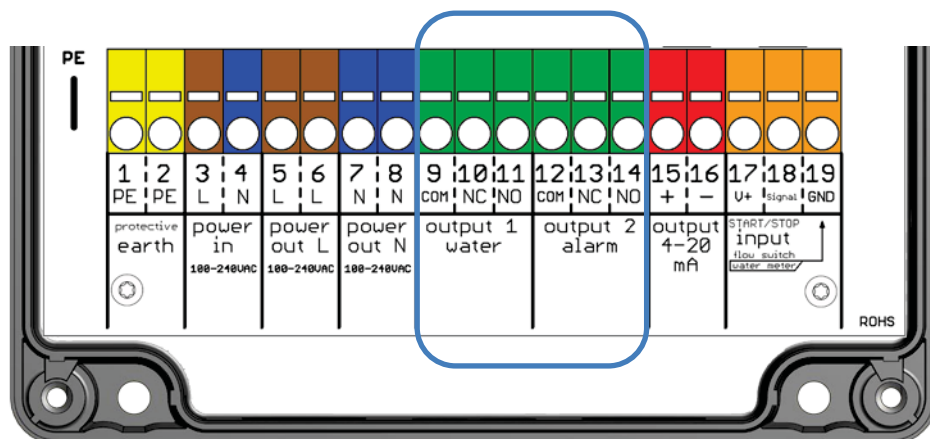

Terminal	Description	Function	Connection
----------	-------------	----------	------------

output 1 water			
9		Common	max. 250VAC / 1A
10		NC – normally closed	
11		NO – normally open	

Output 2 alarm			
12		Common	max. 250VAC / 1A
13		NC – normally closed	
14		NO – normally open	

All relays can be allocated according to your specifications. We recommend however, the following:

Recommended allocation for water softening:

Relay	Recommended Function
Relay 1	Limit (Alarm when limit is exceeded)
Relay 2	Unit fault / Breakdown

6.3 Connecting the current interface and digital inputs

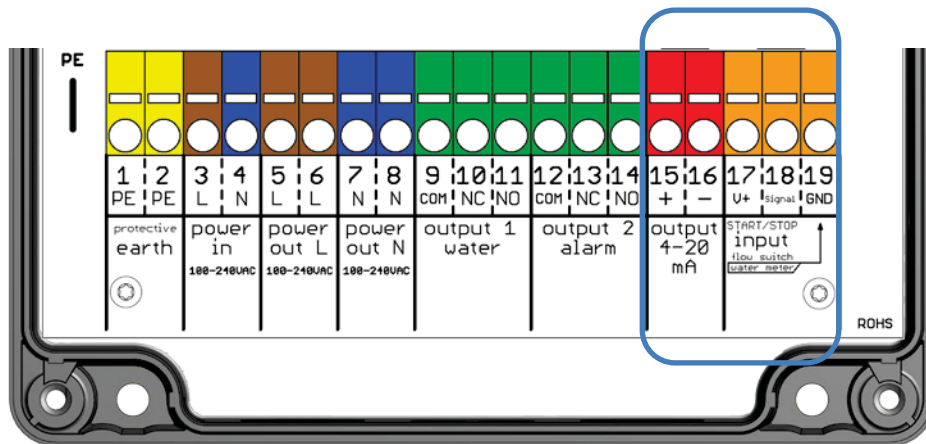

Terminal	Description	Function	Connection
----------	-------------	----------	------------

current interface

15	+ output 0-20mA or 4-20 mA	Current output	Output + current interface 0-20mA or 4-20mA
16	- output 0-20mA or 4-20 mA	Current output	Output - current interface 0-20mA or 4-20mA

START/STOP input

17	V+ START/STOP input	Voltage connector connect to Signal Start/Stop by switch.	Aux. voltage to connect potential free outputs
18	Signal START/STOP input	Input from auxiliary	Input signal
19	GND START/STOP input	Ground connector of input for three pole auxiliary	

All inputs can be allocated as you wish. We recommend however, the following:

Recommended input configuration:

Input	Function	
Input	Deactivated; Flow switch; Analysis request	

7 Components

7.1 Location of Components

The analysis unit consists of the following components: On the left hand, there is the control box with a graphic display and operating field. On the bottom of the control box, there are 4 cable entry fittings, to the right, the dosing-pump and under that, the measuring chamber.

The dosing-pump is simply clipped on and can easily be removed without any tools. The measuring chamber hangs on 2 studs at the side of the control box and can also be removed without any tools by simply pulling the 2 securing pins. Similarly, the reagent dosing plug, the input and output plugs are mounted on the measuring chamber and can easily be removed.



Position	Description
A	Control box
B	Graphic display
C	Operating field
D	Electric connection
E	ON / OFF switch
F	Dosing-pump
G	Dosing plug
H	Optical Measuring section / Transmitter
I	Measuring chamber(The securing pins can only be pulled and <u>not</u> be removed)
K	Magnetic stirrer
L	Water outlet plug
M	LED plug
N	Water inlet plug
O	Solenoid valve (behind the bottle)
P	Wall mounting plate
Q	Reagent bottle 500 ml
R	Water inlet(6mm pipe)
S	Water outlet(6mm pipe)

The measuring chamber is always at atmospheric pressure and full of water in order to avoid the development of algae. In the middle of the chamber, you find the white high powered LED transmitter. The sensor is located inside the control box. A magnetic stirrer is located underneath the measuring chamber. The magnetic stirring unit is securely fixed to the chamber.

At the bottom's right side of the mounting plate you will find the water inlet (left) and outlet (right) connectors both of which are secured to the mounting plate. The magnetic input valve is located behind the reagent bottle.

Magnetic valve in the water inlet line



7.2 Display and keyboard

The analysis unit has a graphic display that displays both the test results and the operating menu. The unit is set up by means of the 8 keys in the operating field. The background colour of the display changes according to the current function of the display:

Back-ground colour	Function
White	Unit working properly
Red	Limit exceeded or unit fault

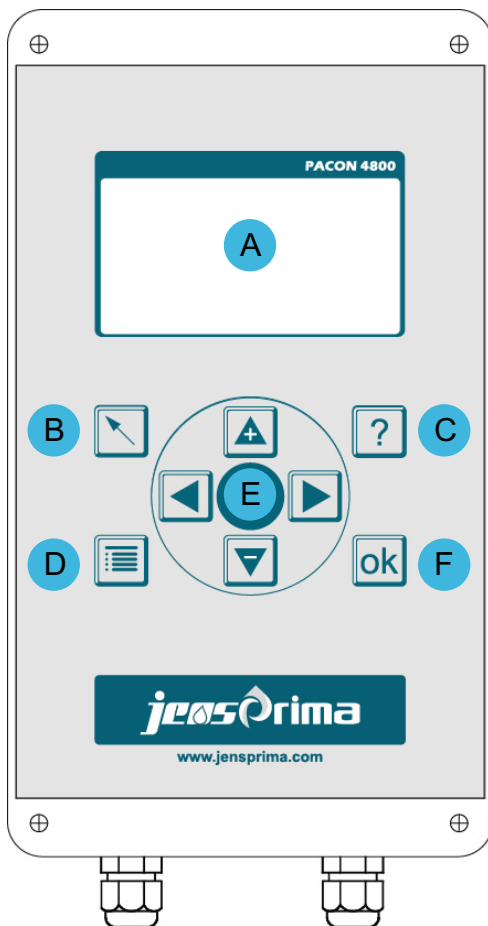

4 keys for navigation and entry of values are located in center (<> + -)

Position	Description
A	Display
B	Back / Reject last entry / Cancel current analysis
C	Renew reagent
D	Enter menu / Switch between menu and display of test results
E	Navigation
F	OK / Confirm

The display can be switched between “menu” and “measurement” by means of the menu key.

Display (Menu)

The menu window offers the following choices:

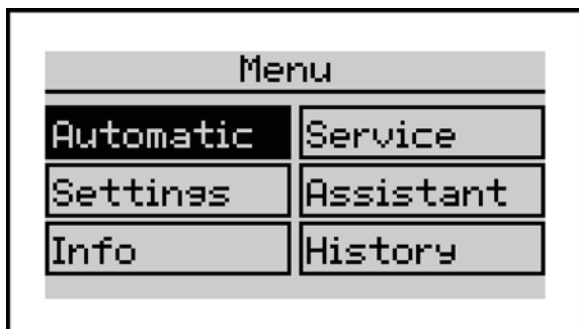

Automatic	Starts the automatic analysis operation
Service	Here you find all service functions like manual flushing, reagent pump, resetting counters and diagnosis
Parameter	Under this menu point various unit settings can be made
Assistant	Starts the configuration assistant and guides through all configuration options
Info	Informs about status of the software, date of manufacture and the serial number of the unit
History	Shows the last 100 measurements as a graph

Display (measurement)

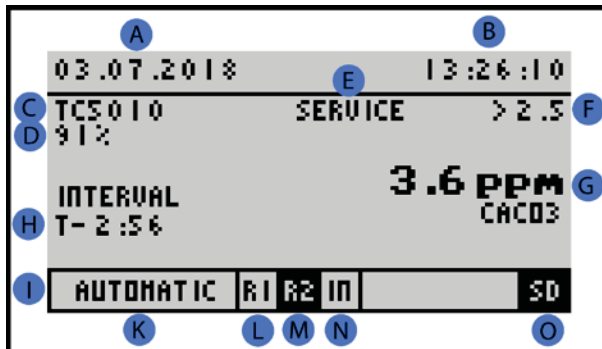

Position	Description
A	Date
B	Time
C	Reagent used
D	Reagent level
E	Device status (maintenance recommended)
F	Limit
G	Result of the previous analysis
H	Analysis step
I	Status bar
K	Automatic active
L	Relays 1 not active (active field black marked)
M	Relays 2 active (active field black marked)
N	Digital input 1 not active (active field black marked)
O	SD card present

Display (Reading progress)

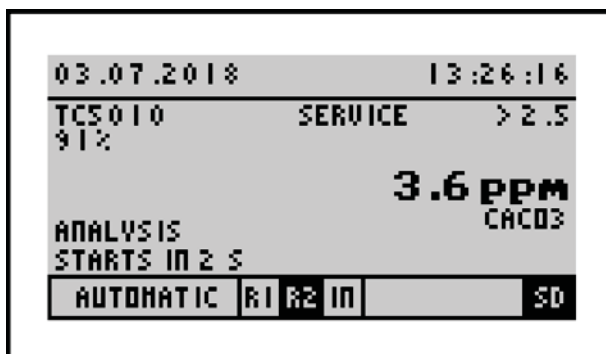

Simple start of analysis

By pressing and holding the [ok] button for more than 3 seconds, an analysis can be started. This function is available in manual and automatic mode.

Display (history)

With the help of the 'left' < and 'right' > keys you can call up the results history with date and time (max. 100 analyses). All results are stored on the SD-card and can be called up and read. The last 100 values are also stored in the analyser. The limit settings are shown as points on the graph.

You can call up the record by selecting **Menu >History**. By pressing the key [ok] or [back] you can return to the measuring value.

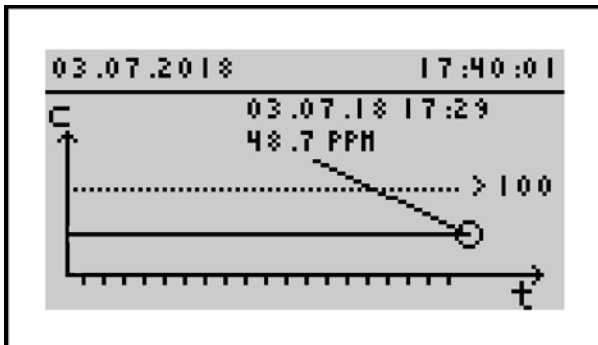

Display (Info)

The info screen shows you the version dates of hardware and software. Additionally, you will find the counters and maintenance information about the dosing pumps.

The screenshot shows a list of system information for 'JENSPRIMA'. The data is as follows:

JENSPRIMA	
HARDWARE VERSION	20.11.2017
SOFTWARE VERSION	19.04.2018
ANALYSIS COUNTER	0
MAINTANCE COUNTER	30000
MAINTANCE DATE	03.07.2020
GOOD MEASURE	0
BAD MEASURE COUNTER	0

Display (Select)

You can use the <> keys to change your choice. Confirm with [ok]. If you do not want to make any change, leave by pressing the [back] key.

In the figure below, the active choice is YES.

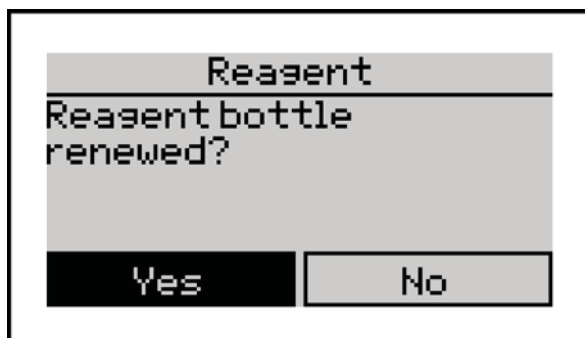

Display (Selection lists)

You can navigate the selection list by means of the 'up' + and 'down' – keys. Confirm with the [ok] key. Leave the list with the [back] key. If there are more than 3 choices in the list, you can use the scroll facility on the right of the display.

In the figure below, the active choice is reagent TH5001. It is shown by the black background with white font. The filled black circle shows the currently programmed option of this parameter.

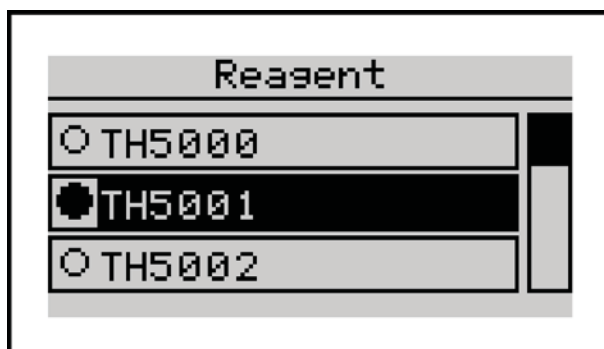

Display (Entering a value)

Numbers can be inserted via the virtual keyboard on the display. The cursor is moved by the <> + - keys. The entry mask shows the inserted numbers.

When the cursor is not moved and the [ok] key is pressed, the highlighted number will be entered.

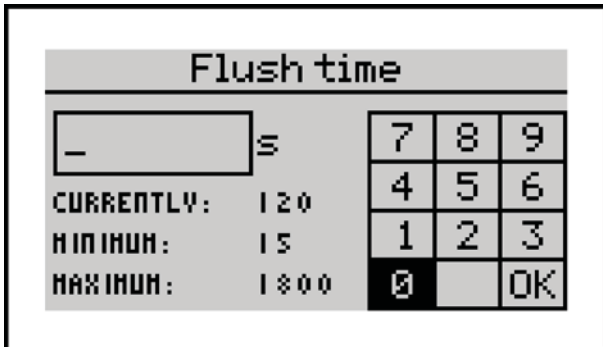

As an example: flush -time = 60 seconds.

Possible time durations are from 15 to 1800 seconds.

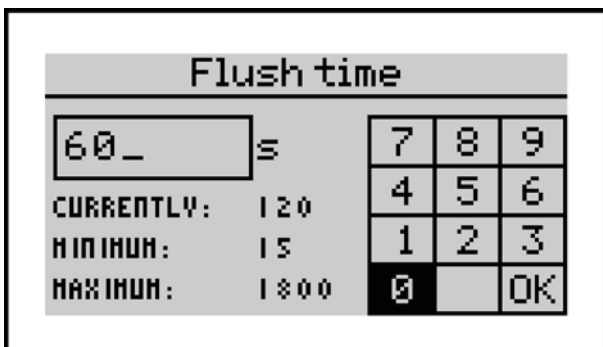

8 Connecting Additional Components

To facilitate the connection of additional components, the unit is equipped with 1 input, 2 relays and an analogue current interface. The input can be connected either via a potential free switch or via an electronic switch (open collector). A 24Vdc supply is available for the latter.

Do not connect any components with a voltage output to the inputs. Where necessary, a potential separation must be achieved.

If the input is not used, it should be programmed to “Disabled” in order to avoid malfunctions.

Menu > Settings > Input > Disabled

The outputs of the relays are potential free. To switch external units, the internal “mains out” can be used. Alternatively, an external power supply can be employed. Connection to external controllers is usually achieved via the potential free contacts of the relays.

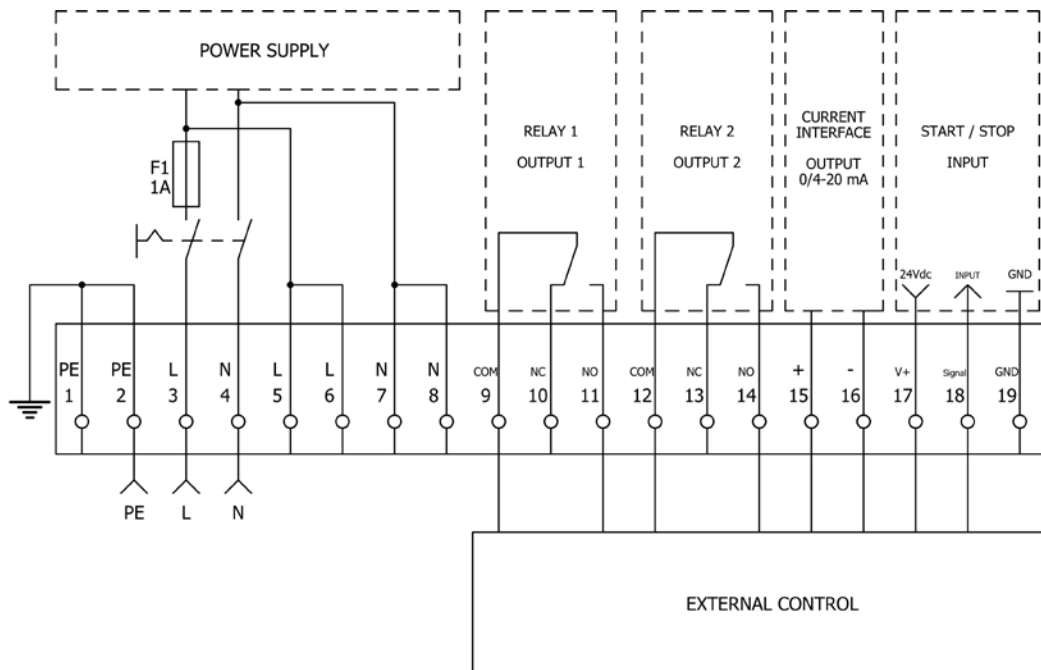

Overview of the terminal connections

8.1 Connecting a flow switch

An ion-exchanger is normally monitored at intervals of 10 minutes to ensure that a sudden hard water break through **doesn't reach the user**. Often though, there are longer pauses in operation or a storage tank has to be filled at irregular intervals. The flow switch is conceived for such eventualities.

A so-called paddle can be used as a flow switch. The potential free contact of a timer may be used, too – see example 1 below. Example 2 shows the connection of an electronic flow switch. Example 3 shows the converting of a 230V signal to a potential free signal. This example is useful in an osmosis plant where a water-softening unit only needs to be monitored when the pump of the plant is switched on.

Menu > Settings > Input > Flow switch

NB. This function should not be mixed up with the analysis start by external controller function.

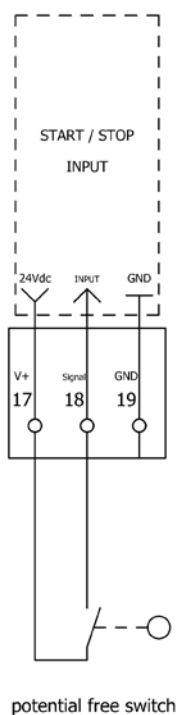

Example 1

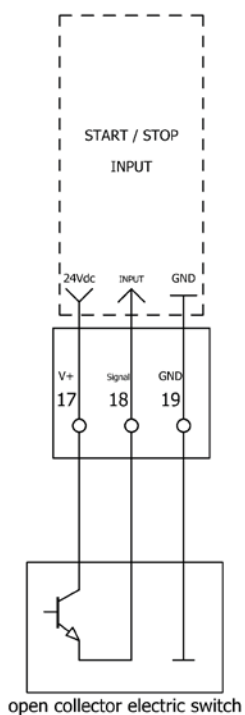

Example 2

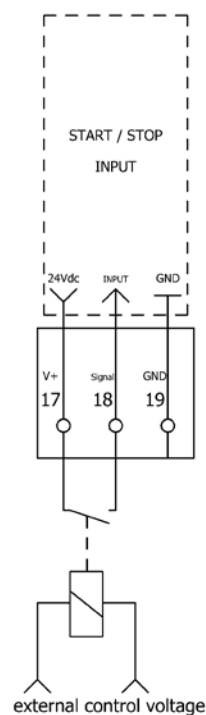

Example 3

8.2 Connecting a switch “Analysis START”

Additionally, it is possible to start an analysis via an external switch. This could be a potential free switch (example 1) or the relay output of an SPS controller (example 9).

Menu > Settings > Input > Start Analysis

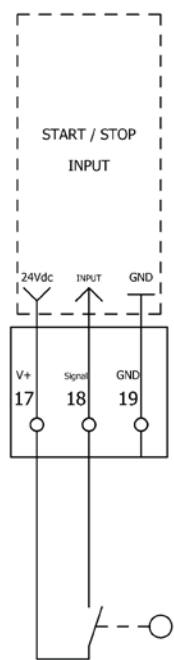

potential free switch

Example 1

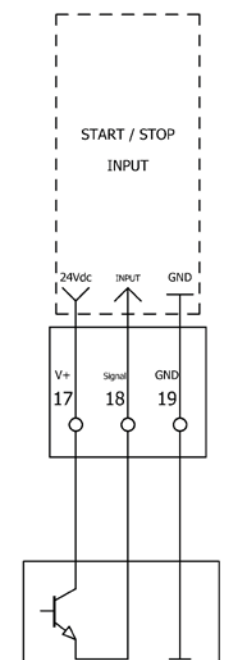

open collector electric switch

Example 2

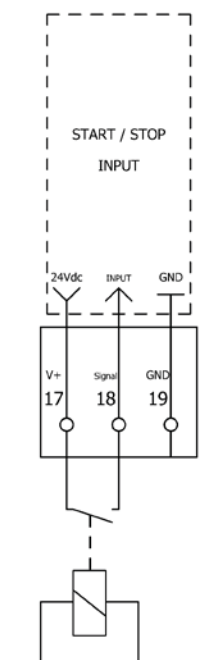

external control voltage

Example 3

8.3 Connecting buzzer / indicator light

A buzzer can be connected to signal the exceeding of limit, low reagent level or fault condition. Power for the buzzer can be acquired from the internal power supply.

Menu > Settings > Outputs> Relay 1 > Permanent or Impulse.

According to the required function.

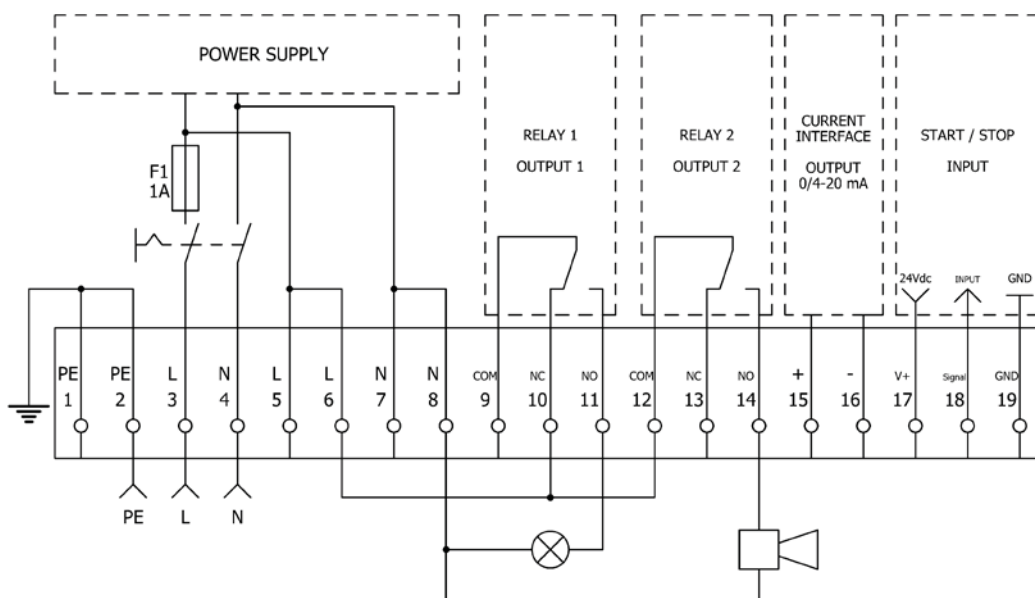

8.4 Connecting a Control Unit for a Regeneration Unit

Water treatment plants are generally regenerated according to the amount of water that flows through them. To ensure that no hard water gets through to the users, regeneration is carried out before the softening medium is exhausted. If the regeneration is activated via an analysis unit, softening medium and water will be saved. If the hardness of the water supply varies widely, a qualitative regeneration activation via an analysis unit is unavoidable.

The impulse delivery for activating the regeneration is achieved via **RELAY 1** (limit value). On account of longer standing time or higher demands, it might come to a premature regeneration. In case of a limit being exceeded, it is recommended to repeat the analysis.

Menu > Settings > Outputs> Relay 1 > Permanent or Impulse.

Menu > Settings > Analysis> Limit

According to the required function.

8.5 Connecting an Analogue measuring device

The actual measurement result is available as an analogue value. A recorder or other external device can be connected to evaluate and implement the results. You can choose between a current output of 0 – 20mA and 4 – 20mA. Additionally, you must define which degree of hardness relates to 20mA.

Menu > Settings > Outputs> Current loop type

Menu > Settings > Outputs> Current loop calibr.

select measurement range and unit of measurement

9 Configuration

9.1 Works Settings

The unit has the following works settings:

Menu>Settings>General>Factory setting.

		Parameter	Working setting
Settings	General	• Language	English
		• Data/Time	-
		• Import settings	-
		• Export settings	-
		• Factory setting	-
	Analysis	• Unit	(ppm CaCO ₃)
		• Reagent	Total hardness TH5001
		• Limit	5 ppm
		• Flush time	120 s
		• Auto. interval time	Yes / 10 min
		• Analysis stop	Off
		• Control measure	Off
	Input	• Calibrating factor	100%
		• Disabled	deactivated
		• Start Analysis	activated
	Outputs	• Flow switch	deactivated
		• Currentloop type	4..20 mA value
		• Currentloopcalibr.	5 ppm = 20 mA
		• Relay 1	Permanent
		• Relay 2	-

9.2 Configuration Assistant

The configuration assistant serves to simplify the initial commissioning. Via the menu, the unit guides you step by step through all necessary settings. At the same time, the complete functionality of the unit is checked.



All settings of the menu parameters can be changed again later.

To start the assistant, select the selection wizard in the menu and confirm with [ok].

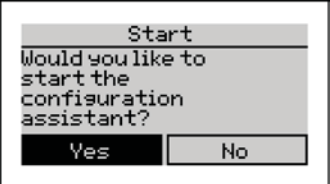
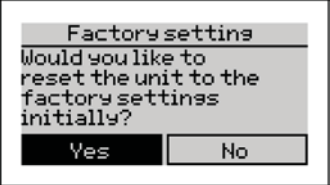
The following steps will be carried out:

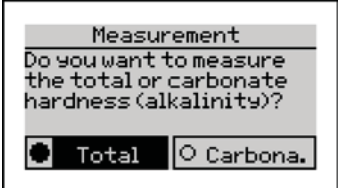
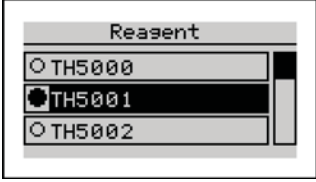
<p>Language Selection</p> 	<p>Please choose your language. / Bitte wählen Sie Ihre Sprache. [ok]</p> <p>You have the choice between:</p> <ul style="list-style-type: none"> • Deutsch • English • Francais • Italiano • Espaniol <p>Select and confirm with [ok]</p>
<p>Start</p> 	<p>Would you like to start the configuration assistant?</p> <ul style="list-style-type: none"> • Yes • No <p>Select and confirm with [ok]</p> <p>Yes: Starts the configuration assistant</p> <p>No: Returns to main menu</p>
<p>Factory setting</p> 	<p>Would you like to reset the unit to the factory settings?</p> <ul style="list-style-type: none"> • Yes • No <p>Select and confirm with [ok]</p> <p>Yes: Resets the unit to recommended settings</p> <p>No: The unit keeps your settings</p>

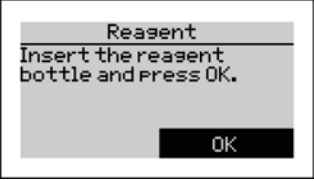
<p>Date</p> 	<p>Would you like to change time and date?</p> <p>• Yes • No</p> <p>Select and confirm with [ok]</p> <p>Yes:</p> <p>No:</p>
<p>Measurement</p> 	<p>Do you want to measure total or carbonate hardness?</p> <p>You have the choice between:</p> <p>Total hardness or carbonate hardness</p> <p>• Total • Carbonat (alkalinity)</p> <p>Select and confirm with [ok]</p>
<p>Reagent</p> 	<p>Please select your reagent [ok]</p> <p>According to measurement parameters, a choice of possible reagents is now shown:</p> <p>Total hardness: TH5000 to TH5100</p> <p>Carbonate hardness: TC5010 to TC5030</p> <p>Select and confirm with [ok]</p>

<p>Reagent</p>  	<p>Insert the reagent bottle and press [ok]</p> <p>The reagent pump starts the conveying of reagent. The conveying can be stopped with [ok]. After approx. 30 seconds, thereagent will have reached the measuring chamber.</p>
---	--

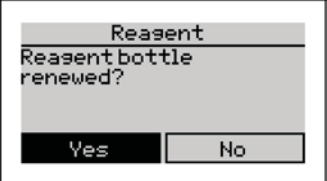
<p>Reagent</p> 	<p>Reagent bottle renewed?</p> <p><input type="radio"/> Yes <input type="radio"/> No</p> <p>Select and confirm with [ok]</p> <p>Yes:</p> <p>No:</p>
---	--

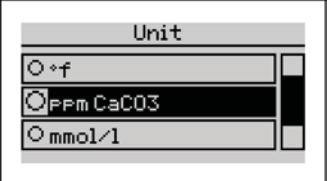
<p>Unit</p> 	<p>Please choose the unit in which your results should be displayed.[ok]</p> <p>You have the choice between:</p> <ul style="list-style-type: none">• °dH (German degrees of hardness)• °f (French degrees of hardness)• ppmCaCO₃• mmol/l• °e (English degrees of hardness) <p>Select and confirm with [ok]</p>
---	---

Flush

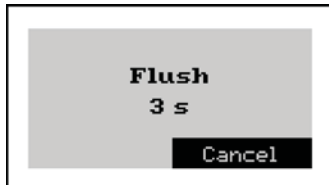
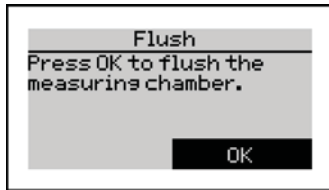

Press [ok] to flush the measuring chamber.

The magnetic valve opens, the measuring chamber is flushed. A seconds counter is launched.

The flushing time must be set according to the length of the inlet pipe and the water pressure. It must be long enough to allow a complete change of sample water in the chamber.

confirm with [ok]

Flush time

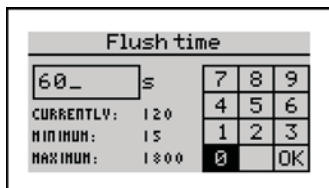

Insert your desired flushing time in the following mask.

confirm with [ok]

Insert the required flushing time. [ok]

Select with navigation keys and confirm. [ok]

Limit

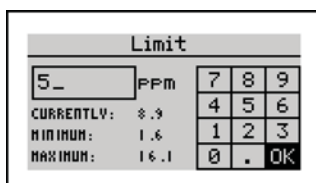

Specify the limit. Relay 1 is activated if the limit is exceeded.

confirm with [ok]

With this choice, you set the unit's logic to limit monitoring.

Insert the required limit.

Select with navigation keys and confirm. [ok]

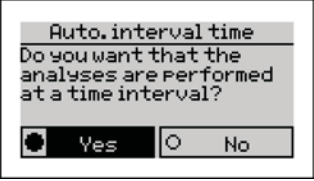
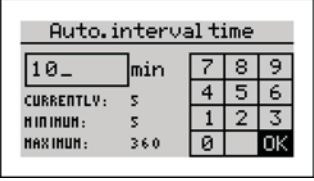
<p>Auto. interval time</p>  	<p>Do you want that the analyses are performed at a time interval?</p> <ul style="list-style-type: none"> • Yes • No <p>Select and confirm with [ok]</p> <p>If [Yes]</p> <p>Insert the required automatic interval time.</p> <p>Select with navigation keys and confirm. [ok]</p>
---	---

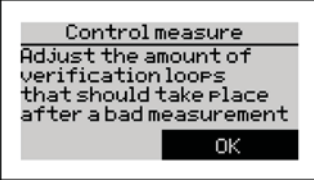
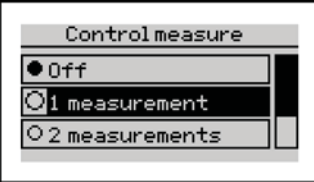
<p>Control measure</p>  	<p>Adjust the amount of verification loops that should take place after a bad measurement.[ok]</p> <p>You have the choice between:</p> <ul style="list-style-type: none"> • Off • 1 measurement • 2 measurements • 3 measurements <p>Select with navigation keys and confirm. [ok]</p>
--	--

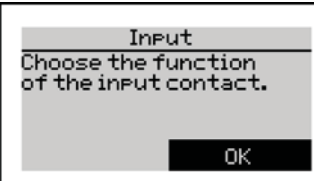
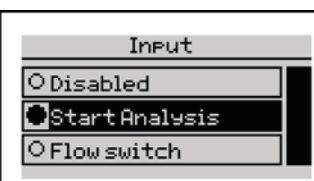
<p>Input</p>  	<p>Choose the function of input contact[ok]</p> <p>You have the choice between:</p> <ul style="list-style-type: none"> • Disabled • Start analysis • Flow switch <p>Select with navigation keys and confirm. [ok]</p> <p>If flow switch is selected:</p> <p>Is the type of your flow meter NC or NO?</p> <p>You have the choice between:</p> <ul style="list-style-type: none"> • NC (normally close) • NO (normally open) <p>Select with navigation keys and confirm. [ok]</p>
---	--

Relay 1

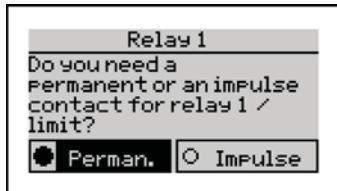
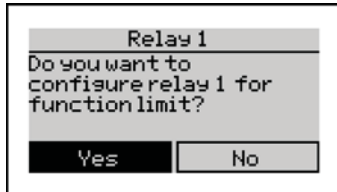

Do you want to configure relay 1 for function limit?

- Yes
- No

Select and confirm with [ok]

If [Yes]

Do you need a permanent or an impulse contact for relay 1 / limit 1?

- Permanent
- Impulse

Select and confirm with [ok]

Relay 2

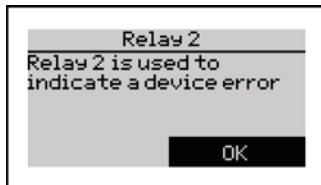

Relay 2 is used to indicate a device error.

Current loop type

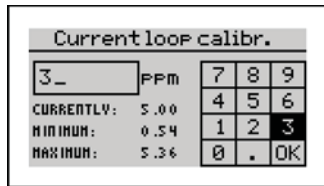
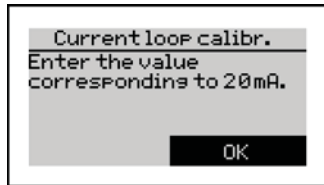
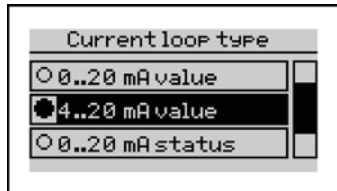
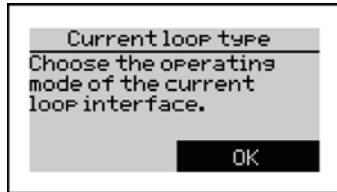

Choose the operating mode of the current loop interface.[ok]

You have the choice between:

- Off
- 0 .. 20 mA value
- 4 .. 20 mA value
- 0 .. 20 mA status
- 4 .. 20 mA status

Select with navigation keys and confirm. [ok]

If value is selected:

Select the corresponding measuring value of 20 mA[ok]

Insert the required value.

Select with navigation keys and confirm. [ok]

Assistant

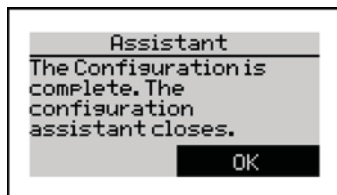

The configuration is complete. The assistant closes.[ok]

Now, the configuration of the unit is completed.

10 Operation

Manual and Automatic operation

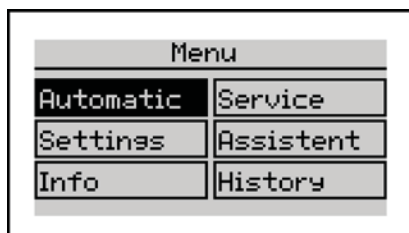

Menu	
Automatic	Service
Settings	Assistent
Info	History

In the automatic mode, **Menu >Automatic> Automatic on**, the analysis unit can be started by time, amount or via external switch. In the manual mode, **Menu > Automatic > Automatic off**, functions like analysis start, inject reagent or flush can be controlled manually. A diagnosis function by which individual components can be tested is also included in the manual mode.

Main menu

Via the main menu, you can set up the unit set **Menu >Settings**, start the configuration assistant **Menu > Assistant**, read back system information **Menu > Info** and carry out the necessary functions for maintenance and installation **Menu >Service**.

The operating of the analysis unit is virtually self-explanatory and all functions are well arranged in an arboreal structure.

10.1 Menu structure

The menu structure is explained in the following LIST in order to give you an overview of the various functions that the analysis unit offers.

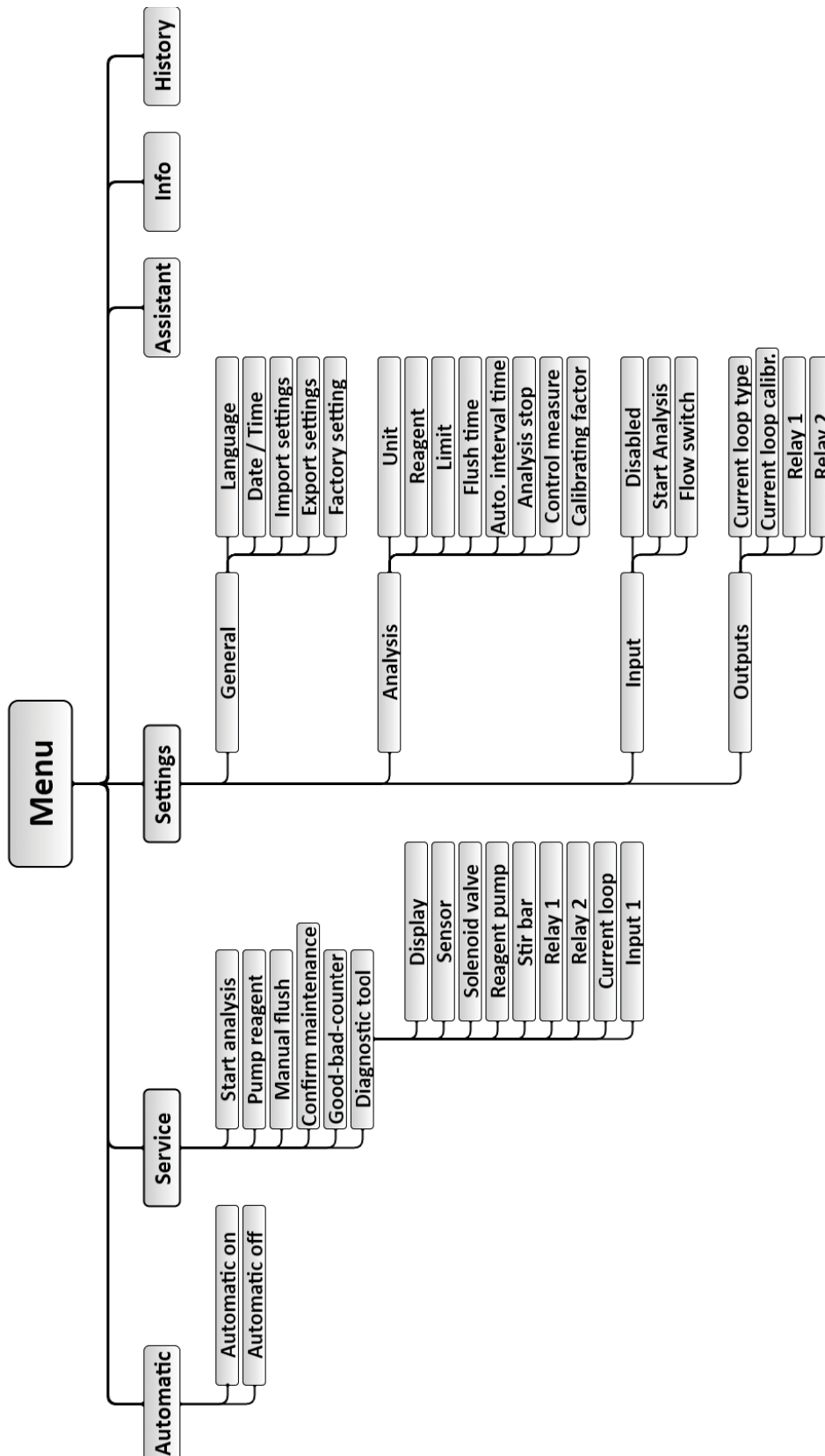

10.2 Action in case of power loss

Various settings can be saved on to the SD-card or in the internal memory. In case of a power loss, the settings will be available at the next power-up. If the unit had been running in automatic mode, it will automatically re-commence analysing after a short interval. The previous settings of amount and time intervals will still apply.

10.3 SD-Card

The analysis unit contains an SD-card. The following information is stored on this card: Test results, error reports, unit firmware.

The information is stored as .csv files. These files can be opened and further processed via an editor or table calculation programme (e.g. MS Excel, OO Calc). The system data remains on the SD-card (.bin).

The analysis unit is also fully functional without an SD-card. However, it will only store the last 100 test results in the internal memory.

If you use an SD-card other than the one supplied, it must be formatted as follows:

Memory capacity: recommended. 2.0 GB

Data system: FAT16

Size of the allocation data: 32 kByte

Bigger SD-cards can be formatted under e.g. Windows 7 > START > execute command und then by entry of format x: /FS:FAT /A32K. X stands for the letter of the disc-drive assigned to the SD-card.

The following files are saved on the SD card:

File name	Content
trend.csv	Contains the results in tabular form with date; time; result. The data is stored in the following format: YYYY.MM.DD [Tab] hh.mm [Tab] x.xxx [LF] The results (x.xxx) will be stored in the unit mmol/l. The relevant conversion tables can be found on page 57.
error.csv	Contains the results in tabular form with date; time; error. The data is stored in the following format: YYYY.MM.DD [Tab] hh.mm [Tab] Error code [LF]
history.bin	System data. These files contain the last 100 results which are loaded into the internal memory when the unit is switched on.
config.bin	System data. These files contain various settings of the analysis unit. If the analysis unit fails and has to be replaced, use menu function Parameter > General > Settings to import the unit settings and test result history.
TA27xxx.bin	<p>These files are not to be found on the SD-card. If software updates for your analysis unit are available, they can be acquired from our distributors or as a download from the home page.</p> <p>You can then copy these files on to the SD-card. Press and hold the [OK] key while switching the unit on. Following a security question, the new software can be successfully installed.</p> <p>We recommend that the files are removed from the SD-card after they have been installed in the unit.</p>

11 Maintenance and Service

In order to ensure a long and undisturbed functioning of the analysis unit, maintenance of the unit should be carried out at regular intervals. In most cases, tools are unnecessary. Before commencing maintenance work, ensure that the unit is switched off. During this period, no analyses will be carried out. Always wear protective glasses and gloves while carrying out maintenance to avoid contact with reagent, cleaning fluid or water.

Please observe the following maintenance intervals

Every 6 months	Clean the measuring chamber (by higher environmental or water temperatures or high levels of biocides, it may be necessary to reduce the interval)
Every 30.000 analyses or after 24months	Assemble maintenance set and reset maintenance counter

11.1 Cleaning of the measuring chamber

Cleaning of the measuring chamber requires about 20 minutes. This is done as follows:

- Remove the dosing-pump-cassette from its mounting by squeezing the clips above and below, then pulling outwards.
- Remove the connections to the dosing-plug and reagent-bottle.
- Pull the securing pins outwards until all the plugs are free. Do not try to remove the pins completely.
- Remove the chamber from the holding pins on the control box.
- Clean the chamber using the cleaning kit PACON Clean according to the instructions.

When re-assembling, please keep the following order:

- Push the clean chamber on to the two holding pins and push in the securing pins to secure.
- Re-insert all plugs and secure with securing pins. Ensure that the plugs are firmly pushed in to their holes before attempting to push in the securing pins. **Do not force!** This may lead to damage of the plugs or pins. All pipes must be free and not twisted.
- Switch the unit on again, flush the measuring chamber, then pump reagent into the chamber. The unit is now ready for use.

11.2 Changing the dosing-pump-cassette

It is necessary to change the dosing-pump-cassette at regular intervals. It is included in the “maintenance set for PACON 4800” (Art.-No: 33-090034). The exchange takes about 10 minutes.

The exchange is executed as follows:

- Switch the unit off.
- Remove the connections to the dosing-plug and reagent-bottle.
- Remove the pump-cassette from its mounting by squeezing the clips above and below, then pulling outwards.
- Remove the dosing plug at the top of the chamber by pulling the 2 securing pins and gently pulling the plug upwards.
- Discard cassette and tubes.

When re-assembling, please keep the following order:

- Connect the cassette to the reagent bottle. Turn the bottle until all bends are removed and the pipe hangs free.
- Connect the cassette to the dosing-plug. First, ensure that the pipe is not twisted, then re-insert the plug. Ensure that the plug is firmly pushed into its hole before attempting to push in the securing pins. **Do not force!** If you have difficulty inserting the plug without force, put a bit of Vaseline on the o-ring.
- Clip the cassette securely on to the pump.
- Switch the unit back on, flush and pump reagent into the chamber. The unit is now ready for use
Menu > Service > Pump reagent
Menu > Service > Manual Flush
Menu > Service > Confirm maintenance

11.3 Changing the reagent bottle

Ensure that the new reagent is within its best before date. Only use fresh reagent.

The exchange is executed as follows:

- Switch the unit off.
- Unscrew the cap and remove the bottle adapter and the suction lance. Insert these in the new bottle and secure cap. Clean up any spilled fluid.
- Switch the unit back on and press reagent button. Follow the guidance on the display. By confirming the reagent bottle change after the injection of reagent, the reagent level will be reset to 100%. Only use 500 ml bottles.

11.4 Calibrating the unit

The unit is calibrated at the factory at a room temperature of 20°C. If the unit is to be used in exceptionally hot or cold environments, please re-calibrate when commissioning.

You can calibrate the unit as follows:

- Carry out an analysis using the unit. The hardness of the sample has to be within the measuring range of the reagent used. A calibration with a value like '<0,1 °e' is not possible.
- At the same time, carry out an analysis in the laboratory (lab.)
- Calculate the correction factor for the unit with the following formula:

$$\text{Correction factor} = \frac{\text{Value}(lab.)}{\text{Test result}} \times 100\%$$

- Insert the correction factor into the unit via **Menu >Settings> Analysis >Calibrating factor**

11.5 Changing the battery

If the unit does not show the time when it is switched off, it is necessary to change the back-up battery as follows:

- Switch off and disconnect the power from the unit.
- Open the control box by removing the 4 screws. The battery holder is located on the circuit board under the lid.
- Replace the battery with the type CR2032. Check that the plus side of the battery is connected to the plus side of the battery holder.
- Ensure that the ribbon cable between the 2 circuit boards is not loose. Close the control box again.
- Dispose of the battery in a responsible way.

11.6 Software Update

The analysis unit offers the possibility to update the software. In the framework of product improvement, you can receive updates from our agents or from our home-page. If necessary, the agent will send you the data with the file-name TA27xxx.bin.

To install an update:

- Switch off the unit.
- Open the control box by removing the 4 screws. The battery holder is located on the circuit board under the lid. Remove the SD-card from its slot under the lid.
- Copy the .bin file on to the SD-card using a computer and then return the SD-card into the unit.
- Ensure that the ribbon cable between the 2 circuit boards is not loose. Close the control box again. Reconnect power.
- Press [ok] while switching on the unit. The unit will actuate the software and recommence normal operation.
- To avoid unnecessary reinstallation of the update, switch the unit off again. Remove the SD-card and delete the .bin files from it.
- Re-insert the SD-card in its slot under the lid.
- Switch on and check the unit configuration.

12 Error Analysis

12.1 Fault finding

The analysis does not start

- Check if the flow meter is correctly configured and connected.
- Check if the interval time is set.
- Check if a water meter is connected and correctly configured.
- Check, if relevant, connections from an external controller.

Error during the blank test

- Check if there is water in the chamber and that the supply and waste pipes are not swapped.
- Check the chamber for dirt, gas bubbles or impurity.
- Check the water pressure (recommended 1-2 bar).
- Check if the waste pipe is free and that there is no impurity in the solenoid valve.
- If a pump is used to supply the sample water, ensure that it is properly connected.
- Check the function sensor and solenoid valve with the help of the diagnosis menu.

Error during titration

- Check if there is enough reagent available.
- Check the pipes between the reagent bottle and the dosing-pump for air bubbles. If necessary, pump reagent until the pipes are full of reagent.
- Check if the blue o-ring is still on the nozzle of the dosing-plug.
- Check if there is water in the chamber.
- Check if there is a magnetic stirrer (stir-fish) in the chamber.
- Check the reagent conveying, the sensor and the stir-fish with the diagnosis menu.

False test result

- Check if the reagent corresponds to that programmed.
- Check for air bubbles in the reagent delivery pipe.
- During the blank test, check if the sample water is not coloured by foreign substances, sediment or air bubbles.
- Check if there is water in the chamber and that the supply and waste pipes are not swapped.
- Check if there is a magnetic stirrer (stir-fish) in the chamber.
- Check if the blue o-ring is still on the nozzle of the dosing-plug and that it is positioned correctly.
- Check if the solenoid valve closes properly.
- Exchange the reagent pump-cassette.
- Re-calibrate the unit with a new correction factor.

12.2 Diagnosis function

If the analysis unit doesn't work properly, you have the possibility to check all the functions. Please take into consideration any controllers and peripherals that are connected. Observe all safety regulations.

Menu >Service> Diagnostic tool. You can check every part step by step:

Display

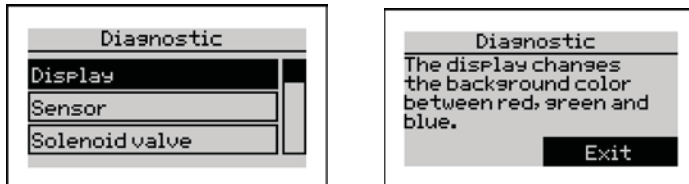

The display changes its colour between red, green and blue.

Sensor

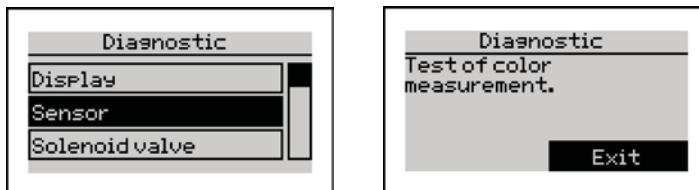

The LED in the chamber pulses on and off. If this doesn't happen, check the electrical connections to the LED-plug and in the unit. If everything is ok, the LED-plug must not be replaced. After the first light pulse from the LED it is possible to use a red, green or blue coloured foil to test the colour recognition. If you put the foil into the light beam, the display changes to the colour of the foil.

Solenoidvalve

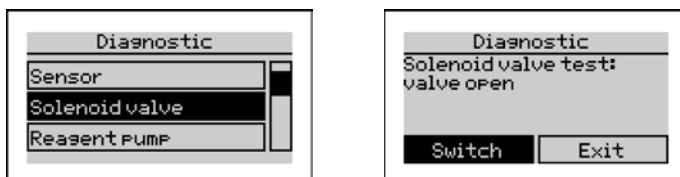

You can hear the solenoid valve in the water inlet open and close. If this is not the case, check the electrical connections to the valve and inside the unit. If all connections are okay, measure the voltage at the valve while the test is in progress. It should switch between 0V and 20V. If this is okay, an electrical error can be eliminated. Replace the solenoid valve.

Reagent pump

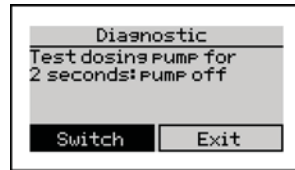
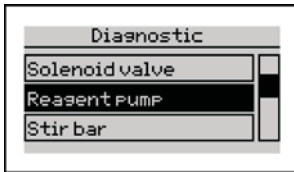

When the diagnosis starts, the dosing pump can be watched turning. It can also be heard. If this is not the case, check the 4 pole connector on the circuit board. If you can hear the motor but there is no movement, the pump-cassette is defect. If the connections are okay and the pump can neither be seen nor heard working, the pump is defect or there is a fault in the electronics.

Stirbar

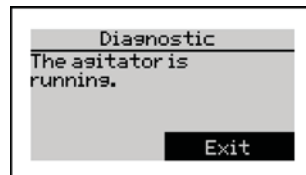
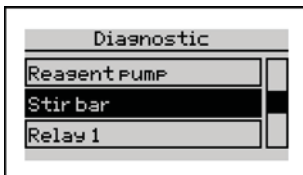

The magnetic stirbar in the measurement chamber should spin. If the stirrer doesn't spin, check the connection to the circuit board (red plug, Pos.K).

Remove the chamber and check if anything is obstructing the movement of the drive disk.

If the above is okay, change the motor assembly.

Relay 1 to 2

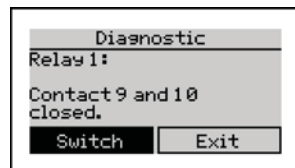
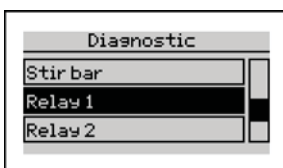

When this function is selected, you can test the relays manually.

Using a continuity meter or buzzer, measure between clamp 9 and 10 for relay 1 and test the connection. With function button switch the relays 1 switches to contact pair 9 and 11. Testing relays 2 as relays 1 with connectors 12, 13 and 14.

Currentloop

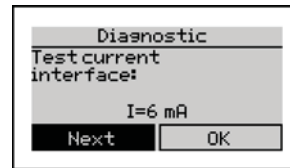
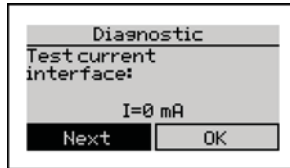
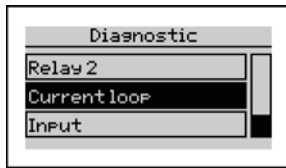

To test the current loop, a test meter set to mA is necessary. Connect the meter probes to the clamp 15 marked + 20mA and clamp 16 marked -20mA. At the beginning, the current interface supplies no current ($I = 0$ mA). Each time you click [Next], the current increases by 2 mA up to 20 mA. Compare the adjusted current with the measured values of the test meter. A maximum deviation of 0.5 mA is permissible depending on the quality of the connected measuring equipment and the ampere measuring range used. Please make sure that the meter is calibrated.

If the deviation is more than 0.5mA, the control circuit board must be changed.

Input

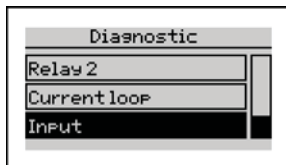

To test the Input, a jumper wire is necessary. Display shows "contact between terminals 17 and 18 opened". When the contacts are shorted with wire jumper, display shows "contact between terminals 17 and 18 closed". If that does not work, the control circuit board must be changed.

13 Spare parts

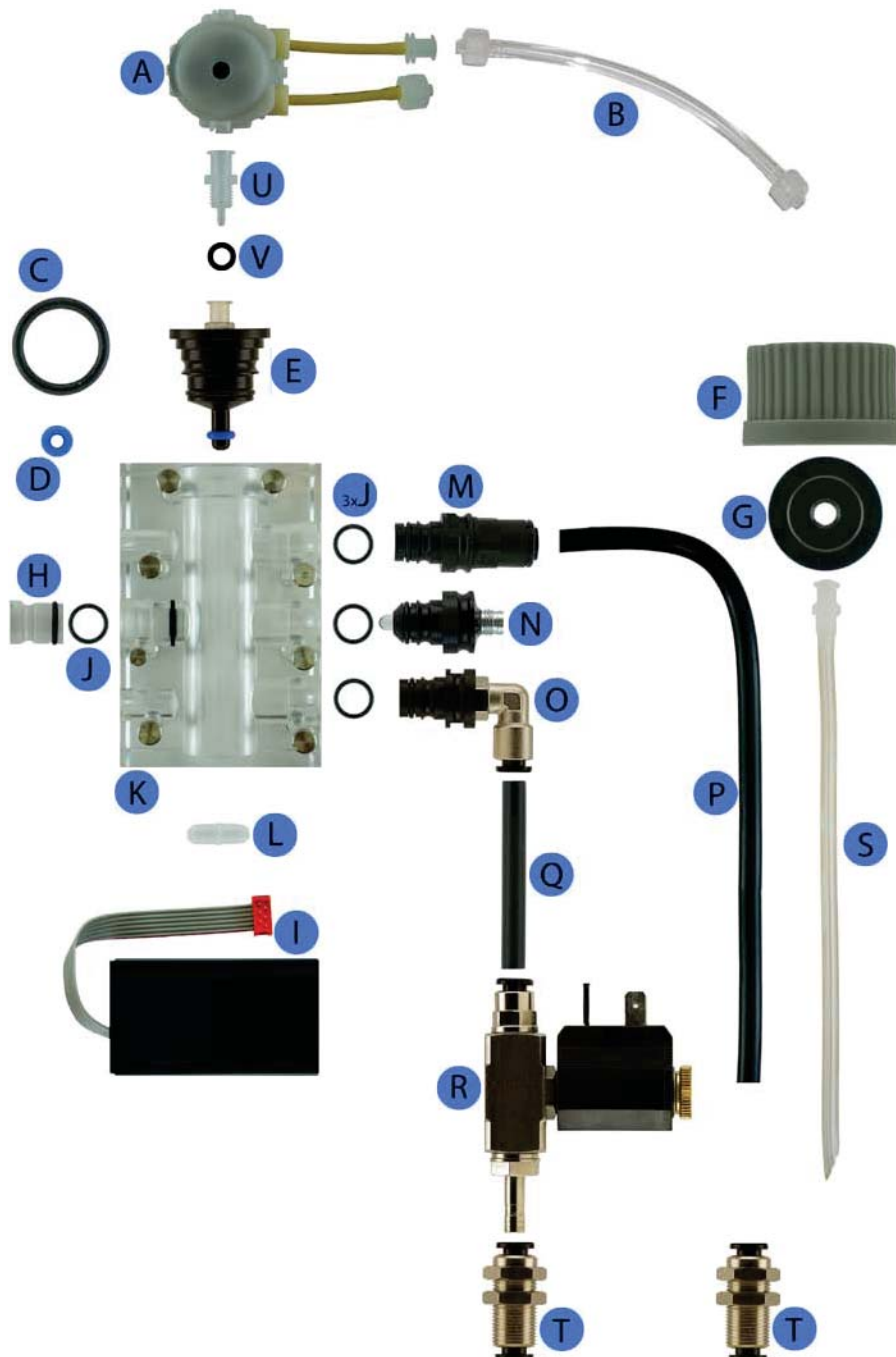

Pos.	Description	Articleno
A	Dosing-pump cassette	50-030 614
B	Bottle connector	50-090 008
C	O-Ring 16 x 2	50-090 217
D	O-Ring 3,2 x 2,5 (blue)	50-090 218
E	Dosing plug incl. Pos. C, D, U, V	50-090 716
F	Bottle cap	50-093 060
G	Bottle adapter	50-090 009
H	Light rod plug for measuring chamber incl. Pos. J	50-090 719
I	Actuator for magnetic stirrer	50-090 056
J	O-Ring 9 x 1,5	50-090 210
K	Measuring-chamber incl. Pos. H	50-090 731
L	Magnetic stirrer	50-090 002
M	Outlet plug 6mm incl. Pos. J	50-090 712
N	Actuator plug (LED) incl. Pos. J	50-090 713
O	Inlet plug 6mm incl. Pos. J	50-090 156
P	Outlet pipe 6mm	50-090 124
Q	Inlet pipe 6mm	50-090 112
R	Solenoid valve 24V	50-090 157
S	Suction lance	50-090 011
T	PACON 4500/4800/5000 connector 6 mm	50-090 116
V	O-Ring 5,28 x 1,78	50-090215
U	Luer connector	50-090 414

Spare parts that are not shown on the picture

Description	Artikelnummer
Measuring-chamber complete for PACON 4500/4800/5000 incl. all connections (H, E, M, N, O, L)	50-190 700
Display PCB	50-033 607
Main PCB	50-030641
Peristaltic pump with motor	50-030 625
Connector cable for solenoid valve	50-090079
Connector cable for LED	50-090074
Maintenance set for PACON for latest half-year maintenance incl. (A, B, C, D, S, 4 x J)	50-090 034

For more spare parts see chapter "Maintenance sets"

14 Measuring range of our reagents

14.1 Reagents for monitoring the total hardness

Article Reagent	Range			Order no. 500ml bottle
	°dH	ppm CaCO ₃	°f	
TH5000	0.012 ↔ 0.12	0.224 ↔ 2.13	0,036↔0,214	50-5000-01
TH5001	0.03 ↔ 0.3	0.543 ↔ 5.43	0,053↔0,53	50-5001-01
TH5003	0.09 ↔ 0.9	1.6 ↔ 16.0	0,16↔1,6	50-5003-01
TH5010	0.30 ↔ 3.0	5,34 ↔ 53,4	0,53↔5,34	50-5010-01
TH5030	0.9 ↔ 9.0	16.0 ↔ 160	1,6↔16,0	50-5030-01
TH5050	1.5 ↔ 15.0	26.7 ↔ 267	2,7↔26,7	50-5050-01
TH5100	3.0 ↔ 30.0	53.4 ↔ 534	5,4↔53,4	50-5100-01

14.2 Reagents for monitoring the carbonate hardness (alkalinity).

Article Reagent	Range			Order no. 500ml bottle
	°dH	ppm CaCO ₃	°f	
TC5010	0.3 ↔ 7.5	5.34 ↔ 134	0.5 ↔ 13.3	50-5510-01
TC5015	0.45 ↔ 11.5	8.0 ↔ 205	0.8 ↔ 20.5	50-5515-01
TC5020	0.6 ↔ 15.0	10.7 ↔ 267	1.1 ↔ 26.7	50-5520-01
TC5030	0.9 ↔ 22.5	16.0 ↔ 401	1.6 ↔ 40.0	50-5530-01

15 Calculation table for common units of water hardness

		°dH	°e	°fH	ppm	mval/l	mmol/l
German Hardness	1 °dH =	1	1.253	1.78	17.8	0.357	0.1783
English Hardness	1 °e =	0.798	1	1.43	14.3	0.285	0.142
French Hardness	1 °fH =	0.56	0.702	1	10	0.2	0.1
ppm CaCO₃ (USA)	1 ppm =	0.056	0.07	0.1	1	0.02	0.01
mval/l Earth alkali	1 mval/l =	2.8	3.51	5	50	1	0.5
mmol/l Earth alkali	1 mmol/l =	5.6	7.02	10	100	2	1

16 Instructions for disposal

- Do not dispose of the unit in household rubbish.
- The unit should be brought to a certified collection point for electrical devices.
- The battery must be disposed of separately.

The unit can also be returned to the dealer or manufacturer for proper disposal.



JENSPRIMA INSTRUMENTS LIMITED

www.jensprima.com

**WE ENDEAVOR TO KEEP OUR UNITS UP TO DATE AND THEREFORE WE
RESERVE THE RIGHT TO MAKE TECHNICAL CHANGES WITHOUT PRIOR
NOTICE.**