

# GAS FLOWMETER GD 300 (Ex) / GD 500 Ex

for measuring of all technical and medical gases from DN 15 to DN 400

Rev.-no.: GD 300-DS 312 E-V2.3 2021-10-26

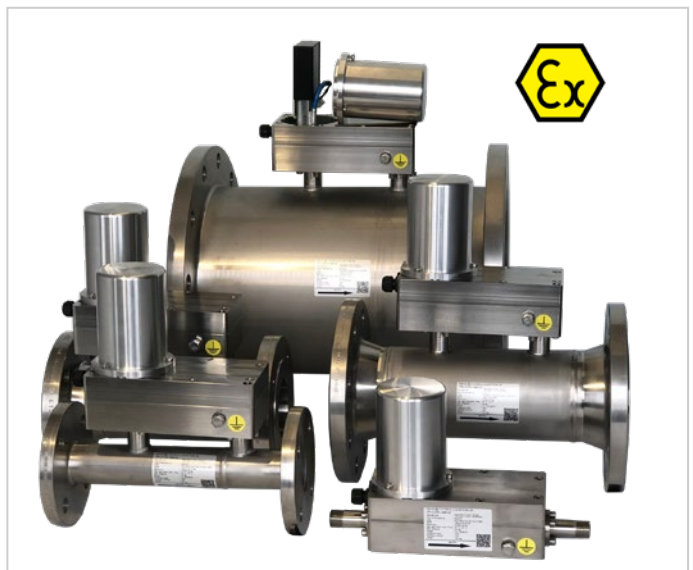

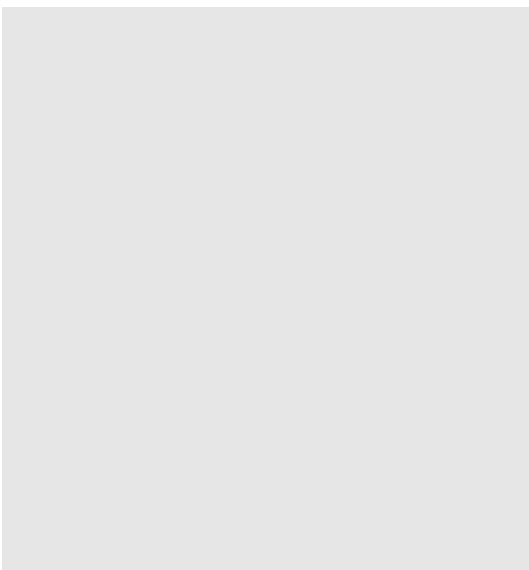
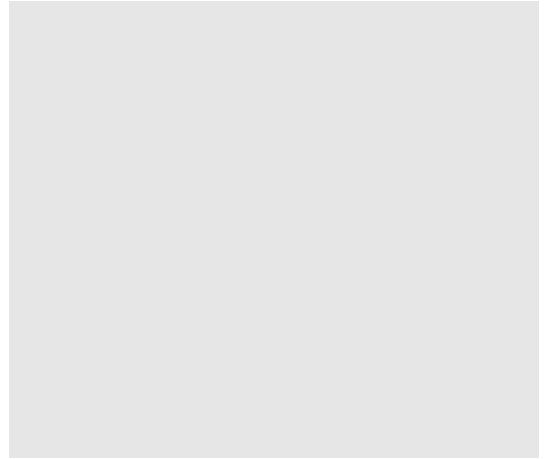
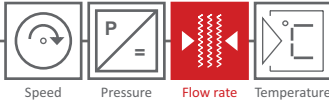

## Table of content

Overview	3
Application Range	4
Principle of Measurement	5
Technical Details	6
Flow / Pressure Loss	7
Accuracy of Measurement	7
Measuring Range	8
GD 300 (Ex) with intermediate flange, wafer / sandwich	8
GD 300 (Ex) with flange	8
GD 500 (Ex) with external pipe thread	9
Dimensions and Weight	9
GD 300 (Ex) with intermediate flange, wafer / sandwich	9
GD 300 (Ex) with flange	10
GD 500 (Ex) with external pipe thread	11
Project planning	12
Decision tree for compiling the measurement solution	12
Installation Instructions / Maintenance	13
Ordering Information	14
GD 300 (Ex) - DN 25 to DN 400 with intermediate flange, wafer / sandwich <b>NEW!</b>	14
GD 300 (Ex) - DN 50 to DN 80 with flange	15
GD 300 (Ex) - DN 100 to DN 400 with flange	16
GD 500 (Ex) with external pipe thread	17
HB 300 (Ex) - integrated calculator in the measuring head of the GD 300 (Ex) / GD 500 (Ex)	18
External Flow Computer GDR 1501	19

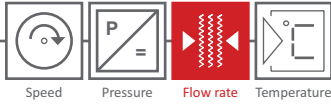

Speed Pressure **Flow rate** Temperature

## Overview



- Oscillating measuring method suitable for almost all types of gas (including mixed gases), no moving components
- Excellent results measuring variable gas mixtures, since density-independent measurement method
- Excellent results measuring moist gases with condensate
- Measuring housing, orifice and measuring labyrinth made of stainless steel, also available as heavy duty construction
- Resistant to dirt, e.g. oil, rust, sulphur
- Use with extremely corrosive and inert gases
- Mounting in falling direction into gas lines even for 100 % damp biogas due to integrated condensate discharge
- Intermediate flange version (wafer, uniform installation length 65 mm) for easy replacement of existing flow meters, simple and space-saving installation regardless of the installed flange type (ISO or ASME flange), shortened inlet section 2.5 x DN
- Optional integrated ball valve (blocking valve) in the GD 300 for removal/installation of the platinum sensor without emptying the system
- Integrated calculator HB 300 in the measuring head with mA- (normalization optional) or pulse output
- Short response time  $T_{90} \leq 50$  ms with a flow velocity  $\geq 0,25$  m/s
- High accuracy ( $\pm 1,5$  % of true value)
- High reproducibility (0,1 % of true value)
- Low pressure loss
- Each flowmeter with calibration report
- Recalibration not required
-  II 1 / 2 G Ex ia / e mb IIC T4 Ga / Gb (certificate no. EX5 13 07 14689 003)

**NEW!**

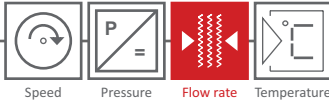

## Application Range

The product family GD 300/GD 500 is used in a variety of applications that require the measurement of technical and medical gases.

### Mine and digester gas (biogas, sewage gas)

One of the strengths of the fluidistor measuring principle is its insensitivity to particles and moisture in the gas. Particularly in the fields of biogas and sewage gas, excellent measurement results are achieved despite contamination and condensate formation as well as possible sulfur levels of several 100 ppm.

In sewage treatment plants, measurements on the digestion tower often lead to incorrect measurements because the gas is contaminated and has a high level of water vapor saturation. The fluidistor measuring method is insensitive to water vapor saturation and particle pollution of the gas. It does not influence the measured value due to the formation of condensate on the sensor.



The Fluidistor Gas Flowmeter has no mechanically moving parts (e.g. turbine wheel or impeller) that could influence the measured value due to deposits due to particle contamination. Deposits occur due to the contamination of the gas in both thermal measuring methods and measuring methods with mechanically moving parts. This can result in gradual measurement errors.

Heavy soiling, caused by e.g. foaming or high sulfur levels can be cleaned independently on the system using a steam jet. Depending on the installation situation of the device, this can in many cases even take place when installed.

The fluidistor measurement process is not affected by water vapor saturation, sulfur pollution or gas pollution and provides exact measurements.



### Medical gases

The devices in stainless steel are excellently suited for the measurement of oxygen, nitrous oxide, compressed air, nitrogen, carbon dioxide, argon and helium in medical applications. Especially the GD 500 with a resolution of 1 litre/min is ideal for the billing of small units (licensed beds) in hospitals and contributes to more transparency in billing.

### Technical gases

In addition to the gas flowmeter in stainless steel there is an economic solution made of aluminium for consumption measuring in industrial production. The devices are suitable for technical gases, e.g. compressed air, carbon dioxide, argon, nitrogen, oxygen and natural gas.

In the industrial sector the devices are designed for the gas flow measurement of technical gases, e.g. compressed air, carbon dioxide (fermentation and cooling), argon (steel production), nitrogen, oxygen and natural gas (burner control, intake screening of boilers). The Fluidistor also works with changing gas mixtures!

In respect to the very fast response of the GD 300/GD 500 ( $T_{90} \leq 50$  ms) the gas flowmeters are especially suited for monitoring and logging of product cycles based on pneumatic energy.

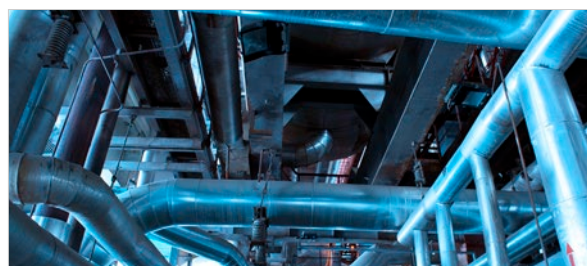

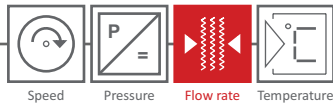

Speed Pressure Flow rate Temperature

## Principle of Measurement

The flow meter GD 300 (Ex) / GD 500 (Ex) operates according to the principle of a „Fluidistor oscillator“. The gas passes the Fluidistor measuring head either directly or via an orifice in the main pipe.

The gas is discharged through the orifice into the Fluidistor measuring chamber. Directly behind the inlet there is a triangular damming body, which, due to the unstable middle position, forces the gas either to flow past on the right or left. At the level of the damming body in the right and left wall of the Fluidistor measuring chamber are two openings which are connected to each other by a channel. If the gas flows to the left from the damming body, a negative pressure is created on the left side wall or at the opening of the connecting channel. This negative pressure is balanced through the right opening of the connecting channel. The pressure equalization of the negative pressure causes a change of flow direction from the left to the right side. The entire process is then repeated on the right side.

The period of time required for pressure equaliza-

tion corresponds to a special amount of gas (litre/ pulse), which has passed through the GD 300 (Ex) / GD 500 (Ex). The frequency of the pressure equalization is proportional to the flow velocity.

The changing flow through the connecting channel is detected by a platinum wire (diameter 15  $\mu$ ) in the connecting channel. A constant voltage is applied to the wire, which is permanently monitored. At the moment when the pressure equalization occurs in the connecting channel, the wire is not circulated around by gas for a short time and heats up due to the current flowing through the wire. This causes a temporary rise of the resistance in the platinum wire (like a Pt100 sensor) and the voltage drop ( $V=R \cdot I$ ) increases. This increase in voltage drop is recorded by the integrated calculator HB 300 (Ex) and the measured values can either be transmitted directly to a higher-level PLC system via a current output or the signals are sent to the volume corrector GDR 1501 via the native pulse output. In the NON-ATEX area, the volume corrector GDR 1501 can be connected directly to the platinum wire sensor.

Rev.-no.: GD 300-DS 312 E-V2.3 2021-10-26

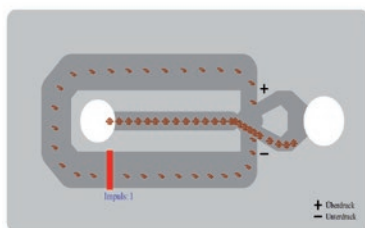

- outflow of the gas through the right outlet
- active pressure equalization in the connecting channel from right to left

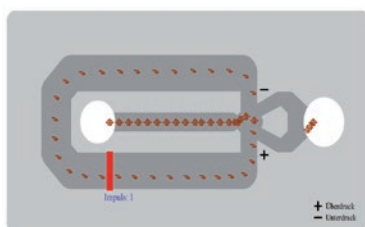

- pressure compensation in the connecting channel with an incipient change of direction from left to right

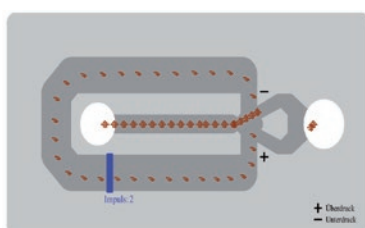

- short-term nonoperating of the gas flow in the connection channel
- heating of the platinum wire



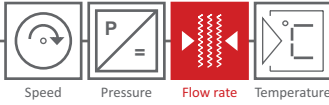

## Technical Details

	GD 300 (Ex) WITH INTERMEDIATE FLANGE WAFFER/SANDWICH	GD 300 (Ex) WITH FLANGE	GD 500 (Ex) WITH EXTERNAL PIPE THREAD
	 <b>NEW!</b>		
NOMINAL SIZE	DN 25 - DN 400	DN 50 - DN 400	DN 15 - DN 25
PROCESS CONNECTION	intermediate flange, wafer/sandwich installation length: 65 mm	flange acc. to DIN EN-1092-2 or DIN 2576 depending on availability flange acc. to ASME B 16.5 installation length: 300 - 500 mm details see diemnsions	external pipe thread R 1/2" G 1" installation length: 300 mm
PRESSURE RANGE	0,5 bar, 10 bar, 16 bar	0,5 bar, 10 bar, 16 bar, 40 bar (ISO flange) class 150, class 300 (ASME flange)	0,5 bar, 10 bar, 16 bar, 40 bar
TEMPERATURE MEDIUM	NON ATEX: -20 to +120°C ATEX: -20 to +80°C		
AMBIENT TEMPERATURE	NON ATEX: -20 to +120°C ATEX: -20 to +45 °C		
MEASURING HEAD, LABYRINTH	material stainless steel 1.4404, aluminium	material stainless steel 1.4571 (V4A), aluminium	
TUBE BODY	material stainless steel 1.4404	material stainless steel 1.4571 (V4A)	-
SENSOR	material platinum		
PROTECTION CLASS	IP 65		
OUTPUT (STANDARD)	native pulse output: pulse 24 V, DC, max. 200 Hz (pulse width 1 - 2 ms) status output for sensor break detection: 24 V, DC (		
OUTPUT WITH INTEGRATED CALCULATOR	pulse output: pulse 24 V, DC, 1 pulse=0.01, 0. 1, 1, 10 or 100 m <sup>3</sup> current interface: (0)4 - 20 mA = 0 - x Nm <sup>3</sup> /h , status output for sensor break detection: 24 V, DC standard: DIN 1343, DIN 6358, DIN ISO 2533, DIN 102/ISO 1-1975 fixed value temperature: -50 °C to 200°C fixed value absolute pressure: -0,8 bar to 100 bar		
ATEX CERTIFICATION			
BALL VALVE (OPTIONAL)	AVF - ball valve (blocking valve) for GD 300 removal/installation of the platinum wire sensor without emptying the system		
			

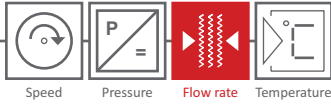

## Flow / Pressure Loss

The diagram applies to gases with a density of air at NTP (0°C and 1013 mbar). The decrease of pressure is always proportional to the gas density. If e.g. the operating pressure rises by 100% the pressure drop doubles.

### Flow rate vs. pressure loss

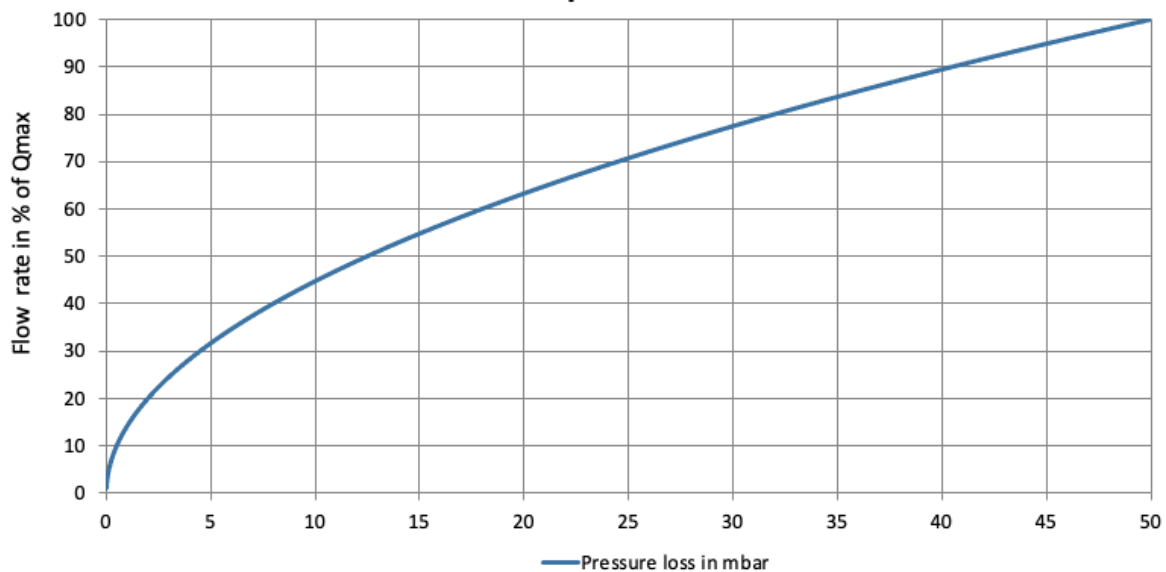

## Accuracy of Measurement

At low flow rates the density (or actually the viscosity) of the gas influences the accuracy.

Above the limit value ( $Q_L$ ), the accuracy is 1,5 % of the measured value. Below  $Q_L$  the accuracy is 5 % of the measured value.

Example measurement range:  
 $Q_L$  with 1,5% accuracy

DN (mm)	inches	m <sup>3</sup> /h		kg/Nm <sup>3</sup>	m <sup>3</sup> /h	
		$Q_{min}$ (5%)	$Q_L$ (1,5%)	density	%	$Q_{max}$
15	1/2"	0,06	3,52	0,5	16	22
80	3"	8,00	64	1,0	8	800
80	3"	8,00	48	1,2	6	800
150	6"	30,0	240	1,0	8	3.000
150	6"	30,0	180	1,2	6	3.000

Example:

At a density of  $x$  kg/m<sup>3</sup> the limit value is  $Q_L = y$  % of  $Q_{max}$ .

density kg/m <sup>3</sup>	=	limit value $Q_L$
0,5	=	16%
1,0	=	8%
1,2	=	6%
2,0	=	4%
4,0	=	2%
8,0	=	1%

For natural gas with a methane component of 85 % a density of 0,85 kg/m<sup>3</sup> is assumed.

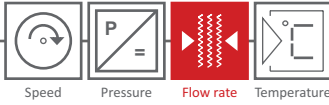

## Measuring Range

### GD 300 (Ex) with intermediate flange, wafer / sandwich

DN (mm)	m <sup>3</sup> /h					
	orifice 13		orifice 15		orifice 17	
	Q <sub>min</sub>	Q <sub>max</sub>	Q <sub>min</sub>	Q <sub>max</sub>	Q <sub>min</sub>	Q <sub>max</sub>
25	0,20	20	0,35	35	0,7	70
32	0,2	20	0,6	60	1,00	100
40	0,20	20	0,90	90	2,00	200
50	0,20	20	1,10	110	2,50	250
65	0,90	90	1,70	170	4,50	450
80	1,40	140	4,50	450	8,00	800
100	2,70	270	6,50	650	10,00	1.000
125	4,00	400	8,00	800	15,00	1.500
150	6,00	600	12,00	1.200	30,00	3.000
200	12,00	1.200	25,00	2.500	60,00	6.000
250	20,00	2.000	40,00	4.000	75,00	7.500
300	30,00	3.000	50,00	5.000	113,00	13.000
350	40,00	4.000	70,00	7.000	140,00	14.000
400	50,00	5.000	100,00	10.000	160,00	16.000

### GD 300 (Ex) with flange

DN (mm)	m <sup>3</sup> /h					
	orifice 13		orifice 15		orifice 17	
	Q <sub>min</sub>	Q <sub>max</sub>	Q <sub>min</sub>	Q <sub>max</sub>	Q <sub>min</sub>	Q <sub>max</sub>
40	0,20	20	0,90	90	2,00	200
50	0,20	20	1,10	110	2,50	250
65	0,90	90	1,70	170	4,50	450
80	1,40	140	4,50	450	8,00	800

DN (mm)	m <sup>3</sup> /h					
	orifice 25		orifice 27		orifice 30	
	Q <sub>min</sub>	Q <sub>max</sub>	Q <sub>min</sub>	Q <sub>max</sub>	Q <sub>min</sub>	Q <sub>max</sub>
100	2,70	270	6,50	650	10,00	1.000
125	4,00	400	8,00	800	15,00	1.500
150	6,00	600	12,00	1.200	30,00	3.000
200	12,00	1.200	25,00	2.500	60,00	6.000
250	20,00	2.000	40,00	4.000	75,00	7.500
300	30,00	3.000	50,00	5.000	113,00	13.000
350	40,00	4.000	70,00	7.000	140,00	14.000
400	50,00	5.000	100,00	10.000	160,00	16.000



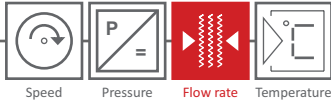

## GD 500 (Ex) with external pipe thread

DN (mm)	inches	m <sup>3</sup> /h	
		Q <sub>min</sub>	Q <sub>max</sub>
15	1/2"	0,06	22
25	1"	0,06	22

## Dimensions and Weight

### GD 300 (Ex) with intermediate flange, wafer / sandwich

mm <sup>+0-1</sup> DN (nominal size)	mm <sup>+0-1</sup> D (Außendurchmesser)	weight (kg) <sup>±5%</sup> material meas. head: aluminum	weight (kg) <sup>±5%</sup> material meas. head: stainless steel 1.4404
25	70,50	4,10	10,10
32	81,00	5,50	10,50
40	91,00	6,00	11,00
50	105,50	6,75	11,75
65	126,00	7,90	12,90
80	142,00	9,00	14,00
100	161,00	9,30	14,30
125	191,00	11,00	16,00
150	217,00	12,30	17,30
200	272,00	16,00	21,00
250	327,00	19,40	24,40
300	377,00	21,258	26,25
350	437,00	23,50	28,50
400	488,00	26,80	31,50

Rev.-no.: GD 300-DS 312 E-V2.3 2021-10-26

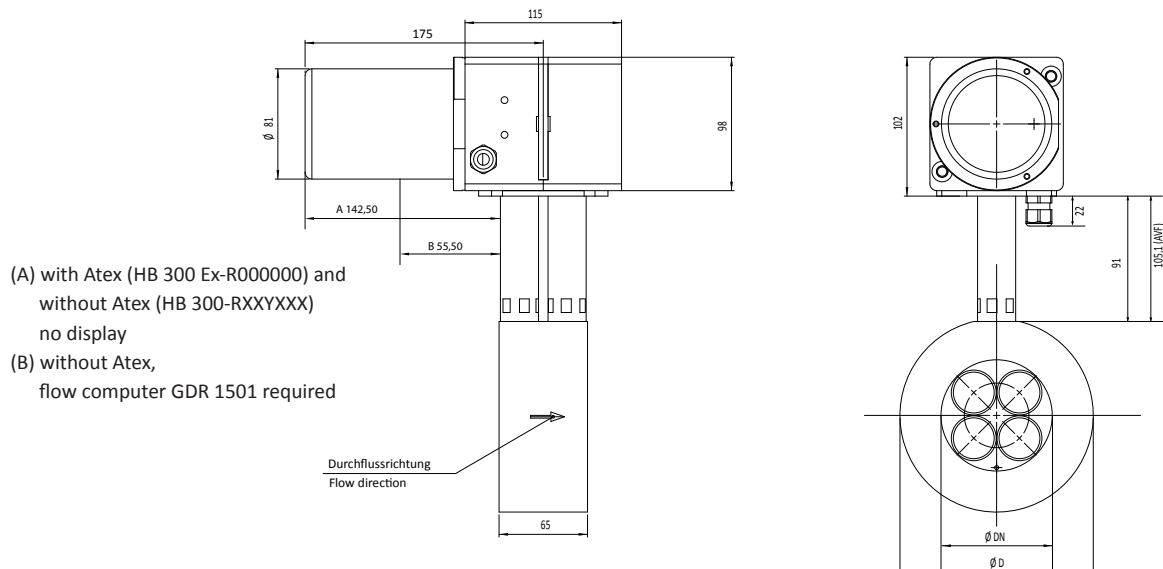

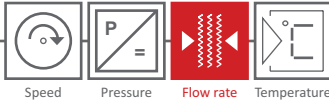

## GD 300 (Ex) with flange

mm <sup>+0-1</sup> DN (nominal size)	mm <sup>+0-1</sup> L (S/L)	mm <sup>+0-1</sup> D	mm <sup>+0-1</sup> D <sub>H</sub>	weight (kg) ±5 % reduced flange	weight (kg) ±5 % solid flange
40	300	150	105	11,00	13,00
50	300	165	125	14,00	16,00
65	300	185	145	14,00	16,00
80	300	200	160	16,00/18,00	17,00/18,00
100	300/360	220	180	17,00	19,00
125	300	250	210	21,00/24,00	29,00/31,00
150	350/500	285	240	25,00	35,00
200	350	340	295	35,00	49,00
250	450	405	355	41,00	51,00
300	500	460	410	55,00	68,00
350	500	520	470	70,00	91,00
400	500	580	525	85,00	110,00

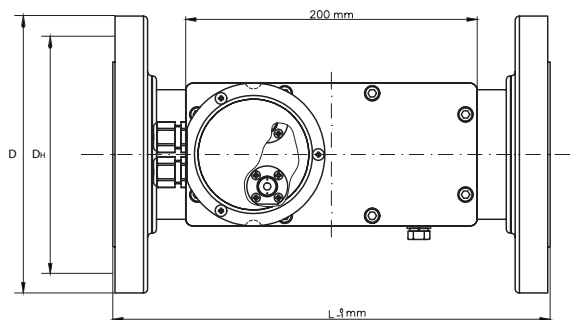
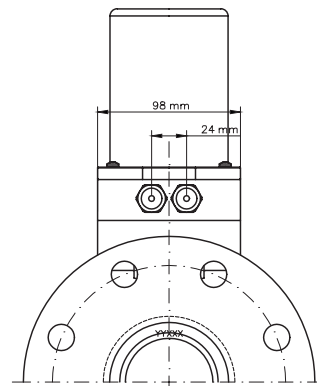
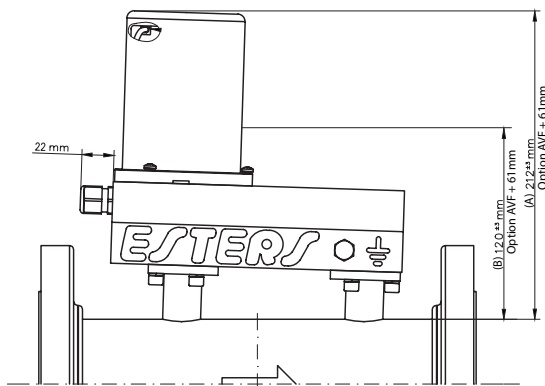

- (A) with Atex (HB 300 Ex-R000000) and without Atex (HB 300-RXXYXXX) no display
- (B) without Atex, flow computer GDR 1501 required

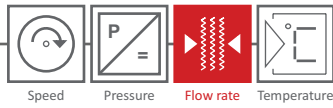

### GD 500 (Ex) with external pipe thread

DN (mm)	inches	weight (Kg) <sup>±5%</sup> aluminum	weight (kg) <sup>±5%</sup> stainless steel
15	R 1/2"	4,00	8,00
25	G 1"	4,00	8,00

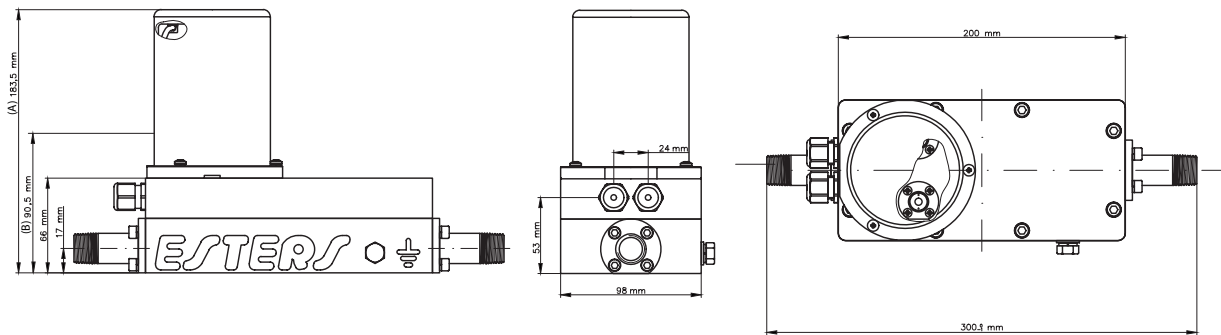

- (A) with Atex (HB 300 Ex-R000000) and without Atex (HB 300-RXXYXXX) no display
- (B) without Atex, flow computer GDR 1501 required

Rev.-no.: GD 300-DS 312 E-V2.3 2021-10-26

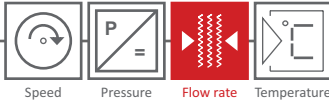

## Project planning

### Decision tree for compiling the measurement solution

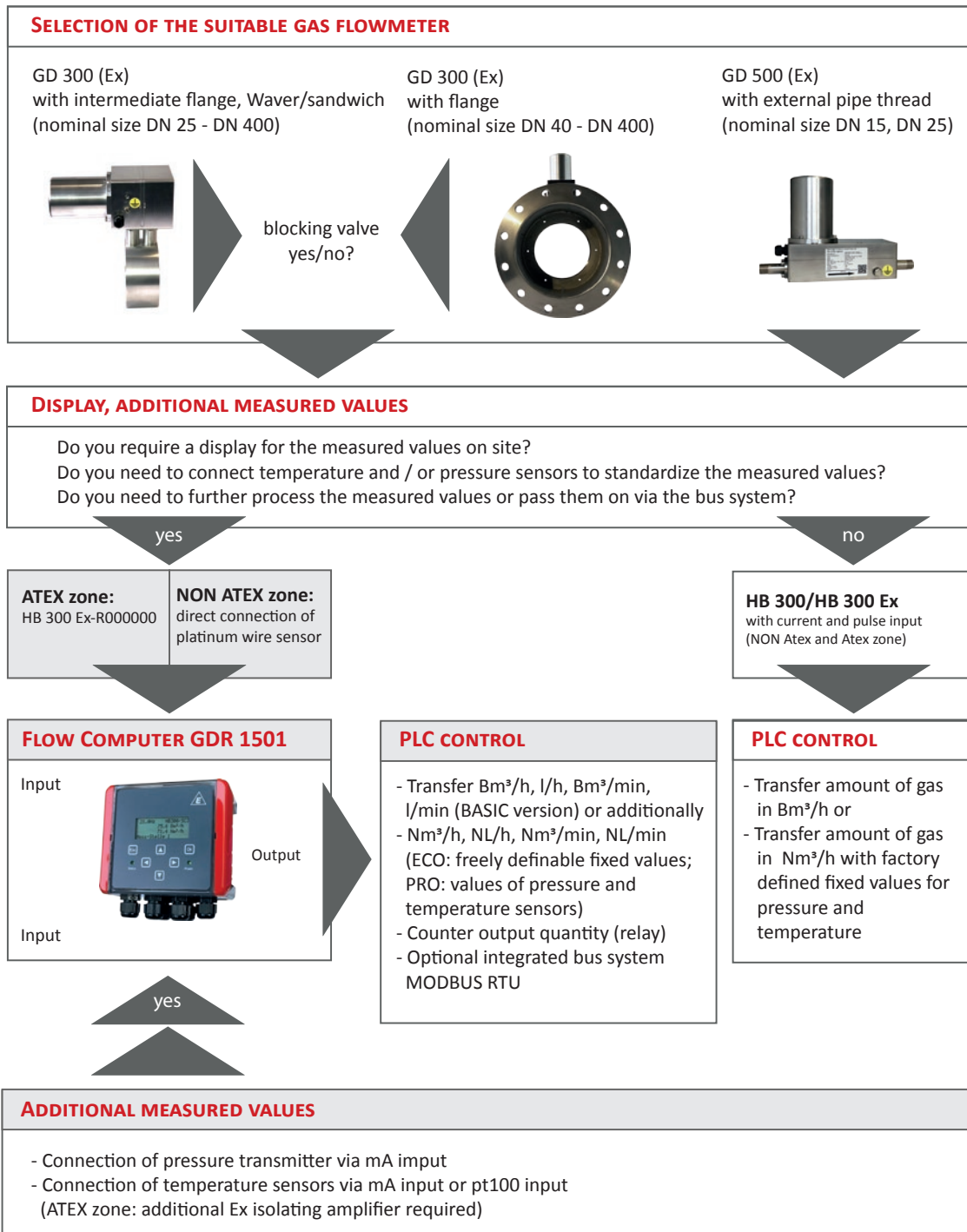

Rev.-no.: GD 300-DS 312 E-V2.3 2021-10-26

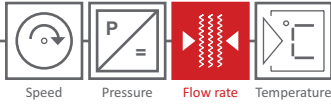

Speed Pressure Flow rate Temperature

## Installation Instructions / Maintenance

The following points must be observed when configuring:

- Ensured that the pipe width is not increased by the gas meter to avoid measurement errors.
- The defined measurement ranges for individual nominal diameters must not be exceeded.
- In case of falling below the  $Q_{\min}$  (measuring range) display of measured values is not possible.
- In the pipe network in front of the flowmeter, the gas velocity may not exceed supersonic speed.
- Supercritical pressure drops and pulsating flows must be avoided.
- GD 300 (Ex) with flange: A straight inlet zone of 10 x DN and an outlet zone of 5 x DN is required.
- GD 300 (Ex) with wafer: A straight inlet and outlet zone of 2,5 x DN is required.
- The flow meter GD 300 (Ex) with flange / GD 500 (Ex) can be installed in horizontal or vertical position. A condensate discharge is integrated into the measuring head, which guarantees the outflow of condensate of 100 % moist gas without sediments.

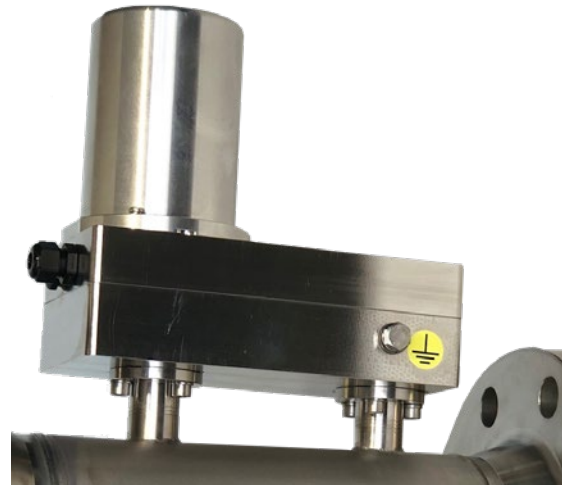

- The inclined measuring head ensures the outflow of condensate when installed in horizontal pipes.
- When installing the GD 300 (Ex) with flange and the GD 500 (Ex) in combination with a long lid. It must be ensured that between the lid and object above, such as ceiling or other pipes, a distance of at least 25 cm from the lid to the object must be complied, otherwise the lid cannot be removed to connect the sensor cable or installing a new sensor.
- The GD 300 (Ex) with a wafer connection and a its cover on the left, a corresponding minimum distance of 25 cm must be observed with a long lid.
- The oscillating measuring method of the Fluidistor principle requires no moving parts or sensitive sensor materials, creating a virtually maintenance-free operation of the GD 300 (Ex) / GD 500 (Ex).
- The platinum wire sensor which is integrated in the head can be exchanged without removing the device from the pipe.
- A sensor change has no effect on the calibration of the flowmeter.



Installation of the GD 300 (Ex) in a vertically falling pipeline

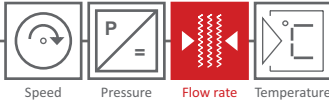

## Ordering Information

GD 300 (Ex) - DN 25 to DN 400  
with intermediate flange, wafer / sandwich  
installation length 65 mm



GD 300				DESCRIPTION
EX-VERSION	Ex			with ATEX certification
NOMINAL SIZE	-025			DN 25
	-032			DN 32
	-040			DN 40
	-050			DN 50
	-065			DN 65
	-080			DN 80
	-100			DN 100
	-125			DN 125
	-150			DN 150
	-200			DN 200
	-250			DN 250
	-300			DN 300
	-350			DN 350
	-400			DN 400
ORIFICE		13		measurement range see table page 8
		15		
		17		
PROCESS CONNECTION			WA	intermediate flange (wafer / sandwich)
PRESSURE RANGE			00	0,5 bar
			10	10 bar
			16	16 bar
MATERIAL CONNECTION			-V4	stainless steel 1.4404
MATERIAL MEAS. HEAD				-AL aluminum
				-V4 stainless steel 1.4404
BALL VALVE				without
				-AVF ball valve (blocking valve)

Rev.-no.: GD 300-DS 312 E-V2.3 2021-10-26



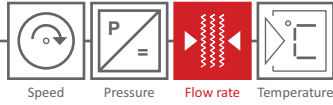

## GD 300 (Ex) - DN 50 to DN 80 with flange



GD 300						DESCRIPTION
EX-VERSION	Ex					with ATEX certification
NOMINAL SIZE	-040					DN 40
	-050					DN 50
	-065					DN 65
	-080					DN 80
ORIFICE		13				measurement range see table page 8
		15				
		17				
PIPE LENGTH			S			standard pipe length
			L			version with extra length, see dimensions
PROCESS CONNECTION			I			flange acc. to DIN EN-192-2/DIN2576
			A			flange acc. to ASME B 16.5
FLANGE VERSION				R		reduced flange (only ISO flange with a pressure range up to PN 10, bolt circle diameter PN 10)
				F		solid flange
BOLT CIRCLE DIAMETER					10	standard (ISO flange)
					16	(ISO flange)
					20	class 150 (ASME flange)
					50	class 300 (ASME flange)
PRESSURE RANGE					00	0,5 bar
					10	10 bar
					16	16 bar
					40	40 bar
					20	class 150 (ASME flange)
					50	class 300 (ASME flange)
MATERIAL MEAS. HEAD					-AL	aluminium
					-V4	V4A stainless steel
BALL VALVE					-PORO	
					-AVF	without ball valve (blocking valve)

Rev.-no.: GD 300-DS 312 E-V2.3 2021-10-26

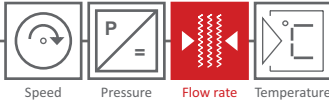

## GD 300 (Ex) - DN 100 to DN 400 with flange



GD 300							DESCRIPTION
EX-VERSION	Ex						with ATEX certification
NOMINAL SIZE	-100						DN 100
	-125						DN 125
	-150						DN 150
	-200						DN 200
	-250						DN 250
	-300						DN 300
	-350						DN 350
-400						DN 400	
ORIFICE		25					measurement range see table page 8
		27					
		30					
PIPE LENGTH			S				standard pipe length
			L				version with extra length, see dimensions
PROCESS CONNECTION			I				flange acc. to DIN EN-192-2/DIN2576
			A				flange acc. to ASME B 16.5
FLANGE VERSION				R			reduced flange (only ISO flange with a pressure range up to PN 10, bolt circle diameter PN 10)
				F			solid flange
BOLT CIRCLE DIAMETER					10		standard (ISO flange)
					16		(ISO flange)
					20		class 150 (ASME flange)
					50		class 300 (ASME flange)
PRESSURE RANGE					00		0,5 bar
					10		10 bar
					16		16 bar
					40		40 bar
					20		class 150 (ASME flange)
					50		class 300 (ASME-flange)
MATERIAL MEAS. HEAD						-AL	aluminium
						-V4	V4A stainless steel
						-PORO	
BALL VALVE							without
							-AVF ball valve (blocking valve)

Rev.-no.: GD 300-DS 312 E-V2.3 2021-10-26

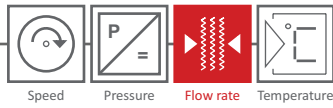

## GD 500 (Ex) with external pipe thread



GD 500						DESCRIPTION
EX-VERSION	Ex					with ATEX certification
PROCESS CONNECTION		-PA1				R 1/2"
		-PA2				G 1"
PRESSURE RANGE			00			0,5 bar
			10			10 bar
			16			16 bar
			40			40 bar
MATERIAL CONNECTION			-V4			V4A stainless steel
MATERIAL MEASURING HEAD				-AL		aluminium
				-V4		V4A stainless steel
					-PORO	

Rev.-no.: GD 300-DS 312 E-V2.3 2021-10-26

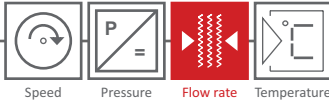

## HB 300 (Ex) - integrated calculator in the measuring head of the GD 300 (Ex) / GD 500 (Ex)

The gas flow meter GD 300 (Ex) / GD 500 (Ex) can be equipped with an integrated calculator in the measuring head. This calculator HB 300 (Ex) converts the m<sup>3</sup>/h to Nm<sup>3</sup>/h in conjunction with pressure (fixed value) and temperature (fixed value).

Using the current output the measured value is directly transferred to a superior PLC system. In the ATEX zone (HB 300 Ex) the signal is transferred using the native pulse output to the external flow computer GDR 1501 for application specific functions.



HB 300				DESCRIPTION
EX-VERSION	Ex			with ATEX certification
STANDARDISATION	-R00			without standardisation
	-R01			DIN 1343
	-R02			DIN 6358
	-R03			DIN ISO 2533
	-R04			DIN 102/ISO 1-1975
CURRENT OUTPUT		0		without current output
		1		0 - 20 mA, load resistance 500 Ohm
		2		4 - 20 mA, load resistance 500 Ohm
OUTPUT RANGE			00	without current output
CURRENT OUTPUT			01	0 - 5 m <sup>3</sup> /h or Nm <sup>3</sup> /h
0 (4) - 20 mA			02	0 - 10 m <sup>3</sup> /h or Nm <sup>3</sup> /h
			03	0 - 20 m <sup>3</sup> /h or Nm <sup>3</sup> /h
			04	0 - 50 m <sup>3</sup> /h or Nm <sup>3</sup> /h
			05	0 - 100 m <sup>3</sup> /h or Nm <sup>3</sup> /h
			06	0 - 200 m <sup>3</sup> /h or Nm <sup>3</sup> /h
			07	0 - 400 m <sup>3</sup> /h or Nm <sup>3</sup> /h
			08	0 - 800 m <sup>3</sup> /h or Nm <sup>3</sup> /h
			09	0 - 1.000 m <sup>3</sup> /h or Nm <sup>3</sup> /h
			10	0 - 1.500 m <sup>3</sup> /h or Nm <sup>3</sup> /h
			11	0 - 2.000 m <sup>3</sup> /h or Nm <sup>3</sup> /h
			12	0 - 3.000 m <sup>3</sup> /h or Nm <sup>3</sup> /h
			13	0 - 5.000 m <sup>3</sup> /h or Nm <sup>3</sup> /h
			14	0 - 7.000 m <sup>3</sup> /h or Nm <sup>3</sup> /h
			15	0 - 10.000 m <sup>3</sup> /h or Nm <sup>3</sup> /h
PULSE WEIGHTING			0	pulse output (standard)
			3	0,01 m <sup>3</sup> or Nm <sup>3</sup>
			4	0,1 m <sup>3</sup> or Nm <sup>3</sup>
			5	1 m <sup>3</sup> or Nm <sup>3</sup>
			6	10 m <sup>3</sup> or Nm <sup>3</sup>
			7	100 m <sup>3</sup> or Nm <sup>3</sup>
			8	1.000 m <sup>3</sup> or Nm <sup>3</sup>

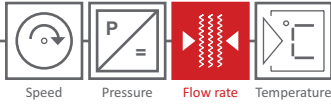

## External Flow Computer GDR 1501

The connection of an external volume corrector of the GDR 1501 series enables additional use of the determined measured values via additional functions.

The volume corrector is used to calculate the current gas volume. The current amount of gas can be displayed in cubic meters or liters on an hourly or minute basis. Here are some special features of the device series:



GD 300 with Waver connection and GDR 1501 (NON-ATEX zone)

- 4-line display of 20 characters
- Multilingual menu (german, english, italian, french, spanish, more in progress)
- Capacitive and wear-free touch keypad
- Full device configuration via touch keypad, no additional software required
- Protection of the configuration via security code
- Recording of essential actions with time stamp in the system logbook (device start, sensor failure, overrange, etc.)
- Easy and fast cable connection thanks to tool-free push-in connections
- Housing material made of UV-resistant polycarbonate, protection class: IP 65
- Persistent meter reading for 5 years
- Integrated real-time clock, battery buffered over 5 years
- Einbindung von Druck- und Temperaturwerte über Festwertdefinition oder
- Connection of pressure and temperature sensors via two current inputs
- Standardization according to DIN 1343, DIN 6358, DIN ISO 2533, DIN 102/ISO 1-1975
- Freely scalable current output for the current flow
- Adjustable pulse weighting (0.1, 1 or 10 or 100 m<sup>3</sup> per pulse)
- Optional datatransfer via Modbus RTU

Further details are available in the datasheets of the device series!

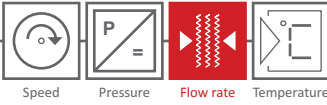

Speed Pressure Flow rate Temperature

## Technical gases - industrial gases

Quantity measurement of carbon dioxide (fermentation and cooling), argon (steel production), nitrogen, oxygen and natural gas (burner control, supply control of the boiler)

The Fluidistor also works with changing gas mixtures!



## Sewage, mine, landfill and biogas

Sewage gas: Contamination and high water vapor saturation of the gas results with other measurement principles to erroneous measurements at the digester..

Biogas: Humidity and sulfur loads of several 100 ppm lead to measurement errors.

The Fluidistor is the functioning alternative!

## Medical gases

Consumption measurement of oxygen, nitrous oxide, xenon, nitrogen, medical carbon dioxide and helium from total stand up to the healthcare beds or operating room with the Fluidistor

