

# I N S T R U C T I O N   M A N U A L

F O R

HYDROSTATIC LEVEL MEASUREMENT

LEVEL CONTROLLER

MODEL: P L D 1 2 0 / P L D 1 3 0

M P 2 0 0 0



Revision    2015-03-09



---

**Read and understand this manual for safe usage.**

- This manual describes the product of standard specification. Read the other manual for the product of explosion-proof specification.
- This manual describes the handling, inspection and adjustment of the product whose model is mentioned on the cover page. Read and understand this manual before handling.
- Follow the additional document and/or direction, submitted by NOHKEN INC. and our distributor or agent, even if the terms are mentioned in this manual.
- Save this manual in a proper place being available to refer to immediately.
- The specification of product mentioned in this manual may not be satisfied by the condition of environment and usage. Check and consider carefully before using.
- Contact to sales office at NOHKEN INC. for any question or comment about this manual and product.

The following are the description of the terms in this manual.

 <b>WARNING</b>	Indicates a potentially hazardous situation which, if not paid attention to, could result in death, serious injury or serious disaster.
 <b>CAUTION</b>	Indicates a hazardous situation which, if not paid attention to, may result in minor or moderate injury or damage to the device.

	Indicates a prohibited matter. The explanation with this mark shall be followed.
	Indicates an instructed matter. The explanation with this mark shall be followed.

## WARNING

This product is not explosion-proof construction. Do not install this product to the place where the flammable gas or vapor occurs. If installed, the flammable gas or vapor may be ignited, and serious disaster may occur. Use the product of explosion-proof construction in this case.

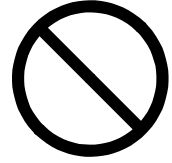

Do not modify or disassemble the product. Otherwise, the product and connected device may be malfunctioned, damaged, fired, or minor injury and electric shock may occur.  
(Follow the additional document and/or direction, submitted by NOHKEN INC. and our distributor or agent.)



Turn off the power, before wiring and inspection.  
Otherwise, electric leakage, fire caused by short circuit, and electric shock may occur.



Ensure the wire is properly connected. The product and connected device may be malfunctioned, damaged, fired, or minor injury and electric shock may occur by improper wiring.



Turn off the power immediately, if the smoke, strange smell and sound occur. Do not use it until the problem is solved.



## CAUTION

Avoid strong shock and rough handling to this product. The product may be damaged by strong shock such as dropping, falling, throwing, knocking, lugging, etc.

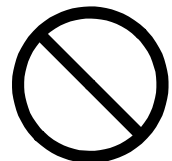

Follow the specification of operating temperature, operating pressure, switch rating, etc. Otherwise, the product and connected device may be malfunctioned, damaged, fired, or minor injury and electric shock may occur. Check the manual or specification sheet.



Operation test shall be done before practical usage. If the serious accident is expected to occur by malfunction of the product, the other operating principle of product shall be installed in parallel.



 CAUTION

Check and deeply consider the chemical compatibility for the material of product in advance.



Do not use the sensor or keep it in stock where the corrosive gas such as  $\text{NH}_3$ ,  $\text{SO}_2$ ,  $\text{Cl}_2$ , etc. is occurred.  
The corrosive atmosphere can enter into the sensor inside through the vent on the housing.



Earth terminal shall be grounded to JIS Class D ground (earth resistance less than  $100\Omega$ ). If not grounded, electric shock may occur by any accident.



Provide arrester or surge absorber to avoid electrical impact such as lightning and static electricity. If not provided, the product and connected device may be malfunctioned, damaged, and fired, or minor injury and electric shock may occur.



## **INTRODUCTION**

- A) This manual specifies the specification of a general product.  
If you order a special product, some details of specification may be different with the manual.
- B) We are glad to suggest and advise for Model selection and chemical resistance of material, but final decision has to be made by the customer.
- C) This manual has been prepared with close attention. Ask sales office at NOHKEN INC. for any question or comment about the contents of this manual.
- D) For replacement parts  
The quality of product has frequently improved, so same spare parts may not be supplied. In this case, replacement parts or products may be supplied. Ask sales office at NOHKEN INC. for details.
- E) The contents of this manual are subject to change any time without notice due to the improvement of the product.

## **WARRANTY & DISCLAIMER**

- A) NOHKEN INC. warrants this product against defect in design, material and workmanship for a period of 1(one) year from the date of original factory shipment.
- B) The warranty only covers the damage of products. The secondary and third kind disasters are not covered by NOHKEN INC.
- C) NOHKEN INC. shall not be liable for the following.
  - C-a) Do not follow the description and direction in this manual.
  - C-b) Damage due to improper installation, wiring, usage, maintenance, inspection, storing, etc.
  - C-c) Repair and modification are done by the person who is not an employee of NOHKEN INC. and our distributor or agent.
  - C-d) Improper parts are used and replaced.
  - C-e) The damage is occurred by the device or machine except our products.
  - C-f) Improper usage. (See "Purpose of use" in chapter 1 in this manual)
  - C-g) Force Majeure including, but not limited to, fire, earthquake, tsunami, lightning, riots, revolution, war, radioactive pollution, acts of God, acts of government or governmental authorities, compliance with law, regulation, and order.

**THE TERMS OF WARRANTY AND DISCLAIMER SHALL IN NO WAY LIMIT YOUR LEGAL RIGHTS.**

---

## Table of Contents

---

<b>1. PURPOSE OF USE</b>	.....	1
<b>2. DESCRIPTION</b>	.....	1
2.1 Description	.....	1
2.2 Principle of operation	.....	1
<b>3. SPECIFICATIONS</b>	.....	1
3.1 Model numbering	.....	1
3.2 Specification	.....	2
<b>4. HANDLING NOTES</b>	.....	4
<b>5. INSTALLATION</b>	.....	5
5.1 Unpacking	.....	5
5.2 Installation	.....	6
<b>6. WIRING</b>	.....	9
6.1 Before wiring	.....	9
6.2 Wiring	.....	9
6.3 Operation check	.....	10
<b>7. PART NAMES AND FUNCTIONS</b>	.....	11
<b>8. OPERATION</b>	.....	12
8.1 Operation	.....	12
8.2 Setting of level controller	.....	14
8.3 Contents of parameter	.....	18
8.4 Error message	.....	35
8.5 Parameter list	.....	36
<b>9. MAINTENANCE AND INSPECTION</b>	.....	37
9.1 Preparation	.....	37
9.2 Maintenance and inspection for the sensor	.....	37
9.3 Maintenance and inspection for the level controller	.....	38
9.4 Replacing the sensor (**)	.....	
<b>10. STORING</b>	.....	39
10.1 Storing for the sensor	.....	39
10.2 Storing for the level controller	.....	39
<b>11. TROUBLESHOOTING</b>	.....	40
<b>12. GLOSSARY</b>	.....	41

---

\*\* See the attached “Replacement Procedure” for replacement of the sensor and the cable.

# 1. PURPOSE OF USE

PLD series level instruments are to measure a water level of a pond, dam, or river.

Do not use them for any other purpose.

Also, do not use them to measure liquids that can corrode the wetted parts material.

# 2. DESCRIPTION

## 2.1 Description

Just by suspending them in the measured liquid, the PLD series sensors start continuous measurement of liquid pressure and convert it to an electrical signal which is proportional to the liquid level. The PLD series sensors comprise a semiconductor pressure sensor\*, and without moving parts, they can achieve a long working life. The sensor cable integrates an air hose for pressure regulation to automatically correct the error due to the change in atmospheric pressure.

## 2.2 Principle of operation

The pressure receiver at the end of sensor detects liquid pressure, and the semiconductor pressure sensor continuously converts it to an electrical signal proportional to liquid level. The air hose is integrated in the sensor cable to automatically correct the measurement error due to the change in atmospheric pressure.

The level controller MP2000 supply voltage to PLD120 and PLD130, receive, amplify and regulate signals from the sensors to give a 4 to 20mA DC output and an alarm relay output. The sensor integrates a test signal circuit to check the control circuit without changing the liquid level.

# 3. SPECIFICATIONS

## 3.1 Model numbering

### (1) Sensor

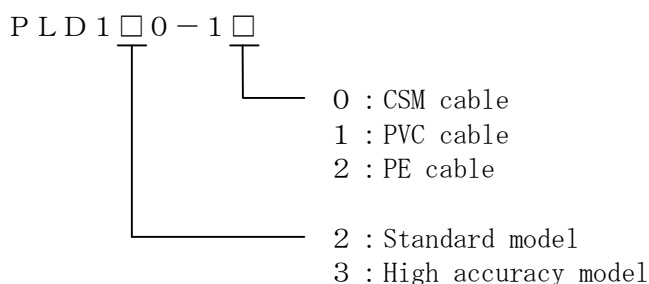

### (2) Level controller

MP 2 0 0 0

\* Refer to the glossary (Page 41).

### 3.2 Specification

#### 3.2.1 Sensor

Model	PLD120-1□	PLD130-1□
Measured object	Water, noncorrosive liquids	
Operating characteristics		
Range	0 to 5, 10, 35, 100m	0 to 5, 10m
Accuracy	±0.2% F.S. (including hysteresis* and repeatability*)	±0.1% F.S. B.S.L.*
Temperature characteristics	±0.015% F.S./°C	
Electric characteristics		
Power supply	14 to 30V DC	
Output	4 to 20mA DC (over F.S. of each range above)	
Mechanical characteristics		
Pressure	twice the full scale	
Cable pull-down force	PVC or CSM sheathed cable: 1kN PE sheathed cable : 700N	
Environmental		
Working temperature	0 to +50°C	
Protection class	IP68 or equivalent (wetted parts)	
Lightening protection	13kV(1.2/50 μS), 6.5kA(8/20 μS)	
Material		
Housing	316 Stainless steel	
Diaphragm*	316L Stainless steel	
Dimensions		
Sensor	φ 34×H220	
Cable	CSM sheathed: 4×0.3mm <sup>2</sup> (O.D. 12mm Max.)	
	PVC sheathed: 2×0.3mm <sup>2</sup> (O.D. 12mm Max.)	
	PE sheathed : 2×0.5mm <sup>2</sup> (O.D. 12mm Max.)	
Mass		
Sensor	Approx. 900g	
Cable	CSM sheathed: approx. 160g/m	
	PVC sheathed: approx. 150g/m	
	PE sheathed : approx. 110g/m	
Others		
Diaphragm location	15mm from the end	
Arrestor	Gap arrestor*, semiconductor surge absorber*	
Cable length	100m Max.	
Separation distance	1km Max.	

\* Refer to the glossary (Page 41).



### 3.2.2 Level controller

Model		MP2000-1		
Operation characteristics	Accuracy	Input/Output	$\pm 0.5\%$ F.S.	
		Display	$\pm 0.3\%$ F.S. $\pm 1$ digit	
	Digits		-9999 to 9999	
	Sampling cycle		Approx. 0.3 seconds	
Electrical characteristics	Power supply		100 to 240V AC $\pm 10\%$ , 50/60Hz	
	Power consumption		20VA Max.	
	Input signal		4 to 20mA DC	
	Output signal		4 to 20mA DC	
	Allowable resistive load		600 $\Omega$ Max.	
	Alarm	Number of contact	4 $\times$ SPDT (HH, H:common, LL, L:common)	
		Contact rating	240V 3A AC (Resistive load) 30V 3A DC (Resistive load)	
	Insulation resistance		100M $\Omega$ or more, 500V DC (Between power terminal and earth terminal) 50M $\Omega$ or more, 250V DC (Between input terminal and output terminal)	
Withstand voltage		1500V AC, 1 minute (Between power terminal and earth terminal) 500V AC, 1 minute (Between input terminal and output terminal)		
Environment	Working temperature		-5 to +50 $^{\circ}$ C (Get rid of dew)	
	Working humidity		85%RH Max.	
Protection class			Non drip-proof enclosure	
Others	Material	Body	ABS	
		Front panel	PET	
		Fittings	ABS	
		Mounting screws	Stainless steel	
	Dimension		H96mm $\times$ W96mm $\times$ D132mm (Except fittings) (Panel depth:120mm)	
	Mounting		Panel mounting DIN 43 700-96 $\times$ 96 (Panel cut-out: W92mm $\times$ H92mm)	
	Mass		Approx. 520g (Except fittings)	

## 4. HANDLING NOTES

Observe instructions below when handling the sensor and level controller, or operation failure or user injury can result.

<p>Sensor and level controller are precision instruments. Do not drop, throw, drag or give strong shock to them, or they can be damaged.</p>	
<p>Carry the sensor with care not to apply force to the cable.</p>	
<p>Avoid storing in a place that is wet, highly humid or exposed to direct sunlight.</p>	
<p>Avoid a wet place when placing the sensor on a floor or ground, or water can ingress into the housing to cause insulation failure.</p>	
<p>Avoid storing or using the sensor in corrosive atmosphere (NH<sub>3</sub>, SO<sub>2</sub>, Cl<sub>2</sub>). Otherwise such atmosphere can ingress into the housing to damage the inside components.</p>	
<p>Protect from rain by covering the instruments with polyethylene sheet, for example. Store the instruments indoors, in a cabinet or where water drops will not enter.</p>	
<p>Do not close the hollow pipe of sensor cable, but protect the pipe from entry of water, dust or bugs.</p>	
<p>When using the sensor or level controller after storing for more than one year, perform operation test to ensure correct operation.</p>	
<p>To avoid personal injury, JIS class D grounding (less than 100Ω) should be done.</p>	
<p>Key switches on the front panel are cushion switches. Push them surely.</p>	
<p>Do not push the front panel with sharp objects.</p>	
<p>When cleaning, softly wipe the panel surface with a dry cloth. Do not use alcohol or other solvent.</p>	

# 5. INSTALLATION

## ⚠ CAUTION

PLD sensors and level controllers are not approved for use in a hazardous area. Do not use them in areas where flammable or explosive gases are present. 

### 5.1 Unpacking

- (1) Open the package and take out the sensor and level controller.
- (2) Sensor and level controller are precision instruments. Do not drop, throw, drag or give strong shock to avoid damaging them.
- (3) Do not place anything on the sensor, or the cable can be damaged or broken.
- (4) Do not place anything on the level controller, or it can be deformed or damaged due to the force applied.
- (5) Check against nameplate to ensure the instruments are as ordered. If not, please contact our sales office.
- (6) Check the instruments for damage. If any, it can be caused during transportation. Please contact our sales office.

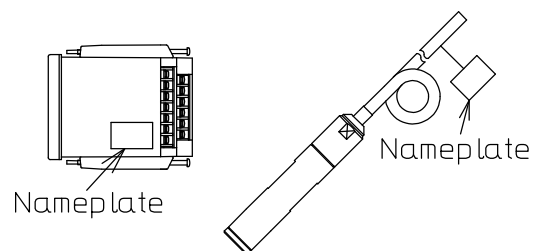
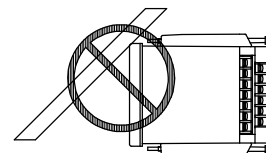
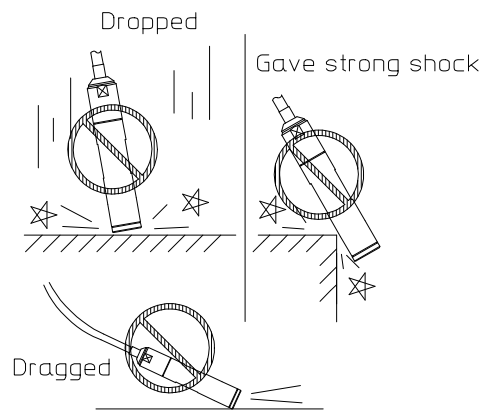
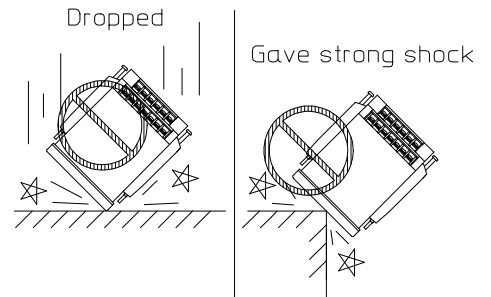

## 5.2 Installation

### 5.2.1 Notes for installing the sensor

- (1) Mount the sensor as far from the liquid outlet as possible.
- (2) Mount the sensor so that the sensor end (pressure receiver) comes as close to the tank bottom as possible. The sensor can not measure levels below the receiver and regards them as 0m.
- (3) Ensure the sensor can easily be removed for maintenance
- (4) Provide a waveguide when the sensor is mounted in a place where massive inflow or turbulence are expected.
- (5) Do not weld the sensor.
- (6) Use the shortest possible cable to connect the sensor and the level controller. To prevent induction or other affection, run the cable at least 50cm away from power lines, or in a conduit or a duct.
- (7) Lower the sensor slowly with extra care so that it does not crush into or touch the tank wall.
- (8) Gently immerse the sensor in liquid.
- (9) Be careful not to damage the cable.
- (10) When the sensor is under water, move the cable lightly up and down to release air trapped at the end of the sensor.  
After ensuring bubbles come up, position the sensor at the specified point and secure the cable.
- (11) Do not fix the sensor cable too tightly with a cable tie. The cable integrates a pressure equalization hose. Fixing too tightly can close the hose and cause measurement error.
- (12) Ensure the end of the pressure equalization hose is not blocked.
- (13) Use a lightening arrestor when the sensor is mounted outdoors or far from the level controller, although the sensor incorporates a protection circuit.
- (14) In human waste or sewage applications where corrosive gases can be generated, ensure such gases do not enter the sensor inside through the pressure equalization hose, by using a junction box for example.
  - (a) Use an air tight junction box in a corrosive atmosphere.
  - (b) Provide a hole for pressure equalization on a junction box in a non-corrosive atmosphere.

### 5.2.2 Mounting the sensor

Determine the mounting location, and slowly lower the sensor to the point where it is to be fixed. Fix the sensor, for example, by winding the cable around the pipe and fixing it with a tying band (Fig.5-1). There are other ways to fix the sensor. Whichever way you are to take, observe the “notes for installing the sensor”.

Note:

Zero point on sensor is at 15mm above the sensor end. Mount the sensor so that the zero level comes to the zero point on sensor.

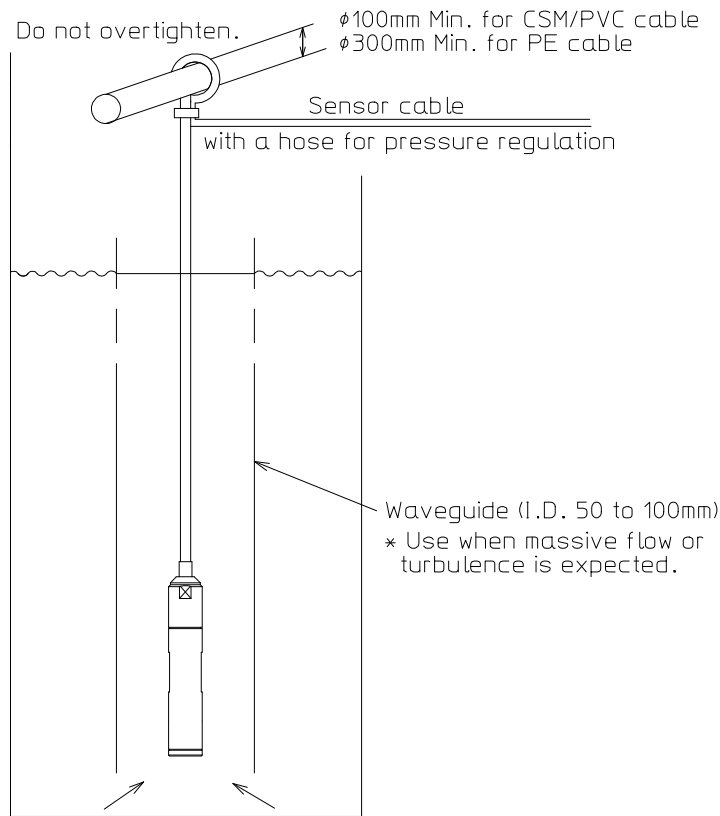

Fig.5-1 Mounting example

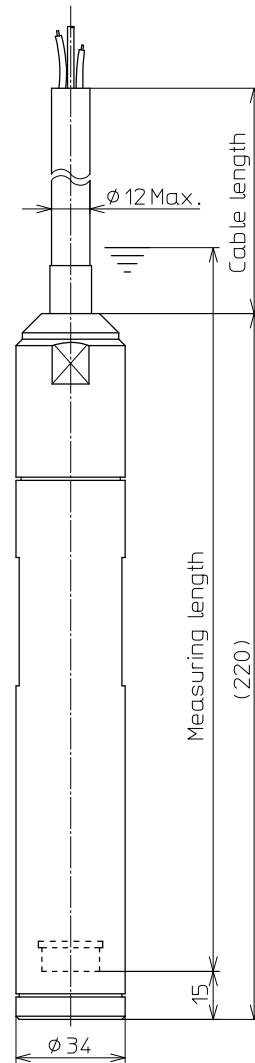

Fig.5-2 Outline

### 5.2.3 Notes for installing the level controller

#### ⚠ CAUTION

The products are shipped with a protective film on the front panel. Remove the film before use. Left on for a long period, glue on the film will not be removed completely to reduce the screen clarity.

Ensure large enough space for mounting and maintenance of the level controller. Follow the instructions below, or operation failure can result.

- (1) Use the level controller in the following environment:  
 Ambient temperature: -5 to +50°C  
 Humidity: 85% RH or lower (no condensation)
- (2) Use the shortest possible cable to connect the sensor and the level controller. To prevent induction or other affection, run the cable at least 50cm away from power lines, or in a conduit or a duct.
- (3) The level controller weighs approximately 520g. Reinforce the panel if it is too weak to support the level controller.
- (4) Level controller is not drip-proofed. Avoid exposure to rain or other water.

### 5.2.4 Mounting the level controller

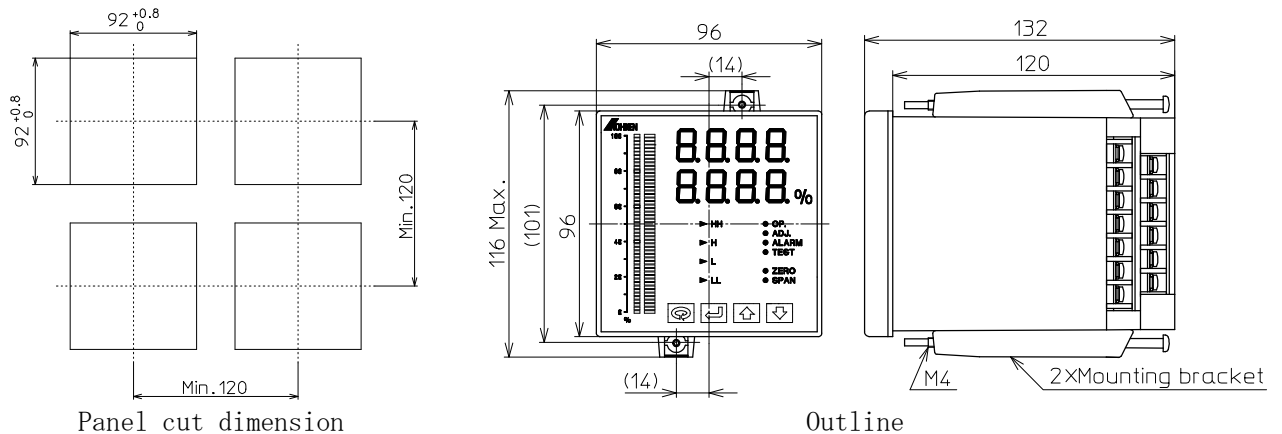

- (1) Drill the mounting panel to mount the level controller. See the following figure for dimensions and mounting pitches.
- (2) Insert the level controller from the front panel.
- (3) Install mounting brackets into the body of the level controller from the back side of the mounting panel. See the following figure for mounting procedures.
- (4) Tighten mounting brackets with the Phillips screwdriver surely.













## 6. WIRING

### 6.1 Before wiring

Disconnect power to the cable used for the level controller.

 <b>WARNING</b>	
Disconnect power before wiring, or electric shock, leakage, ignition or short circuit can result.	

### 6.2 Wiring

 <b>CAUTION</b>	
Ground the earth terminal of the level controller properly, with ground resistance of 100Ω Max.	
To minimize noise affection, rout signal cable with the shortest possible distance and away from power cable. If necessary, provide a noise filter to the power supply.	
The shielded cable for both input and output line shall be one-point grounded. Two-point grounding may cause malfunction.	
Ensure a proper voltage before supplying power to the level controller. Supplying voltage outside the rating can cause operation failure, or damage the level controller.	
The resistance of output signal (4 to 20mA) is 600 Ω Max. Resistance greater than 600 Ω can cause incorrect output signals, or other operation failure.	
Contact rating for relay output is 240V 3A AC or 30V 3A DC. Provide external relays when exceeding.	
When electrical surges are produced, provide appropriate surge absorber or protective circuit.	
Secure the terminal cover after wiring is complete to protect the user from receiving the electric shock while the level controller is powered.	

Observe the following for wiring.

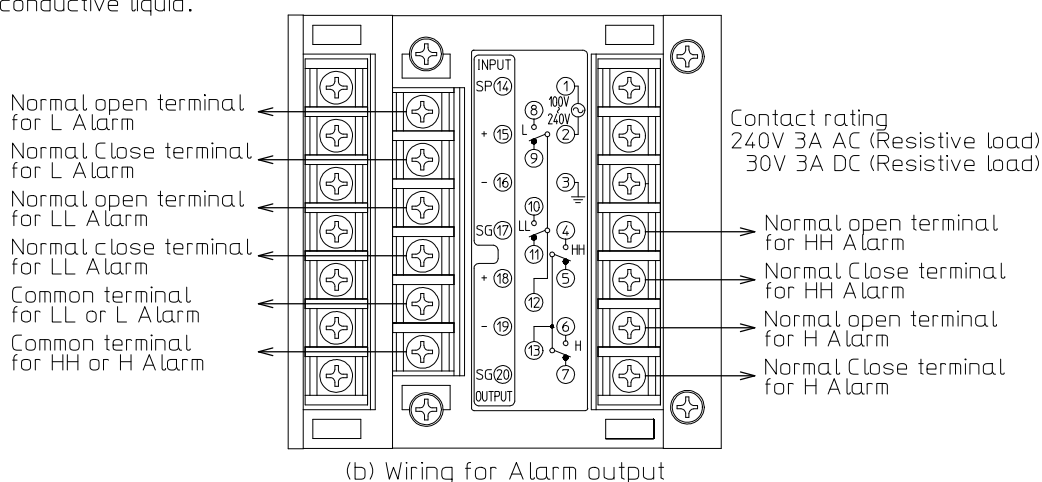
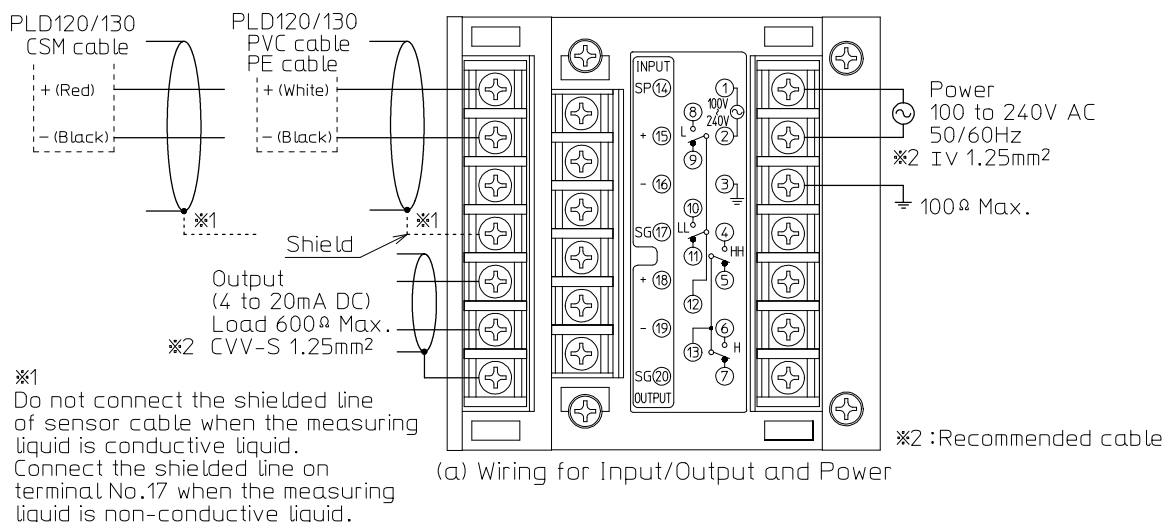

Fail-safe mode is programmable for alarm outputs.

Relay operations are completely changed when you choose the fail-safe mode.

The default is without fail-safe mode. See the below table for operating differences.

Power	Liquid level	Fail-safe mode		Without fail-safe mode	
		Operation		Operation	
		Up ON	Down ON	Up ON	Down ON
ON	Set point or higher				
ON	Set point or lower				
OFF	—				

Relay operation

Always use a tool to tighten the terminal screws.

Screws on the level controller terminal block are of M3.5.

Use cable lug of R1.25-3.5. After wiring, place the cover.

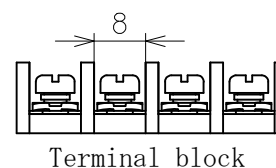

### 6.3 Operation check

Ensure the level controller operation in the test stage. If the operation is unsuccessful, check wiring, read this manual again, or contact our sales department.



## 7. PART NAMES AND FUNCTIONS

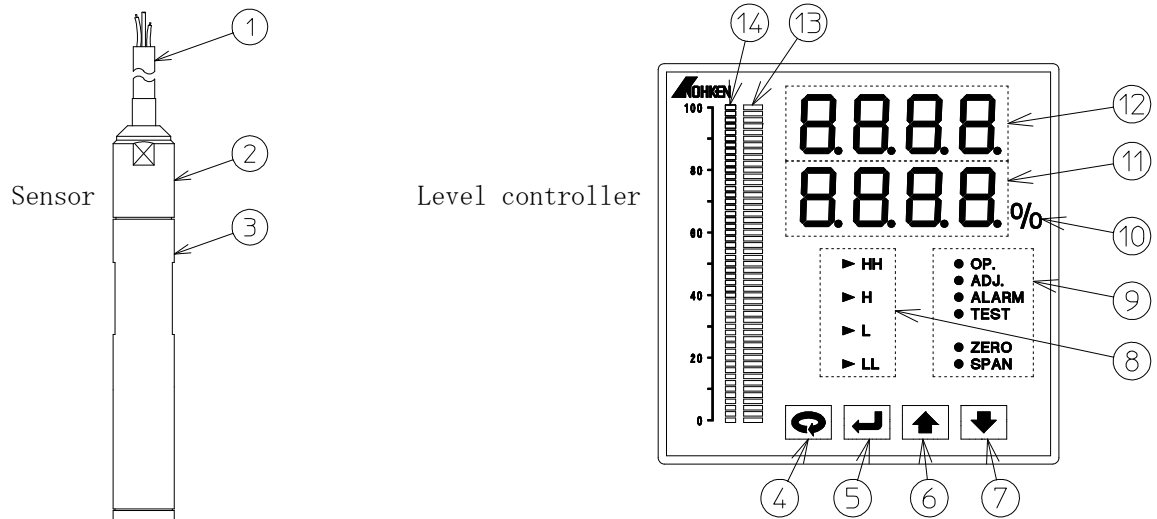

No.	Name	Function	
①	Cable	Integrates pressure regulating air hose.	
②	Cap	Integrates cable connector.	
③	Housing	Integrates semiconductor pressure sensor.	
④	Mode key	Used to change the items to be set.	
⑤	Enter key	Enters the data value.	
⑥	Up key	Used to change the data value.	
⑦	Down key	Used to change the data value.	
⑧	Alarm	HH	Lights while HH set.
		H	Lights while H set.
		L	Lights while L set.
		LL	Lights while LL set.
⑨	Mode	OP.	Lights while measurement mode.
		ADJ.	Lights while adjustment mode. (Without zero point mode and span point adjustment mode.)
		ALARM	Lights while alarm setting mode.
		TEST	Lights while test mode.
		ZERO	Lights while zero point adjustment mode.
		SPAN	Lights while span point adjustment mode.
⑩	Unit	Display indication unit. (Choose a use unit from the unit seal and set it.)	
⑪	Variable data	Display process value, characters identifying the data being set and error messages.	
⑫	Parameter data	Display parameter data.	
⑬	Liquid level/contents	Display liquid level/contents	
⑭	Alarm identification	Display alarm identification.	

Flashing value (mode, etc.) is the item currently selected to be changed.

### CAUTION

The products are shipped with a protective film on the front panel.  
Remove the film before use. Left on for a long period, glue on the film will not be removed completely to reduce the screen clarity.

## 8. OPERATION

Level controller operation, setting and calibration are done by depressing the keypad on the front panel as MODE key, ENTER key, UP key, and DOWN key. Once you entered your desired value to the parameter, it will be saved until change or initialization when the level controller is powered up, it automatically starts up the setting mode.

Parameter's value are programmable after changing to the setting mode.

Incidentally, when ordering a sensor and level controller by the set, it sets to the electric current output by 4 to 20mA and 0 to 100 displays in the early stages to zero - the span point.

### 8.1 Operation

The mode composition of level controller is divided into the measurement mode and the setting mode. Measurement mode is the mode which processes the display according to the signal of a sensor, an alarm output, a current signal, etc., and is the mode which operates in the case of use.

Setting mode is the mode which performs a display setup in measurement mode, an alarm output setup, an output test, etc. When dividing a setting mode mainly, it is divided into the following four.

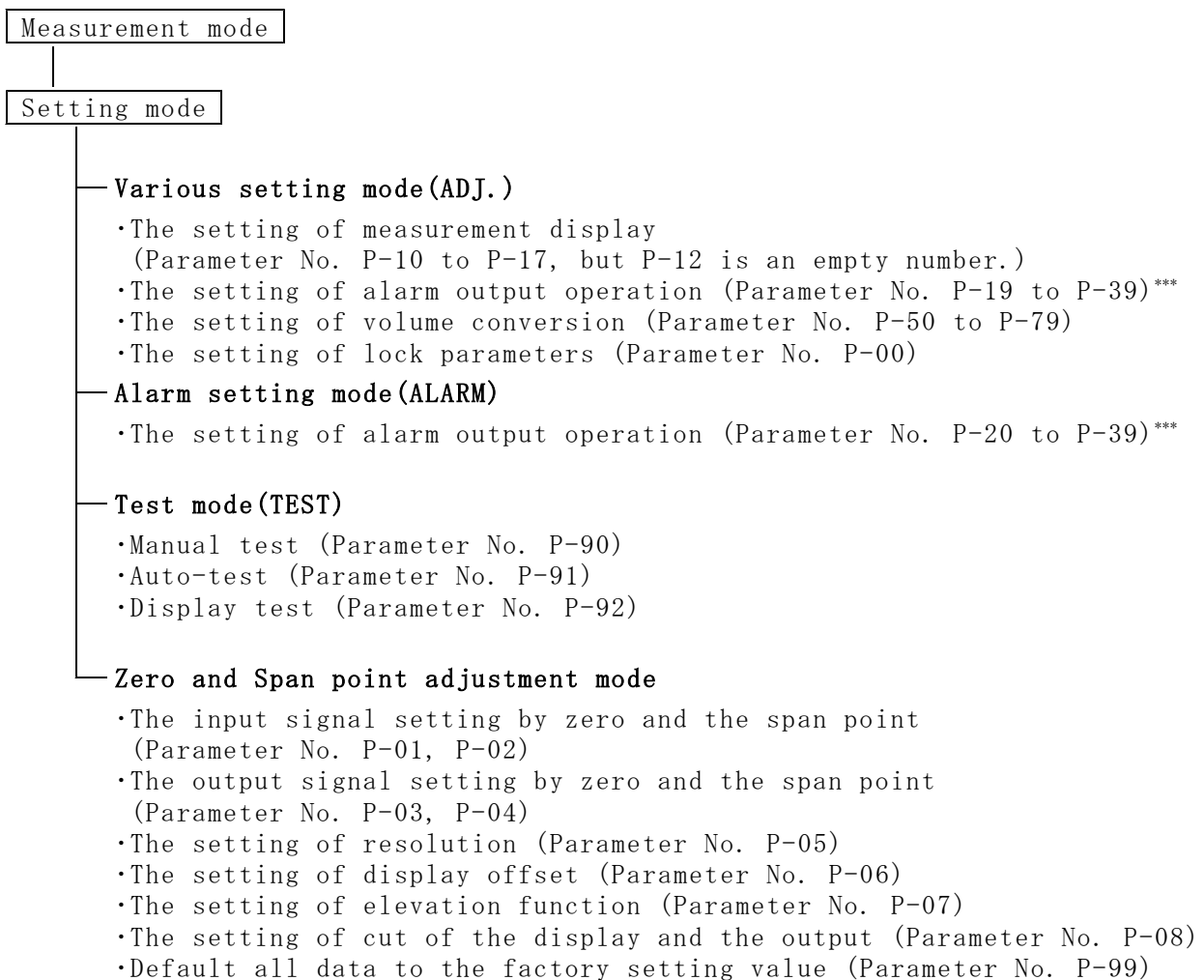

\*\*\* Parameter No. P-20 to P-39 can be changed in either of various setting mode (ADJ.), Alarm setting mode (ALARM).



## 8.2 Setting of level controller

Incidentally, when ordering a sensor and level controller by the set, it sets to the electric current output by 4 to 20mA and 0 to 100 displays in the early stages to zero - span point. Therefore, it is possible to use in basically setting the alarm output to hope for. A way of zero and span point adjustment and the alarm output setting is shown below.

### 8.2.1 Zero and span point adjustment

When ordering a sensor and level controller by the set, zero and span point adjustment has completed in for warding. Therefore, there is not re-adjustment's necessity.









#### Setting example

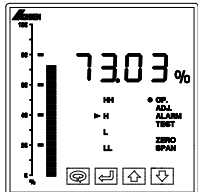

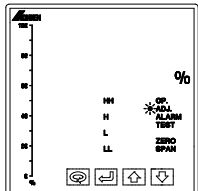

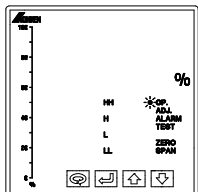

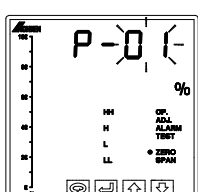



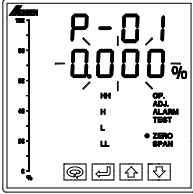

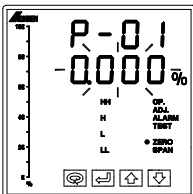

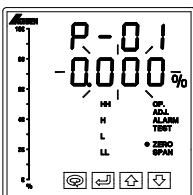

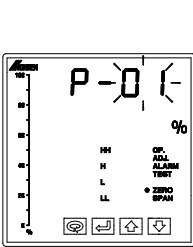

When the necessity which does zero and span point adjustment once again occurs with the size change by the sensor.

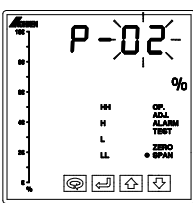

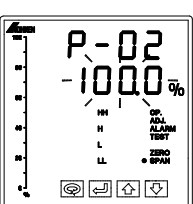

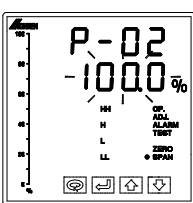

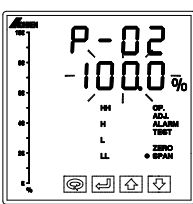

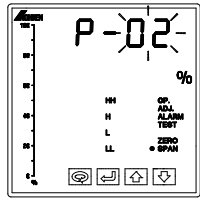

#### Setting contents

- ① It makes a sensor the condition that zero signal and the span point signal can be output.
- ② It makes the condition to output zero signal from the sensor and it does zero adjustment (P-01).
- ③ It makes the condition to output a span point signal from the sensor and it does span point adjustment (P-02).
- ④ It returns a sensor to the measurement condition.

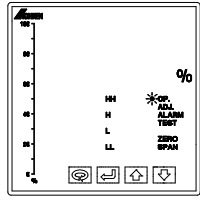
The setting change procedure (The setting change procedure of the above ② and ③)

(1) It begins at the measurement mode.		<div style="border: 1px solid black; padding: 5px;"> <p>Measurement mode "OP." lights.</p> </div>
(2) It pushes  for 3 seconds. "ADJ." blinks.		<p>↓ push  for 3 sec.</p> <div style="border: 1px solid black; padding: 5px;"> <p>Setting mode "ADJ." blinks.</p> </div>
(3) It pushes  . "OP." blinks.		<p>↓ push </p> <div style="border: 1px solid black; padding: 5px;"> <p>"OP." blinks.</p> </div>
(4) It pushes  for 3 seconds. "P-01" blinks. (Zero point adjustment)		<p>↓ push  for 3 sec.</p> <div style="border: 1px solid black; padding: 5px;"> <p>Zero and Span point adjustment mode "P-01" blinks.</p> </div>

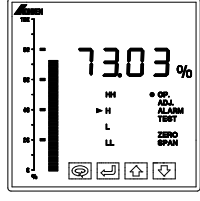
<p>(5) It pushes . The value of the zero point set up now is displayed. (If there is not a process which zero adjusted before in zero position, "0.000" will blink.)</p>		<p>↓ push </p> <p>The value of the zero point set up now is displayed.</p>
<p>(6) <u>It outputs zero point signal from the sensor.</u></p>		<p>↓</p> <p><u>Outputs zero point signal from the sensor</u></p>
<p>(7) In the case except "0.000", push and change  or  into "0.000". {If being "0.000" in (5), this work is unnecessary.}</p>		<p>↓ push  or </p> <p>"0.000" blinks.</p>
<p>(8) It pushes  while the zero point signal had been made to output from a sensor. Then, zero point signal was memorized at the memory and that "P-01" will be in a blink state. (Zero point adjustment's completion)</p>		<p><u>Outputs zero signal</u></p> <p>↓ push </p> <p>Zero point signal was memo-rized at the memory "P-01" blinks.</p>
<p>(9) It pushes . "P-02" blinks. (Span point adjustment)</p>		<p>↓ push </p> <p>"P-02" blinks.</p>
<p>(10) It pushes . The value of the span point set up now is displayed. (If there is not a process which span adjusted before in span position, "100.0" will blink.)</p>		<p>↓ push </p> <p>The value of the span point set up now is displayed.</p>
<p>(11) <u>It outputs span point signal from the sensor.</u></p>		<p>↓</p> <p><u>Outputs span point signal from the sensor</u></p>
<p>(12) In the case except "100.0", push and change  or  into "100.0". {If being "100.0" in (10), this work is unnecessary.}</p>		<p>↓ push  or </p> <p>"100.0" blinks.</p>

<p>(13) It pushes  while the span point signal had been made to output from a sensor. Then, span point signal was memorized at the memory and that "P-02" will be in a blink state. (Span point adjustment's completion)</p>		<p><u>Outputs zero signal</u> ↓ push </p> <p>Span point signal was memorized at the memory "P-02" blinks.</p>
<p>(14) It pushes  or .</p> <p>"OP." blinks.</p>		<p>↓ push  or </p> <p>"OP." blinks.</p>
<p>(15) When pushing , it returns to the measurement mode. (Zero and span point adjustment's completion)</p>		<p>↓ push </p> <p>Measurement mode "OP." lights. (Adjustment's completion)</p>

### 8.2.2 Alarm output setting

As follows, in the early stage setting, because a alarm value is set, when changing into the setting value except this, do this setting.

Since a relay alarm operates as compared with a display value, in case it changes the parameter about display values, such as display offset (P-06) and measurement length (P-14), please re-set up the parameter about the alarm output of P-19 to P-39.





#### Setting example





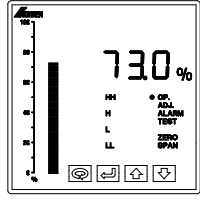

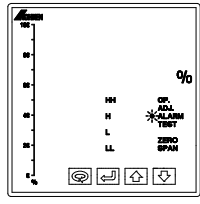



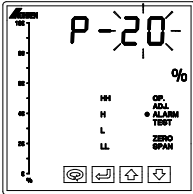

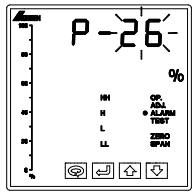

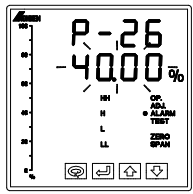



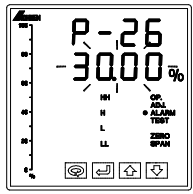



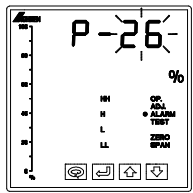

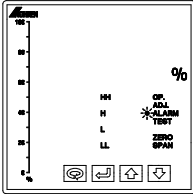
It changes L alarm into ON at less than 30 from ON at less than 40.

#### Setting contents

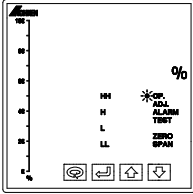
① It changes P-26 (the caution value of the L alarm) into 30.00 from 40.00.

#### The setting change procedure

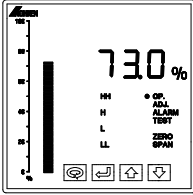
<p>(1) It begins at the measurement mode.</p>		<p>Measurement mode "OP." lights.</p>
<p>(2) It pushes  for 3 seconds. "ADJ." blinks. It pushes . "Alarm." blinks.</p>		<p>↓ push  for 3 sec. push </p> <p>Setting mode "ALARM" blinks.</p>

<p>(3) It pushes . "P-20" blinks.</p>		<p>↓ push </p> <p><b>Alarm setting mode</b> "P-20" blinks. (LL alarm relay operation)</p>
<p>(4)  is pushed several times and please blink "P-26". (L alarm relay setting value)</p>		<p>↓ push  several times</p> <p>"P-26" blinks. (L alarm relay setting value)</p>
<p>(5) It pushes . The setting value set up now is displayed.</p>		<p>↓ push </p> <p>"40.00" blinks.</p>
<p>(6) It pushes  or  several times and it makes display "30.00".</p>		<p>↓ push  or </p> <p>"30.00" blinks.</p>
<p>(7) It pushes . Then, setting value was memorized at the memory and that "P-26" will be in a blink state. (L alarm relay setting value is completion)</p>		<p>↓ push </p> <p>Setting value was memorized at the memory "P-26" blinks.</p>
<p>(8) It pushes . "ALARM" blinks.</p>		<p>↓ push </p> <p>"ALARM" blinks.</p>
<p>(9) It pushes  or . "OP." blinks.</p>		<p>↓ push  or </p> <p>"OP" blinks.</p>
<p>(10) When pushing , it returns to the measurement mode. (Setting change's completion)</p>		<p>↓ push </p> <p><b>Measurement mode</b> "OP." lights. (Setting change's completion)</p>

When changing the other caution value continuously, return to (4) after (7) ends and operate a parameter in the change by the similar procedure.

### 8.3 Contents of parameter

All the parameters of level controller are shown below. Contents about the various setting such as the change operation confirmation test of the change of the way of displaying and the alarm output operation are shown.

#### 8.3.1 Input and output (P-00 to P-17)

P-00. Lock : It prevents from a not carefully depending parameter change.

**【default : 1965】**

Parameter No.00 are called and setting values other than 1965 are inputted. A parameter will be in a lock state and it will become impossible to perform a setup and reference of a parameter.

When canceling a keylock,  is pushed for 3 seconds at the time of measurement mode, and it shifts to the setting mode of a parameter P-00, and a keylock will be canceled if 1965 is inputted into a setting value.

《programmable range : 0000 to 9999》

P-01. Zero point adjustment : The zero point signal of a connection sensor is recognized.

**【default : 0.000】**

It changes into the state where the signal of a connection sensor is inputted, and it is made to recognize by carrying out an input setup that the signal of the connection sensor is an input signal value in the setting position (comparatively at the time of setting the full scale of a sensor signal to 100). (Keep in mind that the error of Err1 will occur if it sets up by the same input signal as the span point input value of P-02.) Refer to the 9.4 clause for the release method. Fundamentally, the input signal of a connection sensor is in the state which inputted the signal in the zero point position of a sensor, and please set up the setting value 0.000.

《programmable range : 0.000 to 200.0》

P-02. Span point adjustment : The span point signal of a connection sensor is recognized.

**【default : 100.0】**

It changes into the state where the signal of a connection sensor is inputted, and it is made to recognize by carrying out an input setup that the signal of the connection sensor is an input signal value in the setting position (comparatively at the time of setting the full scale of a sensor signal to 100). (Keep in mind that the error of Err1 will occur if it sets up by the same input signal as the zero point input value of P-01.) Refer to the 9.4 clause for the release method. Fundamentally, the input signal of a connection sensor is in the state which inputted the signal in the span point position of a sensor, and please set up the setting value 100.0.

《programmable range : 0.000 to 200.0》



P-03. Output for Zero point : The output current value in a zero point  
**【default : 04.00】** position is set up.

《programmable range : 02.00 to 22.00》 [unit : mA DC]

P-04. Output for Span point : The output current value in a Span point  
**【default : 20.00】** position is set up.

《programmable range : 02.00 to 22.00》 [unit : mA DC]

P-05. Resolution : Change display at desired resolution.  
**【default : 0000】**

It is made the output change for every resolution which set up the measurement value and the current output value.

Each resolution = Total measuring range / numbers of resolution  
 "0" means without resolution display.

《programmable range : 0000 to 2000》

P-06. Display value offset : It is used when indicating the display value by  
**【default : 0.000】** offset on the whole. The display which made the center standard zero as main uses is attained.

Setting example

before		It is set up using P-06 as 50.00.	after	
Zero point	display 0.000 output 4.00mA		Zero point	display -50.00 output 4.00mA
Span point	display 100.0 output 20.00mA	Span point	display 50.00 output 20.00mA	

※ Span suppression(P-15):0.000, Measuring range(P-14):100.0,  
 Zero elevation(P-13):0.000

- Please input an input value to become "Display value offset (P-06) < Span suppression(P-15) + measuring range(P-14) + Zero elevation(P-13)."  
 When not satisfied, "Err2" is displayed and it becomes impossible to shift to measurement mode. Refer to the 9.4 clause for the release method.
- Since it is dependent on the numerical value set up by measurement range (P-14), an input value should surely input this parameter after a setup of P-14.
- Since it depends for an alarm setup on a display value, please be sure to reconfirm the parameter setting value about alarm output operation of P-19 to P-39 after a setup.
- This parameter cannot indicate the display value by offset to the measurement mode {P-10 = 1 (deposition volume) or 3 (space volume)} of volume conversion.

《programmable range : 0.000 to 9999》  
 [unit : The unit on a surface panel (arbitrary display units)]

P-07. Elevation function : It is used when making a display value and a  
**【default : 0.000】** current output value slide on the whole.

Setting example

before		It is set up using P-07 as 100.0.	after	
Zero point	display 0.000 output 4.00mA		Zero point	display -1.000 output 3.84mA
Span point	display 100.0 output 20.00mA		Span point	display 99.00 output 19.84mA

※ Span suppression(P-15):0.000, Measuring range(P-14):100.0,  
 Zero elevation(P-13):0.000

- Since it is dependent on the numerical value set up by measurement range (P-14), an input value should surely input this parameter after a setup of P-14.
- Since it depends for an alarm setup on a display value, please be sure to reconfirm the parameter setting value about alarm output operation of P-19 to P-39 after a setup.
- It becomes effective to the total setting value of a setup (P-10) in measurement mode elevation functioning this parameter.

《programmable range : -9999 to 9999》

[unit : The unit on a surface panel (arbitrary display units)]

P-08. Cut function : The display and current output below a zero point and  
**【default : 0】** beyond a span point are cut.

0 : Standard

1 : It cuts below a zero point.

2 : It cuts beyond a span point.

3 : It cuts below a zero point and beyond a span point.

example) Span suppression(P-15)=0.000, Measuring range(P-14)=100.0,  
 Zero elevation(P-13)=0.000. In this setup, if P-08 = 3 are  
 inputted, in below a zero point, as for a display, 0.000 and a  
 current output will be 4.00mA, and, in beyond a span point, as  
 for a display, 100.0 and a current output will be 20.00mA.  
 (A current value shows a calculation value.)

- When this parameter is changed, the measurement mode of volume conversion is also influenced. When a volume conversion setup is carried out, please re-set up the value of P-50 to P-59.

《programmable range : 0 to 3》

P-10. Measuring mode : It chooses a measurement object.

**【default : 0】**

It calculates in the set-up measurement mode and a display, a current output, and an alarm output are performed to an operation result.

A current output full scale serves as the range of measurement range (P-14) in a level display (0 or 2) at the time of selection, and, in selection of a volume display (1 or 3), even a top position serves as a range from a bottom position.

0 : Material level

1 : Material volume

2 : Space level

3 : Space volume

《programmable range : 0 to 3》

P-11. Decimal points : Selectable display decimal points.

**【default : 1】**

0 : no digits after the decimal point

1 : 1 digit after the decimal point

2 : 2 digits after the decimal point

3 : 3 digits after the decimal point

4 : floating point

《programmable range : 0 to 4》

P-13. Zero elevation : The display level from 0% position to the bottom point  
**【default : 0.000】** of a sensor input signal is inputted.

It is used when performing the case where carry out the uniform increase of the material level display value, and it is displayed, and a material volume conversion display.

《programmable range : 0.000 to 9999》  
 [unit : The unit on a surface panel (arbitrary display units)]

P-14. Measuring range : The display level of 0 to 100% position of full-scale  
**【default : 100.0】** one of a sensor input signal is inputted.

The amount of change of a display level is inputted.

《programmable range : 0.000 to 9999》  
 [unit : The unit on a surface panel (arbitrary display units)]

P-15. Span suppression : The amount of display levels from 100% position to  
**【default : 0.000】** the top point of a sensor input signal is inputted.

It is used when performing the case where carry out the uniform increase of the space level display value, and it is displayed, and a space volume conversion display.

《programmable range : 0.000 to 9999》  
 [unit : The unit on a surface panel (arbitrary display units)]

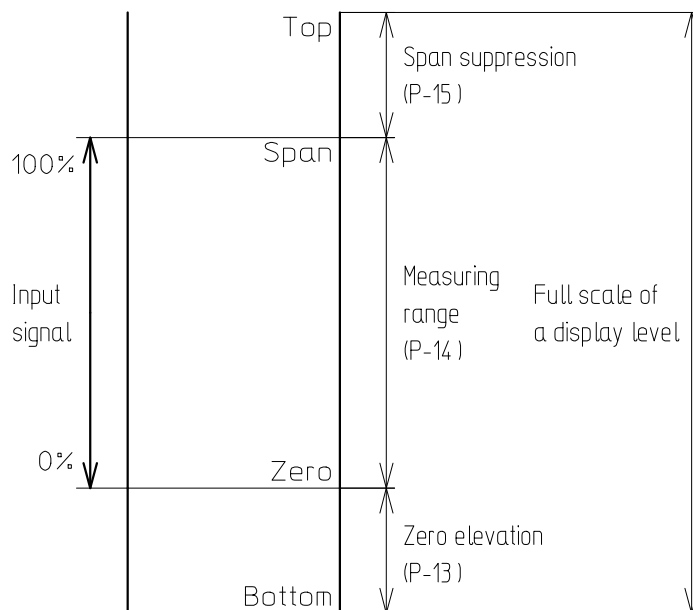

Relation between a parameter setting value and the display value range

P-16. Damping rate : It is useful to delete an excessive change over  
**【default : 5.000】** pre-setting value to avoid accidental outputs.

《programmable range : 0.001 to 100.0》  
 [unit : % (Rate to the full scale of an input signal)]

P-17. Input filter : Input signal equalization.

**【default : 0】**

0 : Equalize 10 signals

(The value which averaged the last measurement value for 10 time is updated and outputted every about 0.3 seconds.)

1 : Equalize 100 signals tracking speed becomes slow

(The last measurement value for 10 time is summarized to one block, and the value which averaged the value of the last block for ten pieces is updated and outputted every about 3 seconds.)

3 : Equalize 30 signals tracking speed becomes slow

(The last measurement value for 10 time is summarized to one block, and the value which averaged the value of the last block for three pieces is updated and outputted every about 3 seconds.)

5 : Equalize 50 signals tracking speed becomes slow

(The last measurement value for 10 time is summarized to one block, and the value which averaged the value of the last block for five pieces is updated and outputted every about 3 seconds.)

7 : Equalize 70 signals tracking speed becomes slow

(The last measurement value for 10 time is summarized to one block, and the value which averaged the value of the last block for seven pieces is updated and outputted every about 3 seconds.)

《programmable range : 0 , 1 , 3 , 5 , 7》

### 8.3.2 Alarm output operation(P-19 to P-39)

(1) Programmable alarm relays with reference to material level of the measuring mode (0 or 1, P-10).

(2) If you choose space level, note to the different display and setting value for alarm points.

	operation	setting value	hysteresis	ON delay timer	OFF delay timer
LL alarm relay	P-20	P-21	P-22	P-23	P-24
L alarm relay	P-25	P-26	P-27	P-28	P-29
H alarm relay	P-30	P-31	P-32	P-33	P-34
HH alarm relay	P-35	P-36	P-37	P-38	P-39

P-19. Fail-safe : Selectable fail-safe operation mode. (Refer to 7.2.)

**【default : 0】**

0 : Fail-safe off

1 : Fail-safe on

《programmable range : 0 , 1》

P-20. LL alarm relay operation : Programmable operation for the LL alarm

**【default : 2】** relay.

0 : OFF (empty)

1 : Close ON rising (normally open)

2 : Close ON falling (normally closed)

《programmable range : 0 to 2》

P-21. LL alarm relay setting value : Key-in desired setting value for the

**【default : 20.00】** LL alarm relay. (A bottom position is inputted as a standard position.)

《programmable range : -9999 to 9999》

[unit : The unit on a surface panel (arbitrary display units)]

P-22. LL alarm relay hysteresis : Key-in desired hysteresis for the LL alarm

**【default : 0.000】** relay.

《programmable range : 0.000 to 9999》

[unit : The unit on a surface panel (arbitrary display units)]

P-23. LL alarm relay ON delay timer : Key-in desired ON state delay time for

**【default : 0】** the LL alarm relay.

《programmable range : 0 to 30》 [unit : seconds]

P-24. LL alarm relay OFF delay timer : Key-in desired OFF state delay time

**【default : 0】** for the LL alarm relay.

《programmable range : 0 to 30》 [unit : seconds]

P-25. L alarm relay operation : Programmable operation for the L alarm relay.

**【default : 2】**

0 : OFF (empty)

1 : Close ON rising (normally open)

2 : Close ON falling (normally closed)

《programmable range : 0 to 2》

P-26. L alarm relay setting value : Key-in desired setting value for the L

**【default : 40.00】**

alarm relay. (A bottom position is  
inputted as a standard position.)

《programmable range : -9999 to 9999》

[unit : The unit on a surface panel (arbitrary display units)]

P-27. L alarm relay hysteresis : Key-in desired hysteresis for the L alarm

**【default : 0.000】**

relay.

《programmable range : 0.000 to 9999》

[unit : The unit on a surface panel (arbitrary display units)]

P-28. L alarm relay ON delay timer : Key-in desired ON state delay time for

**【default : 0】**

the L alarm relay.

《programmable range : 0 to 30》 [unit : seconds]

P-29. L alarm relay OFF delay timer : Key-in desired OFF state delay time for

**【default : 0】**

the L alarm relay.

《programmable range : 0 to 30》 [unit : seconds]

P-30. H alarm relay operation : Programmable operation for the H alarm relay.

**【default : 1】**

0 : OFF (empty)

1 : Close ON rising (normally open)

2 : Close ON falling (normally closed)

《programmable range : 0 to 2》

P-31. H alarm relay setting value : Key-in desired setting value for the H

**【default : 60.00】**

alarm relay. (A bottom position is  
inputted as a standard position.)

《programmable range : -9999 to 9999》

[unit : The unit on a surface panel (arbitrary display units)]

P-32. H alarm relay hysteresis : Key-in desired hysteresis for the H alarm

**【default : 0.000】**

relay.

《programmable range : 0.000 to 9999》

[unit : The unit on a surface panel (arbitrary display units)]

P-33. H alarm relay ON delay timer : Key-in desired ON state delay time for

**【default : 0】**

the H alarm relay.

《programmable range : 0 to 30》 [unit : seconds]

P-34. H alarm relay OFF delay timer : Key-in desired OFF state delay time for

**【default : 0】**

the H alarm relay.

《programmable range : 0 to 30》 [unit : seconds]



P-35. HH alarm relay operation : Programmable operation for the HH alarm  
【default : 1】 relay.

- 0 : OFF (empty)
- 1 : Close ON rising (normally open)
- 2 : Close ON falling (normally closed)

《programmable range : 0 to 2》

P-36. HH alarm relay setting value : Key-in desired setting value for the  
【default : 80.00】 HH alarm relay. (A bottom position is  
inputted as a standard position.)

《programmable range : -9999 to 9999》  
[unit : The unit on a surface panel (arbitrary display units)]

P-37. HH alarm relay hysteresis : Key-in desired hysteresis for the HH alarm  
【default : 0.000】 relay.

《programmable range : 0.000 to 9999》  
[unit : The unit on a surface panel (arbitrary display units)]

P-38. HH alarm relay ON delay timer : Key-in desired ON state delay time for  
【default : 0】 the HH alarm relay.

《programmable range : 0 to 30》 [unit : seconds]

P-39. HH alarm relay OFF delay timer : Key-in desired OFF state delay time  
【default : 0】 for the HH alarm relay.

《programmable range : 0 to 30》 [unit : seconds]

8.3.3 Volume conversion(P-50 to P-59)

- (1) A display is provided which is proportional to the level of the tank for those seven common tank shapes. You just input parameters related to your desired tank shape. We recommend to keep default volume for P-58 (conversion factor "C") and P-59 (Conversion multiplier "P") if unnecessary.
- (2) Total of P-13, P-14, and P-15 should be equal to total length of the tank.
- (3) Choose your suitable tank shape below.

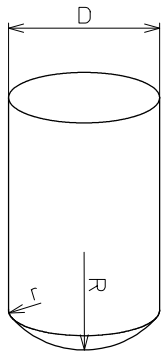

0 : Spherical bottom

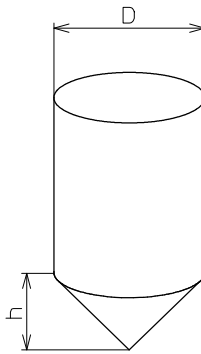

1 : Conic bottom

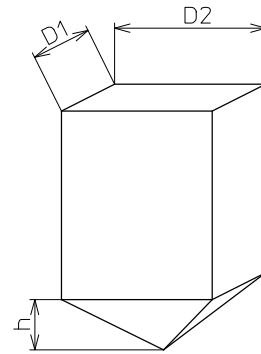

2 : Pyramidal bottom

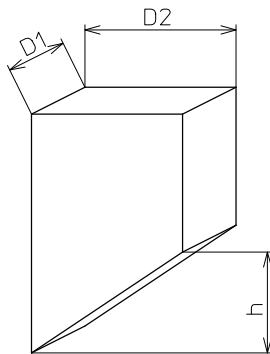

3 : Sloped bottom

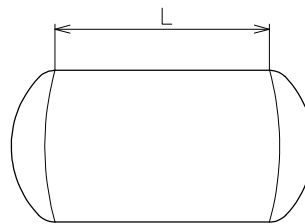

4 : Parabolic ends

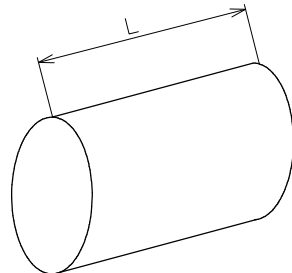

5 : Flat end

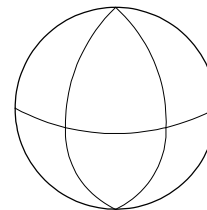

6 : Sphere

The tank form figure and each input size position in capacity conversion

- (4) For the tank number 3, enter carefully to P-55 ("D1") and P-56 ("D2"). Check the correct orientation with the drawing.

(5) Following are automatically converted when you enter the half parabolized end of tank number 4. Since it becomes a factor with error when conditions differ, please examine using a linear display etc.

Diameter of the cylinder:  $DD = (\text{Zero elevation}) + (\text{Measuring range}) + (\text{Span suppression})$

Radius of the half parabolized end: RR

Rounded corner of the half parabolized end: rr (Note: RR:rr = 2:1)

Height of the half parabolized end: hh (Note: hh = 1/4DD)

(6) If capacity conversion are performed, the full scale of a current output will be changed into a top position from a bottom position. Keep in mind that it differs from the case of level conversion (a sensor measurement region is made into a full scale).

P-50. Selectable tank shape : Choose your desired tank from those seven  
【default : 0】 common tank shapes.

When performing a volume conversion setup, it is necessary to change a setup of P-10 (measurement mode) into 1 (or 3) simultaneously.

- 0: Spherical bottom
- 1: Conic bottom
- 2: Pyramidal bottom
- 3: Sloped bottom
- 4: Parabolic ends
- 5: Flat end
- 6: Sphere
- 9: Linear

《programmable range : 0 to 9》

P-51. Tank dimension D : Enter the diameter of the tank if P-50 = 0 or 1.  
【default : 1.000】

《programmable range : 0.000 to 9999》

[unit : The unit inputted by P-14 (measurement range)]

P-52. Tank dimension R : Enter the radius of the parabolic bottom if P-50=0.  
【default : 1.000】

《programmable range : 0.000 to 9999》

[unit : The unit inputted by P-14 (measurement range)]

P-53. Tank dimension r : Enter the radius of rounded ends of the tank if  
【default : 0.100】 P-50 = 0.

《programmable range : 0.000 to 9999》  
[unit : The unit inputted by P-14 (measurement range)]

P-54. Tank dimension h : Enter the height of bottom section of the tank if  
【default : 0.500】 P-50 = 1, 2, 3.

《programmable range : 0.000 to 9999》  
[unit : The unit inputted by P-14 (measurement range)]

P-55. Tank dimension D1 : Enter the depth of tank if P-50 = 2, 3.  
【default : 1.000】

《programmable range : 0.000 to 9999》  
[unit : The unit inputted by P-14 (measurement range)]

P-56. Tank dimension D2 : Enter the depth of tank if P-50 = 2, 3.  
【default : 1.000】

《programmable range : 0.000 to 9999》  
[unit : The unit inputted by P-14 (measurement range)]

P-57. Tank dimension L : Enter the horizontal length of tank if P-50 = 4, 5.  
【default : 1.000】

《programmable range : 0.000 to 9999》  
[unit : The unit inputted by P-14 (measurement range)]

P-58. Conversion factor C : Enter the factor the conversion value to be  
【default : 1.000】 multiplied.

《programmable range : 0.000 to 9999》

P-59. Conversion multiplier P : Enter the multiplier the conversion value  
【default : 0.000】 must be multiplied to  $1 \times 10^{-p}$ .

《programmable range : 0.000 to 9999》

### 8.3.4 Linear profile (P-60 to P-79)

(1) If your tank design does not match one of the seven common tank shapes, it can be programmed as eleven separate breakpoint settings, including zero point and span point.

Parameter number from P-60 to P-79 is those breakpoint settings.

(2) The tank profile is achieved by entering the level (linearization "X") and corresponding volume (linearization "Y") for each breakpoint.

(3) If capacity conversion are performed, the full scale of a current output will be changed into a top position from a bottom position. Keep in mind that it differs from the case of level conversion (a sensor measurement region is made into a full scale).

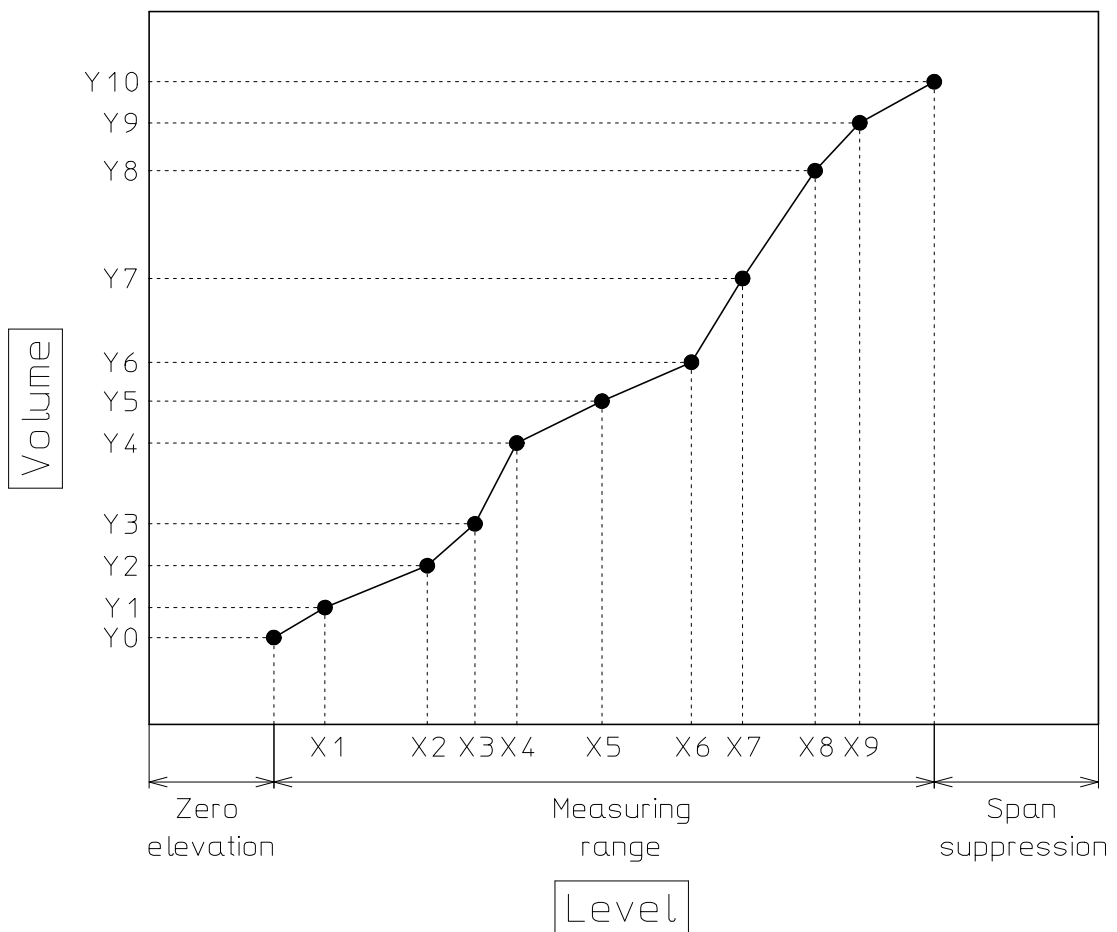

Relation between the linearization "X" and the linearization "Y"

P-60. Level breakpoint X1 : Enter the level data X1.  
【default : 10.00】

P-61. Level breakpoint X2 : Enter the level data X2.  
【default : 20.00】

P-62. Level breakpoint X3 : Enter the level data X3.  
【default : 30.00】

P-63. Level breakpoint X4 : Enter the level data X4.  
【default : 40.00】

P-64. Level breakpoint X5 : Enter the level data X5.  
【default : 50.00】

P-65. Level breakpoint X6 : Enter the level data X6.  
【default : 60.00】

P-66. Level breakpoint X7 : Enter the level data X7.  
【default : 70.00】

P-67. Level breakpoint X8 : Enter the level data X8.  
【default : 80.00】

P-68. Level breakpoint X9 : Enter the level data X9.  
【default : 90.00】

- The range which can be inputted and unit to P-60 to P-68 are as follows.  
《programmable range : 0.000 to 9999》  
[unit : The unit inputted by P-14 (measurement range)]
- In addition, data inputs a value including Zero elevation(P-13) and the Span suppression(P-15).

P-69. Breakpoint volume Y0 : Enter the volume data for Zero point.  
【default : 0.000】

P-70. Breakpoint volume Y1 : Enter the volume data for breakpoint X1.  
【default : 1.000】

P-71. Breakpoint volume Y2 : Enter the volume data for breakpoint X2.  
【default : 2.000】

P-72. Breakpoint volume Y3 : Enter the volume data for breakpoint X3.  
【default : 3.000】

P-73. Breakpoint volume Y4 : Enter the volume data for breakpoint X4.  
【default : 4.000】

P-74. Breakpoint volume Y5 : Enter the volume data for breakpoint X5.  
【default : 5.000】

P-75. Breakpoint volume Y6 : Enter the volume data for breakpoint X6.  
【default : 6.000】

P-76. Breakpoint volume Y7 : Enter the volume data for breakpoint X7.  
【default : 7.000】

P-77. Breakpoint volume Y8 : Enter the volume data for breakpoint X8.  
【default : 8.000】

P-78. Breakpoint volume Y9 : Enter the volume data for breakpoint X9.  
【default : 9.000】

P-79. Breakpoint volume Y10 : Enter the volume data for Span point.  
【default : 10.00】

- The range which can be inputted and unit to P-69 to P-79 are as follows.  
《programmable range : 0.000 to 9999》  
[unit : The unit inputted by P-14 (measurement range)]
- In addition, data inputs a value including Zero elevation(P-13) and the Span suppression(P-15).

### 8.3.5 Check test of operation(P-90 to P-92)

P-90. Manual test mode : Check for output current status and relay output status by entering your desired value in manual.

Output should be in proportional to your input value.



Enter desired numeric value within the range of from Zero to Span.

Do not enter below Zero or over Span.

P-91. Auto-test mode : Output current and relay repeatedly from zero and span.

P-92. Display test : The display test of LED is performed.

"P-92" indication and all display on LED are alternately flashed.

You can check each one segment by depressing . You can check all display at the same time by depressing .

### 8.3.6 Initialization(P-99)

P-99. Initialization : A parameter is returned to a setup of factory  
【default : 1999】 shipments.

Initialize all parameters to default (factory setting) by entering 1965. It returns to the setting value specified when the contents of a parameter of a level controller were specified in advance.

When there is no specification especially, it returns to the initial value of standard of our company.

《programmable range : 0000 to 9999》





#### 8.4 Error message

If an error arises, an error message appears as follows.

Display	Message	Action
b o u t	• Cable of input line is broken	• Wire correctly
	• Input value is overflow	• Check for the rating of input signal. • Check for the operation status of the sensor.
E r r 1	• Improper calibration of Zero or Span	• Re-calibrate. Do not key-in same value for both Zero and Span.
E r r 2	• Measuring computation error	• Check for all input value to correct.
E r r 3	• Internal MPU malfunction	• Ask to our Service department.

To reset system error:

b o u t : Wire correctly for the input line, or repair input signal correctly. (NOTE: bout does not appear when you choose analog input as 4-20 mA DC.)

E r r 1 : Depress + at the same time, and re-calibrate Zero and Span.

E r r 2 : Depress  over 3 seconds, and check for all parameter value.

E r r 3 : Depress + at the same time to delete error message.

If unsuccessful, ask to our Service department.

## 8.5 Parameter list

Please use it as a write-in paper at the time of setting up a parameter.

P-No.	Parameter item	【default】	setting value	P-No.	Parameter item	【default】	setting value
P-01	Zero point adjustment	【0.000】		P-50	Selectable tank shape	【 0 】	
P-02	Span point adjustment	【100.0】		P-51	Tank dimension D	【1.000】	
P-03	Output for Zero point	【04.00】		P-52	Tank dimension R	【1.000】	
P-04	Output for Span point	【20.00】		P-53	Tank dimension r	【0.100】	
P-05	Resolution	【 0 】		P-54	Tank dimension h	【0.500】	
P-06	Display value offset	【0.000】		P-55	Tank dimension D1	【1.000】	
P-07	Elevation function	【0.000】		P-56	Tank dimension D2	【1.000】	
P-08	Cut function	【 0 】		P-57	Tank dimension L	【1.000】	
				P-58	Conversion factor C	【1.000】	
P-10	Measuring mode	【 0 】		P-59	Conversion multiplier P	【0.000】	
P-11	Decimal points	【 1 】					
P-13	Zero elevation	【0.000】		P-60	Level breakpoint X1	【10.00】	
P-14	Measuring range	【100.0】		P-61	Level breakpoint X2	【20.00】	
P-15	Span suppression	【0.000】		P-62	Level breakpoint X3	【30.00】	
P-16	Damping rate	【5.000】		P-63	Level breakpoint X4	【40.00】	
P-17	Input filter	【 0 】		P-64	Level breakpoint X5	【50.00】	
P-19	Fail-safe	【 0 】		P-65	Level breakpoint X6	【60.00】	
				P-66	Level breakpoint X7	【70.00】	
P-20	LL alarm relay operation	【 2 】		P-67	Level breakpoint X8	【80.00】	
P-21	LL alarm relay setting value	【20.00】		P-68	Level breakpoint X9	【90.00】	
P-22	LL alarm relay hysteresis	【0.000】					
P-23	LL alarm relay ON delay timer	【 0 】		P-69	Breakpoint volume Y0	【0.000】	
P-24	LL alarm relay OFF delay timer	【 0 】		P-70	Breakpoint volume Y1	【1.000】	
P-25	L alarm relay operation	【 2 】		P-71	Breakpoint volume Y2	【2.000】	
P-26	L alarm relay setting value	【40.00】		P-72	Breakpoint volume Y3	【3.000】	
P-27	L alarm relay hysteresis	【0.000】		P-73	Breakpoint volume Y4	【4.000】	
P-28	L alarm relay ON delay timer	【 0 】		P-74	Breakpoint volume Y5	【5.000】	
P-29	L alarm relay OFF delay timer	【 0 】		P-75	Breakpoint volume Y6	【6.000】	
P-30	H alarm relay operation	【 1 】		P-76	Breakpoint volume Y7	【7.000】	
P-31	H alarm relay setting value	【60.00】		P-77	Breakpoint volume Y8	【8.000】	
P-32	H alarm relay hysteresis	【0.000】		P-78	Breakpoint volume Y9	【9.000】	
P-33	H alarm relay ON delay timer	【 0 】		P-79	Breakpoint volume Y10	【10.00】	
P-34	H alarm relay OFF delay timer	【 0 】					
P-35	HH alarm relay operation	【 1 】		P-90	Manual test mode		
P-36	HH alarm relay setting value	【80.00】		P-91	Auto-test mode		
P-37	HH alarm relay hysteresis	【0.000】		P-92	Display test		
P-38	HH alarm relay ON delay timer	【 0 】		P-99	Initialization	【1999】	
P-39	HH alarm relay OFF delay timer	【 0 】		P-00	Lock	【1965】	

## 9. MAINTENANCE AND INSPECTION

Perform maintenance and inspection of the sensor once or twice a year. Depending on the measured liquid, temperature or other working conditions, more frequent maintenance is required. Especially, when the liquid includes many dust particles, perform inspection a few times a year.

Note that the sensor is inspected while powered.

### 9.1 Preparation



#### WARNING

Disconnect power before wiring, or electric shock, leakage, ignition or short circuit can result.



- (1) Slowly pull out the sensor from the liquid. Be careful not to make it crush into the tank wall.
- (2) After pulling out the sensor, be careful not to damage the cable.
- (3) Place the sensor in a large enough place to perform maintenance.
- (4) Disconnect power to the cable used for the level controller.

### 9.2 Maintenance and inspection for the sensor



#### CAUTION

When cleaning the sensor, avoid splashing water or applying pressure directly on the diaphragm.



- (1) Check the appearance for damage that may impair correct operation. If such damage is found, repair or replace the components.
- (2) Check the cable and sensor for buildup, and if found, wash it down.
- (3) Check to ensure the terminal and lead wire are properly connected. If loose, properly tighten the terminal screws with a screw driver.
- (4) Check the terminal and lead wire for corrosion. If found, replace the corroded component.
- (5) With the sensor lifted out of the measured liquid, ensure the level controller reads 0 meter or appropriate values.

Then place the sensor in the measured liquid, and lowering the sensor, ensure the controller reads the value corresponding to the level. If incorrect values are displayed, make adjustment again.

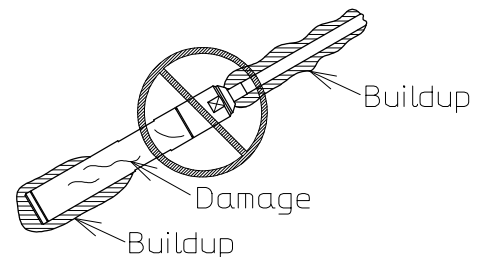

The terminal and lead wire are properly connected.

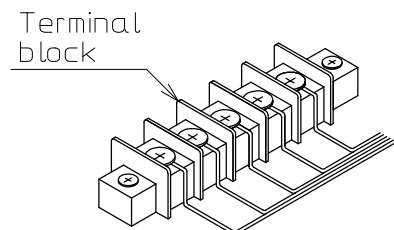

### 9.3 Maintenance and inspection for the level controller

- (1) Switch off power to the level controller, and disconnect all the wiring except the power lines.
- (2) Connect a voltmeter to the power line for the sensor on the level controller (positive to terminal no. 14 and negative to no. 16), and supply power to the level controller. Ensure a voltage of approx. 24V DC on the voltmeter.
- (3) Connect a 4 to 20mA direct current generator to the analog input line of the level controller (positive to terminal no.15, negative to no.16), and supply power. Ensure the level controller displays a value suitable for the input current. Then connect an ammeter to the analog output line (positive to terminal no. 18, negative to no. 19), and ensure the ammeter displays a correct value.
- (4) Connect a digital multi meter (set to measure resistance) to relay terminals, and ensure each contact changes state when the alarm is ON.

### 9.4 Replacing the sensor

Damaged sensor body can be replaced with a new one. Contact our sales office for delivery of the new sensor body.

See the attached "Replacement Procedure" for replacement of the sensor.

# 10. STORING

Observe instructions in the following paragraphs when instruments are not to be used right after delivery and stored, or are removed from service and stored.

Failure to observe the instructions can result in damaging the instruments or cause operation failure.

## 10.1 Storing for the sensor

Store the sensor in the following conditions.

- Temperature: -10 to +60°C
- Humidity: 85%RH Max. (no condensation)
- No vibration
- No corrosive atmosphere (without NH<sub>3</sub>, SO<sub>2</sub>, or Cl<sub>2</sub>)

- (1) Remove buildup if any, or the buildup on sensor housing can become stiff and cause operation failure when used the next time.
- (2) Protect the sensor from rainwater. Leaving the end of sensor cable open can cause rainwater entry into the sensor inside.
- (3) Do not place anything on the sensor, or the cable can be damaged.

## 10.2 Storing for the level controller

Store the level controller in the following conditions.

- Temperature: -5 to +50°C
- Humidity: 85%RH Max. (no condensation)
- No vibration
- No corrosive atmosphere (without NH<sub>3</sub>, SO<sub>2</sub>, or Cl<sub>2</sub>)

- (1) Protect the level controller from rainwater. Level controller is not drip-proofed.
- (2) Do not place anything on the level controller, or it can be deformed due to force applied on it.

Note:

Wrap the instruments with polyethylene sheet and seal it to protect from moisture or dust. If the instruments are stored where temperature change is enormous, place desiccant such as silica gel in the polyethylene sheet.

## 11. TROUBLESHOOTING

### CAUTION

In the event of trouble, perform the following and nothing else.  
If you have any question, please contact our sales office.



Trouble	Possible cause	Corrective action	Reference
No display.	Loose screws at power terminal connections. Wrong wiring.	Wire correctly.	6. Wiring (pp.9 to 10)
	Not powered.	Supply power.	6. Wiring (pp.9 to 10)
Display remain static.	Loose screws at output terminal connections. Wrong wiring.	Wire correctly.	6. Wiring (pp.9 to 10)
	Wrong parameter.	Reset parameter.	8. Operation (pp.12 to 36)
	The clogged air vent port.	Clear the clog.	9. Maintenance and inspection (pp.37 to 38)
No output alarm.	Loose screws at alarm contact terminal connections. Wrong wiring.	Wire correctly.	6. Wiring (pp.9 to 10)
	The alarm setting moved.	Set correctly.	8. Operation (pp.12 to 36)
No output signal.	Loose screws at output terminal connections. Wrong wiring.	Wire correctly.	6. Wiring (pp.9 to 10)
	Cable breakage.	Replace the cable.	Replacement procedure
No change output.	Wrong parameter.	Reset parameter.	8. Operation (pp.12 to 36)
Wrong level.	Unsuitable mounting position.	Check the mounting position and if problem found, change the position.	5. Installation (pp.5 to 8)
	Wrong zero and span point setting.	Perform adjustment.	8. Operation (pp.12 to 36)
	The clogged pressure equalization hose.	Check the cable for bending or the end of the pressure equalization hose for clogging and remove the cause if any.	9. Maintenance and inspection (pp.37 to 38)
Reading fluctuates.	Turbulence.	Provide a waveguide.	5. Installation (pp.5 to 8)
	Cable breakage.	Replace the cable.	Replacement procedure
	Noise affection.	Remove high voltage or current runs.	
	Loose screws at terminal connections.	Wire correctly.	6. Wiring (pp.9 to 10)
Reading exceeds the max. value.	Damaged pressure receiver due to overstress.	Replace the sensor.	Replacement procedure
	Short circuit due to disconnected lead wire.	Remove the cause.	6. Wiring (pp.9 to 10)

## 12. GLOSSARY

Terms used in this manual are defined in the chart below. This chart excludes the terms which have already been defined earlier in this manual.

Semiconductor pressure sensor	Sensor which is made of silicone crystal semiconductor and utilizes the change in resistance depending on applied pressure (piezo-resistance effect).
B. S. L.	Maximum deviation of actual performance relative to a straight line, located such that it minimizes the maximum deviation.
Hysteresis	Difference of output signal when level rises or falls from a level.
Repeatability	Variation of output signals at a level when it is changed a few times.
Diaphragm	316L stainless steel membrane which delivers liquid pressure to the pressure sensor.
Arrester	Element that releases electron.
Surge absorber	Element that protects circuit by reducing its resistance when higher voltage than rating is applied.

# NOHKEN INC.

HEAD OFFICE : 15-29,Hiroshiba-cho,Suita-city,Osaka 564-0052,Japan.

TEL:06-6386-8141 FAX:06-6386-8140

TOKYO BRANCH OFFICE : 67,Kandasakumagashi,Chiyoda-ku,Tokyo 101-0026,Japan.

TEL:03-5835-3311 FAX:03-5835-3316

NAGOYA OFFICE : 3-10-17,Uchiyama,Chikusa-ku,Nagoya-city,Aichi 464-0075,Japan.

TEL:052-731-5751 FAX:052-731-5780

KYUSHU OFFICE : 14-1,2-chome,Asano,Kokurakita-ku,Kitakyushu-city,Fukuoka 802-0001,Japan.

TEL:093-521-9830 FAX:093-521-9834