

JENCO®

QUALITY INSTRUMENTS

Operation Manual
MODEL 6011M/6011EU
Basis Portable
pH/ORP/Temperature Meter

6011M/6011EU

CONTENTS

| | |
|--|-----------|
| GENERAL INTRODUCTION..... | 2 |
| INITIAL INSPECTION..... | 2 |
| INSTALLING THE BATTERIES..... | 3 |
| CONNECTORS..... | 3 |
| DISPLAY & KEY FUNCTIONS..... | 4 |
| A. Display | 4 |
| B. Operational keys description..... | 6 |
| OPERATIONAL PROCEDURES..... | 7 |
| A. Buffer Set Selection..... | 7 |
| B. pH Calibration..... | 8 |
| C. pH Measurements..... | 12 |
| D. Temperature Measurements..... | 13 |
| E. mV Measurements..... | 13 |
| F. Save, Recall and Delete Data..... | 14 |
| G. pH Buffers..... | 16 |
| ERROR DISPLAYS AND TROUBLESHOOTING..... | 17 |
| SPECIFICATIONS..... | 18 |
| WARRANTY | 19 |

GENERAL INTRODUCTION

Thank you for selecting the 6011M/6011EU meter. The 6011M/6011EU is a precision tool that measure pH, ORP and temperature. A built-in microprocessor stores, calculates and compensates for all parameters related to pH determinations including pH electrode temperature characteristics, electrode slope deviations and buffer solutions.

This unit has a waterproof IP67 case. The touch mode keys are highly reliable with tactile and audio feedback. This meter can operate with one 9 V battery, typical battery life is 800 hours. Re-calibration is not required when power is turned on again.

The front of the meter has a large LCD that displays pH or ORP and temperature simultaneously along with user prompts and mode indicators. The unit prompts the user through calibration and measurement procedures.

An AUTOLOCK feature for both pH and ORP measurements enables the unit to automatically sense the end point and the “√” display indicates the end point value of a measurement. AUTOLOCK and user prompts help to eliminate most errors in determining pH and mV values, resulting in precise, repeatable and error-free measurements. The 6011M/6011EU can also be used in non-AUTOLOCK mode.

The unit is also equipped with a non-volatile memory allowing the user to store 50 different sets of readings. This unit will assign a site number for each set of reading so the user can review the data easily.

The model 6011M/6011EU is available with pH, ORP and ATC (Automatic Temperature Compensation) probes. Other features include electrode offset recognition, electrode slope recognition, electrode efficiency display, built-in buffer coefficients, automatic or manual temperature compensation, long battery life. This meter is user-friendly for field, industrial and laboratory applications.

[IMPORTANT NOTE: The 6011M has a 10 K Ω thermistor and the 6011EU has a 30 K Ω thermistor. There temperature sensor is not interchangeable.]

INITIAL INSPECTION

Carefully unpack the unit and accessories. Inspect for damages made in shipment. If any damage is found, notify your **Jenco** representative immediately. All packing materials should be saved until satisfactory operation is confirmed.

INSTALLING THE BATTERIES

The 6011M/6011EU meter is packaged with one 9 V battery required for operation. To insert the batteries into the meter, follow the procedure outlined below.

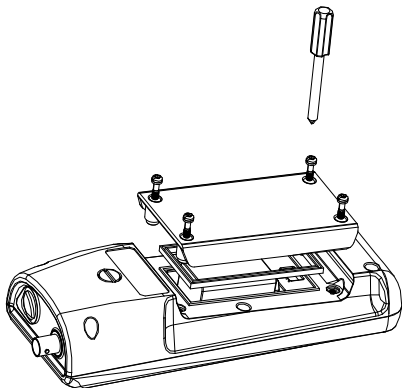

Figure 1: Battery compartment

1. Use a screw driver to remove the four screws and battery cover to expose the battery compartment. (Figure 1.)
2. Replace the 9 V battery.
3. Replace the battery cover and make sure to secure the four screws for the water-tight feature.

CONNECTORS

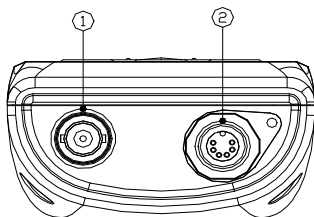

Figure 2: 6011M Connectors

1. pH/ORP connector (BNC connector)
2. ATC connector (6 PIN waterproof connector)

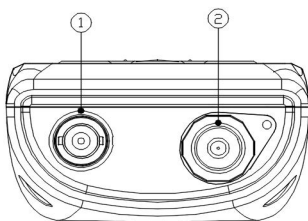

Figure 3: 6011EU Connectors

1. pH/ORP connector (BNC connector)
2. ATC connector (3.5 mm waterproof phone jack)

DISPLAY & KEY FUNCTIONS

A. Display

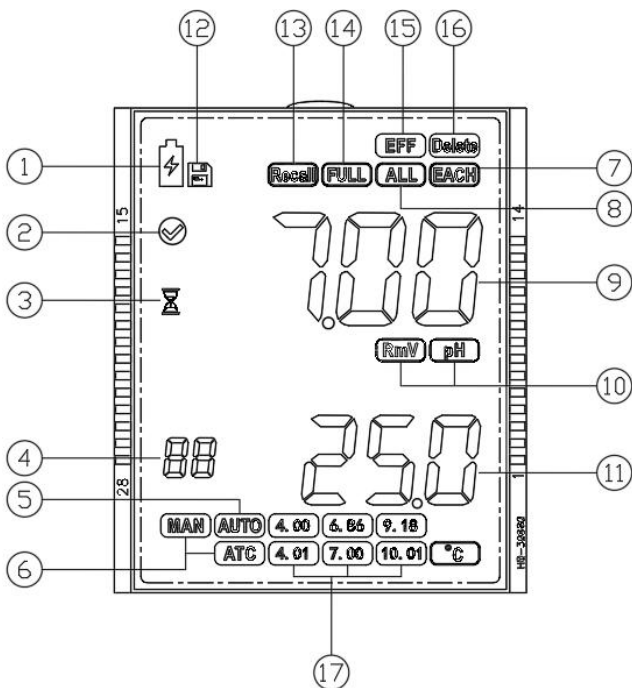

Figure 4: Active LCD screen

| | |
|---|--|
| <p>1. B- Low battery indicator.</p> | <p>2. √- This will indicate that the reading is frozen during AUTOLOCK mode.</p> |
| <p>3. ⌚- This will be displayed when the unit is still waiting for a stable reading or end point sensing.</p> | <p>4. Data storage site number.</p> |
| <p>5. AUTO- AUTOLOCK mode indicator.</p> | <p>6. ATC/MAN- ATC indicator will be displayed if a temperature probe is connected otherwise the MAN indicator will be displayed.</p> |
| <p>7. Each- To delete a single set of data from the data storage.</p> | <p>8. All- To delete all the data in the data storage.</p> |
| <p>9. Main display for pH, mV and probe efficiency values</p> | <p>10. pH/mV- Unit and mode indicators.</p> |
| <p>11. Temperature and unit display</p> | <p>12. Save- To save a reading into the data storage.</p> |
| <p>13. Recall- To recall data from the data storage.</p> | <p>14. Full- This will indicate that all 50 data storage sites are used up.</p> |
| <p>15. EFF- This will be displayed if the user is viewing the efficiency of the electrode.</p> | <p>16. Delete- To delete stored data.</p> |
| <p>17. Buffer selection- This indicator will flash if the unit is not yet calibrated. This indicator will remain lit-up if the unit has been calibrated.</p> | |

B. Operational keys description

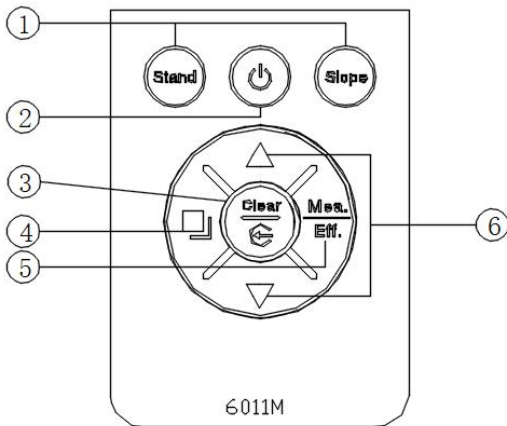









Figure 5

| NO. | Key | Description |
|-----|---|--|
| 1 |   | Stand & Slope- The “ Stand ” and “ Slope ” keys are used for pH calibration of the unit. Pressing and holding the “ Stand ” key while turning on the power, will change the buffer set to the other available buffer set. |
| 2 |  | On/Off- Powers on and shuts off the meter. |
| 3 |  | Clear/Enter- It is used to clear the unit when error signal appears. It clears all calibration values stored in the internal memory. In the pH measure mode, press and hold this key for 5 seconds, all LCD elements will lit up. The meter clears all calibration values stored in internal memory. In the measure mode, press this key to save reading into the next available data storage site. At the Recall interface, press this key to display the last set of saved data. At the Delete interface, press this key to go into “Delete” mode. In the “Delete All” mode, press this key to delete all saved data. |

| | | |
|---|--|---|
| | | In the “Delete Each” mode, press this key to delete a single set of data. |
| 4 |  | Mode- Selects display mode. Pressing this key changes the display sequentially to display pH-AUTOLOCK, mV-AUTOLOCK, pH, mV, Recall and Delete interface. In the “Recall” and “Delete” modes, press this key to exit “Recall” and “Delete” modes respectively. In the calibration mode, press “ Mode ” key to exit calibration mode. |
| 5 |  | Mea./Eff.- The key is used to bring the unit out of the AUTOLOCK condition when operating in the pH-AUTOLOCK or mV-AUTOLOCK mode. Press and hold this key for 5 seconds, the LCD will display the efficiency of the electrode and offset value. |
| 6 |  | Up & Down- The two keys are used to manually enter the temperature values. They have no effect on the unit when operating in ATC mode. In the “Recall” mode, view saved data and data storage site number by pressing these keys. In the “Delete” mode, press these keys to select between the “Delete Each” and “Delete All” mode. In the “Delete Each” mode, view to be deleted data and data site numbers by pressing these keys. |

OPERATIONAL PROCEDURES

A. pH Buffer Set Selection

The 6011M/6011EU meter has two buffer sets: 7.00, 4.01, 10.01 pH and 6.86, 4.00, 9.18 pH. The meter is factory pre-set at 7.00, 4.01 and 10.01 pH.

To change the buffer set, turn off the unit, then press and hold the “**Stand**” key while turning on the unit again.

[Note: There is no need to repeat this procedure every time the unit is power up unless one decides to change the buffer settings.]

B. pH Calibration

The 6011M/6011EU uses up to 3 point calibration.

[**Note:** If the device is required to perform more than one calibration points, the first calibration point must be 6.86/7.00 pH.]

a. **Calibration with an ATC/Temp probe in the pH-AUTOLOCK mode.**

1. Turn the unit on. In the pH mode, Press **“Clear/Enter”** key for 5 seconds, all LCD elements will lit up. The meter clears all calibration values stored in the internal memory.
2. Connect the pH electrode to the BNC connector and the ATC/Temp probe to the ATC/Temp connector of the unit.
3. Press **“Mode”** key to go to pH-AUTOLOCK mode. “ATC” icon, “pH” icon and “AUTO” icon will lit up. The “buffer” icon will flash.
4. Rinse the pH and ATC/Temp probes in distilled water and immerse them in the first buffer solution (either 7.00 or 6.86 pH). Allow temperature reading to stabilize, then press and hold **“Stand”** key for 2 seconds to calibrate. The “” icon will flash until the unit detects a stable reading. Once the unit calibrates the first point, the “4.00 (4.01)” and “9.18 (10.01)” icon will flash. The unit is ready to be sloped at the second buffer.

[**Note:** If the first buffer solution is 7.00 or 6.86 pH, at this moment, press the **“Mode”** key. The unit will exit the calibration mode. Single point calibration is complete.

If the first buffer solution is 4.00, 4.01, 9.18 , 10.01 pH, at this moment, the unit will automatically exit the calibration mode. Single point calibration is complete.]

5. Rinse the pH and ATC/Temp probe in distilled water and immerse them in the second buffer solution (either 4.00 / 4.01 pH or 9.18 / 10.01 pH corresponding to the flashing number on display). Allow temperature reading to stabilize, then press **“Slope”** key to calibrate. The “” icon will flash until the unit detects a stable reading. Once the unit calibrates the second point, the selected two buffers lit up and the remaining buffer starts to flash. The unit is ready to be sloped at the third buffer.

[**Note:** At this moment, press the **“Mode”** key, the unit will

exit the calibration mode. Dual point calibration is complete.]

6. Rinse the pH and ATC/Temp probe in distilled water and immerse them in the third buffer solution (either 4.00/4.01 pH or 9.18/10.01 pH corresponding to the flashing number on display). Allow temperature reading to stabilize, then press **“Slope”** key to calibrate. The “⌚” icon will flash until the unit detects a stable reading. Once the unit calibrates the third point and the unit will automatically exit the calibration mode. Three point calibration is complete.
7. The unit calculates and compensates for the pH electrode slope deviation corresponding to the values of the calibrated buffers. After calibration, press and hold **“Mea./Eff.”** key for about 5 seconds to display the new electrode efficiency and offset.

b. Calibration with manual temperature compensation in the pH-AUTOLOCK mode.

1. Turn the unit on. In the pH mode, Press **“Clear/Enter”** key for 5 seconds, all LCD elements will lit up. The meter clears all calibration values stored in internal memory.
2. Connect the pH electrode to the BNC connector of the unit.
3. Press **“Mode”** key to go to pH-AUTOLOCK mode. “MAN” icon, “pH” icon and “AUTO” icon will lit up. The “buffer” icon will flash.
4. Rinse the pH probes in distilled water and immerse it in the first buffer solution (either 7.00 or 6.86 pH). Adjust the temperature reading to that of the first buffer using the **“Up”** or **“Down”** keys (0.0 to 60.0 °C) before pressing **“Stand”** key. Then press and hold **“Stand”** key for 2 seconds to calibrate. The “⌚” icon will flash until the unit detects a stable reading. Once the unit calibrates the first point, the “4.00 (4.01)” and “9.18 (10.01)” icon will flash. The unit is ready to be sloped at the second buffer.

[**Note:** If the first buffer solution is 7.00 or 6.86 pH, at this moment, press the **“Mode”** key. The unit will exit the calibration mode. Single point calibration is complete.

If the first buffer solution is 4.00, 4.01, 9.18 , 10.01 pH, at this moment, the unit will automatically exit the calibration mode. Single point calibration is complete.]

5. Repeat steps 5 to 6 of **“Calibration with an ATC/Temp probe**

in the pH-AUTOLOCK mode” for dual and three point calibration.

6. The unit calculates and compensates for the pH electrode slope deviation corresponding to the values of the two calibration buffers. After calibration, press and hold **“Mea./Eff.”** key for 5 seconds to display the new electrode efficiency and offset.

c. Calibration with an ATC/Temp probe in the pH NON-AUTOLOCK mode.

1. Turn the unit on. In the pH mode, Press **“Clear/Enter”** key for 5 seconds, all LCD elements will lit up. The meter clears all calibration values stored in internal memory.
2. Connect the pH electrode to the BNC connector and the ATC/Temp probe to the ATC/Temp connector of the unit.
3. Press **“Mode”** key for the LCD to display pH and the AUTOLOCK annunciator is off. “ATC” icon will lit up. “pH” icon is on. The “buffer” icon will flash.
4. Rinse the pH and ATC/Temp probes in distilled water and immerse them in the first buffer solution (either 7.00 or 6.86 pH). Allow temperature reading to stabilize, then press and hold **“Stand”** key for 2 seconds to calibrate. Once the unit calibrates the first point, the “4.00 (4.01)” and “9.18 (10.01)” icon will flash. The unit is ready to be sloped at the second buffer.

[Note: If the first buffer solution is 7.00 or 6.86 pH, at this moment, press the **“Mode”** key. The unit will exit the calibration mode. Single point calibration is complete. If the first buffer solution is 4.00, 4.01, 9.18 , 10.01 pH, at this moment, the unit will automatically exit the calibration mode. Single point calibration is complete.]

5. Rinse the pH and ATC/Temp probe in distilled water and immerse them in the second buffer solution (either 4.00/4.01 or 9.18/10.01 pH). Allow temperature reading to stabilize, then press **“Slope”** key to calibrate. Once the unit calibrates the second point, the selected two buffers lit up and the remaining buffer starts to flash. The unit is ready to be sloped at the third buffer.

[Note: At this moment, press the **“Mode”** key, the unit will exit the calibration mode. Dual point calibration is complete.]

6. Rinse the pH and ATC/Temp probe in distilled water and immerse them in the third buffer solution (either 4.00/4.01 pH or 9.18/10.01 pH corresponding to the flashing number on display). Allow temperature reading to stabilize, then press **“Slope”** key to calibrate. Once the unit calibrates the third point and the unit will automatically exit the calibration mode. Three point calibration is complete.
7. The unit calculates and compensates for the pH electrode slope deviation corresponding to the values of the calibrated buffers. After calibration, press and hold **“Mea./Eff.”** key for about 5 seconds to display the new electrode efficiency and offset.

d. Calibration with manual temperature compensation in the pH NON-AUTOLOCK mode.

1. Turn the unit on. In the pH mode, Press **“Clear/Enter”** key for 5 seconds, all LCD elements will lit up. The meter clears all calibration values stored in internal memory.
2. Connect the pH electrode to the BNC connector of the unit.
3. Press **“Mode”** key for the LCD to display pH and the AUTOLOCK annunciator is off. **“MAN”** icon will lit up. **“pH”** icon is on. The **“buffer”** icon will flash.
4. Rinse the pH probes in distilled water and immerse it in the first buffer solution (either 7.00 or 6.86 pH). Adjust the temperature reading to that of the first buffer using the **“Up”** or **“Down”** keys (0.0 to 60.0 °C) .Then press and hold **“Stand”** key for 2 seconds to calibrate. The unit immediately calibrates the first point, the selected buffer remains lit up while the remaining buffers start to flash. The unit is ready to be sloped at the second buffer.

[Note: If the first buffer solution is 7.00 or 6.86 pH, at this moment, press the **“Mode”** key. The unit will exit the calibration mode. Single point calibration is complete. If the first buffer solution is 4.00, 4.01, 9.18 , 10.01 pH, at this moment, the unit will automatically exit the calibration mode. Single point calibration is complete.]

5. Repeat steps 5 to 6 of **“Calibration with an ATC/Temp probe in the pH NON- AUTOLOCK mode”** for dual and three point calibration.
6. The unit calculates and compensates for the pH electrode slope deviation corresponding to the values of the calibrated

buffers. After calibration, press and hold “**Mea./Eff.**” key for about 5 seconds to display the new electrode efficiency and offset.

C. pH Measurements

To take pH measurements, 6011M/6011EU must be calibrated before first use.

a. **Measurement with an ATC/Temp probe in the pH-AUTOLOCK mode.**

1. Connect the pH electrode to the BNC connector and the ATC/Temp probe to the ATC/Temp connector of the unit. The “ATC” icon will lit up.
2. Press “**Mode**” key until “pH”, “AUTO”, “ATC”, “buffer” “⌚” icons lit up.
3. Rinse the pH electrode and ATC/temp probe with distilled water and immerse them in the sample to be measured. Remove any air bubbles trapped around the probe by shaking or stirring the probe.
4. Press the “**Mea./Eff.**” key. The “⌚” icon will start flashing. The unit is waiting for a stable reading. The display will track the pH value as sensed by the pH electrode and the ATC/Temp probe.
5. When the “⌚” icon disappears and the “√” icon appears, the meter will not respond to further changes from the sample. The pH value shown is the pH value of the sample at the displayed sample temperature.

[**Note:** For samples that are inherently unstable, the unit will not AUTOLOCK. In this case, use the pH NON- AUTOLOCK mode for measurements.]

b. **Measurement with manual temperature compensation in the pH-AUTOLOCK mode.**

1. Connect the pH electrode to the BNC connector of the unit. The “MAN” icon will lit up. Set unit to display the sample temperature by pressing the “**Up**” and “**Down**” keys (-10.0 to 120.0 °C).
2. Press “**Mode**” key until “pH”, “AUTO”, “MAN”, “buffer” “⌚” icons lit up.

3. Repeat steps 3 to 5 of **“Measurement with an ATC/Temp probe in the pH- AUTOLOCK mode”**.
- c. Measurement with an ATC/Temp probe in the pH NON-AUTOLOCK mode.**
1. Connect the pH electrode to the BNC connector and the ATC/Temp probe to the ATC/Temp connector of the unit. The “ATC” icon will lit up.
 2. Press **“Mode”** key until the “pH”, “ATC” and “buffer” icons lit up.
 3. Rinse the pH electrode and ATC/temp probe with distilled water and immerse them in the sample to be measured. Remove any air bubbles trapped around the probe by shaking or stirring the probe.
 4. Allow sufficient time for the display to stabilize. The instrument will display the pH value of the sample at the displayed sample temperature.
- d. Measurement with manual temperature compensation in the pH NON-AUTOLOCK mode.**
1. Connect the pH electrode to the BNC connector of the unit. The “MAN” icon will lit up. Set unit to display the sample temperature by pressing the **“Up”** and **“Down”** keys (-10.0 to 120.0 °C).
 2. Press **“Mode”** key until the “pH”, “MAN” and “buffer” icons lit up.
 3. Repeat steps 3 to 4 of **“Measurement with an ATC/Temp probe in the pH NON- AUTOLOCK mode”**.

D. Temperature Measurements

The 6011M/6011EU can measure temperature independently with the ATC/temp probe without using the pH electrode. Place the ATC/temp probe in the sample. The unit will display the measured temperature.

E. mV Measurements

a. Measurement in the mV-AUTOLOCK mode.

1. Connect the combination ORP electrode to the BNC connector of the unit.

2. Press “**Mode**” key until the “mV”, “AUTO”, “MAN” and “⌚” icons lit up.
3. Rinse the electrode with distilled water and immerse them in the sample to be measured. Remove any air bubbles trapped around the probe by shaking or stirring the probe.
4. Press the “**Mea./Eff.**” key. The “⌚” icon will start flashing. The unit is waiting for a stable reading. The meter will track the mV value as sensed by the ORP electrode.
5. When the “⌚” icon disappears and the “√” icon appears, the meter will not respond to further changes from the sample. The mV value is the sample reading.

[Note: For samples that are inherently unstable, the unit will not AUTOLOCK. In this case, use the mV NON- AUTOLOCK mode for measurements.]

b. Measurement in the mV NON-AUTOLOCK mode.

1. Connect the combination ORP electrode to the BNC connector of the unit.
2. Press “**Mode**” key until the “mV” and “MAN” icons lit up.
3. Rinse the electrode with distilled water and immerse them in the sample to be measured. Remove any air bubbles trapped around the probe by shaking or stirring the probe.
4. Allow sufficient time for the display to stabilize. The instrument will display the mV value of the sample.

F. Save, Recall and Delete Data

a. Saving readings to memory.

1. In the measure modes, press the “**Clear/Enter**” key to save data. The “Save” icon with the corresponding site number will lit up for a brief moment to indicate a successful data save. Saving is now complete.
2. If the “Full” icon is displayed, this means that all 50 data saving sites are used up. No new data can be saved until existing saved data are deleted.

b. Recalling readings from memory.

1. To recall saved data, Press “**Mode**” key until the “Recall” icon

lit up. Press "**Clear/Enter**" key to go into "Recall" mode.

2. Press the "**Up**" or "**Down**" keys to select the storage site number.
3. Press "**Mode**" key to exit "Recall" mode.

c. Deleting data.

1. Press "**Mode**" key until the "Delete" icon lit up. Press "**Clear/Enter**" key to go into "Delete" mode.
2. Select "Delete All" or "Delete Each" mode by pressing the "**Up**" or "**Down**" key.
3. In the "Delete all" mode, press "**Clear/Enter**" key to clear all stored data. Deletion is now complete.
4. In the "Delete Each" mode, use "**Up**" and "**Down**" key to select data to be deleted. Then press "**Clear/Enter**" key to delete. Deletion is now complete. The next set of saved data will automatically move up a slot in the storage site.
5. Press "**Mode**" key to exit "Delete" mode.

G. pH Buffers

The temperature coefficient of pH calibration buffers 4.00, 4.01, 6.86, 7.00, 9.18 and 10.01 pH are stored inside the instrument. The buffers used to calibrate the instrument must exhibit the same temperature characteristics as the stored values.

Temperature coefficient of the pH buffers

| | | | | | | |
|----|------|------|------|------|------|-------|
| °C | 4.00 | 6.86 | 9.18 | 4.01 | 7.00 | 10.01 |
| 0 | 4.01 | 6.98 | 9.46 | 4.01 | 7.11 | 10.32 |
| 5 | 4.00 | 6.95 | 9.39 | 4.01 | 7.08 | 10.25 |
| 10 | 4.00 | 6.92 | 9.33 | 4.00 | 7.06 | 10.18 |
| 15 | 4.00 | 6.90 | 9.28 | 4.00 | 7.03 | 10.12 |
| 20 | 4.00 | 6.88 | 9.23 | 4.00 | 7.01 | 10.06 |
| 25 | 4.00 | 6.86 | 9.18 | 4.01 | 7.00 | 10.01 |
| 30 | 4.01 | 6.85 | 9.14 | 4.01 | 6.98 | 9.97 |
| 35 | 4.02 | 6.84 | 9.10 | 4.02 | 6.98 | 9.93 |
| 40 | 4.03 | 6.84 | 9.07 | 4.03 | 6.97 | 9.89 |
| 45 | 4.04 | 6.83 | 9.04 | 4.04 | 6.97 | 9.86 |
| 50 | 4.06 | 6.83 | 9.02 | 4.06 | 6.97 | 9.83 |
| 55 | 4.07 | 6.83 | 8.99 | 4.08 | 6.97 | 9.80 |
| 60 | 4.09 | 6.84 | 8.97 | 4.10 | 6.98 | 9.78 |

[Note: The actual reading of the instrument can differ from the values shown by $\pm 0.01\text{pH}$.]

ERROR DISPLAYS AND TROUBLESHOOTING

| Main Display | Possible Cause(s) | Corrective Action(s) |
|--------------------|--|--|
| "Er1" | <ol style="list-style-type: none"> 1. "Stand" was pressed before the electrode and ATC/Temp probe settled to within +/-1.5 pH of the buffer value. 2. pH electrode offset is greater / less than +/-1.5 pH. 3. pH electrode is faulty. | <ol style="list-style-type: none"> 1. Press "Clear/Enter" key, allow sufficient time for the electrode and ATC/Temp probe to stabilize, re-press "Stand" key to start the calibration procedure. 2. Replace the buffer and /or the pH electrode. Press "Clear/Enter" key to recalibrate meter. 3. Replace electrode. |
| "Er2" | <ol style="list-style-type: none"> 1. "Slope" was pressed before the electrode and ATC/Temp probe settled to within 30% of the buffer value. 2. Buffer 4.00, 4.01, 9.18 and 10.01 pH is not correct. 3. pH electrode slope is off by more than 30% of ideal slope. | <ol style="list-style-type: none"> 1. Allow sufficient time for the electrode and ATC/Temp probe to stabilize, re-press "Slope" key to continue the calibration procedure. 2. Check if the correct buffer is used. 3. Replace the buffer and /or the pH electrode. Press "Clear/Enter" key to recalibrate meter. |
| "Er3" | <ol style="list-style-type: none"> 1. Temperature is out of the 0.0 to 60.0°C range. | <ol style="list-style-type: none"> 1. Bring the buffer temperature within range. |
| "over" / "undr" | <ol style="list-style-type: none"> 1. Measured pH is out of the -2.00 to 16.00 pH range. 2. Measured mV is out of the -1999 to 1999 mV range. 3. Measured temperature is out of the -10.0 to 120.0 °C range. | <ol style="list-style-type: none"> 1. Bring sample pH into the correct measuring range. 2. Bring sample ORP into the correct measuring range. 3. Bring sample temperature into the correct measuring range. |

[Note: If the meter still does not perform normally after the above measures are taken, call Jenco Service Department.]

SPECIFICATIONS

| Display | Range | Resolution | Accuracy |
|-------------|-------------------|------------|------------|
| pH | -2.00 to 16.00 pH | 0.01 pH | ±0.01 pH |
| ORP | -1999 to 1999 mV | 1 mV | ±0.1% F.S. |
| Temperature | -10.0 to 120.0 °C | 0.1 °C | ±0.3 °C |

| | |
|--|---|
| pH buffer recognition | 7.00, 4.01, 10.01 pH or 6.86, 4.00, 9.18 pH |
| pH Temperature compensation | AUTO/MAN -10.0 °C to 120.0 °C |
| pH Calibration | Up to 3 points |
| pH Buffer Temperature range | 0 to 60.0 °C |
| pH Electrode Offset recognition | ±90 mV at 7.00 or 6.86 pH |
| pH Electrode SLOPE recognition | ±30% at 4.00, 4.01, 9.18 and 10.01 pH |
| Input impedance | >10 ¹² Ω |
| Temperature sensor | Thermistor, 10 kΩ at 25°C (6011M) Thermistor, 30 kΩ at 25°C (6011EU) |
| Calibration Back-up | EEPROM |
| Datalogging capabilities | 50 data sets |
| Automatic shut off function | 10 minutes of non-use |
| Audio Feedback | All touch keys |
| End Point Sensing & Hold | Yes |
| Screen | Segmented LCD |
| Power | 9 Volt battery |
| Battery Life | 800 Hours |
| Ambient Temperature Range | 0 to 50 °C |
| Relative Humidity | At 90% RH |
| Waterproof | IP67 |
| Dimensions | 214 X 74 X 42 mm 216 X 80 X 50 mm (Have jacket) |
| Weight | 290 g |

WARRANTY

Jenco warrants this product to be free from significant deviations in material and workmanship for a period of 1 year from date of purchase. If repair or adjustment is necessary and has not been the result of abuse or misuse, within the year period, please return-freight-prepaid and the correction of the defect will be made free of charge. If you purchased the item from our **Jenco** distributors and it is under warranty, please contact them to notify us of the situation. **Jenco** Service Department alone will determine if the product problem is due to deviations or customer misuse.

Out-of-warranty products will be repaired on a charge basis.

RETURN OF ITEMS

Authorization must be obtained from one of our representatives before returning items for any reason. When applying for authorization, have the model and serial number handy, including data regarding the reason for return. For your protection, items must be carefully packed to prevent damage in shipment and insured against possible damage or loss. **Jenco** will not be responsible for damage resulting from careless or insufficient packing. A fee will be charged on all authorized returns.

NOTE: Jenco reserves the right to make improvements in design, construction and appearance of our products without notice.

Jenco Instruments, Inc.

7968 Arjons Drive, Suite C
San Diego, CA 92126 USA

TEL: 858-578-2828

FAX: 858-578-2886

E-Mail: jencoinfo@jencoi.com; sales@jencoi.com

Website: www.jencoi.com

Jenco Electronics, Ltd.

6F., NO. 81, Sec.2, Chang-an E. Rd., Jhongshan District, Taipei
City 104, Taiwan

TEL: 886-2-2508-2928

FAX: 886-2-2508-2938

E-Mail: sales@jenco.com.tw

Website: www.jenco.com.tw

Shanghai Jenco Instruments, Ltd.

18 Wang Dong Zhong Road

Sijing Town, Songjiang

Shanghai, China

TEL: 86-021-5761-9599

FAX: 86-021-5761-9598

E-Mail: jencos@jenco.com.cn

Website: www.jenco.com.cn