

I N S T R U C T I O N M A N U A L
F O R
M O N I T O R U N I T

M O D E L : M P 2 0 0 0



Revision △ Apr. 09, 2003
Issued Dec. 24, 2002



NOHKEN INC.

MUST BE READ BEFORE USING

- This manual is for standard specifications. Read the other manuals for explosion-proof specifications.
- This manual describes the handling, inspection and adjustment of the monitor unit. Read and understand this manual before installation.
- Any documents and/or directions from Nohken and the agents aside from this manual shall be preceded.
- Save this manual to refer when you need.
- If you have any questions or comments about this manual and/or the unit, ask Nohken's sales office.

Signal words in this manual means as follows:

 CAUTION	Indicates an potentially hazardous situation which, if not avoided, may result in minor or moderate injury.
 NOTE	Indicates exceptional cases and attention for handling of units.

	Indicates prohibition. The explanation with this manual should always be followed.
	Indicates directions. The explanation with this manual should always be followed.

▲ CAUTIONS

- Since this unit is not an explosion-proof construction, do not use where flammable gas, explosive gas or the vapor exists. Otherwise, explosion the gases and/or the vapor may cause serious disasters. Use explosion-proof unit at hazard areas.



- Do not modify or disassemble the unit. Otherwise, the monitor unit may be damaged.



- Turn off the power before wiring, maintenance or inspection. Otherwise, the electric leakage, electric shock and ignited by short circuit may be occurred.



- Make sure that there is no miswiring. Otherwise, the sensor may cause damage, ignition and electric shock .



- Turn off the power supply immediately when abnormal conditions are encountered, such as smoke, disagreeable smell and unusual noise.



▲ NOTES

- Do not give strong shocks to the monitor unit. Dropping, throwing, striking and dragging the sensor, for example, are to cause strong shocks and damage the unit.



- The specifications such as ambient temperature, maximum voltage and the power rating shall meet the conditions. Otherwise, the unit may cause malfunction, damage, ignition, electric shock and injury. Read and check the clause of specification in the manual or specification sheets.



⚠ NOTES

- Operating test shall be conducted before practical use. If malfunction occurs and the accident is predicted, the remedy shall be administrated by using another unit in parallel.



- To prevent from electric shocks such as lightning and the static electricity, provide conductor or the surge absorber. Otherwise, the unit may cause malfunction, damage, ignition, electric shock and injury.



- When connecting inductive load or the lamp load to the relay output contact.
To prevent overvoltage and overcurrent, provide a protective circuit to the load. Otherwise, the contact may be damaged.



INTRODUCTION

- A. This manual specifies standard specifications of this product. Some specifications may be different from your product if you order the custom-made product.
- B. A variety of specifications are available to meet your process conditions, such as installation conditions, chemical compatibility, and so on. We are glad to offer suggestions to assist your decision.
- C. If you have any questions or comments for the contents of this manual, ask Nohken's sales office.
- D. Nohken Inc. pursues a policy of continuing improvement in design and performance of this product. We will supply the alternative parts or complete new products required to repair or replacement.
- E. Specifications are subject to change without any obligation on the part of the manufacturer.

WARRANTY & DISCLAIMER

- A. Nohken Inc. warrants this product against defects in design, material and workmanship for a period of 1 (one) year from the date of original factory shipment.
- B. If defects occurs during the above-mentioned warranty period, Nohken will, at its option, replace or recondition the product without charge. This shall constitute the exclusive remedy for breach of warranty.
- C. Nohken Inc. makes no warranty with respect to:
 - C-a Failure not to comply with instructions of this manual.
 - C-b Failure or damage due to improper installation, wiring, operation, maintenance, inspection and storing.
 - C-c Product which has been in any way repaired, altered or tampered with by others.
 - C-d Product repaired or modified by using undesignated parts, subassemblies and materials.
 - C-e Direct incidental or consequential damages or losses or expenses resulting from any defective product or the use of any product.
 - C-f Objective of the sensor is clearly specified in chapter 1, PURPOSE OF USE.
 - C-g Inevitable accident such as acts of God, force majeure, radioactive contamination and so on.

THIS WARRANTY IS IN LIEU OF AND EXCLUDES ALL OTHER WARRANTIES OF MERCHANTABILITY OR FITNESS FOR A PARTICULAR PURPOSE.

TABLE OF CONTENTS

	PAGE
1. PURPOSE OF USE	1
2. INTRODUCTION	1
3. FEATURES	1
4. SPECIFICATIONS	1
4.1 MODEL	1
4.2 SPECIFICATIONS	2
5. HANDLING CAUTIONS	3
6. MOUNTING	4
6.1 UNPACKING	4
6.2 INSTALLATION	4
6.2.1 CHECK OF ATTACHMENT PLACE	4
6.2.2 INSTALLATION	5
7. WIRING	6
7.1 PREPARATION	6
7.2 WIRING	6
7.3 OPERATIONAL CHECK	8
8. NOMENCLATURE	9
9. OPERATION	10
9.1 OPERATION	10
9.2 SETTING OF MONITOR UNIT	12
9.2.1 ZERO AND SPAN POINT ADJUSTMENT	12
9.2.2 ALARM OUTPUT SETTING	14
9.3 CONTENTS OF PARAMETER	16
9.3.1 INPUT AND OUTPUT	16
9.3.2 ALARM OUTPUT OPERATION	21
9.3.3 VOLUME CONVERSION	26
9.3.4 LINEAR PROFILE	29
9.3.5 CHECK TEST OF OPERATION	32
9.3.6 INITIALIZATION	32
9.4 ERROR MESSAGE	33
9.5 PARAMETER LIST	34
10. MAINTENANCE	35
11. STORAGE	36
12. TROUBLESHOOTING	36

1. PURPOSE OF USE

Monitor Unit model MP2000 is designed for use in indication, alarm outputs, and control for pump and similar devices by utilizing with our level sensors.

2. INTRODUCTION

Monitor Unit model MP2000 is a microprocessor-based (MPU) and compact. It provides easy calibration, volume conversion, linearization, and analog output (4-20mA DC) and relay outputs.

3. FEATURES

- (1) Available wide power supply, 100 to 240 V AC.
- (2) Programmable relay outputs for alarm orientation (High and Low), hysteresis, and fail-safe function.
- (3) EEPROM stores all parameter value permanently.
- (4) Volume conversion for volumetric indications.
- (5) Easy-to-read graphic indication and 4-digit LED.
- (6) Built-in test circuit for signal (4-20mA DC).
- (7) Power supply, inputs and outputs are isolated.

4. SPECIFICATIONS

4.1 MODEL

MP 2 0 0 0 - □

Code	Input Signal
0	Current signal (4 ~ 20 mA DC)
1	Current signal with 24V DC power supply (4 ~ 20 mA DC) (Rated current: 200 mA DC Max.)
2	Resistance signal with regular current signal 6 k Ω Max. (Rated current: 0.58 mA DC) More than 6 k Ω and 12 k Ω Max. (Rated current: 0.29 mA DC) More than 12 k Ω and 22 k Ω Max. (Rated current: 0.14 mA DC)

4.2 SPECIFICATIONS

Model			MP 2 0 0 0
Operation characteristics	Accuracy ^{*1}	Input / Output	Max. ± 0.5 % F.S.
		Display	Max. ± 0.3 % F.S. ± 1 digit
	Digits		-999 ~ 9999
	Sampling cycle		Approximately 0.3 seconds
Electrical characteristics	Power supply		100 ~ 240 V AC, 50/60 Hz ± 10 % (Allowable resistive load)
	Power consumption		20 VA Max.
	Power supply for sensor		Refer to 「4.1 MODEL」
	Input signal		Refer to 「4.1 MODEL」
	Output signal		4 ~ 20 mA DC
	Allowable resistive load		600 Ω Max.
	Alarm	Number of contact	4 alarm points (2 points \times 2 circuits) transfer (common use between HH and H, LL and L)
		Contact rating	240 V 3 A AC (with resistive load) 30 V 3 A DC (with resistive load)
	Withstand voltage test		1500 V AC for 1 minute (between power supply terminal and input terminal) 500 V AC for 1 minute (between output terminal and input terminal)
	Insulation resistance test		More than 100 M Ω at 500 V DC Megger (between power supply terminal to grand terminal) More than 50 M Ω at 250 V DC Megger (between output terminal and input terminal)
Environment	Working temperature		-5 ~ +50 $^{\circ}$ C
	Working humidity		85 % RH Max. (No condensing)
Physical	Material	body	A B S
		front panel	P E T
		fittings	A B S
		mounting screws	S U S
	Dimension		(H \times W \times D): 96 mm \times 96 mm \times 132 mm Except of fittings (Depth of the panel is 120 mm)
	Mass		520 g (except of fittings)
Mounting		Panel mount Cut out: in conjunction with DIN 43 700 - 96 \times 96 (panel cut-out: 92 \times 92 mm)	

*1: Accuracy shows current (4-20 mA DC) for MP2000-0 and -1,
and resistance (0-6 k Ω , 0-12k Ω , or 0-22k Ω) for MP2000-2.

5. HANDLING CAUTIONS

Following shall be observed when handling the MP. Otherwise, malfunction or accident may occur.

- Avoid physical shock. Dropping, throwing or bumping will damage the MP.

- Do not put the Monitor Unit where it will be exposed to direct sunlight. Locate away from condensation, dust and foreign matters.

- Do not put the Monitor Unit in puddles to avoid insulation failure.

- Do not use in a corrosive atmosphere such as NH_3 , SO_2 , Cl_2 , etc. Internal circuit board will be corroded through radiation slots.

- Keep the Monitor Unit in sealed plastic bags with desiccant or other moisture proof packing. Put it indoor when storing.

- Operational test should be performed to avoid malfunction when it is not used over one year.

- To avoid personal injury, JIS Class D grounding (less than 100 ohm) should be done.

- Key switches on the front panel are cushion switches. Push them surely.

- Do not push the front panel with sharp objects.

- Wipe the front panel clean of dirt with a clean dry cloth. Do not use solvents.

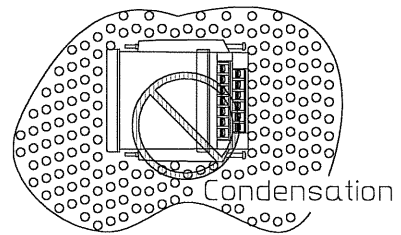
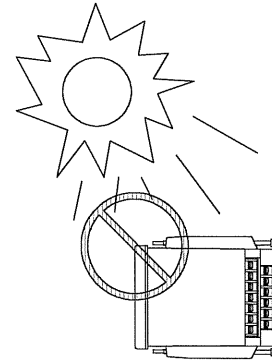
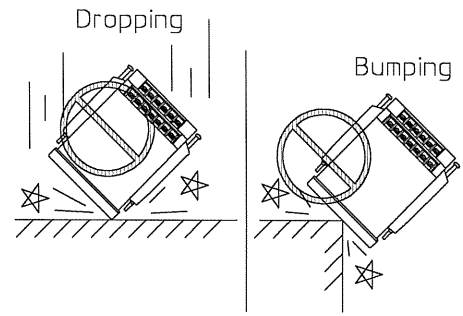

Corrosive atmosphere

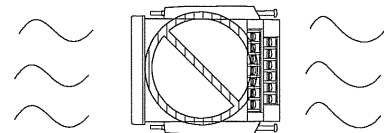

Moisture proof

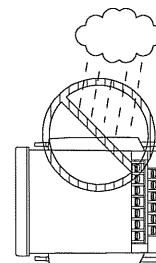

6.MOUNTING

6.1 UNPACKING



CAUTIONS

Since this Monitor Unit is not an explosion-proof construction, do not use where flammable gas, explosive gas or the vapor exists.



- (1) Avoid physical shock. Dropping, throwing or bumping will damage the MP.
- (2) Do not put things on the Monitor Unit. It will deform and damage the product.
- (3) Inspect the model numbering on the name plate to meet your order. If incorrect, ask to our sales department or our distributor.
- (4) After unpacking, inspect the MP for shipping damage. If there is evidence of damage, notify the carrier and us immediately.

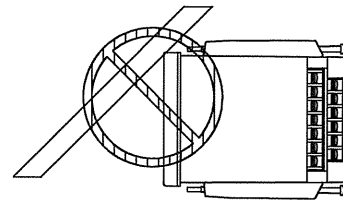
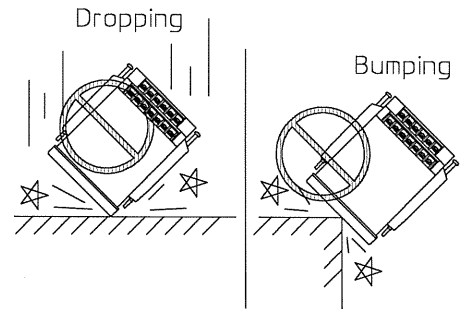

6.2 INSTALLATION

6.2.1 Check of attachment place

Provide ample space for maintenance and inspection.
Make sure the following to avoid malfunction.

- (1) Ambient temperature range is from $-5\text{ }^{\circ}\text{C}$ to $+50\text{ }^{\circ}\text{C}$, and humidity is under 85% RH.
- (2) The weight of the MP is 520 g. Provide Appropriate reinforce for thin panels if necessary.
- (3) Locate away from rain and jetting water. MP is not waterproof.

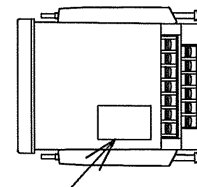

Name plate

6.2.2 INSTALLATION

- (1) Drill the mounting panel to mount the Monitor Unit. See the following figure for dimensions and mounting pitches.
- (2) Insert the MP from the front panel.
- (3) Install mounting brackets into the body of the MP from the back side of the mounting panel. See the following figure for mounting procedures.
- (4) Tighten mounting brackets with the Philips (+) driver surely.

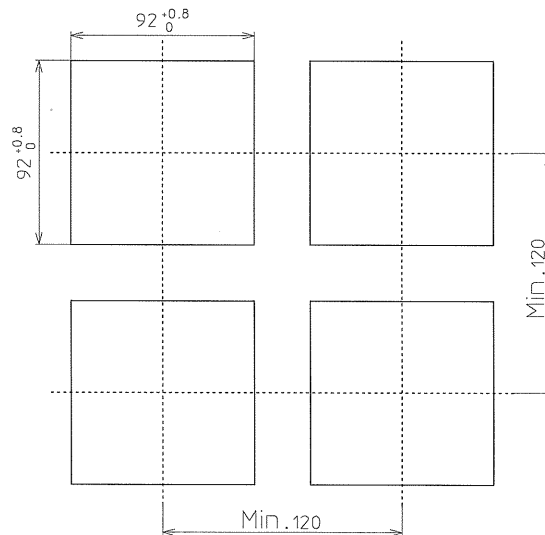

Panel cut dimension

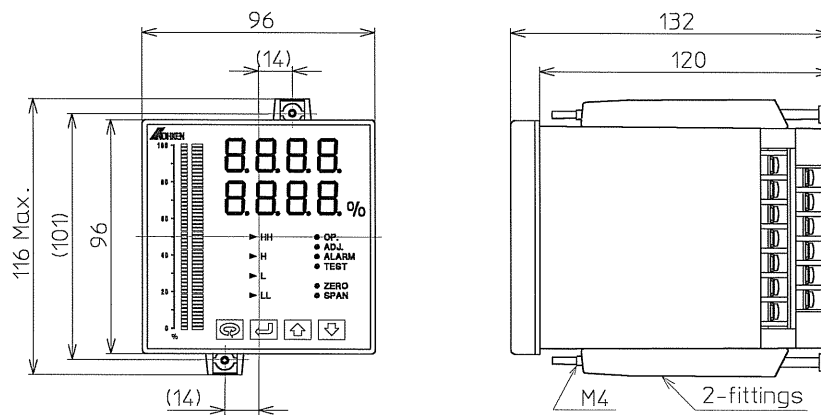

Dimensions of MP

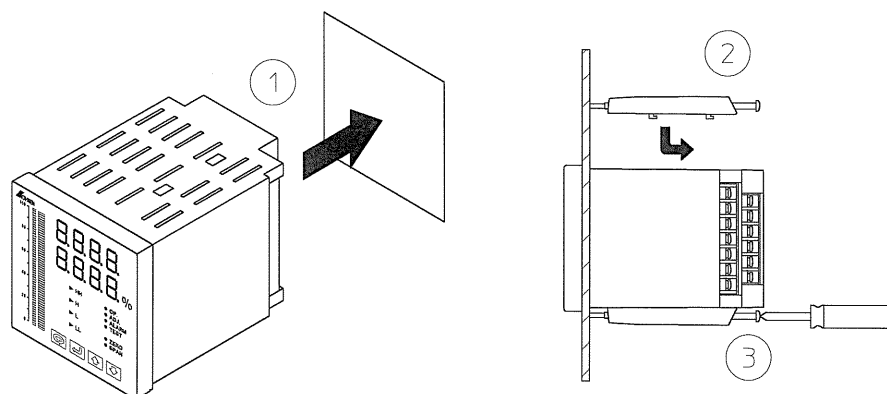

Procedures

7. WIRING

7.1 PREPARATION

Turn off the power supply during wiring.









CAUTIONS

- Turn off the power before wiring, maintenance or inspection. Otherwise, the electric leakage, electric shock and ignited by short circuit may be occurred.



7.2 WIRING

CAUTIONS

- | | |
|---|---|
| <ul style="list-style-type: none">• To avoid personal injury, JIS Class D grounding (less than 100 ohm) should be done. |  |
| <ul style="list-style-type: none">• Lay the analog output cable away from the power line to prevent noise. Should be done. |  |
| <ul style="list-style-type: none">• The shielded cable for both input and output line shall be one-point grounded. Two-point grounding may cause malfunction. |  |
| <ul style="list-style-type: none">• Make sure that the supply voltage is sufficient, within 100 to 240 V AC range. Otherwise, the MP may cause malfunction or damage. |  |
| <ul style="list-style-type: none">• Output load (resistive) is 600 ohm maximum. Excessive load cause malfunction. |  |
| <ul style="list-style-type: none">• Contact rating for relay output is 240 V 3 A AC or 30 V 3A DC. Provide external relays when exceeding. |  |
| <ul style="list-style-type: none">• When electrical surges are produced, provide appropriate surge absorber or protective circuit. |  |
| <ul style="list-style-type: none">• Reinstall the protective cover which is placed over the terminal plate to avoid electric shock. |  |

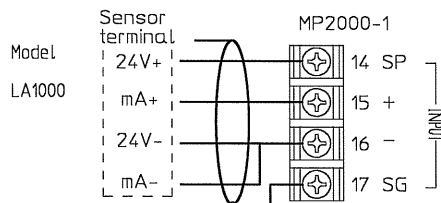
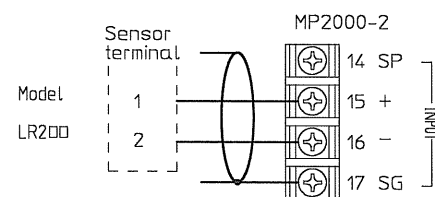
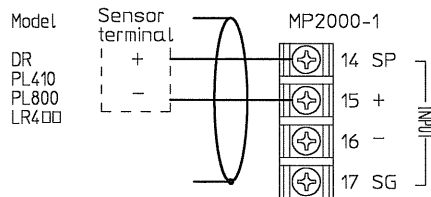
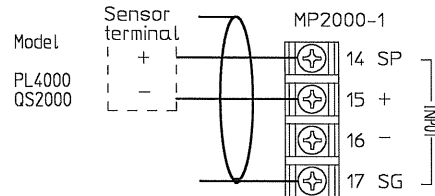
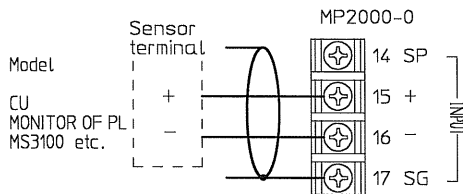
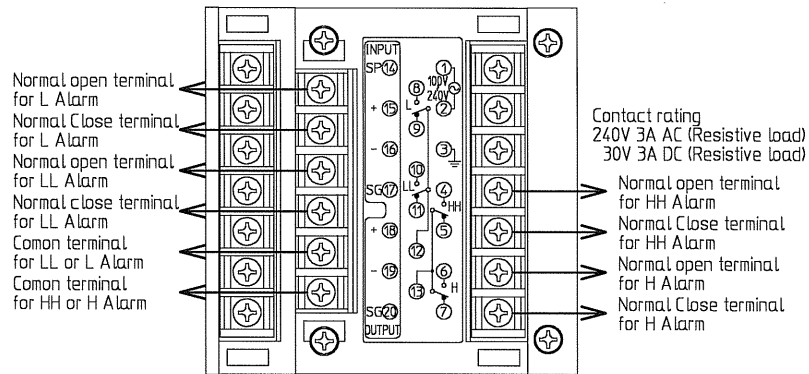
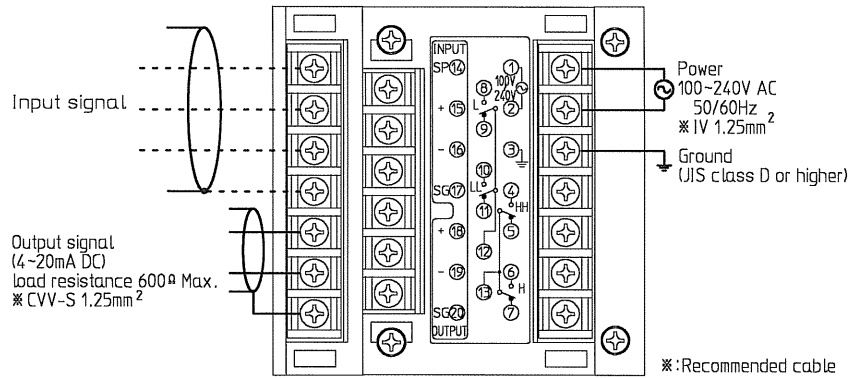

WIRING FOR INPUT SIGNAL



Fail-safe mode is programmable for alarm outputs.

Relay operations are completely changed when you choose the fail-safe mode.

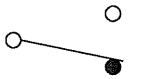
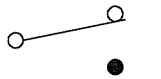
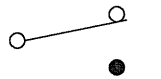
The default is without fail-safe mode. See the below table for operating differences.

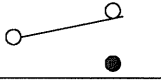
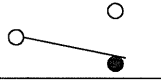
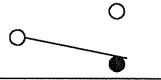
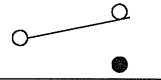
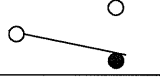
Power	Liquid level	Fail-safe mode		Without fail-safe mode	
		Operation		Operation	
		Up ON	Down On	Up ON	Down On
○ N	Set point or higher				
○ N	Set point or lower				
○ F F	—				

Wiring shall be in accordance with all local codes.

Since the terminal screw is M 3.5, we recommend to use shielded control cable of 1.25mm² with R1.25-3.5 (JIS C 2805) solderless rugs.

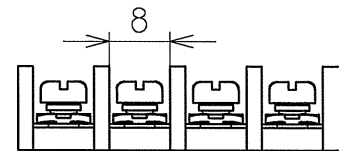

Terminal

Reinstall the protective cover which is placed over the terminal plate.

7.3 OPERATIONAL CHECK

Ensure the MP operation in the test stage. If the operation is unsuccessful, check wiring, read this manual again, or contact our sales department.

8. NOMENCLATURE

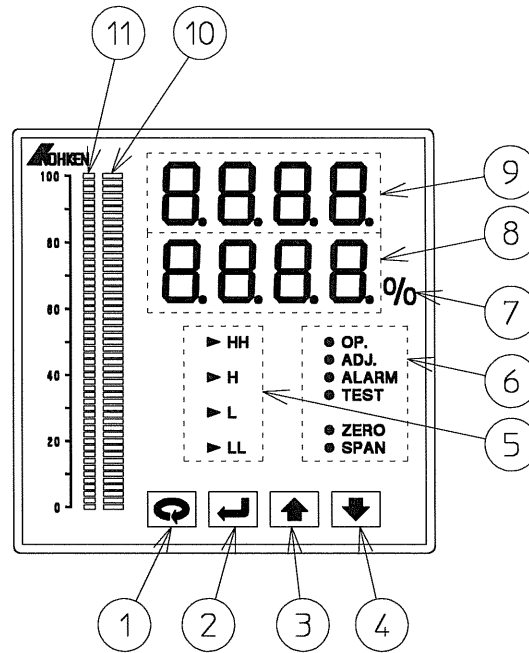

No.	Name	Function	
①	Mode key	Used to change the items to be set.	
②	Enter key	Enters the data value.	
③	Up key	Used to change the data value.	
④	Down key	Used to change the data value.	
⑤	Alarm	HH	Lights while HH set.
		H	Lights while H set.
		L	Lights while L set.
		LL	Lights while LL set.
⑥	Mode	OP.	Lights while measurement mode.
		ADJ.	Lights while adjustment mode. (Without zero point mode and span point adjustment mode.)
		ALARM	Lights while alarm setting mode.
		TEST	Lights while test mode.
		ZERO	Lights while zero point adjustment mode.
		SPAN	Lights while span point adjustment mode.
⑦	Unit	Display indication unit. (Choose a use unit from the unit seal and set it.)	
⑧	Variable data	Display process value, characters identifying the data being set and error messages.	
⑨	Parameter data	Display parameter data.	
⑩	Liquid level / contents	Display liquid level / contents	
⑪	Alarm identification	Display alarm identification.	

9. OPERATION

Monitor Unit's operation, setting and calibration are done by depressing the keypad on the front panel as MODE key, ENTER key, UP key, and DOWN key.

Once you entered your desired value to the parameter, it will be saved until Change or initialization

When the MP is powered up, it automatically starts up the setting mode. Parameter's value are programmable after changing to the setting mode.

Incidentally, when ordering a sensor and Monitor Unit by the set, it sets to the electric current output by 4-20mA and 0 - 100 displays in the early stages to zero - the span point.

9.1 OPERATION

The mode composition of Monitor Unit is divided into the measurement mode and the setting mode.

Measurement mode is the mode which processes the display according to the signal of a sensor, an alarm output, a current signal, etc., and is the mode which operates in the case of use.

Setting mode is the mode which performs a display setup in measurement mode, an alarm output setup, an output test, etc. When dividing a setting mode mainly, it is divided into the following four.

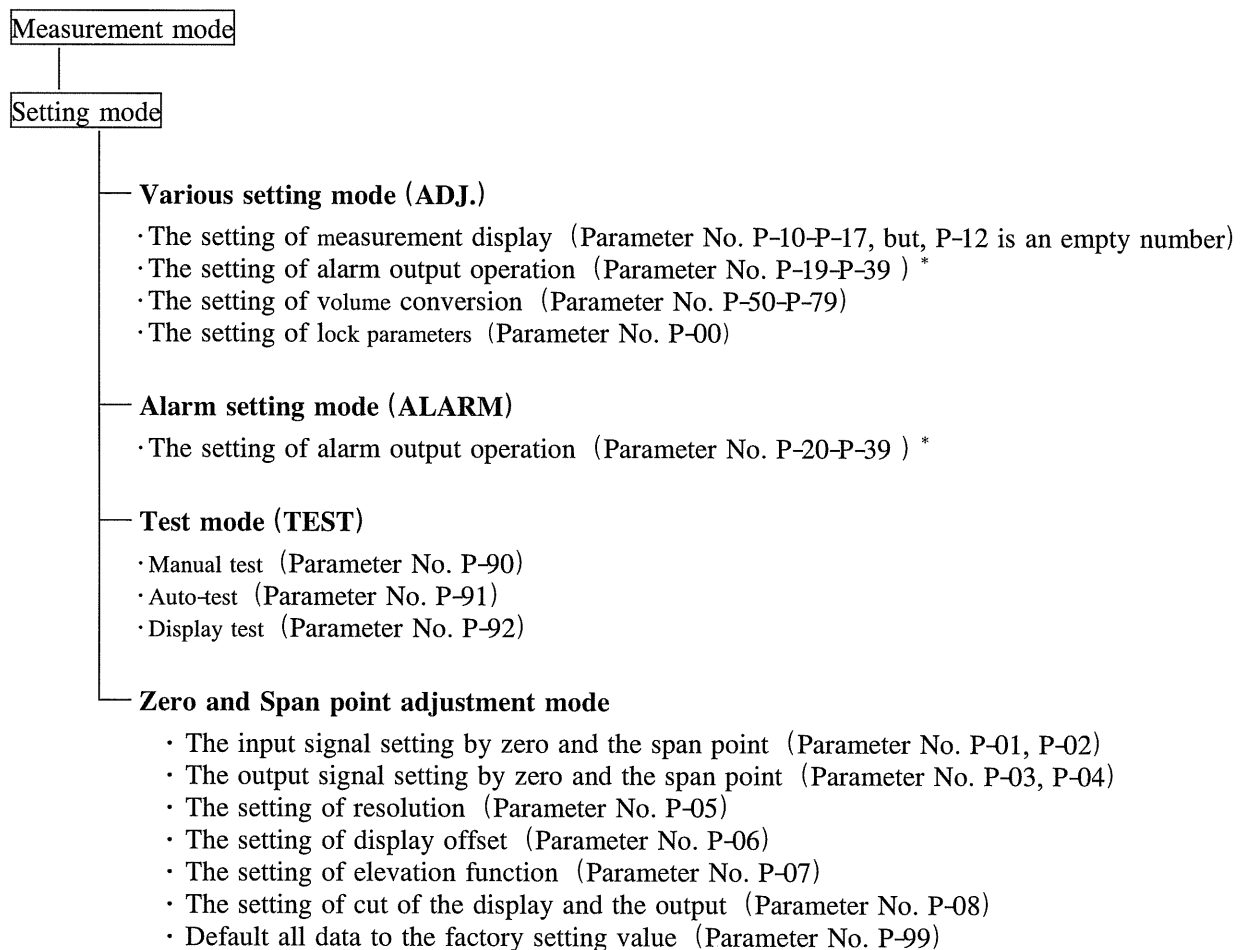

* Parameter No. P-20-P-39 can be changed in either of various setting mode (ADJ.) , Alarm setting mode (ALARM) setting.

The flow of the display contents and the changing operation

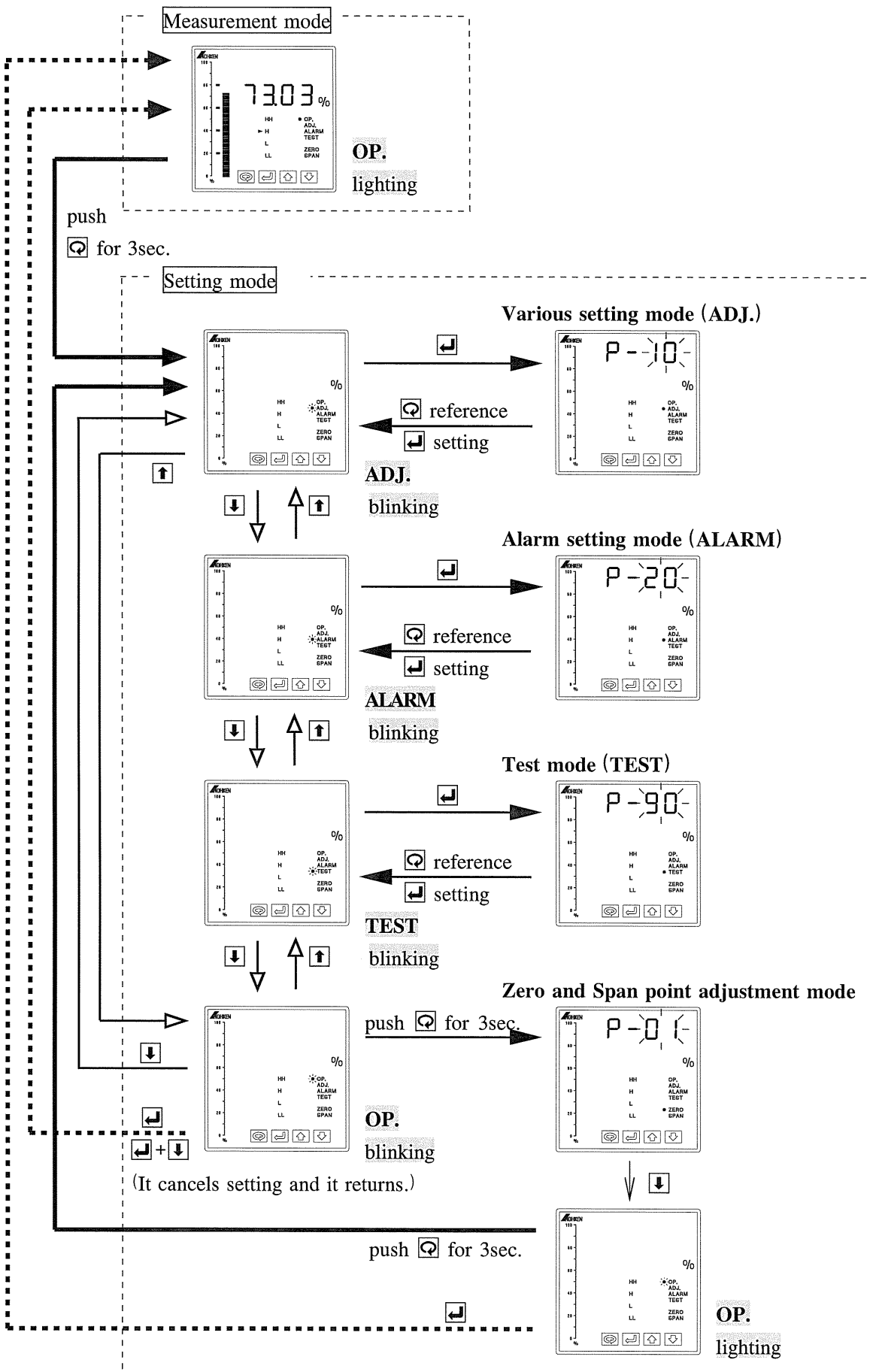

9. 2 SETTING OF MONITOR UNIT

Incidentally, when ordering a sensor and Monitor Unit by the set, it sets to the electric current output by 4-20mA and 0 - 100 displays in the early stages to zero - span point. Therefore, it is possible to use in basically setting the alarm output to hope for. A way of zero and span point adjustment and the alarm output setting is shown below.

9. 2. 1 ZERO AND SPAN POINT ADJUSTMENT

When ordering a sensor and Monitor Unit by the set, zero and span point adjustment has completed in for warding. Therefore, there is not re- adjustment's necessity.









Setting example

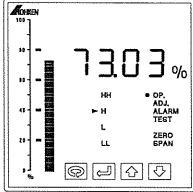

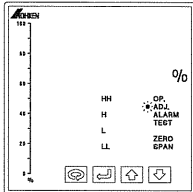

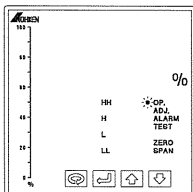

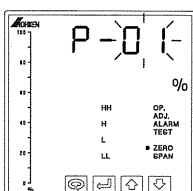



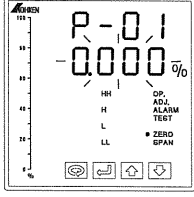

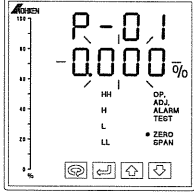

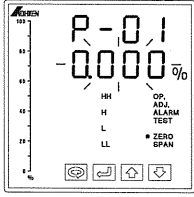

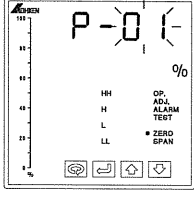

When the necessity which does zero and span point adjustment once again occurs with the size change by the sensor.

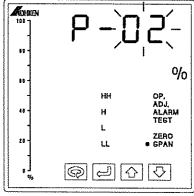

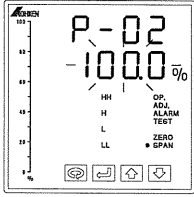

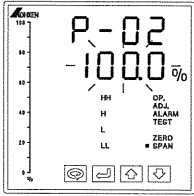

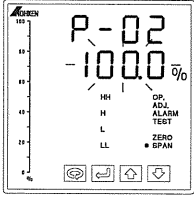

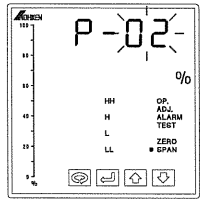

Setting contents

- ① It makes a sensor the condition that zero signal and the span point signal can be output.
- ② It makes the condition to output zero signal from the sensor and it does zero adjustment (P-01) .
- ③ It makes the condition to output a span point signal from the sensor and it does span point adjustment (P-02) .
- ④ It returns a sensor to the measurement condition.

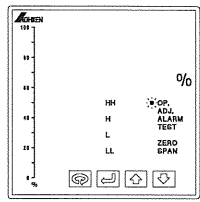
The setting change procedure (The setting change procedure of the above ② and ③)

<p>(1) It begins at the measurement mode.</p>		<p>Measurement mode "OP." lights.</p>
<p>(2) It pushes  for 3 seconds. "ADJ." blinks.</p>		<p>↓ push  for 3sec. Setting mode "ADJ." blinks.</p>
<p>(3) It pushes  . "OP." blinks.</p>		<p>↓ push  "OP." blinks.</p>
<p>(4) It pushes  for 3 seconds. "P-01" blinks. (Zero point adjustment)</p>		<p>↓ push  for 3sec. Zero and Span point adjustment mode "P-01" blinks.</p>

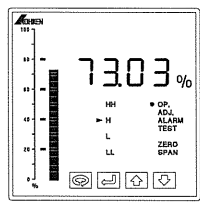
<p>(5) It pushes . The value of the zero point set up now is displayed. (If there is not a process which zero adjusted before in zero position, "0.000" will blink.)</p>		<p>↓ push </p> <p>The value of the zero point set up now is displayed.</p>
<p>(6) <u>It outputs zero point signal from the sensor.</u></p>		<p>↓</p> <p><u>Outputs zero point signal from the sensor</u></p>
<p>(7) In the case except "0.000", push and change  or  into "0.000". (If being "0.000" in (5), this work is unnecessary.)</p>		<p>↓ push  or </p> <p>"0.000" blinks.</p>
<p>(8) It pushes  while the zero point signal had been made to output from a sensor. Then, zero point signal was memorized at the memory and that "P-01" will be in a blink state. (Zero point adjustment's completion)</p>		<p><u>Outputs zero signal</u> ↓ push </p> <p>Zero point signal was memo-rized at the memory "P-01" blinks.</p>
<p>(9) It pushes . "P-02" blinks. (Span point adjustment)</p>		<p>↓ push </p> <p>"P-02" blinks.</p>
<p>(10) It pushes . The value of the span point set up now is displayed. (If there is not a process which span adjusted before in span position, "100.0" will blink.)</p>		<p>↓ push </p> <p>The value of the span point set up now is displayed.</p>
<p>(11) <u>It outputs span point signal from the sensor.</u></p>		<p>↓</p> <p><u>Outputs span point signal from the sensor</u></p>
<p>(12) In the case except "100.0", push and change  or  into "100.0". (If being "100.0" in (10), this work is unnecessary.)</p>		<p>↓ push  or </p> <p>"100.0" blinks.</p>

<p>(13) It pushes  while the span point signal had been made to output from a sensor. Then, span point signal was memorized at the memory and that "P-02" will be in a blink state. (Span point adjustment's completion)</p>		<p><u>Outputs zero signal</u> ↓ push </p> <p>Span point signal was memorized at the memory "P-02" blinks.</p>
<p>(14) It pushes  or . "OP." blinks.</p>		<p>↓ push  or </p> <p>"OP." blinks.</p>
<p>(15) When pushing , it returns to the measurement mode. (Zero and span point adjustment's completion)</p>		<p>↓ push </p> <p>Measurement mode "OP." lights. (Adjustment's completion)</p>

9. 2. 2 ALARM OUTPUT SETTING

As follows, in the early stage setting, because a alarm value is set, when changing into the setting value except this, do this setting.

Since a relay alarm operates as compared with a display value, in case it changes the parameter about display values, such as display offset (P-06) and measurement length (P-14), please re-set up the parameter about the alarm output of P-19 to P-39.





Setting example





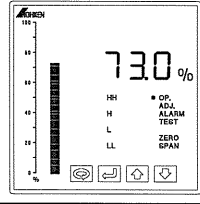

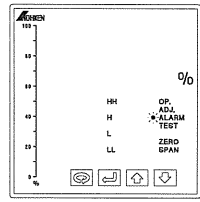



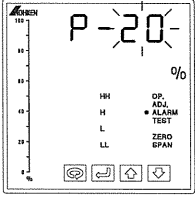

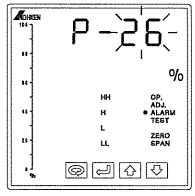

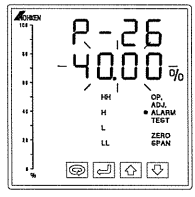



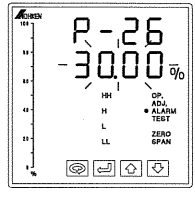



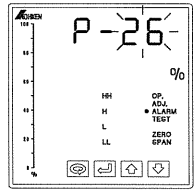

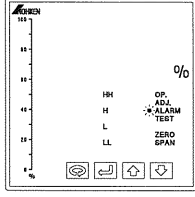
It changes L alarm into ON at less than 30 from ON at less than 40.

Setting contents

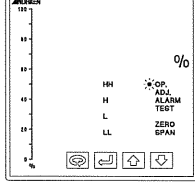
- ① It changes P-26 (the caution value of the L alarm) into 30.00 from 40.00.

The setting change procedure

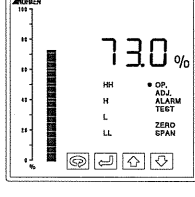
<p>(1) It begins at the measurement mode.</p>		<p>Measurement mode "OP." lights.</p>
<p>(2) It pushes  for 3 seconds. "ADJ." blinks. It pushes . "Alarm." blinks.</p>		<p>↓ push  for 3sec. push </p> <p>Setting mode "ALARM" blinks.</p>

<p>(3) It pushes . "P-20" blinks.</p>		<p>↓ push </p> <p>Alarm setting mode "P-20" blinks. (LL alarm relay operation)</p>
<p>(4)  is pushed several times and please blink "P-26". (L alarm relay setting value)</p>		<p>↓ push  several times</p> <p>"P-26" blinks. (L alarm relay setting value)</p>
<p>(5) It pushes . The setting value set up now is displayed.</p>		<p>↓ push </p> <p>"40.00" blinks.</p>
<p>(6) It pushes  or  several times and it makes display "30.00".</p>		<p>↓ push  or </p> <p>"30.00" blinks.</p>
<p>(7) It pushes . Then, setting value was memorized at the memory and that "P-26" will be in a blink state. (L alarm relay setting value is completion)</p>		<p>↓ push </p> <p>Setting value was memorized at the memory "P-26" blinks.</p>
<p>(8) It pushes . "ALARM" blinks.</p>		<p>↓ push </p> <p>"ALARM" blinks.</p>
<p>(9) It pushes  or . "OP." blinks.</p>		<p>↓ push  or </p> <p>"OP." blinks.</p>
<p>(10) When pushing , it returns to the measurement mode. (Setting change's completion)</p>		<p>↓ push </p> <p>Measurement mode "OP." lights. (Setting change's completion)</p>

* When changing the other caution value continuously, return to (4) after (7) ends and operate a parameter in the change by the similar procedure.

9. 3 CONTENTS OF PARAMETER

All the parameters of Monitor Unit are shown below. Contents about the various setting such as the change operation confirmation test of the change of the way of displaying and the alarm output operation are shown.

9. 3. 1 INPUT AND OUTPUT (P-00~P-17)

P-00. Lock : It prevents from a not carefully depending parameter change.

【default : 1965】

Parameter No.00 are called and setting values other than 1965 are inputted. A parameter will be in a lock state and it will become impossible to perform a setup and reference of a parameter. When canceling a keylock,  is pushed for 3 seconds at the time of measurement mode, and it shifts to the setting mode of a parameter P-00, and a keylock will be canceled if 1965 is inputted into a setting value.

《programmable range : 0000 ~ 9999》

P-01. Zero point adjustment : The zero point signal of a connection sensor is recognized.

【default : 0. 000】

It changes into the state where the signal of a connection sensor is inputted, and it is made to recognize by carrying out an input setup that the signal of the connection sensor is an input signal value in the setting position (comparatively at the time of setting the full scale of a sensor signal to 100). (Keep in mind that the error of Err1 will occur if it sets up by the same input signal as the span point input value of P-02.) Refer to the 9.4 clause for the release method.

Fundamentally, the input signal of a connection sensor is in the state which inputted the signal in the zero point position of a sensor, and please set up the setting value 0.000.

《programmable range : 0. 000 ~ 200. 0》

P-02. Span point adjustment : The span point signal of a connection sensor is recognized.

【default : 100. 0】

It changes into the state where the signal of a connection sensor is inputted, and it is made to recognize by carrying out an input setup that the signal of the connection sensor is an input signal value in the setting position (comparatively at the time of setting the full scale of a sensor signal to 100). (Keep in mind that the error of Err1 will occur if it sets up by the same input signal as the zero point input value of P-01.) Refer to the 9.4 clause for the release method.

Fundamentally, the input signal of a connection sensor is in the state which inputted the signal in the span point position of a sensor, and please set up the setting value 100.0.

《programmable range : 0. 000 ~ 200. 0》

P-03. Output for Zero point : The output current value in a zero point position is set up.
 【default : 04. 00】

《programmable range : 02. 00 ~ 22. 00》 [unit : mA DC]

P-04. Output for Span point : The output current value in a Span point position is set up.
 【default : 20. 00】

《programmable range : 02. 00 ~ 22. 00》 [unit : mA DC]

P-05. Resolution : Change display at desired resolution.
 【default : 0000】

It is made the output change for every resolution which set up the measurement value and the current output value.

Each resolution = Total measuring range / numbers of resolution

"0" means without resolution display.

《programmable range : 0000 ~ 2000》

P-06. Display value offset : It is used when indicating the display value by offset on the whole. The
 【default : 0. 000】 display which made the center standard zero as main uses is attained.

Setting example

before		It is set up using P-06 as 50.00.	after	
Zero point	display 0.000 output 4.00mA		Zero point	display -50.00 output 4.00mA
Span point	display 100.0 output 20.00mA		Span point	display 50.00 output 20.00mA

※ Span suppression (P-15) :0.000, Measuring range (P-14) :100.0, Zero elevation (P-13) :0.000

- Please input an input value to become "Display value offset (P-06) < Span suppression (P-15) + measuring range (P-14) + Zero elevation (P-13) ." When not satisfied, "Err2" is displayed and it becomes impossible to shift to measurement mode. Refer to the 9.4 clause for the release method.
- Since it is dependent on the numerical value set up by measurement range (P-14) , an input value should surely input this parameter after a setup of P-14.
- Since it depends for an alarm setup on a display value, please be sure to reconfirm the parameter setting value about alarm output operation of P-19 to P-39 after a setup.
- This parameter cannot indicate the display value by offset to the measurement mode {P-10 = 1 (deposition volume) or 3 (space volume) } of volume conversion.

《programmable range : 0. 000 ~ 9999》
 [unit : The unit on a surface panel (arbitrary display units)]

P-07. Elevation function : It is used when making a display value and a current output value slide on
 【 default : 0.000】 the whole.

Setting example

before		It is set up using P-07 as 100.0.	after	
Zero point	display 0.000 output 4.00mA		Zero point	display -1.000 output 3.84mA
Span point	display 100.0 output 20.00mA		Span point	display 99.00 output 19.84mA

※ Span suppression (P-15) :0.000, Measuring range (P-14) :100.0, Zero elevation (P-13) :0.000

- Since it is dependent on the numerical value set up by measurement range (P-14), an input value should surely input this parameter after a setup of P-14.
- Since it depends for an alarm setup on a display value, please be sure to reconfirm the parameter setting value about alarm output operation of P-19 to P-39 after a setup.
- It becomes effective to the total setting value of a setup (P-10) in measurement mode elevation functioning this parameter.

《programmable range : -9999 ~ 9999》

[unit : The unit on a surface panel (arbitrary display units)]

P-08. Cut function : The display and current output below a zero point and beyond a span point are
 【 default : 0】 cut.

0 : Standard

1 : It cuts below a zero point.

2 : It cuts beyond a span point.

3 : It cuts below a zero point and beyond a span point.

example) Span suppression (P-15) =0.000, Measuring range (P-14) =100.0, Zero elevation (P-13) = 0.000. In this setup, if P-08 = 3 are inputted, in below a zero point, as for a display, 0.000 and a current output will be 4.00mA, and, in beyond a span point, as for a display, 100.0 and a current output will be 20.00mA. (A current value shows a calculation value.)

- When this parameter is changed, the measurement mode of volume conversion is also influenced. When a volume conversion setup is carried out, please re-setup the value of P-50 to P-59.

《programmable range : 0 ~ 3》

P-10. Measuring mode : It chooses a measurement object.

【 default : 0 】

It calculates in the set-up measurement mode and a display, a current output, and an alarm output are performed to an operation result. A current output full scale serves as the range of measurement range (P-14) in a level display (0 or 2) at the time of selection, and, in selection of a volume display (1 or 3), even a top position serves as a range from a bottom position.

0 : Material level

1 : Material volume

2 : Space level

3 : Space volume

《programmable range : 0 ~ 3》

P-11. Decimal points : Selectable display decimal points.

【 default : 1 】

0 : no digits after the decimal point

1 : 1 digit after the decimal point

2 : 2 digits after the decimal point

3 : 3 digits after the decimal point

4 : floating point

《programmable range : 0 ~ 4》

P-13. Zero elevation : The display level from 0% position to the bottom point of a sensor input
 【 default : 0.000 】 signal is inputted.

It is used when performing the case where carry out the uniform increase of the material level display value, and it is displayed, and a material volume conversion display.

《programmable range : 0.000 ~ 9999》
 [unit : The unit on a surface panel (arbitrary display units)]

P-14. Measuring range : The display level of 0 - 100% position of full-scale one of a sensor input
 【 default : 100.0 】 signal is inputted.

The amount of change of a display level is inputted.

《programmable range : 0.000 ~ 9999》
 [unit : The unit on a surface panel (arbitrary display units)]

P-15. Span suppression : The amount of display levels from 100% position to the top point of a sensor
 【 default : 0.000 】 input signal is inputted.

It is used when performing the case where carry out the uniform increase of the space level display value, and it is displayed, and a space volume conversion display.

《programmable range : 0.000 ~ 9999》
 [unit : The unit on a surface panel (arbitrary display units)]

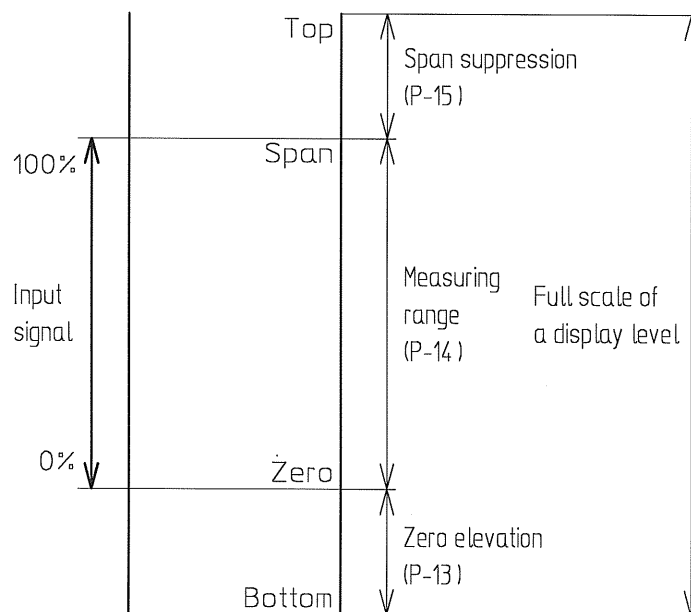

Relation between a parameter setting value and the display value range

P-16. Damping rate : It is useful to delete an excessive change over pre-setting value to avoid
 【 default : 5.000】 accidental outputs.

《programmable range : 0.001 ~ 100.0》
 [unit : % (Rate to the full scale of an input signal)]

P-17. Input filter : Input signal equalization.
 【 default : 0】

0 : Equalize 10 signals

(The value which averaged the last measurement value for 10 time is updated and outputted every about 0.3 seconds.)

1 : Equalize 100 signals tracking speed becomes slow

(The last measurement value for 10 time is summarized to one block, and the value which averaged the value of the last block for ten pieces is updated and outputted every about 3 seconds.)

3 : Equalize 30 signals tracking speed becomes slow

(The last measurement value for 10 time is summarized to one block, and the value which averaged the value of the last block for three pieces is updated and outputted every about 3 seconds.)

5 : Equalize 50 signals tracking speed becomes slow

(The last measurement value for 10 time is summarized to one block, and the value which averaged the value of the last block for five pieces is updated and outputted every about 3 seconds.)

7 : Equalize 70 signals tracking speed becomes slow

(The last measurement value for 10 time is summarized to one block, and the value which averaged the value of the last block for seven pieces is updated and outputted every about 3 seconds.)

《programmable range : 0 , 1 , 3 , 5 , 7》

9. 3. 2 ALARM OUTPUT OPERATION (P-19~P-39)

- (1) Programmable alarm relays with reference to material level of the measuring mode (0 or 1, P-10).
 (2) If you choose space level, note to the different display and setting value for alarm points.

	operation	setting value	hysteresis	ON delay timer	OFF delay timer
LL alarm relay	P-20	P-21	P-22	P-23	P-24
L alarm relay	P-25	P-26	P-27	P-28	P-29
H alarm relay	P-30	P-31	P-32	P-33	P-34
HH alarm relay	P-35	P-36	P-37	P-38	P-39

P-19. Fail-safe : Selectable fail-safe operation mode. (Refer to 7.2.)

【default : 0】

0 : Fail-safe off

1 : Fail-safe on

《programmable range : 0 , 1》

P-20. LL alarm relay operation : Programmable operation for the LL alarm relay.

【default : 2】

0 : OFF (empty)

1 : Close ON rising (normally open)

2 : Close ON falling (normally closed)

《programmable range : 0 ~ 2》

P-21. LL alarm relay setting value : Key-in desired setting value for the LL alarm relay.

【default : 20.00】 (A bottom position is inputted as a standard position.)

《programmable range : -9999 ~ 9999》

[unit : The unit on a surface panel (arbitrary display units)]

P-22. LL alarm relay hysteresis : Key-in desired hysteresis for the LL alarm relay.

【default : 0.000】

《programmable range : 0.000 ~ 9999》

[unit : The unit on a surface panel (arbitrary display units)]

P-23. LL alarm relay ON delay timer : Key-in desired ON state delay time for the LL alarm relay.

【default : 0】

《programmable range : 0 ~ 30》 [unit : seconds]

P-24. LL alarm relay OFF delay timer : Key-in desired OFF state delay time for the LL alarm relay.

【default : 0】

《programmable range : 0 ~ 30》 [unit : seconds]

P-25. L alarm relay operation : Programmable operation for the L alarm relay.

【 default : 2 】

0 : OFF (empty)

1 : Close ON rising (normally open)

2 : Close ON falling (normally closed)

《programmable range : 0 ~ 2》

P-26. L alarm relay setting value : Key-in desired setting value for the L alarm relay.

【 default : 40.00 】 (A bottom position is inputted as a standard position.)

《programmable range : -9999 ~ 9999》

[unit : The unit on a surface panel (arbitrary display units)]

P-27. L alarm relay hysteresis : Key-in desired hysteresis for the L alarm relay.

【 default : 0.000 】

《programmable range : 0.000 ~ 9999》

[unit : The unit on a surface panel (arbitrary display units)]

P-28. L alarm relay ON delay timer : Key-in desired ON state delay time for the L alarm relay.

【 default : 0 】

《programmable range : 0 ~ 30》 [unit : seconds]

P-29. L alarm relay OFF delay timer : Key-in desired OFF state delay time for the L alarm relay.

【 default : 0 】

《programmable range : 0 ~ 30》 [unit : seconds]

P-30. H alarm relay operation : Programmable operation for the H alarm relay.

【default : 1】

0 : OFF (empty)

1 : Close ON rising (normally open)

2 : Close ON falling (normally closed)

《programmable range : 0 ~ 2》

P-31. H alarm relay setting value : Key-in desired setting value for the H alarm relay.

【default : 60.00】 (A bottom position is inputted as a standard position.)

《programmable range : -9999 ~ 9999》

[unit : The unit on a surface panel (arbitrary display units)]

P-32. H alarm relay hysteresis : Key-in desired hysteresis for the H alarm relay.

【default : 0.000】

《programmable range : 0.000 ~ 9999》

[unit : The unit on a surface panel (arbitrary display units)]

P-33. H alarm relay ON delay timer : Key-in desired ON state delay time for the H alarm relay.

【default : 0】

《programmable range : 0 ~ 30》 [unit : seconds]

P-34. H alarm relay OFF delay timer : Key-in desired OFF state delay time for the H alarm relay.

【default : 0】

《programmable range : 0 ~ 30》 [unit : seconds]

P-35. HH alarm relay operation : Programmable operation for the HH alarm relay.

【default : 1】

0 : OFF (empty)

1 : Close ON rising (normally open)

2 : Close ON falling (normally closed)

《programmable range : 0 ~ 2》

P-36. HH alarm relay setting value : Key-in desired setting value for the HH alarm relay.

【default : 80.00】 (A bottom position is inputted as a standard position.)

《programmable range : -9999 ~ 9999》

[unit : The unit on a surface panel (arbitrary display units)]

P-37. HH alarm relay hysteresis : Key-in desired hysteresis for the HH alarm relay.

【default : 0.000】

《programmable range : 0.000 ~ 9999》

[unit : The unit on a surface panel (arbitrary display units)]

P-38. HH alarm relay ON delay timer : Key-in desired ON state delay time for the HH alarm relay.

【default : 0】

《programmable range : 0 ~ 30》 [unit : seconds]

P-39. HH alarm relay OFF delay timer : Key-in desired OFF state delay time for the HH alarm relay.

【default : 0】

《programmable range : 0 ~ 30》 [unit : seconds]

9. 3. 3 VOLUME CONVERSION (P-50~P-59)

- (1) A display is provided which is proportional to the level of the tank for those seven common tank shapes. You just input parameters related to your desired tank shape. We recommend to keep default volume for P-58 (conversion factor "C") and P-59 (Conversion multiplier "P") if unnecessary.
- (2) Total of P-13, P-14, and P-15 should be equal to total length of the tank.
- (3) Choose your suitable tank shape below.

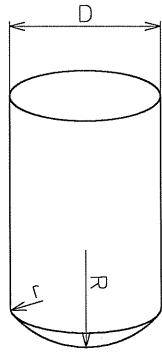

0 : Spherical bottom

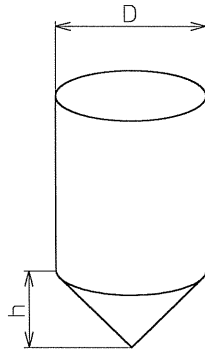

1 : Conic bottom

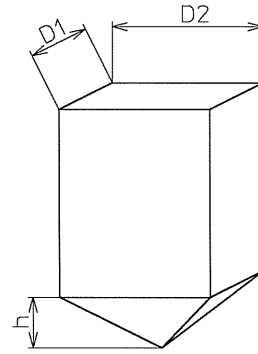

2 : Pyramidal bottom

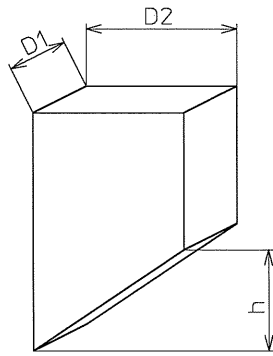

3 : Sloped bottom

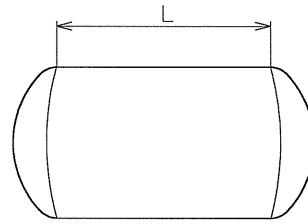

4 : Parabolic ends

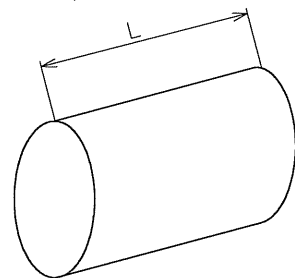

5 : Flat end

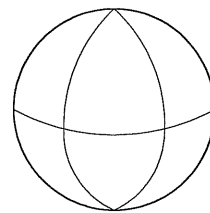

6 : Sphere

The tank form figure and each input size position in capacity conversion

- (4) For the tank number 3, enter carefully to P-55 ("D1") and P-56 ("D2"). Check the correct orientation with the drawing.

- (5) Following are automatically converted when you enter the half paraborized end of tank number 4. Since it becomes a factor with error when conditions differ, please examine using a linear display etc.

Diameter of the cylinder: $DD = (\text{Zero elevation}) + (\text{Measuring range}) + (\text{Span suppression})$

Radius of the half paraborized end: RR

Rounded corner of the half paraborized end: rr (Note: RR:rr = 2:1)

Height of the half paraborized end: hh (Note: hh = 1/4DD)

- (6) If capacity conversion are performed, the full scale of a current output will be changed into a top position from a bottom position. Keep in mind that it differs from the case of level conversion (a sensor measurement region is made into a full scale) .

P-50. Selectable tank shape : Choose your desired tank from those seven common tank shapes.
【default : 0】

When performing a volume conversion setup, it is necessary to change a setup of P-10 (measurement mode) into 1 (or 3) simultaneously.

- 0: Spherical bottom
- 1: Conic bottom
- 2: Pyramidal bottom
- 3: Sloped bottom
- 4: Parabolic ends
- 5: Flat end
- 6: Sphere
- 9: Linear

《programmable range : 0 ~ 9》

P-51. Tank dimension D : Enter the diameter of the tank if P-50 = 0 or 1.
【default : 1.000】

《programmable range : 0.000 ~ 9999》

[unit : The unit inputted by P-14 (measurement range)]

P-52. Tank dimension R : Enter the radius of the parabolic bottom if P-50 = 0.
【default : 1.000】

《programmable range : 0.000 ~ 9999》

[unit : The unit inputted by P-14 (measurement range)]

P-53. Tank dimension r : Enter the radius of rounded ends of the tank if P-50 = 0.
【default : 0.100】

《programmable range : 0.000 ~ 9999》
[unit : The unit inputted by P-14 (measurement range)]

P-54. Tank dimension h : Enter the height of bottom section of the tank if P-50 = 1,2,3.
【default : 0.500】

《programmable range : 0.000 ~ 9999》
[unit : The unit inputted by P-14 (measurement range)]

P-55. Tank dimension D1 : Enter the depth of tank if P-50 = 2,3.
【default : 1.000】

《programmable range : 0.000 ~ 9999》
[unit : The unit inputted by P-14 (measurement range)]

P-56. Tank dimension D2 : Enter the depth of tank if P-50 = 2,3.
【default : 1.000】

《programmable range : 0.000 ~ 9999》
[unit : The unit inputted by P-14 (measurement range)]

P-57. Tank dimension L : Enter the horizontal length of tank if P-50 = 4,5.
【default : 1.000】

《programmable range : 0.000 ~ 9999》
[unit : The unit inputted by P-14 (measurement range)]

P-58. Conversion factor C : Enter the factor the conversion value to be multiplied.
【default : 1.000】

《programmable range : 0.000 ~ 9999》

P-59. Conversion multiplier P : Enter the multiplier the conversion value must be multiplied to 1×10^7 .
【default : 0.000】

《programmable range : 0.000 ~ 9999》

9. 3. 4 LINEAR PROFILE (P-60~P-79)

- (1) If your tank design does not match one of the seven common tank shapes, it can be programmed as eleven separate breakpoint settings, including zero point and span point.
Parameter number from P-60 to P-79 is those breakpoint settings.
- (2) The tank profile is achieved by entering the level (linearization "X") and corresponding volume (linearization "Y") for each breakpoint.
- (3) If capacity conversion are performed, the full scale of a current output will be changed into a top position from a bottom position. Keep in mind that it differs from the case of level conversion (a sensor measurement region is made into a full scale) .

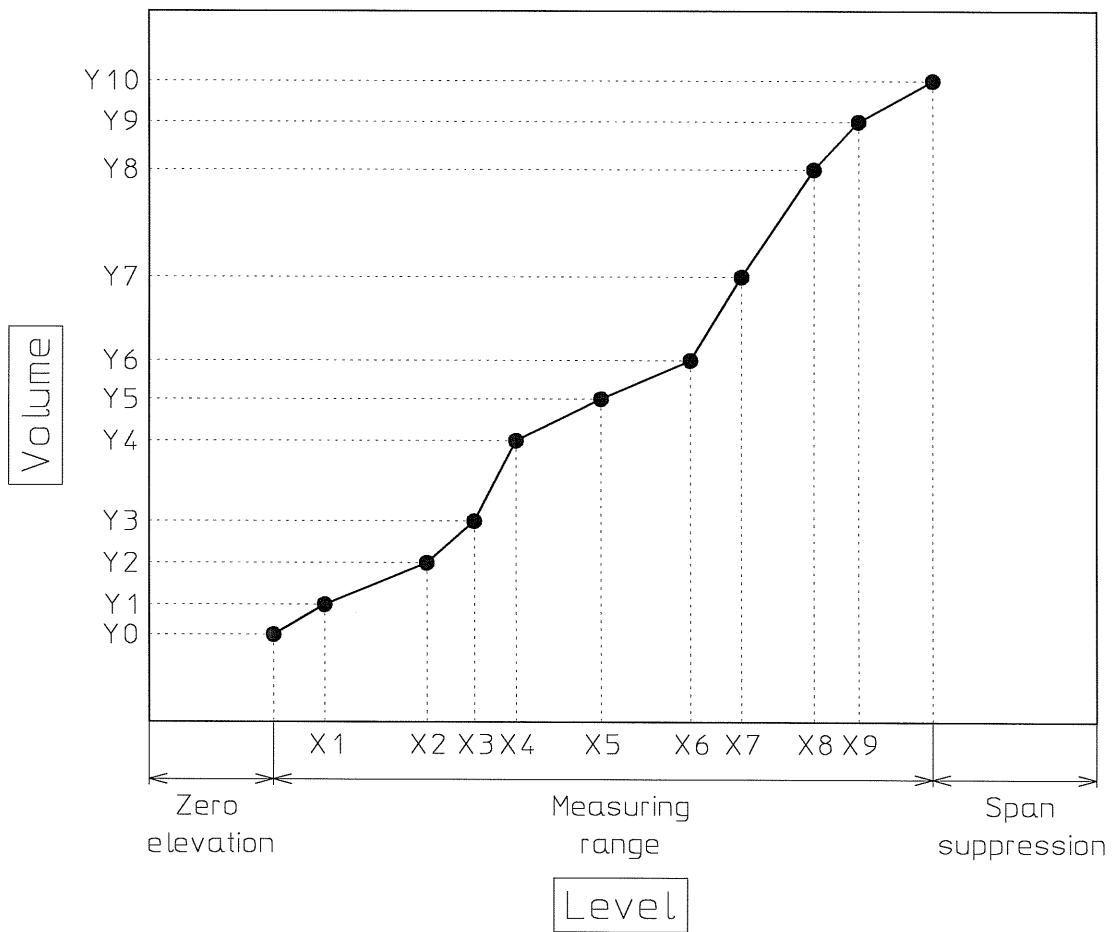

Relation between the linearization "X" and the linearization "Y"

P-60. Level breakpoint X1 : Enter the level data X1.
【default : 10.00】

P-61. Level breakpoint X2 : Enter the level data X2.
【default : 20.00】

P-62. Level breakpoint X3 : Enter the level data X3.
【default : 30.00】

P-63. Level breakpoint X4 : Enter the level data X4.
【default : 40.00】

P-64. Level breakpoint X5 : Enter the level data X5.
【default : 50.00】

P-65. Level breakpoint X6 : Enter the level data X6.
【default : 60.00】

P-66. Level breakpoint X7 : Enter the level data X7.
【default : 70.00】

P-67. Level breakpoint X8 : Enter the level data X8.
【default : 80.00】

P-68. Level breakpoint X9 : Enter the level data X9.
【default : 90.00】

- The range which can be inputted and unit to P-60 to P-68 are as follows.
《programmable range : 0.000 ~ 9999》
[unit : The unit inputted by P-14 (measurement range)]
- In addition, data inputs a value including Zero elevation (P-13) and the Span suppression (P-15) .

P-69. Breakpoint volume Y0 : Enter the volume data for Zero point.
【default : 0.000】

P-70. Breakpoint volume Y1 : Enter the volume data for breakpoint X1.
【default : 1.000】

P-71. Breakpoint volume Y2 : Enter the volume data for breakpoint X2.
【default : 2.000】

P-72. Breakpoint volume Y3 : Enter the volume data for breakpoint X3.
【default : 3.000】

P-73. Breakpoint volume Y4 : Enter the volume data for breakpoint X4.
【default : 4.000】

P-74. Breakpoint volume Y5 : Enter the volume data for breakpoint X5.
【default : 5.000】

P-75. Breakpoint volume Y6 : Enter the volume data for breakpoint X6.
【default : 6.000】

P-76. Breakpoint volume Y7 : Enter the volume data for breakpoint X7.
【default : 7.000】

P-77. Breakpoint volume Y8 : Enter the volume data for breakpoint X8.
【default : 8.000】

P-78. Breakpoint volume Y9 : Enter the volume data for breakpoint X9.
【default : 9.000】

P-79. Breakpoint volume Y10 : Enter the volume data for Span point.
【default : 10.00】

- The range which can be inputted and unit to P-69 to P-79 are as follows.
《programmable range : 0.000 ~ 9999》
[unit : The unit inputted by P-14 (measurement range)]
- In addition, data inputs a value including Zero elevation (P-13) and the Span suppression (P-15) .

9.3.5 CHECK TEST OF OPERATION (P-90~P-92)

P-90. Manual test mode : Check for output current status and relay output status by entering your desired value in manual.

Output should be in proportional to your input value.

Enter desired numeric value within the range of from Zero to Span.

Do not enter below Zero or over Span.

P-91. Auto-test mode : Output current and relay repeatedly from zero and span.

P-92. Display test : The display test of LED is performed.

"P-92" indication and all display on LED are alternately flashed. You can check each one segment by depressing . You can check all display at the same time by depressing .

9.3.6 INITIALIZATION (P-99)

P-99. Initialization : A parameter is returned to a setup of factory shipments.

【default : 1999】

Initialize all parameters to default (factory setting) by entering 1965. It returns to the setting value specified when the contents of a parameter of a monitor unit were specified in advance.

When there is no specification especially, it returns to the initial value of standard of our company.

《programmable range : 0000 ~ 9999》

9.4 ERROR MESSAGE



If an error arises, an error message appears as follows.

Display	Message	Action
E r r 1	• Cable of input line is broken	• Wire correctly
	• Input value is overflow	• Check for the rating of input signal. • Check for the operation status of the sensor.
E r r 2	• Improper calibration of Zero or Span	• Re-calibrate. Do not key-in same value for both Zero and Span.
E r r 3	• Measuring computation error	• Check for all input value to correct.
E r r 4	• Internal MPU malfunction	• Ask to our Service department.



To reset system error:

E r r 1 : Wire correctly for the input line, or repair input signal correctly.

(NOTE: Error does not appear when you choose analog input as 4-20 mA DC.)

E r r 2 : Depress  +  at the same time, and re-calibrate Zero and Span.

E r r 3 : Depress  over 3 seconds, and check for all parameter value.

E r r 4 : Depress  +  at the same time to delete error message.

If unsuccessful, ask to our Service department.

9.5 PARAMETER LIST

Please use it as a write-in paper at the time of setting up a parameter.

P-No.	Parameter item	【default】	setting value	P-No.	Parameter item	【default】	setting value
P-01	Zero point adjustment	【0.000】		P-50	Selectable tank shape	【 0 】	
P-02	Span point adjustment	【100.0】		P-51	Tank dimension D	【1.000】	
P-03	Output for Zero point	【04.00】		P-52	Tank dimension R	【1.000】	
P-04	Output for Span point	【20.00】		P-53	Tank dimension r	【0.100】	
P-05	Resolution	【 0 】		P-54	Tank dimension h	【0.500】	
P-06	Display value offset	【0.000】		P-55	Tank dimension D1	【1.000】	
P-07	Elevation function	【0.000】		P-56	Tank dimension D2	【1.000】	
P-08	Cut function	【 0 】		P-57	Tank dimension L	【1.000】	
				P-58	Conversion factor C	【1.000】	
P-10	Measuring mode	【 0 】		P-59	Conversion multiplier P	【0.000】	
P-11	Decimal points	【 1 】					
P-13	Zero elevation	【0.000】		P-60	Level breakpoint X1	【10.00】	
P-14	Measuring range	【100.0】		P-61	Level breakpoint X2	【20.00】	
P-15	Span suppression	【0.000】		P-62	Level breakpoint X3	【30.00】	
P-16	Damping rate	【5.000】		P-63	Level breakpoint X4	【40.00】	
P-17	Input filter	【 0 】		P-64	Level breakpoint X5	【50.00】	
P-19	Fail-safe	【 0 】		P-65	Level breakpoint X6	【60.00】	
				P-66	Level breakpoint X7	【70.00】	
P-20	LL alarm relay operation	【 2 】		P-67	Level breakpoint X8	【80.00】	
P-21	LL alarm relay setting value	【20.00】		P-68	Level breakpoint X9	【90.00】	
P-22	LL alarm relay hysteresis	【0.000】					
P-23	LL alarm relay ON delay timer	【 0 】		P-69	Breakpoint volume Y0	【0.000】	
P-24	LL alarm relay OFF delay timer	【 0 】		P-70	Breakpoint volume Y1	【1.000】	
P-25	L alarm relay operation	【 2 】		P-71	Breakpoint volume Y2	【2.000】	
P-26	L alarm relay setting value	【40.00】		P-72	Breakpoint volume Y3	【3.000】	
P-27	L alarm relay hysteresis	【0.000】		P-73	Breakpoint volume Y4	【4.000】	
P-28	L alarm relay ON delay timer	【 0 】		P-74	Breakpoint volume Y5	【5.000】	
P-29	L alarm relay OFF delay timer	【 0 】		P-75	Breakpoint volume Y6	【6.000】	
P-30	H alarm relay operation	【 1 】		P-76	Breakpoint volume Y7	【7.000】	
P-31	H alarm relay setting value	【60.00】		P-77	Breakpoint volume Y8	【8.000】	
P-32	H alarm relay hysteresis	【0.000】		P-78	Breakpoint volume Y9	【9.000】	
P-33	H alarm relay ON delay timer	【 0 】		P-79	Breakpoint volume Y10	【10.00】	
P-34	H alarm relay OFF delay timer	【 0 】					
P-35	HH alarm relay operation	【 1 】		P-90	Manual test mode		
P-36	HH alarm relay setting value	【80.00】		P-91	Auto-test mode		
P-37	HH alarm relay hysteresis	【0.000】		P-92	Display test		
P-38	HH alarm relay ON delay timer	【 0 】		P-99	Initialization	【1999】	
P-39	HH alarm relay OFF delay timer	【 0 】		P-00	Lock	【1965】	

10. MAINTENANCE

Please perform maintenance check once in one year from half a year. However, this frequency is a standard to the last. If there is a difference in operating frequency, temperature, an operating condition, etc., it is necessary to carry out more frequently than this.

- (1) Please use a tool and check that the Monitor Unit is being firmly fixed by the attachment implement. When you are loosening, please refasten by the tool.
- (2) Please check that the actual measurement of a surface and the display value of a Monitor Unit are in agreement in the state of measurement. When a value shifts, please perform zero span point adjustment, and check that directions are in agreement.
- (3) Please call the test parameter of P-90 (or P-91) , and check the display value by variable. Since this display value is interlocked with and an output current value and an alarm output operate, please also check the state of the load to connect of operation and check that there is no incorrect operation.
- (4) Please call the display test of P-92 and check whether there are any abnormalities in the display of LED.

11. STORAGE

The sensor shall be stored under the following conditions when it is not used for a long time.

(1) ENVIRONMENTAL CONDITIONS

- temperature : -5 ~ + 50 °C
- humidity : 85 % RH Max.(No condensing)
- No excessive vibration.
- No corrosive atmosphere such as NH₃, SO₂, Cl₂ etc.

(2) Locate away from rain and jetting water. The MP is not a drip-proof construction.

(3) Do not put things on the level controller. It will deform and damage the product.

REFERENCE: Keep the sensor in sealed plastic bags with desiccant or other moisture-proof packing.

12. TROUBLESHOOTING

Representative symptoms and remedies are shown on the table below. If following remedies are unsuccessful, or in doubt, ask our sales department. Check and record the model number and serial number on the nameplate.

Symptoms	Possible causes	Remedies	Reference
No display	Loose terminals of the power supply or miswiring.	Wire correctly.	「7.WIRING」 P6 ~ P8
	No or insufficient power supplied.	Supply or repair the power.	
Reading does not change, but level does	Loose terminals of the output or miswiring.	Wire correctly.	「7.WIRING」 P6 ~ P8 「9.OPERATION」 P10 ~ P34
	Wrong parameter values entered.	Enter correctly.	
No output alarm	Loose terminals of relay alarms or miswiring.	Wire correctly.	「7.WIRING」 P6 ~ P8 「9.OPERATION」 P10 ~ P34
	Wrong parameter values entered.	Enter correctly.	
No output signal	Loose terminals of the output or miswiring.	Wire correctly.	「7.WIRING」 P6 ~ P8
Output signal does not change, but level does	Wrong parameter values entered.	Enter correctly.	「9.OPERATION」 P10 ~ P34

NOHKEN INC.

HEAD OFFICE : 15-29,Hiroshiba-cho,Suita-city,Osaka 564-0052,Japan.

TEL:06-6386-8141 FAX:06-6386-8140

TOKYO BRANCH OFFICE : 67,Kandasakumagashi,Chiyoda-ku,Tokyo 101-0026,Japan.

TEL:03-5835-3311 FAX:03-5835-3316

NAGOYA OFFICE : 3-10-17,Uchiyama,Chikusa-ku,Nagoya-city,Aichi 464-0075,Japan.

TEL:052-731-5751 FAX:052-731-5780

KYUSHU OFFICE : 14-1,2-chome,Asano,Kokurakita-ku,Kitakyushu-city,Fukuoka 802-0001,Japan.

TEL:093-521-9830 FAX:093-521-9834