



OWNER'S MANUAL

AM-TBR Turbidimeter

Water Analytics
100 School Street
Andover, MA 01810
Phone: 749-9949
Toll free: 855-766-7623

DECLARATION OF CONFORMITY

Application of Council Directive
Standards to Which Conformity is Declared:

- Product Safety** - Tested and passed ETL (tested to UL 61010B-1), 1st Edition, Dated January 24, 2003
- Tested and passed ETLc (tested to CSA C22.2#1010.1-92)
 - Tested and passed CE to IEC 61010-1: 2001 Edition 2.0

Emissions & Immunity – Tested and passed EN61326-1:2006

Manufacturer's Name: Water Analytics, Inc.
Manufacturer's Address: 100 School Street, Andover, MA 01810
Importer's Name:
Importer's Address:
Type of Equipment: Process Turbidimeter
Model No: AM-TBR

I, the undersigned, hereby declare that the equipment specified above conforms to the above Directive and Standard



Mark Spencer, President

| | |
|--|-----------|
| 1. OVERVIEW | 2 |
| 1.1. The AM-TBR Series..... | 2 |
| 1.2. Unpacking and Inspection of the Instrument and Accessories..... | 2 |
| 1.3. The Display..... | 3 |
| 1.4. The Touch Pad..... | 3 |
| 1.5. Vapor Purge..... | 4 |
| 2. SAFETY | 5 |
| 3. INSTALLATION AND COMMISSIONING..... | 5 |
| 3.1. Mounting & Site Selection | 5 |
| 3.2. Plumbing..... | 6 |
| 3.2.1. Drain Vent:..... | 7 |
| 3.2.2. Wetted Materials:..... | 8 |
| 3.3. Electrical Connections..... | 8 |
| 3.3.1. Power..... | 9 |
| 3.3.2. RS-485..... | 9 |
| 3.3.3. Relays..... | 9 |
| 3.3.4. 4-20 mA..... | 10 |
| 4. OPERATION | 11 |
| 4.1. Routine Measurement | 11 |
| 4.2. Security Access Feature..... | 11 |
| 5. INSTRUMENT CALIBRATION | 13 |
| 5.1. Calibration Standards..... | 13 |
| 5.2. Calibration Procedures..... | 13 |
| 5.3. Calibration Error..... | 15 |
| 6. INSTRUMENT OFFSET | 16 |
| 6.1. Indexing Calibration Cuvettes..... | 17 |
| 6.2. Restoring Factory Settings..... | 17 |

| | |
|--|-----------|
| 7. INSTRUMENT CONFIGURATION (CONFIG MODE) | 18 |
| 7.1. Selecting the Output (O/P)..... | 18 |
| 7.2. Setting the 4-20 mA..... | 18 |
| 7.3. Configuring the Error Level..... | 19 |
| 7.4. Configuring the RS-485 Port | 19 |
| 7.5. Configuring the Alarms..... | 20 |
| 7.5.1. Alarm 1 | 21 |
| 7.5.2. Alarm 2 | 22 |
| 7.6. Offset Calibration..... | 22 |
| 7.7. Enabling the Security Access..... | 22 |
| 7.8. Extended Settings | 22 |
| 7.9. Speed of Response | 22 |
| 7.10. Displayed Resolution..... | 23 |
| 7.11. LCD Backlight Brightness | 23 |
| 7.12. Setting the Units..... | 24 |
| 7.13. Ultrasonic Cleaning..... | 24 |
| 7.14. RS-485 Parameters..... | 24 |
| 7.15. Desiccant Alarm | 25 |
| 7.16. 4mA Adjustment | 26 |
| 7.17. 20mA Adjustment | 26 |
| 7.18. Saving Configuration Settings..... | 26 |
| 8. ADDITIONAL FEATURES AND OPTIONS | 27 |
| 8.1. Backlit LCD..... | 27 |
| 8.2. Ultrasonic Cleaning..... | 27 |
| 8.3. RS-485 Outputs..... | 28 |
| 8.3.1. Water Analytics Online (WA catalog # 19783) | 28 |
| 8.3.2. Simple Communication | 28 |
| 8.3.3. Modbus Communication..... | 29 |
| 8.4. Flow Alarm (Catalog # 19945A) | 29 |
| 8.5. Flow Controller (Catalog # 19778) | 29 |

| | |
|---|-----------|
| 8.6. Remote Panel Meter (Catalog # 19609) | 29 |
| 9. TROUBLESHOOTING & MAINTENANCE | 30 |
| 9.1. AM-TBR Fault Detection | 30 |
| 9.2. System FAIL Message | 30 |
| 9.3. Diagnostic Chart..... | 31 |
| 9.4. Technical and Customer Assistance..... | 31 |
| 10. ROUTINE MAINTENANCE | 33 |
| 10.1. Cleaning the Flow Through Cuvette | 33 |
| 10.2. Replacing or Installing the Desiccant Pouch..... | 33 |
| 10.3. Replacing the Source Lamp..... | 2 |
| 11. ACCESSORIES AND REPLACEMENT PARTS LIST | 2 |
| 12. WARRANTY..... | 3 |

Specifications

| | |
|---|--|
| Measurement Range | 0 – 1000.0 NTU 0 – 100 NTU (Model 20055 & 20056) |
| Accuracy | ±2% of reading or ±0.02 NTU below 40 NTU whichever is greater ±5% of reading above 40 NTU |
| Resolution | 0.0001 NTU (below 10 NTU) |
| Response Time | Adjustable |
| Display | Multi-Line Liquid Crystal Backlit Display |
| Alarms | Two Programmable, 120-240VAC 2A Form C Relay |
| Analog Output | Powered 4-20 mA, 600 Ω drive |
| Communications Port | Bi-directional RS-485, Modbus |
| Maximum Water Pressure | Integral pressure regulator rated 1380kPa (200 PSI.) Also refer to Flow Rate |
| Flow Rate | 100 ml/min. – 1 liter/min. (.026-.26 Gal/min) |
| Operating Temperature | 1°C – 50°C (34°F – 122°F) |
| Wetted Materials | Nylon, Borosilicate Glass, Silicon, Polypropylene, Stainless Steel |
| Sample Temperature Range | 1°C – 50°C (34°F – 122°F) |
| Power Supply | 100 – 240 VAC, 47 – 63 Hz, 80VA |
| Insulation Rating | Double Insulated, Pollution Degree 2, Overvoltage Category II |
| Environmental Conditions | Not recommended for outdoor use. Altitude up to 2000 meters. Up to 95 % RH (non-condensing). |
| Enclosure Rating | Designed to meet IP 66 /NEMA 4X |
| Regulatory Compliance And Certifications | White Light Version compliant to U.S. EPA 180.1 Infrared Version compliant to ISO 7027 CE Approved, ETL listed to UL 61010B-1 & ETL Certified to CSA 22.2 No. 1010-1-92 |
| Shipping Weight | 2.5 kg (5.5 lbs.) |
| Warranty | 2 Years from date of shipment |

1. Overview

The AM-TBR process turbidimeter allows for the measurement of the turbidity of process water on-line. The white light AM-TBR has been designed to meet the design criteria specified by the US EPA 180.1 on turbidity measurement. The infrared AM-TBR was designed to meet the design criteria specified in ISO 7027 and DIN 27027 for the measurement of the turbidity of a sample. All models have long life lamps.

Some models have ultrasonic cleaning. Refer to 8.2 for more information.

A pressure regulator on the incoming line is standard on all AM-TBR models and will reduce pressures up to 1380kPa (200 PSI) down to (104kPa) 15 PSI.

1.1. The AM-TBR Series

The AM-TBR series instruments have two light source options available, and two range options available. The only other options are the built-in ultrasonic cleaning, and the flow alarm relay. All units have user selectable 4-20 mA or Modbus over RS-485 outputs. Refer to the table below to determine which factory installed options are available. Add the postfix –A to the model number for the alarm option.

| Model Number | Illumination Type | Range NTU | Ultrasonic Cleaning |
|--------------|-------------------|-----------|---------------------|
| AM-TBR2 WL | White Light | 0-1000 | No |
| AM-TBR2 IR | Infrared | 0-1000 | No |
| | | | |
| AM-TBR3 WL | White Light | 0-100 | Yes |
| AM-TBR3 IR | Infrared | 0-100 | Yes |
| | | | |
| AM-TBR4 WL | White Light | 0-1000 | Yes |
| AM-TBR4 IR | Infrared | 0-1000 | Yes |

1.2. Unpacking and Inspection of the Instrument and Accessories

The table below indicates the items in the turbidimeter shipment.

| Item | Quantity |
|--|----------|
| AM-TBR Turbidimeter c/w Field Terminal Box & Flow Through Assembly | 1 |
| Instruction Manual | 1 |
| Desiccant Pack | 1 |
| Cuvette (Single Pack) | 1* |
| Tubing Kit: 1-shutoff clamp 1-backpressure valve 2-connecting tubing with fittings for flow through assembly 1-drain vent screw (used in pressurized systems) | 1 |

**Note: The spare cuvette (single pack) is only included for models AM-TBR2.*

Remove the instrument from the packing carton. Carefully inspect all items to ensure that no visible damage has occurred during shipment. If the items received do not match the order, please immediately contact the local distributor or the Water Analytics Customer Service department.

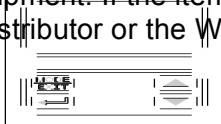

1.3. The Display

Figure 1 illustrates all the items that can appear on the display. The upper row of the display (1) is used for reporting the turbidity levels and to provide user guidance in the customer setting routine. The lower row of the display (2) is used to communicate error messages and provide user guidance. The display has two icons (3) that are used to indicate the use of access code and offset mode. In addition, mode arrows (4) are used to indicate the current instrument operating mode; AUTO (normal operation), CAL (calibration) and CONFIG (configuration).

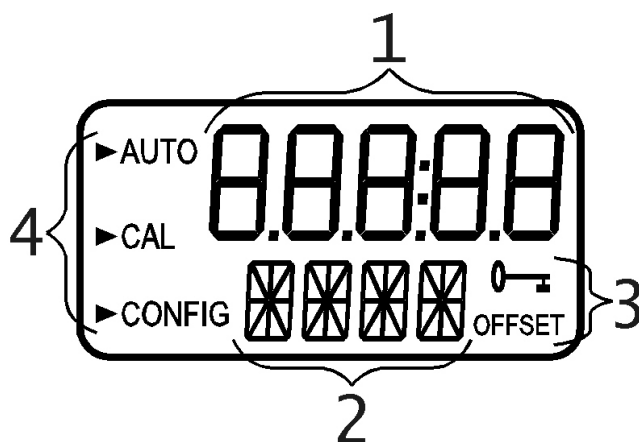







Figure 1 - Display used in the instrument.
All items used on the display are shown in this

1.4. The Touch Pad

Figure 2 illustrates the touch pad. The touch pad has four buttons: **MODE/EXIT**, , , and . The **MODE/EXIT** button is used to cycle between the three operational modes of the instrument: **CAL**, **CONFIG**, and **AUTO** (Measurement) mode. The  button enters the option (or mode that is highlighted or chosen. The  and  buttons are used to change settings.

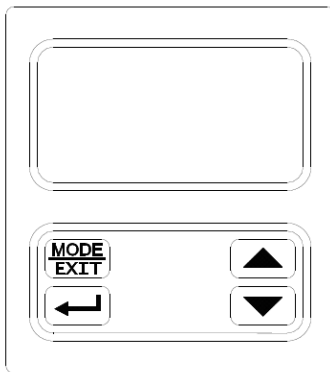

Figure 2 - Touch Pad

1.5. Vapor Purge

The AM-TBR is equipped with a continuous vapor purge system. A replaceable desiccant pouch in the lower portion of the instrument dries the air. System heat is used to warm the air. A fan inside the instrument continuously circulates heated dry air around the optical well and the flow through cuvette. This feature eliminates the need for a dry purge line.

The AM-TBR monitors the replaceable desiccant pouch condition continuously. The LCD display will show **DESC** on the lower line in the event that the desiccant pouch needs replacement. Replacement desiccant pouches are available from Water Analytics or the local representative (Part# 21555R). Refer to section 10.2

The desiccant can activate an alarm to notify the operator of a saturated desiccant. See section 7.15.

Note: Prior to installing the desiccant pouch for the first time the shipping support must be removed. This tube can be discarded after installation.

2. Safety

This manual contains basic instructions that must be followed during the commissioning, operation, care and maintenance of the instrument. The safety protection provided by this equipment may be impaired if it is commissioned and/or used in a manner not described in this manual. Consequently, all responsible personnel must read this manual prior to working with this instrument.

In certain instances **Notes**, or helpful hints, have been highlighted to give further clarification to the instructions. Refer to the *Table of Contents* to easily find specific topics and to learn about unfamiliar terms.

3. Installation and Commissioning

Prior to use for the first time, the supplied desiccant pouch will need to be installed. Refer to section 10.2.

3.1. Mounting & Site Selection

The instrument is designed for wall mounting. If wall mounting is not practical, the instrument can be mounted on any suitable level surface. For ease of service there should be about 20 cm (8") free area above the instrument; this will ensure enough room for calibration and cuvette maintenance. Choose a location that is easily accessible for operation and service and ensure that the front display rests at eye level. The overall mounting dimensions of the instrument are shown in Figure 3. The recommended mounting screws are M6 ($\frac{1}{4}$ ") for the instrument enclosure and M4 (#8) for the field terminal box. The AM-TBR is designed to have the field terminal box cradled under the sensor portion of the instrument. It is recommended that the field terminal box be mounted first, and then the rest of the instrument be mounted on top. The template on the last page of this manual may be used to establish mounting hole locations.

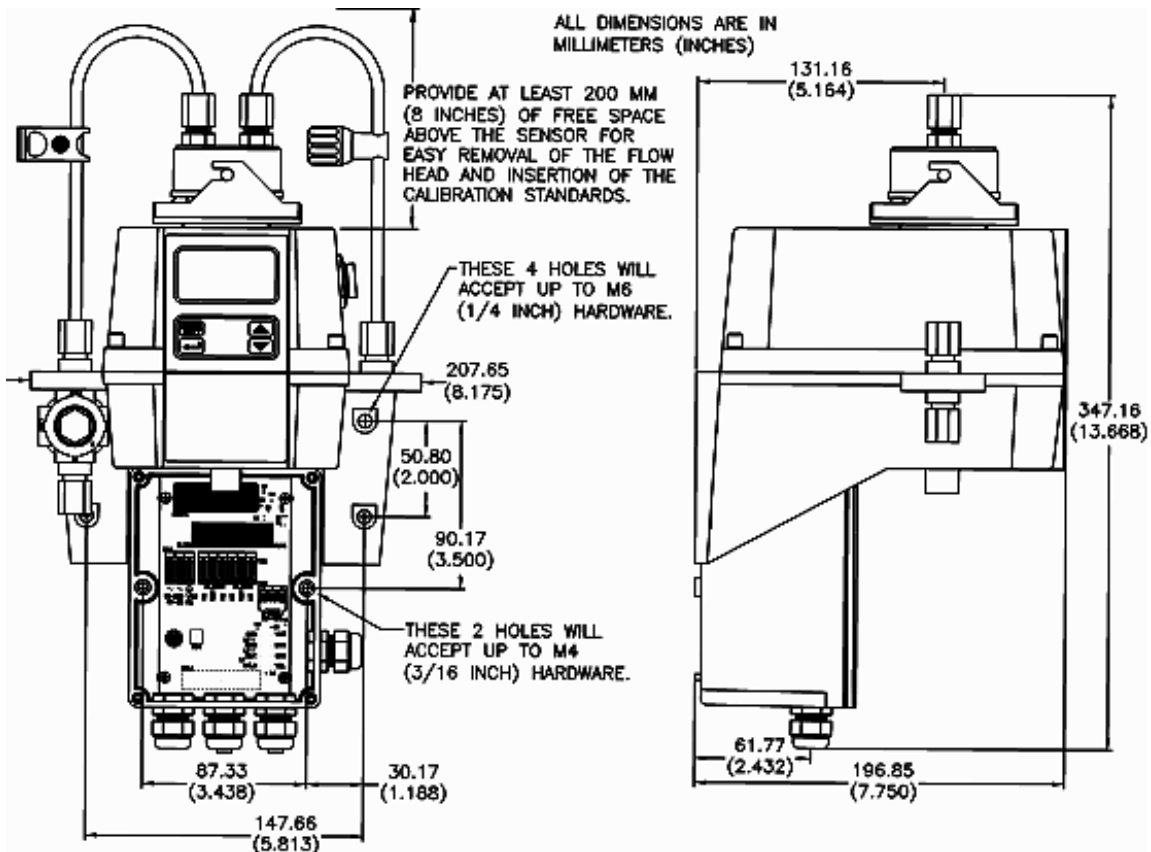

Figure 3 - Overall Mounting Dimensions of the Instrument

It is critical that the instrument be mounted as close as possible to the sampling point to ensure a quick response time (within 2-3 meters (6-10 ft) of the sampling point).

3.2. Plumbing

The recommended plumbing for the instrument is shown in Figure 4. The instrument is designed to require very little head pressure to operate; around 6.9kPa (1 PSI). The flow through cuvette is rated for a flow of 100ml/min. – 1 liter/min. (0.026-0.26Gal/min). The integral pressure regulator is rated for a maximum pressure of 1380 kPa (200 PSI.). The maximum allowable fluid temperature is 50°C (122°F).

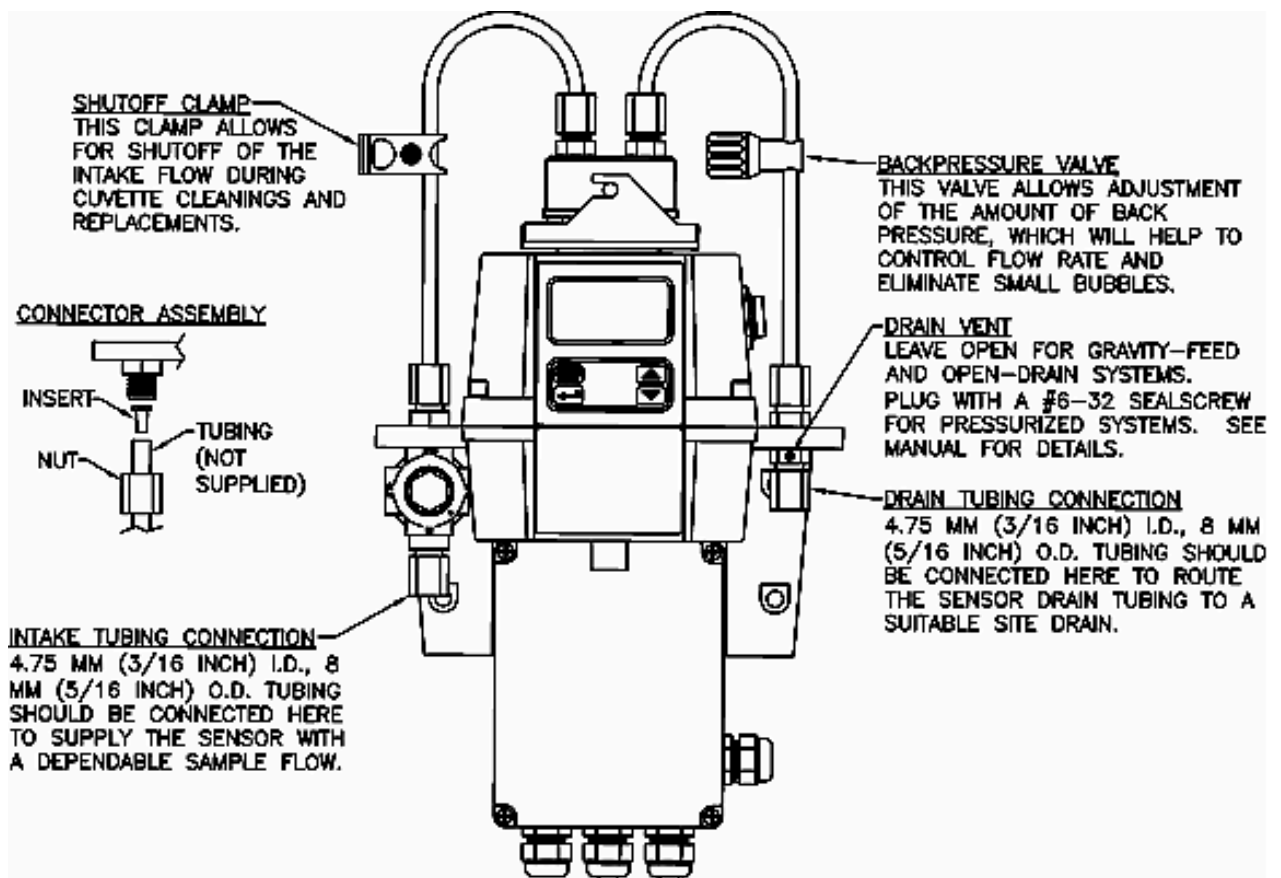

Figure 4 - Recommended Plumbing for the Instrument

The instrument is equipped to be plumbed using 4.75 mm (3/16") ID, 8 mm (5/16") OD flexible tubing. Opaque tubing should be used if the tubing will be exposed to sunlight, to prevent algae growth.

In figure 4, there are two flow devices shown. The one on the input side is a shutoff clamp used during cuvette maintenance. The other device is a backpressure valve. Backpressure may be required to prevent air from coming out of solution, which may be observed as tiny air bubbles.

3.2.1. Drain Vent:

The AM-TBR has been fitted with a drain vent in the "OUT" bulkhead fitting. This fitting allows for atmospheric equalization, thus helping to alleviate bubble formation in the cuvette. Refer to Figure 4.

Upon initial flow minor leakage may occur through the drain vent. This will subside once normal flow is established.

For some high pressure systems, where the vent hole continuously leaks, a 6:32 seal screw is provided which should be inserted into the vent hole and tightened.

The sensor drain tubing **MUST** be routed to a suitable drain. **DO NOT** reintroduce the drain sample to the process stream. This is due to the fact that the wetted materials are not FDA approved. See below for more information.

3.2.2. Wetted Materials:

Water Analytics accepts no responsibility for damage caused by the introduction of vapors, fluids or other materials into the instrument process stream which is not compatible with the instrument's wetted materials. A list of the wetted materials can be found in the specifications on page 1 of this manual.

3.3. Electrical Connections

All of the electrical connections to the instrument are made through the field terminal box, which should be located directly under the sensor portion of the instrument. The connections are labeled within the terminal box and are self-descriptive (see Figure 5). Please follow all local and government recommendations and methods for installation of electrical connections to and between the instrument and other peripheral devices.

Plugs are inserted into the alarm and 4-20mA/RS-485 cable bulkheads when shipped, to ensure a watertight seal. These plugs should be removed and discarded when cabling to either of these connections.

The power cable bulkhead will accept cable diameters from 5.8mm (.230 in.) up to 10 mm (.395 in.). All terminals are designed to accept wires in the range of 14-28 AWG. All wires should be stripped to a length of 6 mm ($\frac{1}{4}$ "). A strain relief strap is provided to reduce tension on the power terminals.

It is the user's responsibility to assure that the watertight seal is maintained after the terminal box has been wired for operation. If any of the bulkheads are not tightened properly around a cable or plug, the ratings of the instrument will be jeopardized and there is a possibility of creating a shock hazard.

Note: Only qualified electricians should be allowed to perform the installation of the instrument as it involves a line voltage that could endanger life.

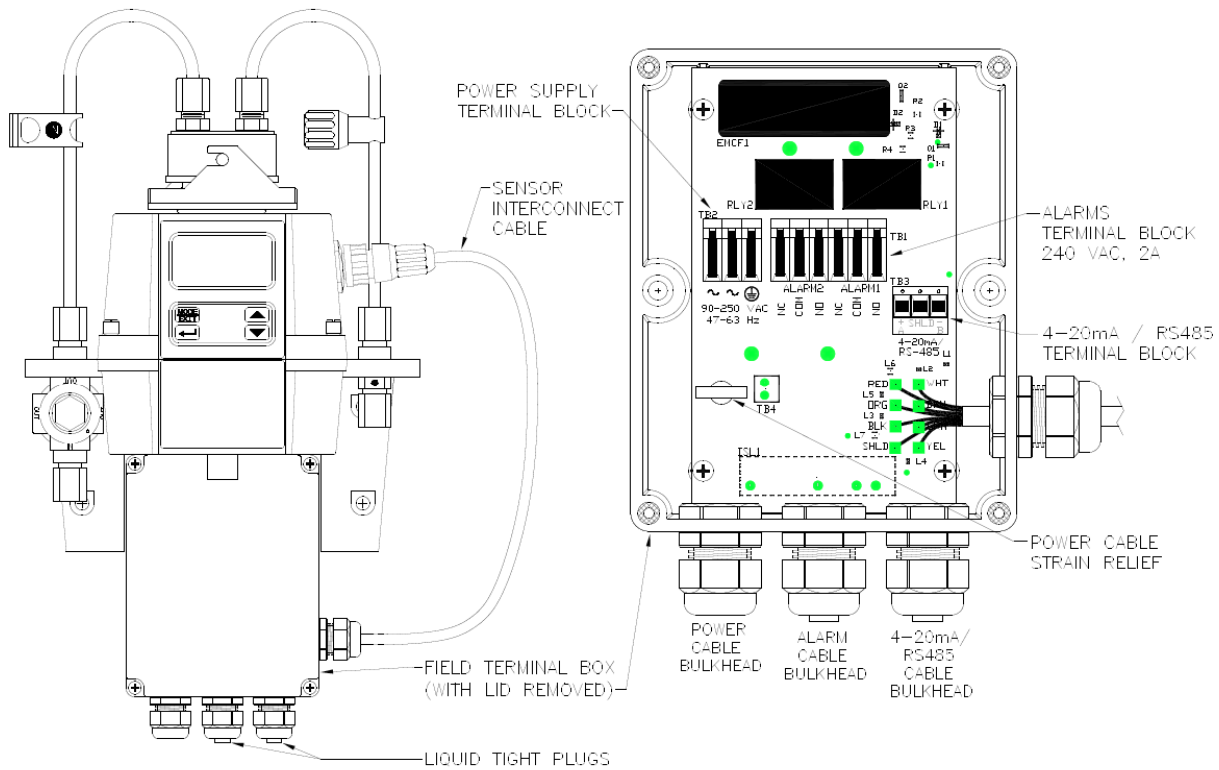

Figure 5 - Electrical Connections for the Instrument

3.3.1. Power

The instrument is equipped with a 100-240 VAC, 47-63 Hz switching power supply; please verify that the line voltage falls within these specifications. It is recommended that a circuit breaker be placed prior to the power connection to allow for service. While making connections, refer to Figure 5. **The AM-TBR is not supplied with a power cord.**

3.3.2. RS-485

The RS-485 half-duplex (2-wire) digital interface operates with differential levels that are not susceptible to electrical interferences. This is why cable lengths up to 3000 ft can be implemented. The last device on each bus may require terminating with a 120-ohm resistor to eliminate signal reflection on the line. Do not run RS-485 cables in the same conduit as power.

To prevent damage to the instrument, ensure that power is disconnected prior to making connections. For ease of connecting, remove the plug in terminal block. Connections are labeled beneath this termination.

3.3.3. Relays

The Alarm 1 and Alarm 2 relays are mechanical relays rated at 240 VAC 2A. Please note that the relays are labeled NO (Normally Open), NC (Normally Closed) and C (Common). As these alarms are configured fail-safe, the normal condition is with power applied to the AM-TBR and in a non-alarm condition. Operation of these alarms is covered in section 7.5 *Configuring the Alarms*.

3.3.4. 4-20 mA

The 4-20 mA output is driven by a 15 VDC power source and can drive recorder loads up to 600 ohms. This 4-20 mA output is isolated from line power and earth ground. Do not run 4-20 mA cables in the same conduit as power. Operation of this output is covered in section 7.2.

Note: The installation of the 4-20 mA isolator will render the RS-485 non-operational.

Ensure each instrument is not powered when connecting the 4-20 mA. To prevent damage to the instrument, ensure that power is disconnected prior to making connections. For ease of connecting, remove the plug in terminal block. Polarities of the connections are labeled beneath this termination.

4. Operation

This process turbidimeter allows for the measurement of the turbidity of process water on-line. The turbidity of the process water is usually reported in **Nephelometric Turbidity Units (NTU)**, but may be reported in **Formazin Nephelometric Units (FNU)**. Readings above 1000 NTU (100 for models AM-TBR3) are outside the range of this instrument. Readings above 1100 NTU (110 for models AM-TBR3) will cause the display to flash indicating an over range condition.

During normal operation, the instrument will have the arrow beside **AUTO** highlighted with the current scale displayed on the lower row of the display and the measured reading on the upper row of the display (see illustration below).



4.1. Routine Measurement

The following steps describe how to measure the turbidity of a sample using this instrument:

1. Apply power to the instrument and allow the unit to warm up (typically 45 minutes to 1 hour on initial commissioning).
2. When a continuous process stream is flowing through the instrument, the instrument will display the measured turbidity level of the sample by displaying it on the LCD screen. In addition, the equivalent signal is provided on the analog (4-20 mA) output, or the digital output, depending on the options selected.

4.2. Security Access Feature

The instrument is equipped with a security access code feature that can be activated in the configuration mode. If the security feature is enabled, the screen shown in the illustration below will appear when the **MODE/EXIT** button is pressed.

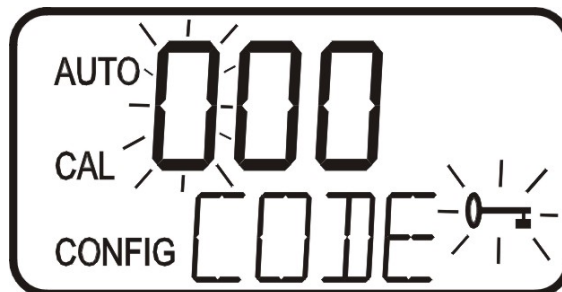

The security code (333) must be entered to gain access to **CAL** or **CONFIG** menus. Notice that the first number in the code is flashing; the flashing indicates that this is the number to be changed. Use the **□** **OR** **□** arrows to select the first of the three numbers in the code and then press the **↵** button to accept the first number of the code. Now enter the second number in the code. Proceed as with the first number followed by **↵**. Then repeat the process for the third number in the access code, and finish with the **↵** button.

If the valid access code has been selected, the instrument will be directed to the calibration mode. If the wrong access code is selected, the instrument will return to the **AUTO** mode. Refer to section 7.7 for more information.

5. Instrument Calibration

The instrument was calibrated and tested prior to leaving the factory. Therefore, it is possible to use the instrument directly out of the box. Under normal conditions, re-calibration is recommended at least once every three months¹.

Relay contacts will change to the alarm state while the instrument is in the calibration and/or in the configuration mode. While in the calibration mode, the instrument has a time-out feature that automatically returns the system operation to the AUTO mode after a fifteen (15) minute period of inactivity.

5.1. Calibration Standards

If the AM-TBR will be used over the entire range of .02 to 1000 NTU a complete calibration as described below will be required. If instrument accuracy is only required below 10 NTU, such as potable water, a calibration may be performed using only a 10 NTU and a 0.02 NTU standard. To calibrate starting at the 10 NTU, press the \square button to bypass the 1000 NTU and proceed to Section 5.2, step 5.

We recommend that the following materials be used during calibration to achieve the full-scale accuracy stated in this manual:

1. 0.02 NTU **TBR-Cal** Calibration Standard available from Water Analytics
2. 10.0 NTU **TBR-Cal** Calibration Standard available from Water Analytics
3. 1000 NTU **TBR-Cal** Calibration Standard available from Water Analytics

It is well known that diluted Formazin is unstable. If Formazin is used to calibrate the instrument, ensure that a fresh stock suspension of Formazin is used to achieve the accuracy quoted for the instrument. A Formazin Stock Solution Kit is available from Water Analytics (Catalog No. 50040). The Water Analytics **TBR-Cal**, primary calibration standards (refer to section) are more stable than Formazin and have a minimum shelf life of 12 months. Prior to recalibration, review the expiration dates, to ensure that the standards have not expired.

Note: The range of Models 20055 & 20056 is .02 to 100 NTU. For calibrating these models replace the 1000 NTU standard with a 100 NTU standard.

5.2. Calibration Procedures

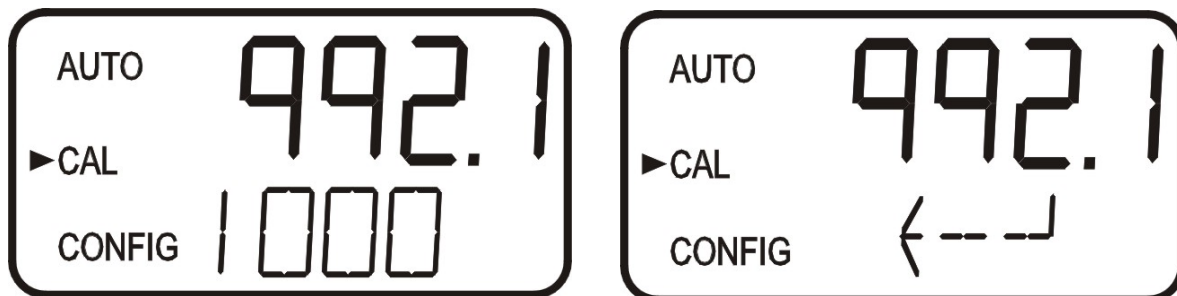

1. Select the calibration function of the instrument by pressing the **MODE/EXIT** button once.

¹ The EPA recommends that on-line turbidimeters be calibrated with a primary standard at least once every three months if they are to be used for EPA reporting.

The arrow beside **CAL** will be illuminated on the display. The lower display shows alternating **1000** (the value of the standard that is requested) and \downarrow . The upper display shows the real-time reading to allow the standard to be indexed. Refer to section 6.1 for information on indexing cuvettes.

2. Remove the flow through unit.
3. Insert the requested 1000 NTU standard. Index the standard to the lowest value on the upper display.
4. Press the \downarrow button to accept the calibration.
5. The lower display will count down the progress of the calibration step.
6. The lower display will now change to show alternating **10** and \downarrow , requesting the 10.0 NTU standard.

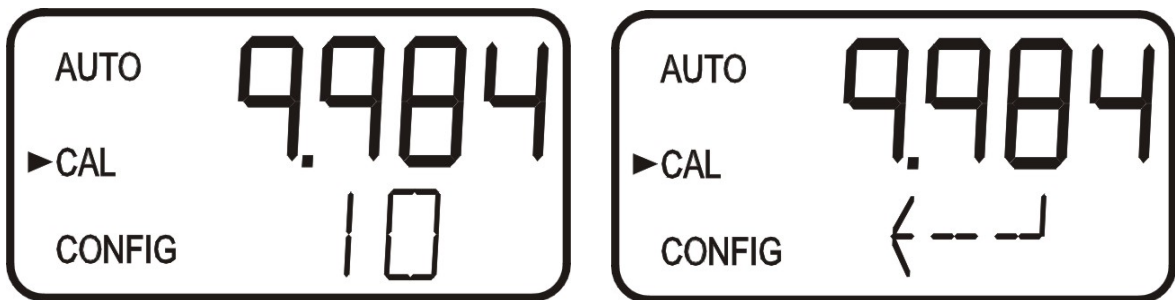

7. If the alternating **10** and \downarrow is not displayed, push the \square or \square until this display is shown.
8. Insert the requested 10.0 NTU standard. Index the standard to the lowest value on the upper display.
9. Press the \downarrow button to accept the calibration.
10. The lower display will count down the progress of the calibration step.
11. The lower display will now change to show **02** and \downarrow , requesting the 0.02 NTU standard.

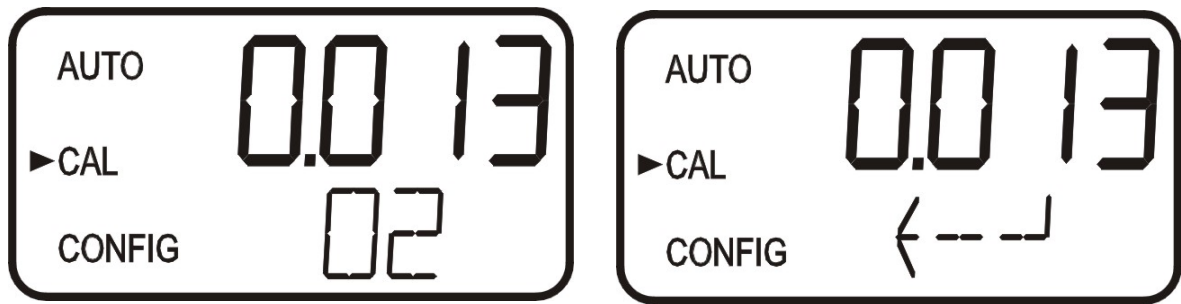

12. Insert the requested 0.02 NTU standard. Index the standard to the lowest value on the upper display.
13. Press the \downarrow button to accept the calibration.
14. The lower display will count down the progress of the calibration step.
15. The instrument will return to **AUTO** mode at the end the calibration.

Note: During calibration, the fan inside the instrument is turned off to extend the life of the desiccant. The fan will be turned on during calibration countdowns and after returning to the AUTO mode or after five minutes, which ever comes first. It is recommended that the measurement chamber be kept covered during the calibration period and that the flow through cuvette be replaced immediately after the calibration to prevent premature saturation of the desiccant.

5.3. Calibration Error

If the screen shown below, is displayed after calibration, the internal diagnostics have determined that the calibration standards were either bad or that they were inserted in the wrong order. Either check the standards and recalibrate or restore the factory calibration see 6.2. The instrument cannot be used without performing one of these operations.

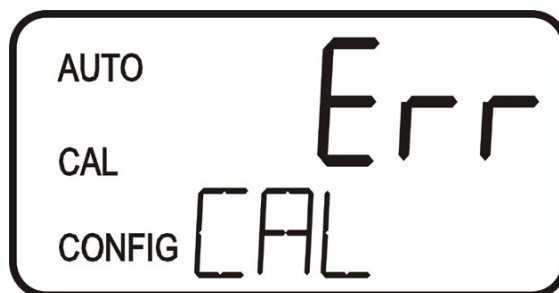

To recalibrate press the MODE key and start the calibration sequence again. To restore the factory calibration, push and hold the \square button. Now push and release the \downarrow then release the \square button.

6. Instrument Offset

In certain instances, it may be desirable to use an offset factor to calibrate the instrument rather than performing a physical calibration of the instrument (as described in section 5.2). This procedure is not recommended in lieu of regular instrument calibration but it can be used in situations where the number of instruments used makes regular calibration prohibitive. This calibration technique will make the instrument accurate **only** at turbidity levels in the immediate vicinity of the grab sample and **not** in the full range of the instrument. Note that the **OFFSET** icon will be illuminated whenever an offset used. The maximum offset is ± 1.00 NTU. If instrument variation is greater than 1 NTU a full calibration is recommended.

The procedures are as follows:

1. Collect a grab sample of the process water that is being monitored by the instrument and record the turbidity reported by the instrument.
2. Take the grab sample and measure its turbidity using a laboratory turbidimeter (contact the Water Analytics customer services department for examples of laboratory turbidimeters).
3. Compare the turbidity reported by the instrument to that obtained in the laboratory. If the readings are very close, then no offset adjustment or calibration is required and the procedure may be stopped at this step. However, if the readings are substantially different (but less than 1 NTU), continue on in this procedure to utilize the offset option to improve the turbidity reading of the instrument so that it will agree with the laboratory reading between calibrations.
4. Select the offset function of the instrument by pressing the **MODE/EXIT** button until the arrow beside **CONFIG** is illuminated on the display. Refer to the following screen.
5. Push the \leftarrow button until **OFST** is displayed on the lower row.
6. At this point, the lower row of the display will indicate the operational status of the offset function (**On** or **OFF**). Change this status by using the \square and \square buttons. Once the desired operational status of the offset function has been set, press the \leftarrow button to accept it. If the option was turned off, return to **AUTO** mode by pressing **MODE/EXIT**.

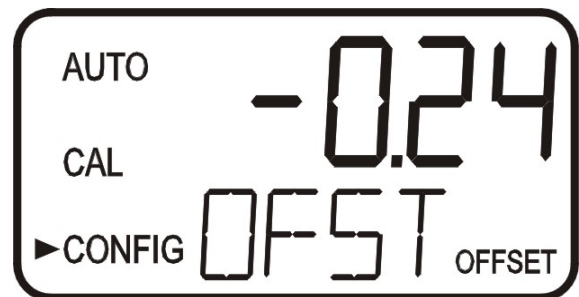

7. If the option was turned **On**, the upper row will display the offset required. This will add or subtract the value of the offset to the measured NTU value. As an example if the AM-TBR measures the process at 0.16 NTU but the laboratory instrument read the sample at 0.12 NTU, adding an offset of -0.04 would result in the AM-TBR displaying 0.12 NTU.
8. Select the desired offset level using the \square and \square buttons. Once the desired level has been set, press the \blacktriangledown button to accept it.
9. This completes the offset configuration.
10. At this point, the instrument will continue through the configuration (**CONFIG**) mode of the instrument or press **MODE/EXIT** to return to the **AUTO** mode.

6.1. Indexing Calibration Cuvettes

To achieve the greatest accuracy, and account for normal scratches and aberrations in cuvette glass when calibrating, Water Analytics recommends indexing the cuvettes.

Standards and standard kits purchased from Water Analytics are supplied with indexing rings.

The following steps allow repeatable indexing of calibration standards:

1. With the instrument in AUTO mode insert the standard.
2. Slowly rotate the standard, inside the optical well, one complete revolution (360°). While rotating the standard slowly, observe the measured turbidity and locate the position of the cuvette having the lowest reading.
3. With the calibration standard positioned at the location having the lowest turbidity reading, install the Indexing Ring over the cap on the standard so that the pointer of the Indexing Ring faces directly forward.

When using the standards in future, always insert the standard so that the pointer of the indexing ring faces forward. Slowly rotate the standard back and forth about 5° to find the lowest point. The standard is now indexed and ready for use.

6.2. Restoring Factory Settings

If the instrument is unable to perform a calibration due to a low lamp output or a calibration using the wrong standards, the instrument will display **CAL** on the lower row of the display and **Err** on the upper row. The operator has two choices to correct this problem. If the operator can determine whether a poor calibration or a low lamp caused the problem, he/she can remedy the problem and recalibrate. If all else fails, the operator may restore the factory calibration and configuration settings by performing the following operation. Push and hold the \square button. Now push and release the \blacktriangledown then release the \square button. Factory calibration and factory configuration have now been restored.

Note: Restoring the factory settings allows the use of the AM-TBR with reduced accuracy. The original problem still exists and must be determined and corrected before accurate operation of the AM-TBR will be resumed.

7. Instrument Configuration (CONFIG mode)

The instrument has been designed to provide the ability to customize the instrument according to needs at any time during normal operation. This mode has been split into sub-menus to facilitate instrument configuration. This section describes how to use each of the sub-menus to configure the instrument. While in the configuration mode, the instrument has a time-out feature that automatically returns the system operation to the **AUTO** mode after a fifteen (15) minute period.

Enter the **CONFIG** mode of the instrument by pressing the **MODE/EXIT** button until the arrow beside **CONFIG** is illuminated, then press the \downarrow button.

Note: To exit the CONFIG mode, press the MODE/EXIT button.

7.1. Selecting the Output (O/P)

The first configuration selection is the **O/P**. The selections are **4-20** for the 4-20 mA output, **485** for the RS-485 and **OFF** if no outputs are required. Select the desired output by using the \square and \square buttons. Once the desired output has been set, press the \downarrow button to accept it. The next prompts will depend on the output selected.

7.2. Setting the 4-20 mA

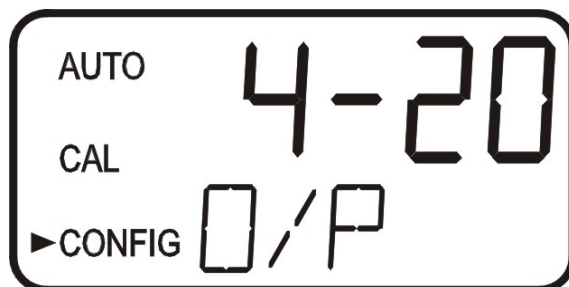

If the 4-20 mA output was turned on, prompts to set the 4mA (**4MA**) and 20mA (**20MA**) turbidity limits levels will be displayed. There is also a menu to adjust the error level (**ERLV**). The first prompt will be the turbidity limit assigned to the 4 mA output level:

Select the turbidity level to assign to the **4MA** using the \square and \square buttons.

The factory setting is 0.02 NTU.

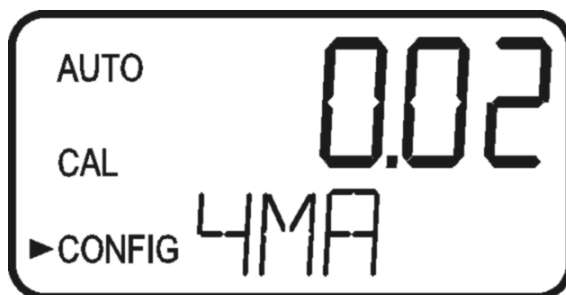

Once the desired level has been set, press the \downarrow button to accept it.

Note: The 4MA can be set higher than the 20 MA level to invert the output current if required. This may be required to control a dosing pump

The next, prompt will be the turbidity level assigned to the 20 mA output level (**20MA**) on the lower row of the LCD display). Select the turbidity level to assign to the **20MA** using the \square and \square buttons. Once the desired level has been set, press the \downarrow button to accept it.

The factory setting is 10.00 NTU.

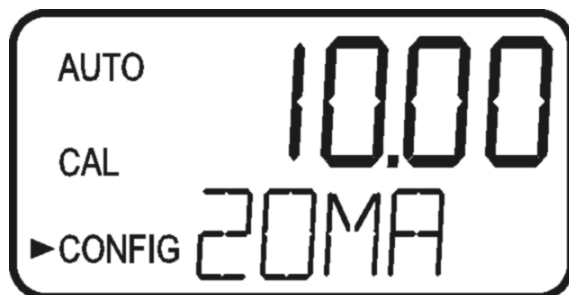

7.3. Configuring the Error Level

In case of an error in the AM-TBR, the 4-20 mA reading can be used to indicate a problem by sending the current to either 4.00 mA, 2.00 mA or 0 mA or OFF. In the case of OFF, the 4-20mA is unaffected by any error condition. The factory default setting is OFF. Select the desired ERLV by using the \blacktriangle and \blacktriangledown buttons then press the \leftarrow button to accept the desired error response.



7.4. Configuring the RS-485 Port

If the instrument is equipped with this option, and the I/O selection is changed to **485**, prompts will appear for setting the baud rate and the address.

Select the correct baud rate (1200, 2400, 4800, 9600, or 19200) for operation of the I/O port by pressing the \square or \square buttons to change the displayed baud rate.

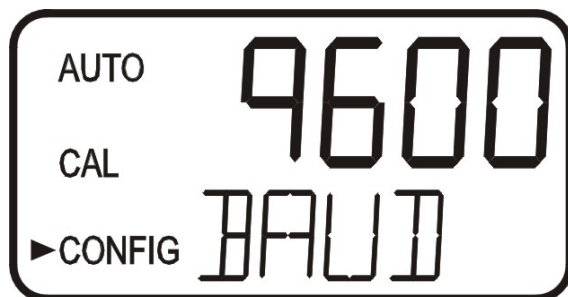

Press the \downarrow button to continue on and select the desired instrument address using the \square or \square buttons. Once the selection is satisfactory, press the \downarrow button.

Select the address using \square or \square buttons. Press the \downarrow button to save.



To enable the Modbus mode, select **ASCII** or **RTU**. For more information refer to a Modbus manual

7.5. Configuring the Alarms

Two relays are provided that are designed to operate as two independent programmable alarms. Three types of information must be input to fully program each alarm:

1. The alarm function (HI, LO, OFF or Error)
2. The alarm set point (level at which the alarm activates)
3. The delay time for the alarm: the time that the set point must be exceeded prior to alarm activation and the time before resetting the alarm (prevents chatter in the relay)

These three items are described below:

Alarm Function: The alarms can either be turned OFF or programmed to operate in one of three different manners:

1. HI alarm: the relay changes state when the measured turbidity level is higher than the programmed alarm level for a prescribed amount of time.
2. LO alarm: the relay changes state when the measured turbidity level is lower than the programmed alarm level for a prescribed amount of time.
3. Error: the relay changes state when a system error occurs. If a system error occurs a message will appear on the lower row of the screen describing the problem.

Alarm Set Point: The level at which an alarm activates is called the alarm set point. On the instrument, the alarm set point is designated as "S/P". The set point is adjustable to any valid turbidity level over the range of the instrument in steps of 0.01 NTU.

Alarm Delay Time: The alarm delay times are used to prevent ringing of the alarm when the measured turbidity level is close to the set point. The function of the delay times is as follows:

Delay On: The turbidity level must exceed the alarm set point continuously for at least this

number of seconds before the alarm activates.

If the delay on time is set at 5 seconds and the process turbidity exceeds the set point continuously for only 4 seconds, the alarm will not be activated. However, process turbidity exceeds the set point continuously for 5 seconds or more, the instrument will activate the alarm.

Delay Off: The turbidity level must not exceed the alarm set point continuously for at least this number of seconds prior to deactivation of the alarm.

If the delay off time is set to 5 seconds and the process has exited out of the alarm condition, the alarm will be reset only if the process is out of the alarm condition for a continuous 5 seconds. Otherwise, the instrument will still signal an alarm condition.

7.5.1. Alarm 1

Alarm 1 Function: The **ALM1** is displayed and the display indicates the current function of alarm 1 (**HI, LO, OFF** or **Error**). Use the or buttons to cycle through and select the desired function. Press the button to accept the selection.

If the alarm was turned **OFF** a prompt will appear to set up alarm 2 (go to section 7.5.2). If, on the other hand, one of the other functionalities was selected a prompt will appear to set the delay times.

Alarm 1 Set Point: This prompt is used to select the set point for this alarm; this is indicated by "S/P" shown on the lower row of the display. Select the desired alarm level by using the and buttons. Once the desired set point has been set, press the button to accept it.

Alarm 1 Delay Times: *Delay On:* The following display will appear to allow to select the number of seconds currently set for the "delay on" time.

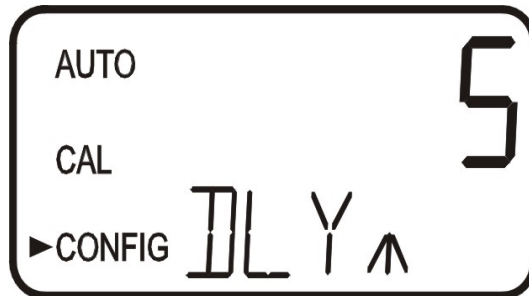

The current selected number of seconds will be shown. Select the desired number of seconds for the "delay on" time for this alarm using the and buttons. Once the desired delay time has been set, press the button to accept it.

Delay Off: Next, the following display will appear to select the number of seconds currently set for the "delay off" time.

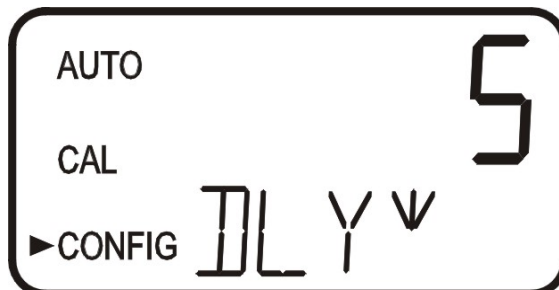

The current selected number of seconds will be shown. Select the desired delay off time for this alarm using the \square and \square buttons. Once the desired delay time has been set, press the \downarrow button to accept it. After the settings for alarm 1 have been completed, prompts will allow for the set up of the information on alarm #2.

7.5.2. Alarm 2

Repeat the procedure listed in section 7.5.1 to set up the parameters for alarm 2. If one of the other functionalities is selected, a prompt to set the delay times and the set point, as with Alarm #1, will be displayed.

7.6. Offset Calibration

Refer to section 6 for more information on this selection.

7.7. Enabling the Security Access

The instrument is equipped with a security access. If this option is turned on, the user is required to input the access code into the instrument to get to any mode other than **AUTO**. The only code is **333**. This code may not be changed. See section 4.2 for more information on this security feature. The security key icon will be visible and flashing on the display whenever the access option is selected using the \square or \square buttons. (**On** or **OFF**).

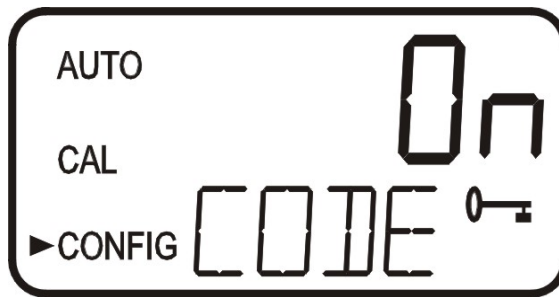

7.8. Extended Settings

The last few settings are grouped together to prevent them from being adjusted by accident. To gain access to the extended settings, select **On** using the \square or \square buttons and press the \downarrow button.

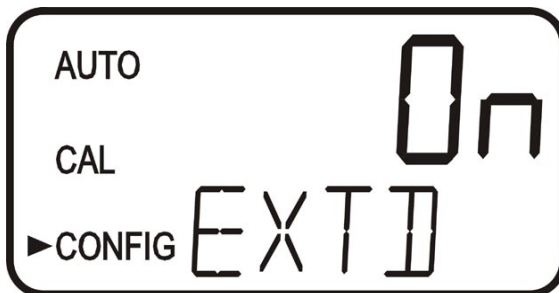

7.9. Speed of Response

The speed of response for both displayed and output values of NTU can be adjusted in this menu. The default setting is 10, however 100 response speeds are available. Although the displayed number is a relative speed, the approximate response time, in seconds, is the displayed number multiplied by 5. Select the desired speed of response using the \square and \square

buttons. Press the \downarrow button to accept it.

To avoid reading air and other anomalies, select the slowest speed (highest number). Select the fastest response where monitoring of rapid changes is needed.



7.10. Displayed Resolution

The instrument is equipped with the ability to display several levels of resolution. The instrument can display up to four digits to the right of the decimal place for turbidity readings below 10 NTU. The default setting is 0.01 NTU. If the last digit or two is not stable, adjust the resolution to hide these digits.

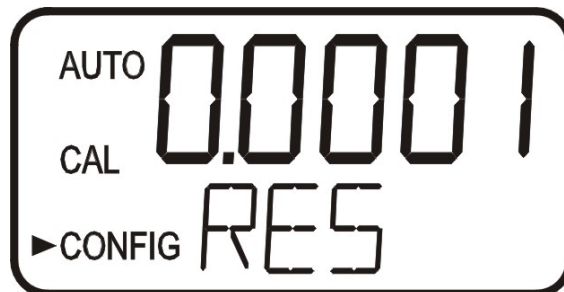

Change the resolution by pressing the \square or \square button. When the desired digit resolution has been selected, press the \downarrow button.

7.11. LCD Backlight Brightness

The LCD backlight brightness may need to be adjusted. This is of particular interest if multiple instruments are located in the same area and it is desired for the entire group to have the same appearance. Ten levels are available. The default brightness is 8.



Change the brightness by pressing the or button. When the desired brightness has been selected, press the button.

7.12. Setting the Units

The most common unit is **NTU** (Nephelometric Turbidity Units) however the instrument can display in **FNU** (Formazin Nephelometric Units). All instruments are shipped from the factory set in NTU mode. Make a selection using the and buttons then press the button.

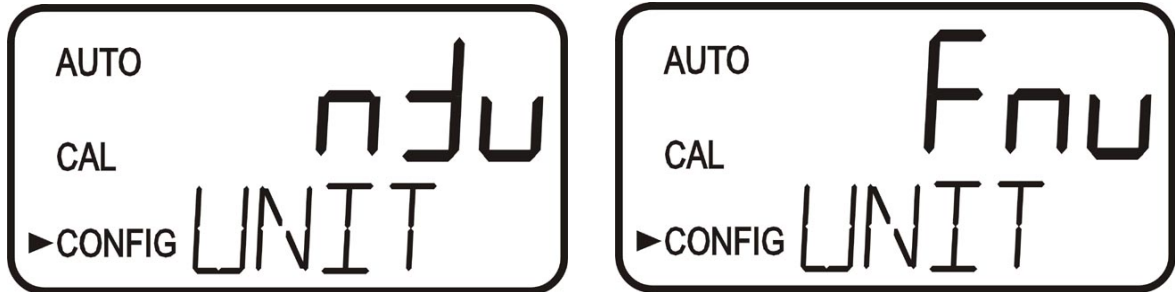

7.13. Ultrasonic Cleaning

This allows for a selection menu to turn off the ultrasonic cleaning function if desired. The default mode is On. Make a selection using the and buttons then press the button.



7.14. RS-485 Parameters

For instruments manufactured on or after June 2003, the following menus can be used to modify the RS-485 parameters. These menus will only appear if the RS-485 is enabled (see section 7.1). The default is 8 Bit, no (nOnE) Parity, 1 Stop Bit. Make selections using the and buttons then press the button to move to the next menu.

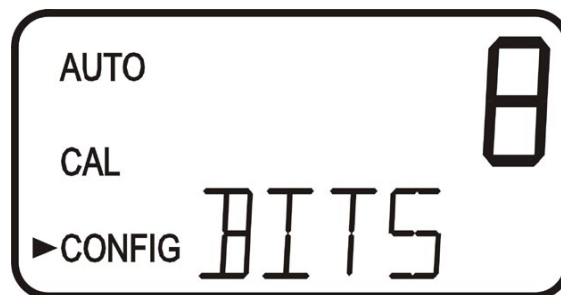



7.15. Desiccant Alarm

When the humidity detector in the AM-TBR indicates that the internal environment is close to the point where humidity could cause condensation, the instrument will display **DESC** as a screen warning.

If desired, a desiccant warning can:

1. Activate the alarms relays.
2. Can activate an alarm condition on the 4-20mA.

To activate the alarm relays when the desiccant fails, select set one or both alarms to Error (see section 7.5).

To activate an alarm condition on the 4-20 mA set the ERLV to one of the three alarm states (see section 7.3)

For either alarm modes to activate **On** must be selected in the **DESC** menu. The default for this menu is **OFF**. Make selections using the and buttons then press the button to move to 4-20 mA calibration.

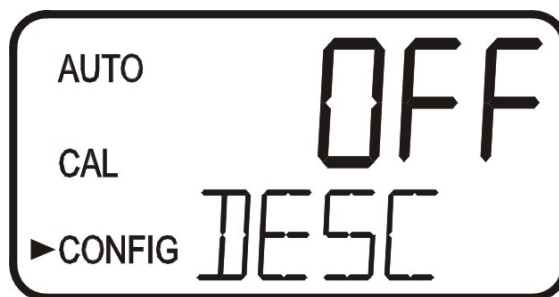

7.16. 4mA Adjustment

If the 4-20 mA setting is turned ON (see section 7.2), the following two menus will appear. The first menu outputs a constant 4 mA while allowing for a small amount of adjustment. The adjustment can be made using the ▲ and ▼ buttons. This adjustment will allow the operator to make the AM-TBR agree with a PLC or SCADA system. The adjustment limits are ± 200 counts or about ± 0.2 mA.

This setting will be slightly different on each instrument as each AM-TBR will be factory set to 4.00mA. Press the ↵ button when adjustments are complete to save this setting and move on to the 20mA adjustment.

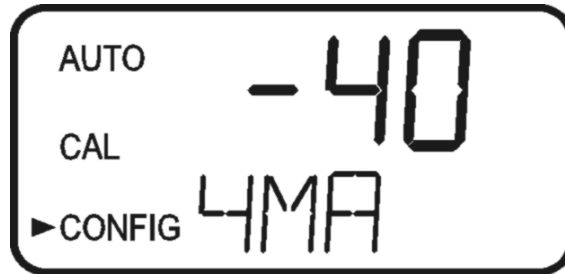

7.17. 20mA Adjustment

This menu operates similar to the previous menu. This menu outputs a constant 20 mA while allowing for a small amount of adjustment. The adjustment can be made using the ▲ and ▼ buttons. The adjustment limits are ± 1000 counts or about ± 1 mA.

This setting will be slightly different on each instrument as each AM-TBR will be factory set to 20.00mA.



7.18. Saving Configuration Settings

If extended settings are set to **OFF**, pressing the ↵ button will save all settings and the AM-TBR will automatically return to the normal **AUTO** mode of the instrument.

If extended settings are set to **On**, after the last menu of the extended settings, pressing the ↵ button will save all settings and the AM-TBR will automatically return to the normal **AUTO** mode of the instrument.

The **CONFIG** menu may be used at any time to reset or change any of the parameters. The **CONFIG** menu may be exited at any point in the menu by using the **MODE/EXIT** key. Any features that have been modified will be saved.

8. Additional Features and Options

8.1. Backlit LCD

The backlit LCD allows for easier readability of the LCD display in low light or no light conditions. The backlight is intended for continuous operation. The brightness is adjustable from a menu in the **CONFIG** mode.

8.2. Ultrasonic Cleaning

This factory installed option is used to continuously clean the flow through cuvette. It is not intended to clean cuvettes that are already dirty, or replace manual cleaning entirely. The system will increase the time between cleanings dramatically. Please note that the system requires the use of a special cuvette. This cuvette must be used for the system to operate correctly.

The system works by sending an ultrasonic frequency through spring connections into a piezo transducer bonded to the bottom of a flow through cuvette (refer to figure 6).

The system can detect that an incorrect cuvette is installed, an error has occurred in the transducer or the transducer is not making contact with the spring connections. This error is indicated by **CLN** being posted to the lower screen. Since this is an error condition, this may affect the 4-20 mA and alarms depending in the setting of the ERLV (4-20 mA) and if an alarm is set up to Error.

If the correct cuvette is installed, and the error is still posted, try rotating the flow through unit slightly to improve the connection. If this fails to work, the cuvette may have to be replaced (Catalog #24166S). The detection for this cuvette only operates in **AUTO** mode. If the system is operating correctly **AUTO** will flash on the display.

Hint: The connection can be improved with use of a small film of an anti-oxidant compound such as OX-GARD™ made by GB Electrical Inc. This product is available in the electrical section at most hardware stores.

Note: The cuvette must be completely dry before it is inserted into the sensor. If there is any visible moisture present on the cuvette or transducer, there is a great risk of damaging the sensor electronics and the transducer. Be sure to clean and dry the cuvette completely just before inserting it into the sensor.

The Vapor Purge system can NOT remove large droplets of water, only residual moisture.

Note: For the Vapor Purge system to function properly, all instrument seals must be maintained and the desiccant pack must be in good condition (no DESC display).

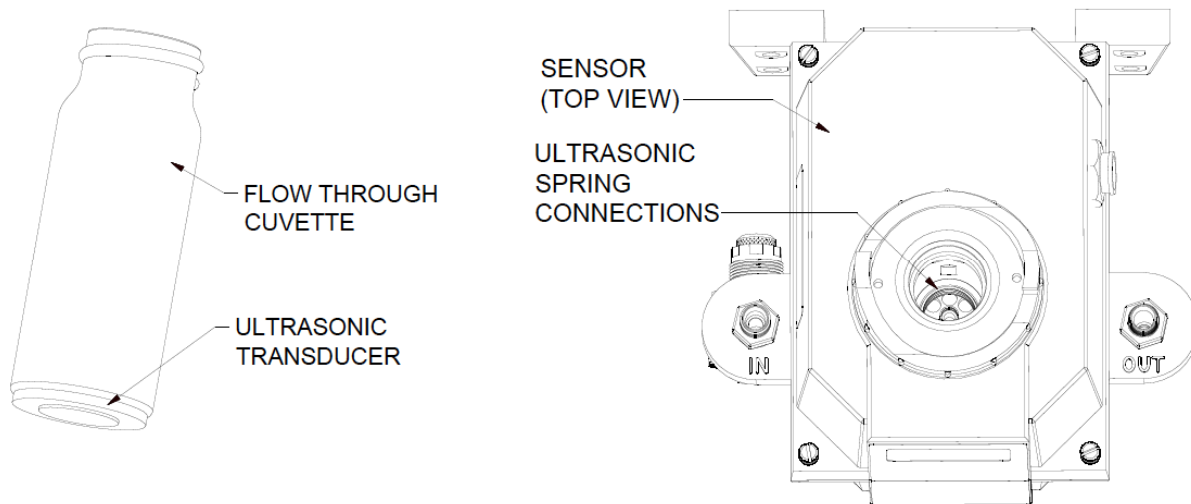

Figure 6 - Operational parts of the Ultrasonic Cleaning System

8.3. RS-485 Outputs

The AM-TBR has the capability to operate in three different RS-485 modes for all models. Included is a mode for interfacing into the online software package (section below), and a simple communication mode. A third operating mode is the Modbus communications. All modes will automatically configure and do not require any changes or selections.

8.3.1. Water Analytics Online (WA catalog # 19783)

The AM-TBR can operate as a small SCADA system with an optional PC software package, called WA ONLINE. This system allows for an interface with up to 255 AM-TBR's for the purpose of data logging. This system will interface directly with common database and spreadsheet software.

8.3.2. Simple Communication

The AM-TBR can provide basic communications over simple programs such as the Hilgraeve HyperTerminal that is included with most Microsoft Windows packages. The user could also use Visual Basic or other programs. The default communication parameters are 8 bits, no parity and 1 stop bit. These can be changed in the Extended **CONFIG** menus (see section 7.14).

The master computer will send out:

1. Byte #1 the attention character ":" in ASCII or **3A** Hex
2. Byte #2 the address of the AM-TBR being queried
3. Byte #3 & 4 CR LF or 0D 0A in hex

The AM-TBR will respond with:

1. The same attention character ":" in ASCII or **3A** Hex
2. The address of the AM-TBR
3. The Reading
4. The Unit (NTU)

A sample communication would look like this:

(Master computer requesting a report from address #1): **1 CRLF**

(AM-TBR set to address #1 Response):**001 0.0249 NTU**

8.3.3. Modbus Communication

Modbus protocol communication is operational on all models. The Modbus information is covered in a separate manual.

8.4. Flow Alarm (Catalog # 19945A)

The flow switch for the AM-TBR is a factory-installed option. This option indicates a “Low Flow” condition by switching both relays to the fail state and setting the 4-20 mA signal to 2 mA. There is also a screen indication of the low flow condition and a modbus register is set.

8.5. Flow Controller (Catalog # 19778)

The flow controller limits the flow, in high-pressure systems, to safe flow limits of less than 1 liter/minute.

8.6. Remote Panel Meter (Catalog # 19609)

The remote panel meter allows for remote indication of the NTU reading using the 4-20 mA loop. No external power is required as the meter is run off of the 4-20 mA source.

9. Troubleshooting & Maintenance

9.1. AM-TBR Fault Detection

The AM-TBR performs continuous diagnostic monitoring. In the AM-TBR there are three levels of fault detection; warnings, errors and failures. Any faults are displayed in a queue form in the bottom row of the LCD. How these faults are indicated depends on the settings made in sections 7.3 and 7.5. If ERLV is set to OFF and Alarms are not set to Error, there will be no remote, indication of a problem.

If the desiccant alarm is turned off and the desiccant becomes saturated only a screen **warning** of **DESC** will appear and no alarms are activated. Another **warning** of **ALM1** or **ALM2** is displayed if an alarm is set and the threshold is exceeded.

An **error** indicates a failure or a problem that usually can be corrected by the operator. These errors consist of:

1. Lamp out **LAMP**.
2. 4-20 mA loop open **MA**.
3. Bad calibration **CAL**.
4. If desiccant alarm activated and replacement required **DESC**.
5. If enabled and no flow **FLOW** (if equipped with the flow switch).
6. If the AM-TBR is equipped with ultrasonic cleaning, an additional message will indicate that the ultrasonic transducer is not making contact or the flow through has been removed **CLN**.

If any of these errors occur the instrument will still display readings, however the accuracy is not known and the instruments readings may not be reliable.

A **failure** is a system fault. This is NOT a problem that the operator can correct, and the unit must be returned to the factory for service. These failures consist of failures in the CPU, A/D, EEPROM or other devices internal to the instrument (**FAIL**). If a failure occurs, the instrument will not function properly and will display the word FAIL on the lower row.

If any fault conditions occur, the message indicating the fault will be shown on the lower row of the display.

9.2. System FAIL Message

Normally, this condition indicates that the instrument will require servicing. Contact either the Water Analytics Technical Service Department or the Water Analytics Customer Service Department.

Water Analytics, Inc.
100 School St. Andover, MA 01810
Phone: 978-749-9949 or Toll Free 855-pH-Probe
Fax: 978-749-9961
Email: Info@wateranalytics.net
www.aquamatrix.com

9.3. Diagnostic Chart

| Symptom | Cause | Cure |
|--|---|---|
| Lower display shows MA | 4-20 mA loop open | Check wiring. See sections 3.3.4 and 7.2 |
| Lower display shows DESC | Desiccant pouch bad | Change desiccant pouch. See section 10.2 |
| Lower display shows LAMP | Lamp failed | Replace lamp. Refer to section 10.3 |
| Lower display shows FLOW | Sample flow has stopped | Restore flow. Contact WA about factory installed option |
| Lower display shows FAIL | Major system fault | Refer to section 9.1 & 9.2 |
| Readings are higher than expected | Bubbles in solution Condensate or leaky cuvette Flow through cuvette dirty Instrument out of calibration | (1) Ensure that the drain vent is open and is not obstructed. See section 3.3.2 (2) Apply backpressure. See section 3.2 and Figure 4 (3) For sever cases of bubbles a stilling chamber is available. Call Water Analytics. Part# 20106 Check flow through cuvette for condensate or leaks. Clean cuvette. See section 10.1 Recalibrate. Refer to section 5 |
| Readings are erratic | (1) Bubbles in solution (2) Debris in flow through | (1) See above (2) Clean debris from cuvette |
| Readings are lower than expected | Instrument out of calibration | Recalibrate. Refer to section 5 |
| Upper display flashes | Sample Over-Range | Check sample. Sample may be too high to read. |

9.4. Technical and Customer Assistance

If for any reason assistance is needed regarding this instrument please do not hesitate to contact either the Water Analytics Technical Service Department or the Water Analytics Customer Service Department:
Water Analytics, Inc.

100 School St. Andover, MA 01810
Phone: 978-749-9949 or Toll Free 855-pH-Probe
Fax: 978-749-9961
Email: Info@wateranalytics.net
www.aquamatrix.com

10. Routine Maintenance

10.1. Cleaning the Flow Through Cuvette

Measurement cuvettes used for both grab sample and the flow through should be clean and free of marks or scratches. Cleaning is accomplished by cleaning the interior and exterior with a detergent solution and then rinsing several times with distilled or de-ionized water. The cuvette can be replaced by first shutting off the flow using the provided shutoff clamp; unscrewing the old cuvette and replacing with a fresh clean one.

10.2. Replacing or Installing the Desiccant Pouch

The AM-TBR continuously checks the condition of the desiccant. When the desiccant gets in such a condition that it may cause problems, the instrument will display **DESC** on the lower portion of the display to indicate the presence of humidity. See section 7.15.

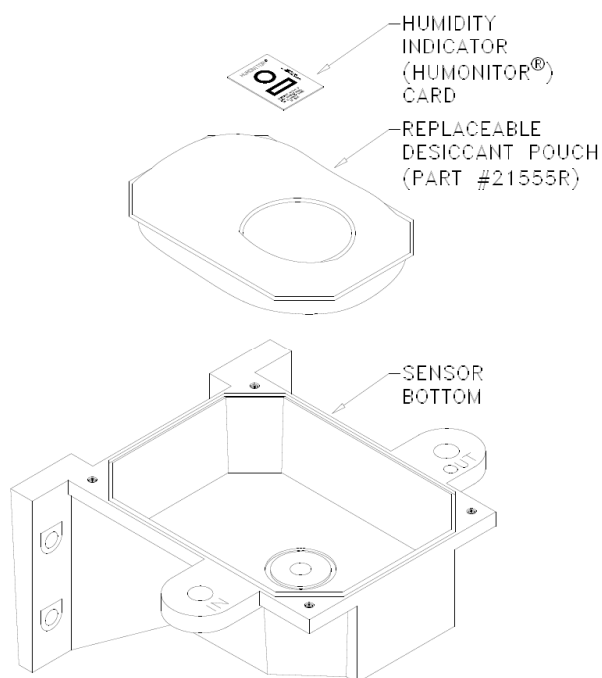

Figure 7 Replacing the Dessicant Pouch

Proper use of the supplied desiccant is essential in maintaining the performance of the instrument. The desiccant has been designed to have a long life; however, replacement of the desiccant pouch will be required from time to time.

It is essential that the enclosure seal on the instrument base be maintained to ensure adequate desiccant life. Inspect the seal each time the desiccant pouch is replaced. Replace or reseal the seal if it is found to be defective.

The desiccant should be replaced when the instrument displays DESC. A new sealed desiccant pouch and indicator card are available from Water Analytics part #21555R. To initially install or remove the old desiccant, simply unscrew the four corner thumbscrews and remove the electronics half of the instrument. Open the bag protecting the new desiccant pouch and replace (or install for a new instrument) in the instrument base assembly. To speed up the recognition, by

the instrument, of the new desiccant it will be necessary to reset the instrument by disconnecting the sensor interconnect cable for 2 seconds and then reconnecting it.

Note: Once the bag is opened, install the desiccant pouch immediately to prevent premature degradation of the desiccant.

10.3. Replacing the Source Lamp

The source lamps in the AM-TBR's are designed for long life. The IR lamp is rated for 10 years and the white light version is rated for 7 years. If the lamp should need replacement, we recommend calling WA Service Department for assistance.

11. Accessories and Replacement Parts List

The items shown below are recommended accessories and replacement parts.

| Accessory | Catalog Number | |
|---|----------------|----------|
| | White Light | Infrared |
| Electronic Service Module For AM-TBR 2 | 02053 | 02054 |
| Electronic Service Module For AM-TBR 3 | 02055 | 02056 |
| Electronic Service Module For AM-TBR 4 | 02063 | 02064 |
| Operating Manual, AM-TBR | 24034 | |
| ProCal Calibration Kit, .02, 10 & 100 NTU | 39953 | |
| ProCal Calibration Kit, Full Range, .02, 10 & 1000 NTU | 39957 | |
| Formazin Stock Kit | 50040 | |
| Formazin Stock Solution, 4000 NTU, 500 ml | 70914 | |
| Replacement Desiccant Pouch | 21555R | |
| Software for data collection and reporting | 19783 | |
| Flow Regulator, AM-TBR | 19778 | |
| Pressure Regulator | 24306S | |
| Replacement Cuvette – MicroTOL 2 (3 pack) | 50036 | |
| Replacement Cuvette with Ultrasonic Transducer | 24166S | |
| Tubing Kit Containing: 1-shutoff clamp, 1-backpressure valve, 2-connecting tubing with fittings for flow through assembly, drain vent. | 21062 | |

To order any accessory or replacement part, please contact the Water Analytics Customer Service Department. If for any reason technical assistance is needed regarding this instrument please do not hesitate to contact the WA Technical Services Department.

Water Analytics, Inc.
 100 School St. Andover, MA 01810
 Phone: 978-749-9949 or Toll Free 855-pH-Probe
 Fax: 978-749-9961
 Email: Info@wateranalytics.net
www.aquamatrix.com

12. Warranty

Water Analytics Inc., as vendor, warrants to the original purchaser of this instrument that it will be free of defects in material and workmanship, in normal use and service, for a period of one year from date of delivery to the original purchaser. Water Analytics Inc.'s obligation under this warranty is limited to replacing, at its factory, the instrument or any part thereof. Parts, which by their nature are normally required to be replaced periodically, consistent with normal maintenance, specifically reagent, desiccant, sensors, electrodes and fuses are excluded. Also excluded are accessories and supply type items.

Original purchaser is responsible for return of the instruments, or parts thereof, to Water Analytics' Inc.'s factory. This includes all freight charges incurred in shipping to and from Water Analytics Inc.'s factory.

Water Analytics inc .is not responsible for damage to the instrument, or parts thereof, resulting from misuse, environmental corrosion, negligence or accident, or defects resulting from repairs, alterations or installation made by any person or company not authorized by Water Analytics Inc.

Water Analytics Inc. assumes no liability for consequential damage of any kind, and the original purchaser, by placement of any order for the instrument, or parts thereof, shall be deemed liable for any and all damages incurred by the use or misuse of the instruments, or parts thereof, by the purchaser, its employees, or others, following receipt thereof.

Carefully inspect this product for shipping damage, if damaged, immediately notify the shipping company and arrange an on-site inspection. Water Analytics inc cannot be responsible for damage in shipment and cannot assist with claims without an on-site inspection of the damage.

This warranty is given expressly and in lieu of all other warranties, expressed or implied. Purchaser agrees that there is no warranty on merchantability and that there are no other warranties, expressed or implied. No agent is authorized to assume for Water Analytics Inc., any liability except as set forth above.

Water Analytics, Inc.
100 School St.
Andover, MA 01810
Phone: 978-749-9949 or Toll Free 855-pH-Probe
Fax: 978-749-9961
Email: Info@wateranalytics.net
www.aquametrix

1.

MOUNTING TEMPLATE

ALL DIMENSIONS ARE IN MILLIMETERS (INCHES)

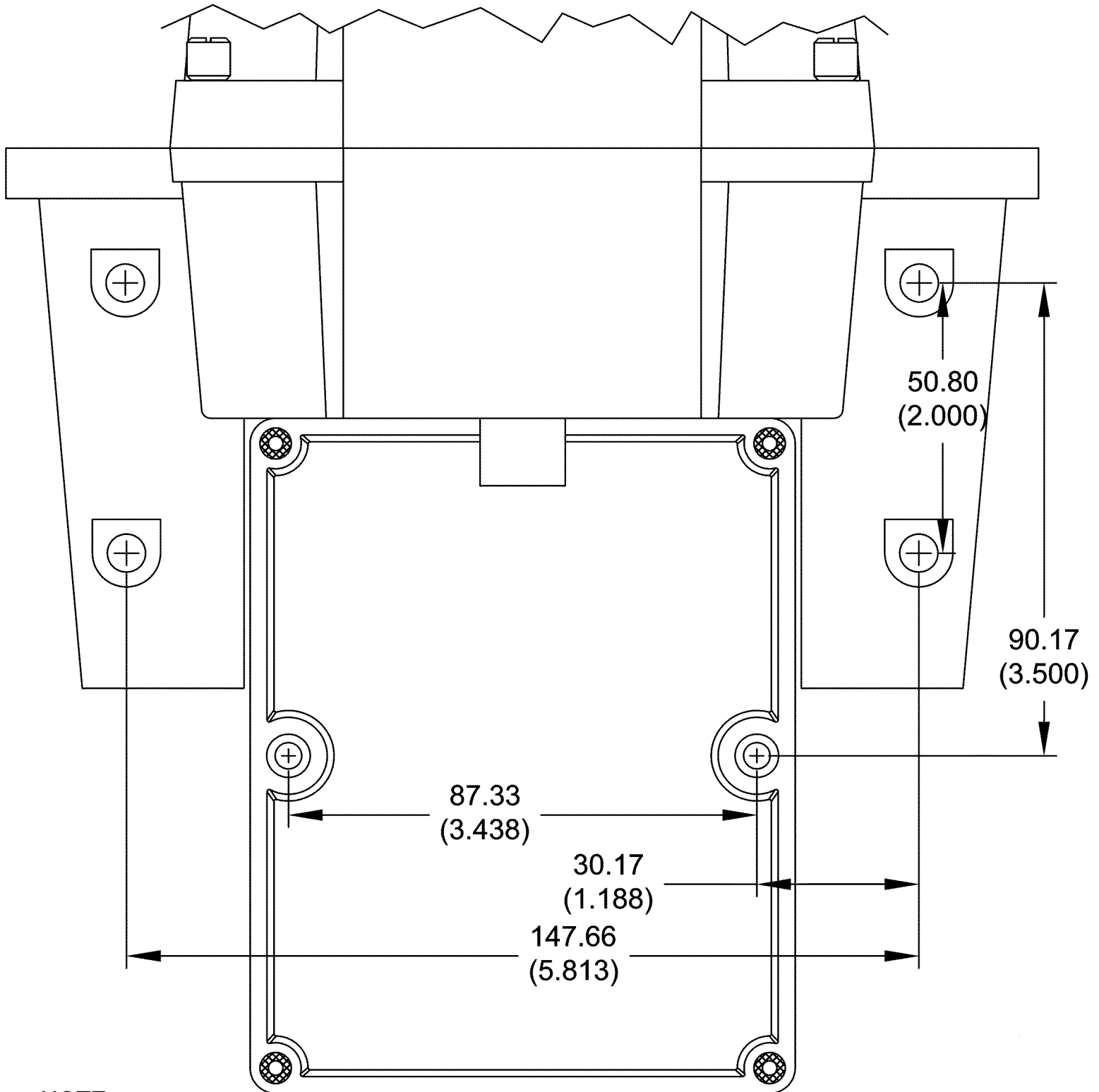

NOTE:

- 1) SEE THE MOUNTING INSTRUCTIONS IN THE MANUAL FOR MOUNTING HARDWARE SIZES.
- 2) PROVIDE AT LEAST 200 MM (8 INCHES) OF FREE SPACE ABOVE THE SENSOR FOR EASY REMOVAL OF THE FLOW HEAD AND INSERTION OF THE CALIBRATION STANDARDS.

1.