



Transit-Time Ultrasonic Flowmeter

Model AUF750 Series

Operation Manual



Index

1. Introduction- - - - -	4
1.1 Preface - - - - -	4
1.2 Features - - - - -	4
1.3 Principle of Measurement - - - - -	4
1.4 Applications- - - - -	5
1.5 Packing List (standard) - - - - -	5
1.6 Figures and Wiring Diagram - - - - -	6
2. Starting Installation and Measurement - - - - -	7
2.1 Inspection prior to Installation - - - - -	7
2.2 Power supply- - - - -	7
2.3 Powering on - - - - -	7
2.4 Keypad Functions - - - - -	7
2.5 Keypad Operation- - - - -	7
2.6 Window Descriptions- - - - -	8
2.7 Pipe Parameter Entry Shortcuts - - - - -	8
2.8 Transducer Wiring- - - - -	9
2.9 Installing the transducers - - - - -	9
2.10 Transducer spacing- - - - -	9
2.11 Transducer Mounting Methods - - - - -	9
2.12 V Method- - - - -	9
2.13 Z Method- - - - -	10
2.14 N Method (not commonly used) - - - - -	10
2.15 W Method (very rarely used)- - - - -	10
2.16 Transducer Mounting Inspection- - - - -	11
2.17 Signal Strength - - - - -	11
2.18 Total Time and Delta Time - - - - -	11
2.19 Transit Time Ratio- - - - -	11
2.20 Install Question - - - - -	11
3. Operating Instructions- - - - -	12
3.1 System Normal Identification- - - - -	12
3.2 Measurement Units Options - - - - -	12
3.3 Flow Rate Units Options - - - - -	12
3.4 Totalizer Units Options - - - - -	12
3.5 Totalizer Multiplier Options - - - - -	12
3.6 On/off Net Totalizer- - - - -	12
3.7 Totalizer Reset - - - - -	12
3.8 Factory Default Recovery - - - - -	12
3.9 Damping - - - - -	12

3.10 Low Flow Cutoff- - - - -	13
3.11 Zero Set Calibration - - - - -	13
3.12 Scale Factor - - - - -	13
3.13 System Lock (Unlock) - - - - -	13
3.14 4~20mA Current Loop Verification - - - - -	14
3.15 Frequency Output - - - - -	14
3.16 Totalizer Pulse Output- - - - -	14
3.17 Alarm Programming - - - - -	14
3.18 OCT Output- - - - -	15
3.19 Relay Output- - - - -	15
3.20 Date and Time Settings- - - - -	15
3.21 LCD Backlit Options - - - - -	15
3.22 Daily, Monthly, Yearly Totalized Flow - - - - -	15
3.23 Automatic Flow Correction - - - - -	15
3.24 Working Timer- - - - -	15
3.25 Batch Controller- - - - -	15
3.26 Analog Output Calibration- - - - -	16
3.27 Software Version and ESN - - - - -	16
4. Windows Display Explanations- - - - -	17
4.1 Windows Display Codes - - - - -	17
4.2 Display explanation- - - - -	18
5. Error Diagnoses - - - - -	30
6. Frequently Asked Questions and Answers- - - - -	32

1. Introduction

1.1 Preface

Welcome to the AUF750 series ultrasonic flow meter that has been manufactured with the newest technologies and is equipped with more functions and advanced performance than our previous versions. The AUF750 Series flow meter incorporates the latest ICs manufactured from the famous semiconductor manufacturers like Philips, TI, Winbond, and Xilinx. The hardware features the ease of operation, high accuracy and outstanding reliability, while the software provides a very user friendly interface and much more functions. It employs a patent balanced lower voltage multi-pulse igniting circuit which increases the anti-interference ability magnificently so that the flow meter will work properly even in demanding industrial environments such as those with power frequency transverter working nearby. Other outstanding features:
 ---the signal receiving circuits feature self-adapting performance so as to ensure that the user can easily operate the instrument without any adjustment.

1.2 Features

With distinctive features such as high precision, high reliability and high capability, AUF-750 features other advantages:

- *0.5% of linearity , 0.2% of repeatability
- *Daily, monthly and yearly totalized flow(5 years)
- *Self-Contained signal output, Including relay, open collector, 4~20 mA
- *U.S., British and Metric measurement units are available.
- *Power on/off function(64 times as power switched on/off)
- *Low Power consumption, hith reliability, anti-jamming.
- *Built-in data-logger
- *Frequency/Pulse output

1.3 Principle of Measurement

When the ultrasonic signal is transmitted through the flowing liquid, there will be a difference between the upstream and downstream transit time (travel time or time of flight), which is proportional to flow velocity, according to the formula below.

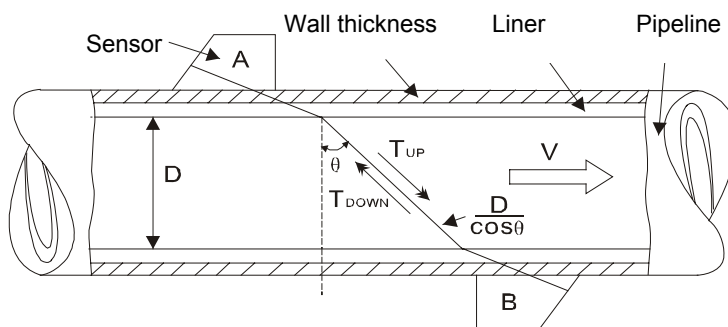

Photo 1.3.1

$$T_{UP} = \frac{M \times D / \cos \theta}{C_0 + V \sin \theta} \dots\dots\dots (1)$$

$$T_{DOWN} = \frac{M \times D / \cos \theta}{C_0 - V \sin \theta} \dots\dots\dots (2)$$

$$\Delta T = T_{DOWN} - T_{UP} \dots\dots\dots(3)$$

as(1), (2) and(3)Formula,you can get Velocity:

$$V = \frac{M \times D}{\sin 2\theta} \times \frac{\Delta T}{T_{UP} \times T_{DOWN}} \dots\dots\dots (4)$$

- Remarks: M -- Transit time of the ultrasonic signal
 D -- Pipe Inside Diamete
 θ -- The angle between the ultrasonic signal and the flow
 C_0 -- No liquid movement the Fluid Sound Velocity
 V -- Fluid Velocity
 T_{up} -- Transit time in the forward direction
 T_{down} -- Transit time in the reverse direction
 ΔT -- T_{up} – T_{down}

1.4 Applications

1. Water, sewage (with low particle content) and seawater
2. Water supply and drainage water
3. Power plants (nuclear power plant, thermal and hydropower plants)
4. Heat energy, boiler feed water and energy management system
5. Metallurgy and mining applications
6. Petroleum and chemicals
7. Food, beverage and pharmaceutical
8. Marine operation and maintenance
9. Energy economy supervision and water conservation management
10. Pulp and paper
11. Pipeline leak detection
12. Regular inspection, tracking and collection
13. Energy measuring and balance
14. Network monitoring systems and energy/flow computer management

1.5 Packing List (standard)

- | | |
|---------------------------------|----------|
| 1. Transmitter (AUF750) | 1 Set |
| 2. Standard transducer (sensor) | 1 Pair |
| 3. Operation Manual | 1 Copy |
| 4. Transducer strap | 1 Pieces |
| 5. Sonic coupling compound | 1 Piece |

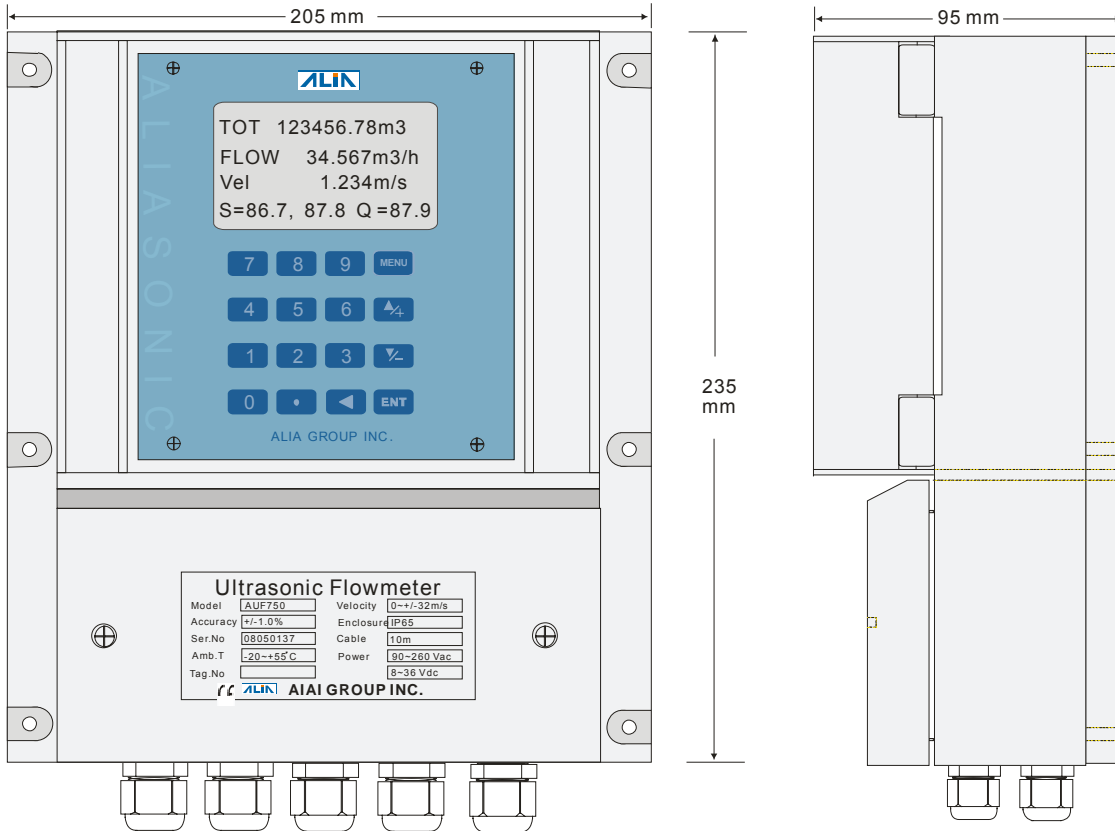

Photo 1.6.1

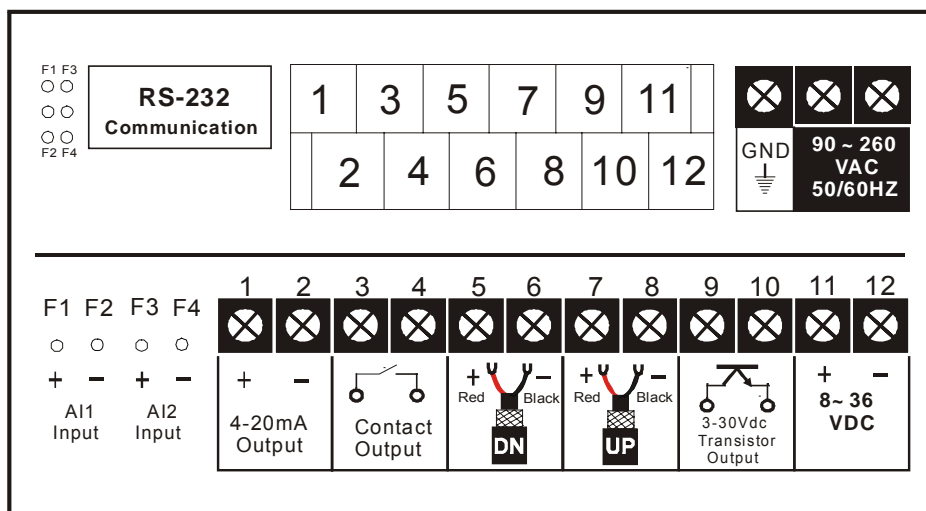

Photo 1.6.2

2. Starting Installation and Measurement

2.1 Inspection prior to Installation

Inspection should be made before installing the AUF-750. Check to see if the spare parts are in accordance with the packing list. Make sure that there is no potential damage to the enclosure due to a loose screw or loose wire, which occurred during transportation. Any questions, please contact your representative as soon as possible.

2.2 Power supply

90-260Vac, 50/60 Hz or 8-36 VDC.

2.3 Powering on

As soon as AUF-750 flowmeter is switched on, the self-diagnosis program will start to run. If any error is detected, a corresponding error code will display on the screen (Refer to Chapter of Error Diagnoses). After that, the system will run automatically according to the last input parameters. If the installation is accomplished when system is switched on, gain adjustment can be monitored in Window M01. After S1, S2, S3, S4 are displayed on the upper left corner of the screen, the system will activate the normal measurement condition automatically. It is indicated by code “*R” on the upper left corner of the screen. The system will default to the last window settings and automatically display then at every next power on.

2.4 Keypad Functions

Follow these guidelines when using the AUF-750 flowmeter keypad (Refer to Keypad Figure on the right-hand side of this page):

~ and to input numbers.

to backspace or delete characters to the left.

and to return to the last menu or to open the next menu. Also acts as “+” and “-” functions when entering numbers.

to select a menu. Press this key first, input two menu numbers and then enter the selected menu. For instance, to input a pipe outside diameter, press , where “11” is the window ID to display the parameter for pipe outside diameter.



2.5 Keypad Operation

With all of the parameters entered, the instrument setup and measurement displays are subdivided or consolidated into more than 100 independent windows. The operator can input parameters, modify settings or display measurement results by “visiting” a specific window. These windows are arranged by 2-digit serial numbers (including “+” sign) from 00~99, then to +0, +1, etc. Each window serial number, or so-called window ID code, has a defined meaning. For instance, Window M11 indicates the parameter input for pipe outside diameter, while Window F25 indicates the mounting distance between the transducers, etc.

The keypad shortcut to visit a specific window is to press the key at any time, then input the 2-digit window ID code. For instance, to input or check the pipe outside diameter, just press the keys for window ID code 11.

Another method to visit a particular window is to press , and keys to scroll the screen. For instance, if the current window ID code is F66, press key to enter Window M65, press the button again to enter Window M64; then, press the key to back Window M65, and press the key again to enter M66.

Example 1, To enter a pipe outside diameter of 1224, the procedure is as follows:

Press keys to enter Window M11 (the numerical value displayed currently is a previous value). Now press key. The symbol “>” and the flashing cursor are displayed at the left end of the second line on the Screen. The new value can be entered then...

.

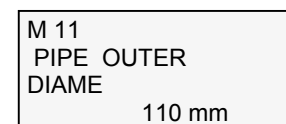

Example 2. If the pipe material is “Stainless Steel”, press keys to enter Window M14 first. Then press key to modify the options. Now, select the “1. Stainless Steel” option by pressing and keys, and then press key to confirm the selection. It is possible to press the key to change the selection and wait until “1. Stainless Steel” is displayed on the second line of the screen. Then press the key to confirm.

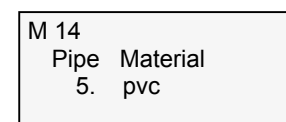

Generally, press **ENT** key first if operator wants to enter “modify” condition.

If the “modify” is still not possible even after pressing the **ENT** key,

it means that system is locked by a password. To “Unlock” it,

select “Unlock” in Window M47 and enter the original password. The keypad will not respond if the

keypad is locked. It only can be unlocked by entering original password. Select keypad lock functions in

Window M47.

2.6 Window Descriptions

AUF750 has the unique feature of windows processing for all operations.

These windows are assigned as follows:

00~09 Flow Totalizer Display: to display flow rate, positive total, negative total, net total, velocity, date & time, analog inputs for present flow, present operation and flow results today, etc.

10~29 Initial Parameter Setup: to enter pipe outside diameter, pipe wall thickness, fluid type, transducer type, transducer mounting and spacing, etc.

30~38 Flow Units Options: to select the flow unit, totalizer unit, measurement unit, turn totalizers on/off and reset totalizes, etc.

40~49 Setup options: Scaling factor, zero adjustment, network IDN (M46, system lock (M47),

50~69 Calibration: Include printer function, RS-232 communication, 4-20 mA output, flow Bacth controller, date and time, etc.

70~79 Alarm output function.

80~89 Energy measuring setting.

90~94 Diagnoses: Signal strength and signal quality (M90), TOM/TOS*100 (M91), flow sound velocity (M92), total time and delta time (M93), Reynolds number and factor (M94), etc.

+0~+7 Appendix: power on/off time, total working hours, on/off times and a single-accuracy function calculator.

For further information, please refer to Chapter of Operating Instructions and Chapter of Windows Display Explanations.

2.7 Pipe Parameter Entry Shortcuts

The following parameters should be entered for normal measurement:

1. Pipe outside diameter
2. Pipe wall thickness
3. Pipe material
4. Liner material parameters (including thickness and sound velocity, if needed)
5. Fluid type
6. Transducer type (The transmitter is available for various transducer types)
7. Transducer mounting methods

In the order stated above, enter the above-mentioned parameters by the following keypad shortcuts:

1. Press **MENU** **1** **1** keys to enter Window M11, and enter the pipe outside diameter, and then press the **ENT** key.
2. Press the **▼/–** key to enter Window M12, pipe wall thickness, and press the **ENT** key.
3. Press the **▼/–** key to enter Window M14, press the **ENT** key, move the **▲/+** or **▼/–** key to select pipe material, and press the **ENT** key.
4. Press the **▼/–** key to enter Window M16, press the **ENT** key, move the **▲/+** or **▼/–** key to select liner material, and press the **ENT** key.
5. Press the **▼/–** key to enter Window M20, press the **ENT** key, move the **▲/+** or **▼/–** key to select fluid type, press the **ENT** key.
6. Press the **▼/–** key to enter Window M23, press the **ENT** key, move the **▲/+** or **▼/–** key to select transducer type, and press the **ENT** key.
7. Press the **▼/–** key to enter Window M24, press the **ENT** key, move the **▲/+** or **▼/–** key to select transducer-mounting method, and press the **ENT** key.
8. Press the **▼/–** key to enter Window M25, accurately install the transducer according to the displayed transducer mounting spacing and the selected mounting method (Refer to *Installing the Transducers* in this chapter).
9. Press the **MENU** **0** **1** keys to enter Window M01 to display measurement result.

2.8 Transducer Wiring

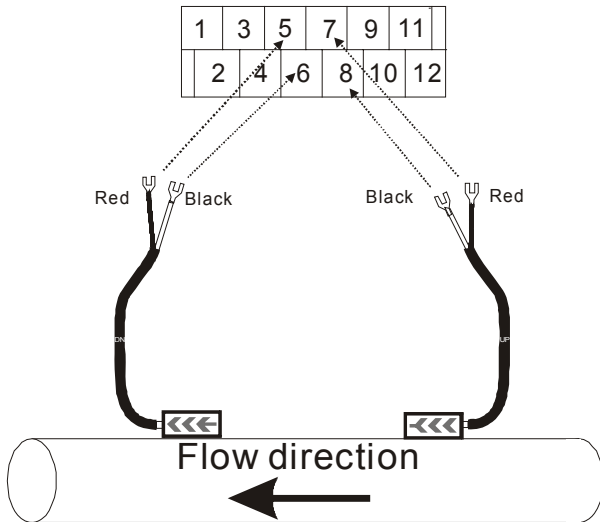

Photo 2.8.1

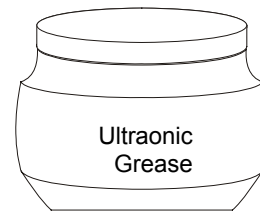

Photo 2.8.2

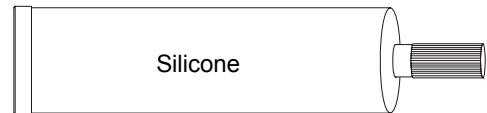

Photo 2.8.3

Sensor Installation

1. Please clear the outside of the pipe.
2. Apply the Ultrasonic Grease on the sensor average, make sure there have no any air between sensor & pipe.
3. Use Steel Mounting Belt hold the sensor, make sure the sensor position are fixed.
4. Apply the silicone around, the silicone will be solid status after few hours and make sensor position more stable.
Next step install sensor2.
5. Follow the step of sensor to install sensor2, make sure $M91=100\pm 3$, and the value are fixed, use mounting belt fix the sensor, make sure the sensor position are fixed.
6. The final step, use bandages tiding the cable on the pipe make sure the cable will not make the sensor moved.

2.9 Installing the transducers

Before installing the transducers, clean the pipe surface where the transducers are to be mounted. Remove any rust, scale or loose paint and make a smooth surface. Choose a section of sound conducting pipe for installing the transducers. Apply a wide band of sonic coupling compound down the center of the face of each transducer as well as on the pipe surface, and then attach the transducers to the pipe with the straps provided and tighten them securely. During the installation, there should be no air bubbles or particles between the transducer and the pipe wall. If the transducers cannot be mounted horizontally symmetrically due to limitation of the local installation conditions, it may be necessary to mount the transducers at a location where there is a guarantee full pipe condition (the pipe is always full of liquid).

2.10 Transducer spacing

After entering the required parameters, the spacing between the ENDS of the two transducers is considered as the standard transducer spacing. Check the data displayed in Window M25 and space the transducers accordingly.

2.11 Transducer Mounting Methods

Four transducer-mounting methods are available. They are respectively: V method, Z method, N method and W method. The V method is primarily used on small diameter pipes (DN100~300mm). The Z method is used in applications where the V method cannot work due to poor signal or no signal detected. In addition, the Z method generally works better on larger diameter pipes (over DN300mm) or cast iron pipes.

The N method is an uncommonly used method as well as is the W method. They are used on smaller diameter pipes (below DN50mm).

2.12 V Method

The V method is considered as the standard method. It usually gives a more accurate reading and is used on pipe diameters ranging from 25mm to 400mm approximately. Also, it is convenient to use, but still requires proper installation of the transducer, contact on the pipe at the pipe's centerline and equal spacing on either side of the centerline.

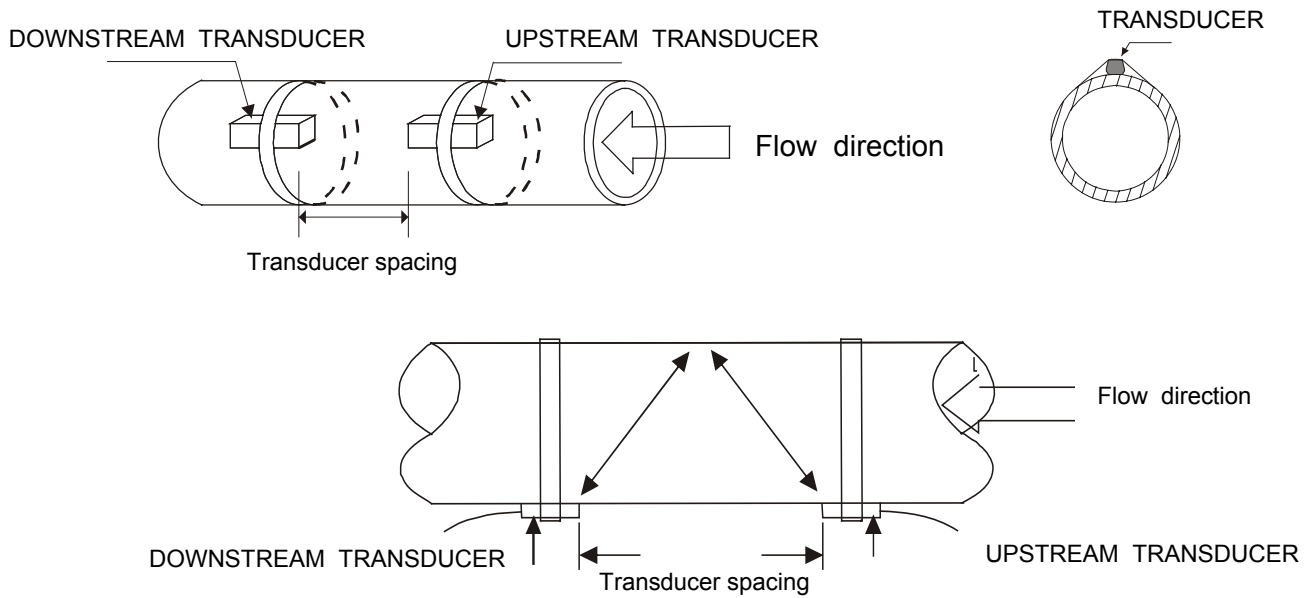

Photo 2.12.1 V Method

2.13 Z Method

The signal transmitted in a Z method installation has less attenuation than a signal transmitted with the V method. This is because the Z method utilizes a directly transmitted (rather than reflected) signal which transverse the liquid only once.

The Z method is able to measure on pipe diameters ranging from 100 to 3000mm approximately. Therefore, we recommend the Z method for pipe diameters over 300mm.

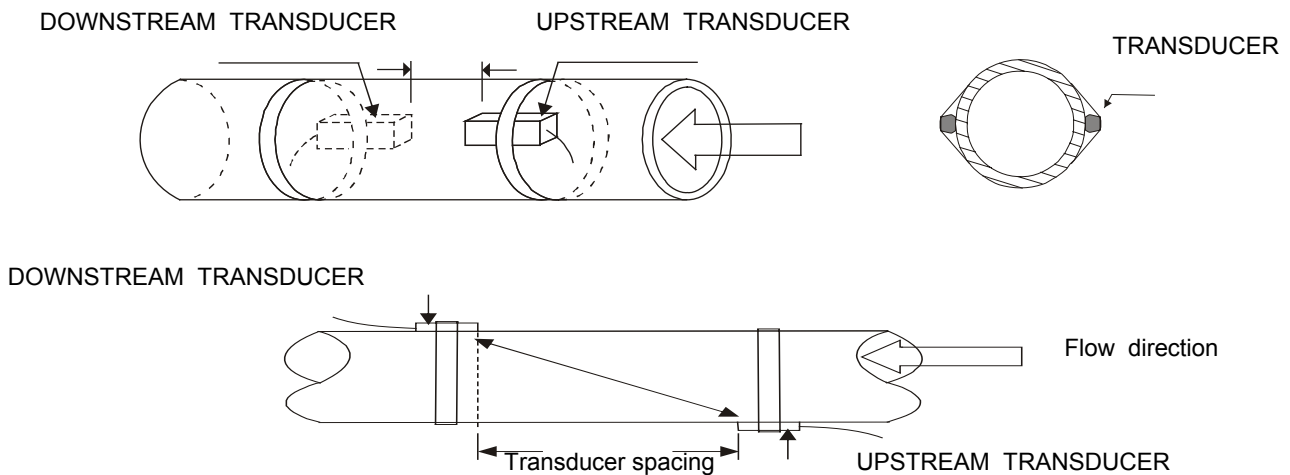

Photo 2.13.1 Z Method

2.14 N Method (not commonly used)

With the N method, the sound waves traverse the fluid twice and bounces three times off the pipe walls. It is suitable for small pipe diameter measurement. (uncommonly used).

The measurement accuracy can be improved by extending the transit distance with the N method.

2.15 W Method (very rarely used)

As with the N method, the measurement accuracy can also be improved by extending the transit distance with the W method. The sound wave traverses the fluid four times and bounces three times off the pipe walls. It is suitable for very small pipe (diameters less than 50mm).

2.16 Transducer Mounting Inspection

Check to see if the transducer is installed properly and if there is an accurate and strong enough ultrasonic signal to ensure proper operation and high reliability of the transducer. It can be confirmed by checking the detected signal strength, total transit time, delta time as well as transit time ratio.

The “mounting” condition directly influences the flow value accuracy and system long-time running reliability. In most instances, only apply a wide bead of sonic coupling compound lengthwise on the face of the transducer and stick it to the outside pipe wall to get good measurement results. However, the following inspections still need to be carried out in order to ensure the high reliability of the measurement and long-term operation of the instrument.

2.17 Signal Strength

Signal strength (displayed in Window M90) indicates a detected strength of the signal both from upstream and downstream directions. The relevant signal strength is indicated by numbers from 00.0~99.9 in the AUF-750 00.0 represents no signal detected while 99.9 represents maximum signal strength.

Normally, the stronger the signal strength detected, the longer the operation of the instrument reliably, as well as the more stable the measurement value obtained.

Adjust the transducer to the best position and check to ensure that enough sonic coupling compound is applied adequately during installation in order to obtain the maximum signal strength.

System normally requires signal strength over 60.0, which is detected from both upstream and downstream directions. If the signal strength detected is too low, the transducer installation position and the transducer mounting spacing should be re-adjusted and the pipe should be re-inspected.

2.18 Total Time and Delta Time

“Total Time and Delta Time”, which displays in Window M93, indicates the condition of the installation.

The measurement calculations in the flowmeter are based upon these two parameters. Therefore, when “DeltaTime” fluctuates widely, the flow and velocities fluctuate accordingly. This means that the signal quality detected is too poor. It may be the resulted of poor pipe-installation conditions, inadequate transducer installation or incorrect parameter input.

Generally, “Delta Time” fluctuation should be less than $\pm 20\%$. Only when the pipe diameter is too small or velocity is too low can the fluctuation be wider.

2.19 Transit Time Ratio

Transit Time Ratio indicates if the transducer mounting spacing is accurate. The normal transit time ratio should be 100 ± 3 if the installation is proper. Check it in Window M91.

If the transit time ratio is over 100 ± 3 , it is necessary to check

(1) if the parameters (pipe outside diameter, wall thickness, pipe material, liner, etc.) have been entered correctly, (2) if the transducer mounting spacing is accordance with the display in Window M25, (3) if the transducer is mounted at the pipe's centerline on the same diameter, or (4) if the scale is too thick or the pipe mounting is distorted in shape, etc.

2.20 Install Question

1. Pipe parameters entered must be accurate; otherwise the flowmeter will not work properly.
2. During the installation, apply enough coupling compounds in order to stick the transducer onto the pipe wall. While checking the signal strength and Q value, move the transducer slowly around the mounting site until the strongest signal and maximum Q value can be obtained. Make sure that the larger the pipe diameter, the more the transducer should be moved. Check to be sure the mounting spacing is accordance with the display in Window M25 and the transducer is mounted at the pipe's centerline on the same diameter. Pay special attention to those pipes that formed by steel rolls (pipe with seams), since such pipe is always irregular. If the signal strength is always displayed as 00.0, that means there is no signal detected. Thus, it is necessary to check that the parameters (including all the pipe parameters) have been entered accurately. Check to be sure the transducer mounting method has been selected properly, the pipe is not worn-out, and the liner is not too thick. Make sure there is indeed fluid in the pipe or the transducer is not very close to a valve or elbow, and there are not too many air bubbles in the fluid, etc. With the exception of these reasons, if there is still no signal detected, the measurement site has to be changed.
3. Make sure that the flowmeter is able to run properly with high reliability. The stronger the signal strength displayed, the higher the Q value reached. The longer the flowmeter runs accurately, the higher the reliability of the flow rates displayed. If there is interference from ambient electromagnetic waves or the signal detected is too poor, the flow value displayed is not reliable; consequently, the capability for reliable operation is reduced.
4. After the installation is complete, power on the instrument and check the result accordingly.

3. Operating Instructions

3.1 System Normal Identification

Press the **MENU** **0** **8** keys. If the letter “*R” displays on the screen, it indicates system normal. If the letter “E” is read, it indicates that the current loop output is over ranged by 100%. This refers to the settings in Window M56. Enter a larger value in Window M56, and the letter “E” will disappear. It can be ignored if no current loop output is used.

If the letter “Q” is read, it indicates that the frequency output is over ranged by 120%, and this refers to the settings in Window M67. Increase the input value in Window M67, and the letter “Q” will disappear. It can be ignored if no frequency output is used.

If the letter “H” is read, it indicates that the ultrasonic signal detected is poor. For more information, please refer to Chapter of Error Diagnoses.

If the letter “G” is read, it indicates that system is adjusting the signal gain prior to the measurement. Also, it means system normal. Only when the adjustment takes too long without stopping, can system be identified as abnormal.

Letter “I” indicates no signal is being detected. Check the transducer wiring connections are correct, the transducers are installed firmly, etc.

Letter “J” indicates a hardware defect exists. Normally, such defect is temporary; it could be eliminated by system reboot (power off and restart). For further information, please refer to Chapter of Error Diagnoses.

3.2 Measurement Units Options

Window No.30 is available for British or Metric system options. Select 0 for Metric units, 1 for British units. Press the **MENU** **3** **0** **ENT** keys, and the symbol of “>” will be displayed on the bottom left line of the screen. It indicates that the screen is ready for unit’s options selection. Press the **▼/–** or **▲/+** key to select the desired flow units, and then press the **ENT** key again to confirm.

3.3 Flow Rate Units Options

Window M31 is available for flow rate unit options. Press the **MENU** **3** **1** keys to enter Window M31. Press the **ENT** key. The symbol “>” is displayed on the bottom line of the screen; it indicates that the screen is ready for selection. Press the **▲/+** or **▼/–** key to select the desired flow rate units. Press the **ENT** key to enter the screen for time unit options. Per the same selections as are in **Section 3.3**, move **▲/+** or **▼/–** key to select the desired time unit; then press the **ENT** key again to confirm.

3.4 Totalizer Units Options

Window M32 is available for totalizer unit options. The operation is as same as described in **Section 3.2**.

3.5 Totalizer Multiplier Options

The totalizer multiplier is used to expand the indication range of the totalizer. It can be selected in Window M33.

3.6 On/off Net Totalizer

Window M34 is available to turn net totalizer on and off net. Window M35 is available to turn the positive totalizer on and off, while Window M36 is for the negative totalizer. Select “On” to activate the totalizer and “Off” to de-activate the totalizer.

3.7 Totalizer Reset

Window M 37 is available to select and reset the desired totalizer. Generally, it is unnecessary to activate this function except during the initial installation.

3.8 Factory Default Recovery

Press the **MENU** **3** **7** keys to enter Window M37, press the **.** **◀** keys, and the factory default values are recovered.

3.9 Damping

The damping function will stabilize the flow display. Essentially, it is a part of the signal filter. Enter a coefficient in Window M40. Increasing the coefficient increases the stability. However, the measurement displayed may be slightly delayed due to over damping. Logging too long may result in no response to real-time fluctuation, especially when flow rate fluctuates wildly. Therefore, damping should be kept at a minimum and increased just enough to reduce the fluctuation to an acceptable degree by 3 to 10 seconds. This window is for data input. After entering the window, input the coefficient, then press the **ENT** key to confirm.

3.10 Low Flow Cutoff

The data displayed in Window M41 is called the low flow cutoff value. If the flow rate falls below the low flow cutoff value, the flow indication is driven to zero. This function can prevent the flowmeter from reading flow after a pump as shut down but there is still liquid movement in the pipe, which will result in totalization error. Generally, 0.03m/s is recommended to enter as the low flow cutoff point. The low flow cutoff value has no relation to the measurement results once the velocity increases over the low flow cutoff value.

3.11 Zero Set Calibration

Once zero flow occurs, a zero point may indicated on each measuring instrument, i.e. as the measurement value reaches zero flow, it is indicated as zero. It is necessary to establish the true zero flow condition and program that set point into the instrument.

If the zero set point is not at true zero flow, a measurement difference may occur. The smaller the physical measurement capacity is, the larger the measurement difference from the zero point will exist. Only when zero point reduced to a definite degree, as compared with the physical measurement capacity, can the measuring difference from zero point be ignored.

For an ultrasonic flowmeter, the measurement difference from zero point cannot be ignored at low flow. It is necessary to perform a zero set calibration to improve low flow measurement accuracy.

Press the **MENU** **4** **2** ensure that the fluid is definitely at a static state (true zero) and the flowmeter is working properly. Press the **ENT** key and wait until the counter readings displayed in the lower right corner of the screen goes to "00"; thus, the zero set is completed and the instrument indicates the results automatically through Window M01. Repeat zero set calibration if it still needs to be minimized, i.e. the velocity reading is still high.

3.12 Scale Factor

Scale factor refers to the ratio between "actual value" and "reading value". For instance, when the measurement is 2.00, and it is indicated as 1.98 on the instrument, the scale factor reading is 2/1.98. This means that the best scale factor constant is 1.

However, it is difficult to keep the scale factor as "1" on the instrument especially in batch control operations. The difference is called "consistency". High quality products always require high consistency. The scale factor default is "1" for each instrument prior to shipment from the factory. The reason is that the scale factors in AUF-750 flowmeter are only limited by two parameters, i.e. the crystal oscillation frequency and the transducer. It has no relation to any circuit parameters.

During operation, there still exists possible difference in pipe parameters, etc. The "scale factor" may be necessary when used on different pipes. Thus, scale factor calibration is specially designed for calibrating the differences that result from application on different pipes. The scale factor entered must be one that results from actual calibration.

3.13 System Lock (Unlock)

System lock is readable but uneditable to prevent operation error due to unauthorized tampering by unauthorized personnel.

Press the **MENU** **4** **7** **ENT** keys, move **▲/+** or **▼/-** key to select "Lock", press the **ENT** key, enter a 1~4 numerically long password, and then press the **ENT** key to confirm.

Unlock using the selected password only. Press **MENU** **4** **7** **ENT**, move **▲/+** or **▼/-** to select

"Unlock", press **ENT**, enter the correct password, then press **ENT** to confirm.

Keep the password in mind or recorded in a safe place or the instrument cannot be used.

§* Keyboard locked, avoid non-related person operation.

Locked way: Please get into the locked window, and please enter **MENU** **4** **8**, then enter **ENT**, input the password, it will returned back to the window .The keyboard will lose efficacy now.

Unlock way: Insert the passwork in the keyboard, the password won't display .Only when you input the correct password, then you could use it.

3.14 4~20mA Current Loop Verification

Possessing a current loop output exceeding an accuracy of 0.1%, the AUF-750 is programmable and configurable with multiple output modules such as 4~20mA or 0~20mA. Select in Window M54. For details, please refer to Chapter of Windows Display Explanations.

In Window M55, enter a 4mA flow value. Enter the 20mA flow value in Window M56. For instance, if the flow range in a specific pipe is 0~1000 m³/h, enter 0 in Window M55 and 1000 in Window M56. If the flow ranges from -1000~0~2000 m³/h, configure the 20~4~20mA module by selecting Window M54 when flow direction is not an issue. Enter 1000 in Window M55 and 2000 in Window M56. When flow direction is an issue, module 0~4~20mA is available. When the flow direction displays as negative, the current output is in range of 0~4mA, whereas the 4~20mA is for the positive direction. The output module options are displayed in Window M54. Enter "-1000" in Window M55 and 2000 in Window M56. Calibrating and testing the current loop is performed in Window M57. Complete the steps as follows:

Press **MENU** **5** **7** **ENT**, move **▲/+** or **▼/-** to display "0mA", "4mA", "8mA", "16mA", "20mA" readings, connect an ammeter to test the current loop output and calculate the difference. Calibrate it if the difference is within tolerance. Check the present current loop output in Window M58 as it changes along with change in flow.

3.15 Frequency Output

The AUF-750 is provided with a frequency output transmitter function. The high or low frequency output displayed indicates the high or low flow rate reading. The user can reset the frequency output as well as flow rate per his requirements.

For instance: if a pipe flow range is 0~3000 m³/h, the relative frequency output required is 123~1000Hz, and the configuration is as follows:

In Window M66 (low limit frequency output flow value), input 0;

In Window M67 (high limit frequency output flow value), input 3000;

In Window M65 (low limit frequency), input 123;

In Window M65 (high limit frequency), input 1000.

There is no output circuit specially assigned to frequency output. It only can be transmitted through OCT, i.e. select item 13 in Window M78 (item "OCT. FO").

3.16 Totalizer Pulse Output

Each time the AUF-750 reaches a unit flow, it may generate a totalizer pulse output to a remote counter to configure the unit flow.

The totalizer pulse output can be transmitted through OCT or a relay. So, it is necessary to configure OCT and the relay accordingly. (Please refer to Window M78 and M79). For instance, if it is necessary to transmit the positive totalizer pulse through a relay, and each pulse represents a flow of 0.1m³; the configuration is as follows:

1. In Window M32, select totalizer the flow unit "Cubic Meters (m³)";
2. In Window M33, select the scale factor "2. x0.1";
3. In Window M78, select "9. Positive totalizer pulse output";

Note: Make sure to select a suitable totalizer pulse, since the output may be extended if it is too large. If it is too small, the relay may activate too frequently and may probably shorten its life. Furthermore, if it operates too fast, it may generate a pulse loss error. Therefore, a rate of 1~60/minute is recommended.

3.17 Alarm Programming

The AUF-750 has on off output alarm,

The on-off output alarm is generated through OCT or transmission to an external circuit by opening or closing a relay. The on-off output signal is activated under the following conditions:

1. Signal not detected;
2. Poor signal detected;
3. The flowmeter is not ready for normal measurement;
4. The flow is in the reverse direction (back flow).
5. The analog outputs exceed span by 100%.
6. The frequency output exceeds span by 120%.
7. The flow rate exceeds the ranges configured (Configure the flow ranges using the software alarm system).

There are two software alarms: Alarm#1 and Alarm #2. The lower limit value for Alarm#1 is configured in Window M73, and the upper limit value is configured in Window M74. As for Alarm#2, the lower limit value is in F75 and the upper one is in Window M76).

Example 1: To program the relay output alarm, activated when flow rate exceeds 300~1000m³/h:

1. In Window M73, input 300;
2. In Window M74, input 1000;
3. In Window M79, select item 6: "6. Alarm #1 limit exceed".

Example 2: To program OCT output alarm signal, activated when flow rate exceeds 100~500m³/h; relay output alarm signal activated when flow rate exceeds 600~1000m³/h:

1. In Window M73, input 100;
2. In Window M74, input 500;
3. In Window M75, input 600;
4. In Window M76, input 1000;
5. In Window M78, select item 6: "6. Alarm #1 limit exceed".
6. In Window M79, select item 6: "6. Alarm #1 limit exceed".

3.18 OCT Output

The OCT output is a kind of isolated collector open circuit output with programmable open and close qualifications. The user can program the open and close functions as Totalizer Pulse Output.

3.19 Relay Output

The relay output in the AUF-750 flowmeter is programmable. The user can program the open and close functions as Totalizer Pulse Output. For details, please refer to Window M79.

3.20 Date and Time Settings

Generally, it is unnecessary to modify date time as the system is provided with a highly reliable perpetual calendar chip. If necessary, key in the **MENU** **6** **0** buttons to enter the window, then press **ENT** to see '>' displayed on the bottom left line of the screen. It indicates that the screen is ready for the modification. Press **.** to skip the numbers that do not need to be changed, and then press **ENT** again to confirm the modification.

3.21 LCD Backlit Options

Adjust the backlighting in Window M70. Press **MENU** **7** **0**, press **ENT**, and look for the '>' displayed on the bottom left line of the screen. It indicates that the screen is ready for modification. Press **▲/+** or **▼/-** to select "Always On"; it indicates that the backlighting will remain on always. If you select "Always Off", it indicates that the backlighting will remain off always. Select "Time=", then enter the desired backlighting time for "n" seconds; it indicates that after pressing the button, the backlighting will keep on for "n" seconds then turn off automatically.

3.22 Daily, Monthly, Yearly Totalized Flow

In Window F09, the history file storage for the last 64 days can be reviewed.

Press **MENU** **8** **2**, select item 0 for "Day" and it will display on the Screen as shown on the right: Left upper corner: "00"- "63" indicates the serial numbers; In the middle: "00-07-21" indicates the date; Upper right corner: "-----" indicates the working condition.

M 82
Date Totalizer
0. Day

If there is only "-----" displayed, it indicates the system was normal during that time period. If other characters displayed, please refer to the "Error Code and Resolutions". The following numerical value 3412.53 indicates the net totalized flow for a specific day.

To review the flow for a month, press **MENU** **8** **2**, and select item 1 for "Month".

To review the flow for a year, press **MENU** **8** **2**, and select item 2 for "Year".

3.23 Automatic Flow Correction

In Window M.2, select "4", press **ENT**, select "1", the lost flow during an offline session will be automatically recovered into the flow totalizer as soon as the next power on.

3.24 Working Timer

Window F.2 displays the total running hours since last reset.

3.25 Batch Controller

The batch controller is able to perform flow quantity control. The AUF-750 is able to take the high or low end of analog input signals as an input, or through the keypad, to perform control functions. The output can be transmitted through OCT or a relay.

When taking analog inputs as control signals, input an analog output which is over 2mA through the analog input terminal to indicate the condition of "1"; current "0" indicates the condition of "0".

In Window M78 (OCT output) or M79 (relay output), the OCT or relay output will generate output signals.

3.26 Analog Output Calibration

Each flowmeter has been calibrated strictly before leaving factory. It is unnecessary to carry through this step except when the current value (detected while calibrating the current loop) displayed in Window M62 is not identical with the actual output current value.

The hardware detect window must be activated prior to calibration. The procedure is as follows:

Press **MENU** **6** **2** **ENT** to calibrate the current loop 4mA output. Use an ammeter to measure the current loop output current. At the same time, move **▲/+** or **▼/-** to adjust the displayed numbers. Watch the ammeter until it reads 4.00. Stop at this point, the 4mA has been calibrated. Then, press **ENT** to calibrate the current loop 20mA output. The method is as same as in 4mA calibration.

3.27 Software Version and ESN

We provide the AUF-750 with a unique electronic serial number to identify each flowmeter for the convenience of the manufacturer and customers. The ESN, instrument types and versions are able to view in Window M61.

4. Windows Display Explanations

4.1 Windows Display Codes

Item	Flow Totalizer Display	Item	Setup Options	Item	Calorimetry
00	POS / NEG / NET Totalizer	46	Network I DN		Diagnoses
01	POS / Flow Rate/Velocity	47	System Lock	90	Strength+Quality
02	NEG / Flow Rate/ Velocity	48	System Lock Code Entry	91	TOM/TOS*100
03	NET / Flow Rate/ Velocity	49	Communication Te	92	Fluid Sound Velocity
04	Date/ Time/ Flow Rate			93	Total Time and Delta
05	Instantaneous Caloric / Totalized Caloric / Velocity		Setup Calibration	94	Reynolds Number
06	Analog Input AI1, AI2	50	Logger Option		Appendix
	Others	51	Logger Time	*0	ON/OFF Time
07	System Error Codes	52	Printing To	*1	Total Work Hours
08	Daily, Monthly, Yearly Totalized Flow	53	CL Calibration	*2	Last Off Time
		54	CL Mode Select	*3	Last Flow Rate
	Initial Parameter setup	55	CL(mA)4 Output V	*4	ON/OFF Times
10	Pipe Outside Perimeter	56	CL 20mA Output V	*5	Velocity Change
11	Pipe Outside Diameter	57	CL Checkup	*6	Protocol Select
12	Pipe Wall Thickness	58	CL Current Output	*7	Heat Capacity
13	Pipe Inside Diameter				
14	Pipe Material	60	Date and Time		
15	Pipe Sound Velocity	61	VER and ESN		
16	Liner Material	62	RS-232C Setup		
17	Liner Sound Velocity	63	AI1 Value Range		
18	Liner Thickness	64	AI2 Value Range		
19	Inside ABS thick	65	FO Frequency Range		
20	Fluid Type	66	Low FO Flow Rate		
21	Fluid Sound Velocity	67	High FO Flow Rate		
22	Fluid Viscosity				
23	Transducer Type		Setup alarm		
24	Transducer Mounting	70	LCD Backlit Option		
25	Transducer Spacing	71	LCD Contrast		
26	Parameters Setup	72	Working Timer		
27	Current Section	73	Alarm #1 Low Value		
28	Holding With Poor	74	Alarm #1 High Value		
29	Empty Pipe Setup	75	Alarm #2 Low Value		
	Flow Units Options	76	Alarm #2 High Value		
30	Measurement Unit	77	BUZZER Setup		
31	Flow Rate Units	78	OCT Output Setup		
32	Totalizer Units	79	Relay Output Set		
33	Totalizer Multip	80	Flow Batch CTRL		
34	NET Totalizer	81	FlowBatch Contro		
35	POS Totalizer	82	Date Total izer		
36	NEG Totalizer	83	Auto Amending		
37	Totalizer Reset	84	Energy Units Sel		
38	Manual Totalizer	85	Temperature Sele		
39	Language	86	Spec Heat Select		
40	Damping	87	Energy Totalizer ON/OFF		
41	Low Flow Cutoff	88	Energy Multiplier		
42	Set Zero	89	Reset Energy Totalizer		
43	Reset Zero				
44	Manual Zeropoint				
45	Scale Factor				

4.2 Display explanation

While reading this section, please compare it with the instrument in order to improve your understanding.

MENU 0 0

POS/NEG/NET/S,Q

Display POS Totalizer, NEG Totalizer, NET Totalizer and S,Q Value.
If flowmeter installed correct, S & Q value need to higher then 60.

POS	+ 6 m3
NEG	-2 m3
NET	+ 4 m3
S=81.4	,81.4 Q=83.2

MENU 0 1

POS/Flow Rate/ Velocity /S,Q

Display POS Totalizer, Flow Rate, Velocity and S,Q Value.
If the pos totalizer has been turned off (refer to M35), the postotalizer value displayed is the total prior to its turn off.
Select the positive totalizer units in Window M32.

POS	+6 m3
Flow	0.0000 m3/h
Vel	0.0000 m/s
S=81.4	,81.4 Q=83.2

MENU 0 2

NEG/Flow Rate/ Velocity /S,Q

Display NEG Totalizer, Flow Rate, Velocity and S,Q Value.
If the neg totalizer has been turned off (refer to M36), the postotalizer value displayed is the total prior to its turn off.
Select the positive totalizer units in Window M32.

NEG	-2 m3
Flow	0.0000 m3/h
Vel	0.0000 m/s
S=81.4	,81.4 Q=83.2

MENU 0 3

NET/Flow Rate/ Velocity /S,Q

Display NET Totalizer, Flow Rate, Velocity and S,Q Value.
If the net totalizer has been turned off (refer to M34), the postotalizer value displayed is the total prior to its turn off.
Select the positive totalizer units in Window M32.

NET	+4 m3
Flow	0.0000 m3/h
Vel	0.0000 m/s
S=81.4	,81.4 Q=83.2

MENU 0 4

Date Time/Flow Rate

Display the current date time and flow rate.
The time setting method is found in Window M60.

Date	08-08-08
Time	08:08:08
Flow	0.0000 m3/h
S=81.4	,81.4 Q=83.2

MENU 0 5

Date Time/Flow Velocity

Display the current date time and Velocity.

EFR	0.000GJ/h
E.T	0E0GJ
Vel	0.0000 m/s
S=81.4	,81.4 Q=83.2

MENU 0 6

Caloric/Totalized Caloric

Display Instantaneous Caloric and Totalized Caloric.

AI1=	0.0000
	-12.490
AI2=	0.0000
	-12.490

MENU 0 7

System Error Codes

Display the working condition and the system error codes.
Morethan one error code can occur at the same time.
The explanations of error codes and detailed resolution methods can be found in Chapter 5 – Defect Diagnoses.

Error Code

System Normal
S=81.4 ,81.4 Q=83.2

MENU 0 8

NET Totalizer Today

Display NET Totalizer Today .

M 08
Net FLOW Today
+231.22 m3

MENU 1 0

PIPE Outer Perimeter

Enter the PIPE OUTER PERIMETER

M 10
Pipe Outer Perim
339.292 mm

MENU 1 1

Pipe Outside Diameter

Enter the pipe outside diameter, or enter pipe circumference in Window M10. The pipe outside diameter must range from 15mm to 6000mm.
 Note: Enter either pipe outside diameter or pipe circumference.

M 11
 Pipe Outer Diame
 108 mm

MENU 1 2

Pipe Wall Thickness

Enter the pipe wall thickness. If the pipe inside diameter is already known, skip this window and enter it in Window M13.

M 12
 Pipe Wall Thickn
 3.6 mm

MENU 1 3

Pipe Inside Diameter

Enter the pipe inside diameter. If the pipe outside diameter (or circumference) and pipe wall thickness has been entered, press “▼” to skip this window.
 Note: Enter either pipe wall thickness or pipe inside diameter.

M 13
 Pipe Inner Diame
 100.8 mm

MENU 1 4

Pipe Material

Enter pipe material. The following options are available (by “▼”, “▲” buttons or numerical keys):

- 0. CARBON STEEL
- 1. STAINLESS STEEL
- 2. CAST IRON
- 3. DUCTILE IRON
- 4. COPPER
- 5. PVC
- 6. ALUMINUM
- 7. ASBESTOS
- 8. FIBERGLASS—EPOXY
- 9. OTHER

Refer to item 9 “Other”; it is possible to enter other materials, which are not included in previous eight items. Once item 9 is selected, the relevant pipe sound velocity must be entered in Window M15.

M 14
 Pipe Material
 5. PVC

MENU 1 6

Liner Material

Select the liner materials.
 The following options are available:

- 0. NONE—NO LINER
- 1. TAR EPOXY
- 2. RUBBER
- 3. MORTAR
- 4. POLYPROPYLENE
- 5. POLYSTYRYOL
- 6. POLYSTYRENE
- 7. POLYESTER
- 8. POLYETHYLENE
- 9. EBONITE
- 10. TEFLON
- 10. OTHER

Item 11 “Other” is available to enter other materials that are not included in previous ten items. Once the “Other” is selected, the relevant liner sound velocity must be entered in Window M17.

M 16
 Liner Material
 0. None Liner

MENU 2 0

Fluid Type

Select the fluid type. The following options are available:

- 0. WATER
- 1. SEA WATER
- 2. KEROSENE
- 3. GASOLINE
- 8. OTHER
- 9. DIESEL OIL
- 10. CASTOR OIL
- 11. PEANUT OIL

M 20
 Fluid Tyoe
 0. Water

- 4. FUEL OIL 12. GASOLINE #66
- 5. CRUDE OIL 13. GASOLINE #80
- 6. PROPANE (-45C) 14. ALCOHOL
- 7. BUTANE (0C) 15. WATER (125C)

“OTHER” means you can go to keyin Ultrasonic speed for the fluid. In M21

MENU 2 3

Transducer Type

Select the Transducer type. The following options are available:

- STANDARD - M** 5. PLUG IN B45 10. STANDARD – M1
- PLUG IN TYPE (C) 6. **STANDARD – L** 11. STANDARD – S1
- STANDARD – S** 7. SCRA HUIZHONG 12. STANDARD – L1
- USER TYPE 8. STANDARD - HS
- STANDARD - B 9. STANDARD - HM

M 23
Transducer Type
0. Standard - M

****For Alia sensor you only need to choose :**

- 0. STANDARD – M 2. STANDARD – S 6. STANDARD – L**

MENU 2 4

Transducer Mounting

Four mounting methods are available:

- 0. V (V Method, sound wave bounces 2 times)**
- 1. Z (Z Method, sound wave bounces once)**
- 2. N (Small Pipe) (N Method, sound wave bounces 3 times.)
- 3. W (Tiny Pipe) (W Method, sound wave bounces 4times.)

M 24
Transducer Mount
0. V

MENU 2 5

TRANSDUCER SPACING

Transducer Spacing (*this value is CALCULATED by the AUF 750*)

The operator must mount the transducer according to the transducer spacing displayed (be sure that the transducer spacing must be measured precisely during installation). The system will display the data automatically after the pipe parameter had been entered.

M 25
Transducer Spaci
72.8337 mm

MENU 2 6

Parameter Setup and Save

Load and save the parameters. and save by three methods

- 0. Entry to Save
- 1. Entry to Load
- 2. To Browse

M 26
Parameter Setup
ENTRY TO SAVE

MENU 2 7

CURRENT AREA

Display the current area inside the pipe.

M 27
Current Section
7389.81 mm2

MENU 2 8

Holding when poor ultrasonic signal

When Flowmeter with poor signal, keep the flowrate data Condition.

M 28
Holding with Poo
YES

MENU 2 9

Empty Pipe Setup

Setup a S value, when the value lower then this value, theFlowrate will go to 0.

M 29
Empty Pipe Setup
0

MENU 3 0

Measurement Units Options

Select the measurement unit as follows:

- 0. Metric
- 1. English

Factory default is **metric**.

M 30
Measurement Unit
0. Metirc

MENU 3 1

Flow Rate Units Options

Select the flow rate units and time units.
 The following flow rate units are available:
 0. CUBIC METERS
 1. LITERS
 2. (AMERICAN) GALLONS
 3. IMPERIAL GALLONS
 4. MILLION GALLONS
 5. CUBIC FEET
 6. (AMERICAN) BARRELS
 7. IMPERIAL BARRELS
 8. OIL BARRELS
 The following time units are available:
 /Day /Hour /Min /Sec
 Factory default is Cubic **Meters/hour**.

M 31
 Flow Rate Units
 m3/h

MENU 3 2

Totalizer Units Options

Select the totalizer units. The available unit options are as same as those found in Window M31.
 The user can select units as their required. Factory default is **Cubic Meters**.

M 32
 Totalizer Units
 m3

MENU 3 3

Totalizer Multiplier Options

The totalizer multiplier acts as the function to increase the totalizer indicating range. Meanwhile, the totalizer multiplier can be applied to the positive totalizer, negative totalizer and net totalizer at the same time. The following options are available:
 0. x 0.001 (1E-3) 1. x 0.01
 2. x 0.1 3. x 1
 4. x 10 5. x 100
 6. x 1000 7. x 10000(1E+4)
 Factory default factor is **x1**

M 33
 Totalizer Multiplier
 3. X 1

MENU 3 4

ON/OFF Net Totalizer

On/off net totalizer. "ON" indicates the totalizer is turned on, while "OFF" indicates it is turned off. When it is turned off, the net totalizer displays in Window M00 will not change. Factory default is "ON".

M 34
 NET Totalizer
 ON

MENU 3 5

ON/OFF Positive Totalizer

On/off positive totalizer. "ON" indicates the flowmeter starts to totalize the value. When it is turned off, the positive totalizer displays in Window F02. Factory default is "ON".

M 35
 POS Totalizer
 ON

MENU 3 6

ON/OFF Negative Totalizer

On/off negative totalizer. "On" indicates the totalizer is turned on. When it is turned off, the negative totalizer displays in Window F03. Factory default is "ON".

M 36
 NEG Totalizer
 ON

MENU 3 7

Totalizer Reset

Totalizer reset; all parameters are reset. Press **ENT**; move "UP" or "DOWN" arrow to select "YES" or "NO". After "YES" is selected, the following options are available:
 0. NONE
 1. ALL
 2. NET
 3. POSITIVE
 4. NEGATIVE

M 37
 Totalizer Reset ?
 Selection

If it is necessary to recover the factory default, press **[.]** **[←]** keys after the above-mentioned characters are displayed on the screen.

MENU **[3]** **[8]**

Manual Totalizer

Display the manual totalizer, Please press **[ENT]** to start, and press **[ENT]** again to stop.

M 38
Manual Totalizer
Pre ENT When Ready

MENU **[3]** **[9]**

Language Select

Select Language

- 0. Chinese
- 1. English.

M 39
Language
English

MENU **[4]** **[0]**

Damping

The damping factor ranges from 0~999 seconds.

0 indicates no damping; 999 indicate the maximum damping.

Damping functions to display the data smoothly. Its principle is as same as that in a single-section RC filter.

The damping factor value corresponds to the circuit time constant. Usually a damping factor of 3 to 10 is recommended in applications.

M 40
Damping
5 Sec

MENU **[4]** **[1]**

Low Flow Cutoff Value

The Low flow cutoff may be used in order to make the system display a “0”

value at lower and smaller flows to avoid incorrect totalization. For instance, if the cutoff value is set as “0.03”, system will take all the measured flow values of ± 0.03 as “0”.

Usually 0.03 is recommended in most applications.

M 41
Low Flow Cutoff
0.03 m/s

MENU **[4]** **[2]**

Set Zero

When fluid is in the static state, the displayed value is called “Zero Point”.

When “Zero Point” is not at zero in the flowmeter, the difference is going

to be added into the actual flow values and measurement differences will occur in the flowmeter.

Set zero must be carried out after the transducers are installed and the flow inside the pipe is in the

absolute static state (no liquid movement in the pipe).

Please press **[ENT]** to start.

M 42
Set Zero
Press ENT To Go

MENU **[4]** **[3]**

Reset Zero

If the zero flow not correct, use this function to get the original Zero Value.

- 1. ON
- 2. OFF

M 43
Reset Zero
No

MENU **[4]** **[4]**

Manual Zero Point

This method is not commonly used. It is only suitable for experienced operators to set zero under conditions when it is not preferable to use other methods. Enter the value manually to add to the measured value to obtain the actual value.

Normally, set the value as “0”.

M 44
Manual Zero Point
0 m3/h

MENU 4 5

Scale Factor

The scale factor is used to modify the measurement results. Factory default is 1. The user can enter a numerical value other than “1” according to calibration results.

M 45
Scale Factor
1

MENU 4 6

Network IDN

Input system identifying code, these numbers can be selected from 0~65535 except that 13 (0DH ENTER), 10 (0AH Newline), 42 (2AH *) and 38 (26H&) are reserved. System IDN is used to identify the flowmeter to a network.

M 46
Network IDN
1

MENU 4 7

System Lock

Once the system is locked, any modification to the system is prohibited, but the parameter is readable. “Unlock” using your designated password. The password is composed of 1 to 4 numbers
(**Please contact the factory if the password is forgotten.**)

M 47
System Lock
** Unlocked *

MENU 4 8

Keyboard locked

This window was used to avoid non operator not to do the operation. Detail please check §3.13

M 48
Keypad Lock Code
Entry

MENU 4 9

Communication function test

M 49
Communication Te

MENU 5 0

Logger setup

This window can set up open or close the print function and can also set up the specific time to print. enter **ENT**, use up and down arrowhead to select “ON” or “OFF”. “OFF” means close the print function. When you set up “ON”, the system will ask user to select following items in specific time.

- | | |
|-----------------------|-----------------------|
| 0. DATE, TIME | 7. NEGATIVE TOTALIZER |
| 1. SYSTEM STATE | 8. SIGNAL STRENGTH |
| 2. CURRENT WINDOW | 9. ENERGY FLOW RATE |
| 3. FLOW RATE | 10. ENERGY TOTALIZER |
| 4. VELOCITY | 11. AI1 |
| 5. NET TOTALIZER | 12. AT2 |
| 6. POSITIVE TOTALIZER | 13. WORK—TIMER |
| | 14. FLOW TODAY |

Every items selected “ON” means in specific time it will Print; “OFF” means no print.

M 50
Logger Option
OFF

MENU 5 1

Set up the specific time printing

This window use to set up the specific time printing. The interval, the smallest unit is second. When you input **. **. **. ** before the print, that means print right now. If you set with 23:10:10, that's mean time in 23:10:10 will start the print. If you keyin to GO ON value = **. **. **. **, the means the log time will no ending.

When you set up the print time, please enter **ENT** into to the interval. The max. value of interval time is 24hours.

M 51
Logger Time
Start 00:00:00
Interval 00:00:00
GO ON 00:00:00

MENU 5 2

Communication data condition

Check output to RS232C. Can't change.

M 52
Printing To
Only To RS232C

MENU 5 3

4-20mA electric current calibration

This window can calibrate 4-20mA current, detail please check§3.30

M 53
CL Calibration
Pre ENT When Rea

MENU 5 4

Current Loop Mode Select

Select the current loop mode. The following options are available:

- 0. 4—20mA
- 1. 0—20mA
- 2. 0—20mA via RS23
- 3. DISABLE
- 4. 20—4—20mA
- 5. 0—4—20mA
- 6. 20—0—20mA
- 7. 4—20Ma vs. VEL.

M 54
CL Mode Select
0. 4 - 20mA

The Serial Port controls the output according to the command and parameter entered in the RS232 to output a definite current value through the current loop. The command formats are narrated in the command explanations to Serial Port controls. For instance, if it is necessary to output a 6mA current through the current loop, it can be realized by setting Window M54 to the mode “0-20mA Via RS232” and giving a command as “AO6 (CR)”. This function is able to make the flowmeter operate a control valve conveniently.

Other different current output characteristics are displayed in above figures. The user can select one of them according to his actual requirements.

In four graphs shown above, flow F0mA or F4mA indicates the value that user entered in Window M55; and flow F20mA indicates the value that customer entered in Window M56. In the 4-20mA and 0-20mA modes, F0mA (or F4mA) and F20mA can be selected as a positive or negative flow value as long as the two values are not the same. As for modes 20-4-20mA and 20-0-20mA, the AUF750 ignores the positive and negative

value of the actual flow; therefore, both F0mA (or F4mA) and F20mA must be selected as positive flow values. In mode 0-4-20mA, F0mA must be select as a negative value and F20mA as a positive value. Furthermore, in mode 4-20mA, the output current is indicated as velocity.

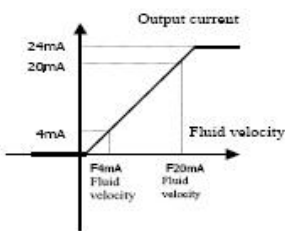

Fluid velocity/ 4-20mA output

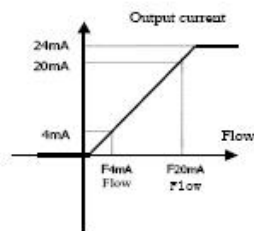

4-20mA mode output

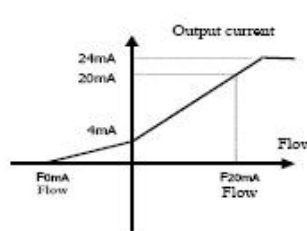

0-4-20mA mode output

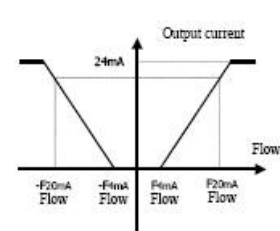

20-0-20mA mode output

MENU 5 5

CL 4mA or 0mA Output Value

Set the CL output value according to the flow value at 4mA (4mA or 0mA are determined by the settings in Window M54) . The flow unit’s options are as same as those in Window M31. Once “**velocity 4-20mA**” is selected in Window M54, the unit should be set as **m/s**.

M 55
CL (mA) 4 Output V
0 m3/h

MENU 5 6

20mA Output Value

Set the CL output value according to the flow value at 20mA. The flow unit is the as same as that found in Window M31.

M 56
CL 20mA Output V
1440 m3/h

MENU 5 7

mA output Simulation

This window can simulate mA output value, please see§3.15

M 57
CL Checkup
Pre ENT When Ready

MENU 5 8

mA output value

Check the mA output value

M 58
CL Current Output
4.000 mA

MENU 6 0

Date and Time Settings

Date and time modifications. The format for setting time setting is 24 hours. Press **[ENT]**, wait until ">" appears, the modification can be made.

M 60
Date 08-08-08
Time 08:08:08

MENU 6 1

Software Version and ESN

Display software version and electronic serial number (ESN) of the instrument.

This ESN is the only one assigned to each Innova-Sonic flowmeter ready to leave the factory.

The factory uses it for files setup and for management by the user.

M 61
Ver 8.10
ESN=08050356F

MENU 6 2

RS232 port setup

M 62
RS-232C Setup
28800 , None

MENU 6 3

AI1 Value Range

This window can setup 4-20 mA value for Temperature or Pressure transmitter range.

Example: 0 – 100

Means 4mA corresponded value is: 0

20mA corresponded value is: 100

M 63
AI1 Value Range
10 - 100

MENU 6 4

AI2 Value Range

This window can setup 4-20 mA value for Temperature or Pressure transmitter range.

Example: 0 – 100

Means 4mA corresponded value is: 0

20mA corresponded value is: 100

M 64
AI2 Value Range
10 - 100

MENU 6 5

FO Frequency Range

Set up Low or High FO frequency. It must be smaller than the high FO frequency. Ranges from 1-9999Hz. Factory default is 1000 Hz.

Note: Frequency output is transmitted through the OCT Serial Port; therefore, the OCT must be set to frequency output mode, if necessary.

M 65
FO Frequency Ran
1 - 1000

MENU 6 6

Low FO Flow Rate

Set up low FO flow rate, i.e. the corresponding flow value when output signal frequency is at the lowest FO frequency. For instance, when the low FO frequency is 1000Hz, low FO flow rate is 100m3/h (when the frequency output is 1000Hz, then the low flow at this moment measured by the flowmeter is 100m3/h).

M 66
Low FO Flow Rate
0 m3/h

MENU 6 7

High FO Flow Rate

Enter the high FO flow rate, i.e. the corresponding flow value when frequency output signal is at highest FO frequency.

M 67
High FO Flow Rate
26550 m3/h

MENU 7 0

LCD Backlit Option

- 0. ALWAYS OFF
- 1. ALWAYS ON
- 2. LIGHTING FOR

M 70
LCD Backlit Option
1. Always ON

MENU 7 1

LCD contrast control

This window can control LCD contrast.

M 71
LCD Contrast
0

MENU 7 2

Working Timer

This window can display total working hours

They unit are:Hour, minute, second

If you need reset to zero,please enter ENT key, select :YES

M 72
Working Timer
00000008:08:08

MENU 7 3

Alarm #1 low Value

Enter the alarm low value. Both relevant alarms are turned on in Windows M78 and M79; any measured flow, which is lower than the low value, will activate the alarm in the OCT hardware or relay output signal.

M 73
Alarm #1 Low Val
0 m3/h

MENU 7 4

Alarm #1 High Value

Enter the alarm High value. Both relevant alarms are turned on in Windows M78 and M79; any measured flow, which is lower than the low value, will activate the alarm in the OCT hardware or relay output signal.

M 74
Alarm #1 High Val
1440 m3/h

MENU 7 5

Alarm #2 low Value

Enter the alarm low value. Both relevant alarms are turned on in Windows M78 and M79; any measured flow, which is lower than the low value, will activate the alarm in the OCT hardware or relay output signal.

M 75
Alarm #2 Low Val
0 m3/h

MENU 7 6

Alarm #2 High Value

Enter the alarm High value. Both relevant alarms are turned on in Windows M78 and M79; any measured flow, which is lower than the low value, will activate the alarm in the OCT hardware or relay output signal.

M 76
Alarm #2 High Val
1440 m3/h

MENU 7 7

Buzzer Setting

This window can select Buzzer for:

- | | | |
|-----------------|-------------------|----------------------|
| 0. Not Using | 6. FO Over 120% | 12. NET INT Pulse |
| 1. No Signal | 7. Alarm #1 | 13. Energy Pulse |
| 2. Poor Singal | 8. Alarm #2 | 14. ON/OFF via RS232 |
| 3. Not Ready | 9. Batch Control | 15. Fluid Changed |
| 4. Reverse Flow | 10. POS INT Pulse | 16. Key Stroke ON |
| 5. AO Over 100% | 11. NEG INT Pulse | |

M 77
Buzzer Setup
Not Using

MENU 7 8

OCT Output Setup

Set up OCT output alarm signal. The circuit diagram is found on the next page.

The following signal options are available:

- | | |
|-------------------|----------------------|
| 0. NO SIGNAL | 9. POS INTEG PULSE |
| 1. POOR SIGNAL | 10. NEG INTEG PULSE |
| 2. Not Ready | 11. NET INTEG PULSE |
| 3. REVERSE FLOW | 12. ENERGY PULSE |
| 4. A.O. OVER 100% | 13. FO |
| 5. F.O. OVER 120% | 14. F.O via RS232 |
| 6. ALARM #1 | 15. ON/OFF via RS232 |
| 7. ALARM #2 | 16. FLUID CHANGED. |
| 8. BATCH CONTROL | 17. NOT USING |

M 78
OCT Output Setup
Not Using

MENU 7 9

Relay Output Setup

Set up the relay output signal options. The relay is single-pole and constant-on for external instrument controls. The following options are available:

- | | |
|-------------------|----------------------|
| 0. NO SIGNAL | 8. BATCH CONTROL |
| 1. POOR SIGNAL | 9. POS INTEG PULSE |
| 2. NOT READY | 10. NEG INTEG PULSE |
| 3. REVERSE FLOW | 11. NET INTEG PULSE |
| 4. A.O. OVER 100% | 12. ENERGY PULSE |
| 5. F.O. OVER 120% | 13. ON/OFF via RS232 |
| 6. ALARM #1 | 14. FLUID CHANGED. |
| 7. ALARM #2 | 15. NOT USING |

M 79
Relay Output Set
Not Using

MENU 8 0

Batch control function selection

This window can set batch control output with

- | | |
|------------------|------------------|
| 0. Key Input | 4. AI2 Down Edge |
| 1. AI1 Up Edge | 5. AI3 Up Edge |
| 2. AI1 Down Edge | 6. AI3 Down Edge |
| 3. AI2 Up Edge | 7. AI4 Up Edge |

M 80
Flow Batch CTRL
Key Input

MENU 8 1

Batch control valut setting

M 81
Flow Batch Control
1000 m3

MENU 8 2

YEARLY / MONTHLY / DAILY TOTALIZER

Display yearly, monthly, daily totalizer

0. DAILY
1. MONTHLY
2. YEARLY

M 82
Date Totalizer
0. Day

In this window, it is possible to review the historical flow data totalizer for any day for the last 64 days, any month for last 64 months and any year for last 5 years.

Press ENT, use the ▲/+ or ▼/- to review totalizer in days, months and years.

Use the ▲/+ or ▼/- to review the flow total for a specific day, month or year.

For instance, to display the flow total for July 18, 2000, the display "-----" at the upper right corner of the screen indicates that it was working properly the whole day. On the contrary, if "G" is displayed, it indicates that the instrument gain was adjusted at least once. Probably it was offline once on that day. If "H" is displayed, it indicates that poor signal was detected at least once. Also, it indicates that the operation was interrupted or problems occurred in the installation.

For details, please refer to Chapter 5 - Error Diagnoses.

MENU 8 3

Automatic compensate when Power off

This window can compensate the value for totalizer when power off.

0. OFF
1. ON

M 83
Auto Amending
ON

MENU 8 4

Energy Units Select

This window can select the unit "GJ" or "Kcal" for Energy Unit.

0. GJ
1. KC

M 84
Energy Units Sel
0. GJ

MENU 8 5

Temperature Select

Select temperature signal source of calorimetry:

0. Input from AI1, AI2
1. Fixed Difference in temperature

"0. From AI1, AI2" represent using AI1, AI2 analog input channel to input temperature signal. AI1, AI2 analog input must be 4~20mA or 0~20mA current signal sent from the temperature sensor.

"1. Fixed Difference" represents difference in temperature and is a fixed value entered by keypad. Enter fixed difference in temperature value after selected this item.

M 85
Temperature Sele
0. From AI1,AI2

MENU 8 6

Heat Capacity

Select the following 2 kinds of specific heat value:
 0. Standard Specific Heat
 1. Fixed Specific Heat.

M 86
 Spec Heat Select
 0. GB

Generally specific heat of water is 0.0041868GJ/M3°C.

MENU 8 7

Energy Totalizer Switch

Select "ON" represents to open Energy Totalizer
 Select "OFF" represents to close Energy Totalizer

M 87
 Energy Totler
 ON

MENU 8 8

Energy Multiplier

Select Energy Multiplier range: (E-4)--- (E6)
 0. x0.0001 (E-4) 6. x100 (E2)
 1. x0.001 (E-3) 7. x1,000 (E3)
 2. x0.01 (E-2) 8. x10,000 (E4)
 3. x0.1 (E-3) 9. x100,000 (E5)
 4. x1 (E0) 10. x1,000,000 (E6)
 5. x10 (E1)

M 88
 Energy Multiplie
 4. x1 (E0)

MENU 8 9

Reset Energy Totalizer

Select "YES" to reset Energy Totalizer value.

M 89
 Reset Energy Tot
 NO

MENU 9 0

Signal Strength and Signal Quality

Display the measured signal strength and signal quality Q value upstream and downstream. Signal strength is indicated from 00.0~99.9. A reading of 00.0 indicates no signal detected, while 99.9 indicates maximum signal strength. Normally the signal strength should be ≥ 60.0

M 90
 Strenth+Quality
 Q=81.4 ,81.4 Q=83.2

MENU 9 1

TOM/TOS*100

Display the ratio between the actual measured transmit time and the calculated transmit time according to customer's requirement. Normally the ratio should be $100 \pm 3\%$. If the difference is too large, the user should check that the parameters are entered correctly, especially the sound velocity of the fluid and the installation of the transducers.
This data is of no use before the system is ready.

M 91
 TOM/TOS*100
 100%

MENU 9 2

Fluid Sound Velocity

Display the measured fluid sound velocity. Normally this value should be approximately equal to the entered value in Window M21. If the difference is too large, it probably results from an incorrect value entered in Window M21 or improper installation of the transducers.

M 92
 Fluid Sound Vel
 0.0000 m/s

MENU 9 3

Total Time and Delta Time

Display the measured ultrasonic average time (unit: nS) and delta time of the upstream and downstream(unit: nS) time. The velocity calculation in the AUF750 is based on the two readings. The delta time is the best indication that the instrument is running steadily. Normally the fluctuation in the ratio of the delta time should be lower than 20%. If it is not, it is necessary to check if the transducers are installed properly or if the parameters have been entered correctly.

M 93
 Total Time , Delta
 0.0000 us
 0.0000 us

MENU 9 4

Reynolds Number and Factor

Display the Reynolds number that is calculated by the AUF750 and the factor that is set currently by the flowmeter. Normally this scaling factor is the average of the line and surface velocity factor inside the pipe.

M 94
Reynolds Number
0.0000 0.7500

MENU 9 5

POS Caloric and NEG Caloric

Display POS totalizer Caloric and NEG totalizer Caloric

ETP 0E2GJ
ETN 0E2GJ
VEL 0.0000 m/s
S=81.4 ,81.4 Q=83.2

MENU + 0

POWER ON/OFF MANAGER

Into this window, please enter ENT and press ▲ show last time, time before last time ..etc total 64 times record of power on, power off time and the flowrate value.

M +0
ON/OFF Time
Pre ENT When Ready

MENU + 1

Total Work Hours

Display total work hours

M +1
Total Work Hours
00000008:08:08

MENU + 2

Last Off Time

Display last off time

M +2
Last Off Time
Date 08-08-08
Time 08:08:08

MENU + 3

Last Flow Rate

Display last flow rate

M +3
Last Flow Rate
0 m3/h

MENU + 4

ON/OFF Times

Display ON/OFF Times

M +4
ON/OFF Times
8

MENU + 5

Velocity Change

Display Velocity Change

M +5
Velocity Change
1 m/s

MENU + 6

Protocol Select

Select the Protocol
0. protocol0AdXX
1. Protocol1Addc

M +6
Protocol Select
0. protocol0AdXX

MENU + 7

Heat Capacity

Display Heat Capacity value for two inputs

012
0.000000 GJ/m3
012
0.000000 GJ/m3

5. Error Diagnoses

The AUF750 ultrasonic flowmeter has advanced self-diagnostics functions and displays any errors in the upper right corner of the LCD via definite codes in a date/time order. Hardware error diagnostics are usually performed upon each power on. Some errors can be detected during normal operation. Undetectable errors caused by incorrect settings and unsuitable measurement conditions can be displayed accordingly. This function helps to detect the errors and determine causes quickly; thus, problems can be solved in a timely manner according to the solutions listed in the following tables.

Errors displayed in the AUF750 are divided into two categories:

Table 1 is for errors displayed during self-diagnostics upon power on. “* F” may be displayed on the upper left corner of the screen after entering the measuring mode. When this occurs, it is necessary to power on for self-diagnostics once again to detect and solve possible errors using the table below. If a problem still exists, please contact the factory or the factory’s local representative for assistance.

Table 2 applies when errors caused by incorrect settings and signals are detected and are announced by error codes displayed in Window M07.

Table 1. Self-diagnoses and error solutions (upon power on)

LCD Display	Cause	Solution
Rom Parity Error	* System ROM illegal or error	* Contact the factory
Stored Data Error	* System stored data block error	* Power on again or contact the factory
SCPU Fatal Error!	* SCPU circuit fatal error	* Contact the factory
Timer Slow Error Timer Fast Error	* System clock error	* Contact the factory
CPU or IRQ Error	* CPU or IRQ problem	* Power on again
Time or Bat Error	* System date time chip error	* Power on again or contact the factory
No Display, Erratic or Abnormal Operation	* Bad wiring connection	* Check wiring connections
Stroke Key - No Response	*Keypad locked or bad plug connection	* Enter the unlock password if the keypad is locked

Table 2. Error codes and solutions (during operation)

Code	M08 Display	Cause	Solution
*R	System Normal	* System normal	No errors
*J	SCPU Fatal Error	* Hardware defect	* Contact the factory
*I	Signal Not Detected	*Signal not detected. *Spacing is not correct between the transducers or not enough coupling compound applied to face of transducers. * Transducers installed improperly. * Scale is too thick. * New pipe liner.	* Attach transducer to the pipe and tighten it securely. Apply a plenty of coupling compound on transducer and pipe wall. * Remove any rust, scale, or loose paint from the pipe surface. Clean it with a file. * Check the initial parameter settings. * Remove the scale or change the scaled pipe section. Normally, it is possible to change a measurement location. The instrument may run properly at a new site with less scale . * Wait until liners solidified and saturated
*H	Low Signal Strength	* Low signal strength. * Cause refers to above-mentioned reasons.	* Solution refers to above-mentioned solutions.
*H	Poor Signal Quality	* Poor signal quality * All reasons are included in the above-mentioned causes.	* Solution refers to above-mentioned solutions.
*E	Current Loop over 20mA (No influence normally. Ignore it if no current output is being used.)	* 4-20mA current loop over 120% * Improper settings to current loop output.	* Check settings (refer to Window M56) and confirm if actual flow is too high.
*Q	Frequency output over set value No influence normally. Ignore it if no frequency output is being used.	* Frequency output over 120%. * Improper settings to frequency output or actual flow are too high.	* Check settings (refer to Window M66- M69) and confirm if the actual flow is too high.
*F	Refer to Table 1.	* Error in self-diagnoses during power on. * Permanent hardware error.	* Power on again; resolve it by the method listed in Table 1. If it is still a problem, contact the factory. * Contact the factory.
*G	Adjusting Gain>S1 Adjusting Gain>S2 Adjusting Gain>S3 Adjusting Gain>S4 (Display in WindowsM00,M01 ,M02,M03)	*Adjusting gain for normal measurement. *Stop in S1 or S2 and only switch between S1 and S2 indicates a poor wave form or low signal strength. All reasons may be included in above-mentioned items.	
*K	Pipe Empty.	* No fluid in pipe or settings incorrect.	

6. Frequently Asked Questions and Answers

Q: New pipe, high quality material, and all installation requirements met: why still no signal detected?

A: Check pipe parameter settings, installation method and wiring connections. Confirm if the coupling compound is applied adequately, the pipe is full of liquid, transducer spacing agrees with the screen readings and the transducers are installed in the right direction.

Q: Old pipe with heavy scale inside, no signal or poor signal detected: how can it be resolved?

A: 1. Check if the pipe is full of fluid.

2. Try the Z method for transducer installation (If the pipe is too close to a wall, or it is necessary to install the transducers on a vertical or inclined pipe with flow upwards instead of on a horizontal pipe) .

3. Carefully select a good pipe section and fully clean it, apply a wide band of coupling compound on each transducer face (bottom) and install the transducer properly.

4. Slowly and slightly move each transducer with respect to each other around the installation point until the maximum signal is detected. Be careful that the new installation location is free of scale inside the pipe and that the pipe is concentric (not distorted) so that the sound waves do not bounce outside of the proposed area. For pipe with thick scale inside or outside, try to clean the scale off, if it is accessible from the inside.

(Note: Sometimes this method might not work and sound wave transmission is not possible because of the a layer of scale between the transducers and pipe inside wall) .

Q: Why is there no CL (current loop) output?

A: Check if the desired current output mode is set in Window F56. See if the CL is powered off by "CL Off" settings. Open the electronics enclosure to inspect the hardware circuit.

Q: Why is the CL output abnormal?

A: Check to see if the desired current output mode is set in Window M54

Check to see if the maximum and minimum current values are set properly in Windows M55 and M56. Re-calibrate CL and verify it in Window M57.

Q: Why is the flow rate still displayed as zero while there is fluid obviously inside the pipe and a symbol of "R" displayed on the screen?

A: Check to see if "Set Zero" was carried out with fluid flowing inside the pipe (Refer to Window M42) . If it is confirmed, recover the factory default in Window M42.

Q: With a poor measurement site environment in the plant and the voltage and power supplies fluctuating widely, is the instrument really able to keep running 24 hours a day repeatedly without stopping and last for several years under such conditions?

A: AUF750 is designed to work with high reliability under such conditions. It is provided with an intelligent signal conditioning circuit and internal correction circuitry. It will work under strong interference conditions and is able to adjust itself with strong or weak sound waves. It will work in a wide band of voltage: 90~260 VAC or 8V~36V DC voltage.