



Operation Manual

MODEL 6TX

2-wire Isolated pH/ORP Transmitter

JENCO Electronics,ltd.

CONTENTS

INITIAL INSPECTION	2
INTRODUCTION	2
ASSEMBLY	3
PREPARATION	4
CONNECTING THE ELECTRODE	4
CONNECTING THE TEMPERATURE PROBE	5
POWER SUPPLY REQUIREMENTS	5
USING THE TRANSMITTER	8
DISPLAY	8
KEYPAD	9
MODES	10
pH CALIBRATION	11
First point pH calibration	11
Second point pH calibration	12
SETUP	13
Temperature Sensor type selection	13
Buffer set selection	13
Transmission mode selection	14
4mA Output rang setting	14
20mA Output rang setting	14
4-20mA ANALOG OUTPUT	15
ERROR DIAPLAYS	16
TROUBLESHOOTING	17
pH BUFFERS	18
SPECIFICATIONS	19
WARRANTY	20
RETURN OF ITEMS	20

INITIAL INSPECTION

Carefully unpack the instrument and accessories. Inspect for damages made in shipment. If any damage is found, notify your **Jenco** representative immediately. All packing materials should be saved until satisfactory operation is confirmed.

INTRODUCTION

The **6TX** pH/ORP Transmitter is a microprocessor-based instrument that is designed to be sturdy and user-friendly. It is capable of measuring pH, mV and temperature with large LCD display. It is assembled in a watertight 1/4 DIN case, and designed for laboratories and process control application.

The output of **6TX** transmitter is via the 2-wire DC power supply loop with input / output isolation to eliminate ground loops and ground voltage difference. Both the 4mA and 20mA output can be assigned to specific pH or ORP (mV) values, for a more refined output.

pH value is affected by temperature. You can select **ATC** (automatic temperature compensate) or **MAN** (manual temperature compensate) to compensate pH value. **6TX** transmitter accepts PT (PT1000 is commonly. And PT100 is available too, but it should be set by the manufacturer.), 3K Balco or 10K thermistor as temperature sensor for **ATC**.

6TX transmitter accepts 2 buffer sets (pH 4.01, **7.00**, 10.01) or (pH 4.00, **6.86**, 9.18) for pH calibration, and it has up to 2 points pH calibration.

6TX transmitter has a wide operation voltage range (from 12V to 36V DC).

Other features include electrode offset recognition, electrode slope recognition, electrode efficiency display, built in buffer coefficients, and auto-saving pH calibration values and setting parameters.

ASSEMBLY

Mounting procedure:

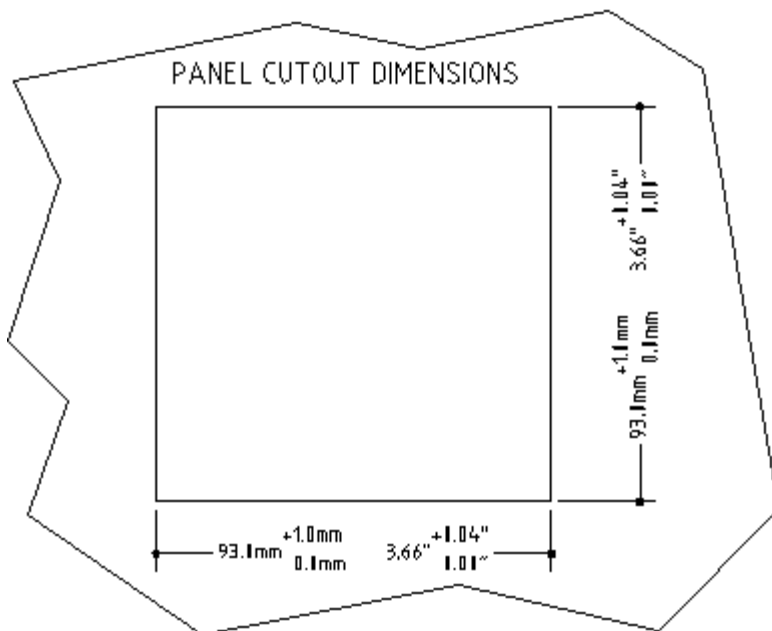

FIGURE 1

1. Make a cutout on any panel, with a thickness of **1/16 in. (1.5 mm) to 3/8 in. (9.5mm)**.
2. Remove the mounting assembly from the transmitter and insert the transmitter into the cutout.
3. Replace the mounting bracket assembly onto the transmitter and secure the transmitter to the mounting panel.

Note: *Install the transmitter in an area where vibrations and electromagnetic and radio frequency interference are minimized or absent.*

Keep the transmitter and sensor wiring at least one foot from high voltage conductors.

PREPARATION

Remove screws from the four corners at the back of the transmitter, and remove the back cover. Connectors should be exposed as following:

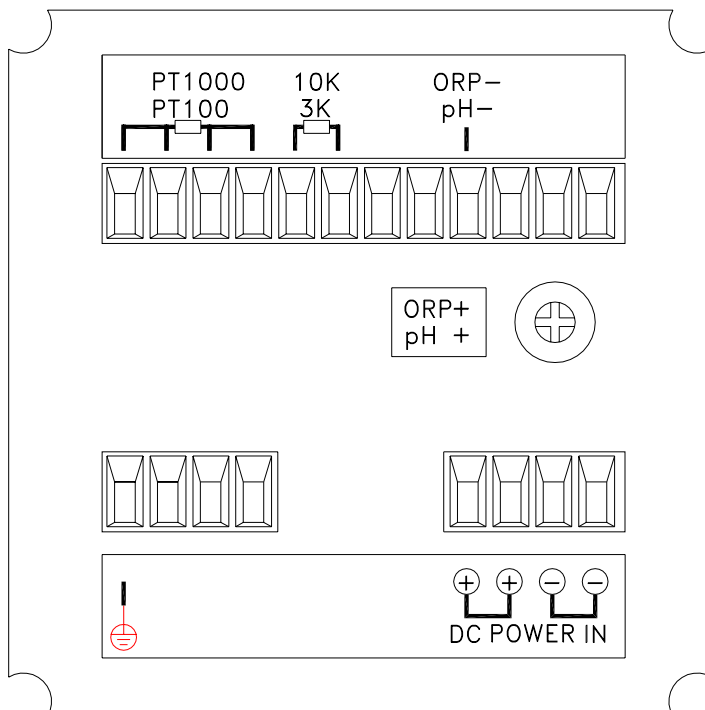

FIGURE 2

6TX transmitter case has two openings, one opening is for the power cable, and another opening is for the sensor cables, run all wires or cables through these two openings at first. Using a suitable screwdriver, loosen screws from the connectors. When inserting the wires, always hold connectors with the screws. After correctly connecting all the wires, please tighten the cord-grips and re-install the back cover.

CONNECTING THE ELECTRODE

6TX transmitter uses any standard pH/ORP electrode.

CONNECTING THE TEMPERATURE PROBE

For Automatic Temperature Compensation (**ATC**) for pH measuring, **6TX** transmitter requires a temperature probe. You can select one from PT, 3K Balco or 10K thermistor as temperature sensor for **ATC**.

6TX transmitter provides 2 terminals for connecting the 3K Balco or 10K thermistor temperature probe. And **6TX** transmitter provides 4 other terminals for connecting PT temperature probe that should have 4-wire configuration. If a 2-wire or 3-wire PT temperature probe is used, the wiring of probe should be connected specially.

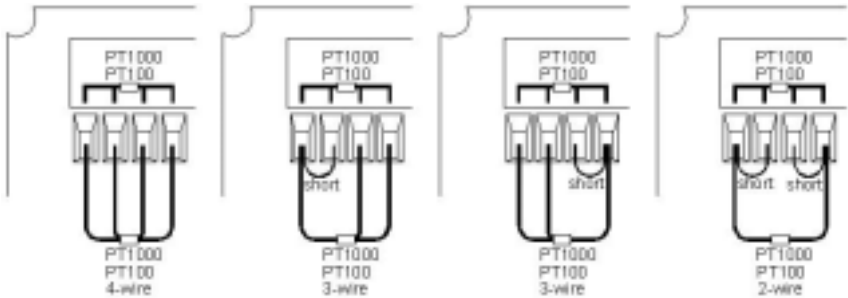

FIGURE 3

Note: Temperature probes should always combined with the pH probe.

POWER SUPPLY REQUIREMENTS

6TX transmitter requires a 12 to 36V DC power supply. The ideal work voltage is 24V DC. Other recorder or PLC may be connected in series. It is very easy to connect several transmitters in a system since this transmitter has two terminals for the positive polarity and the negative polarity of power supply.

Use twisted pair shielded cable for connection of the transmitter to the power supply and ground the shield at the power supply. For proper safety, the **EARTH GROUND** terminal should be grounded to a nearby source of electrically clean ground.

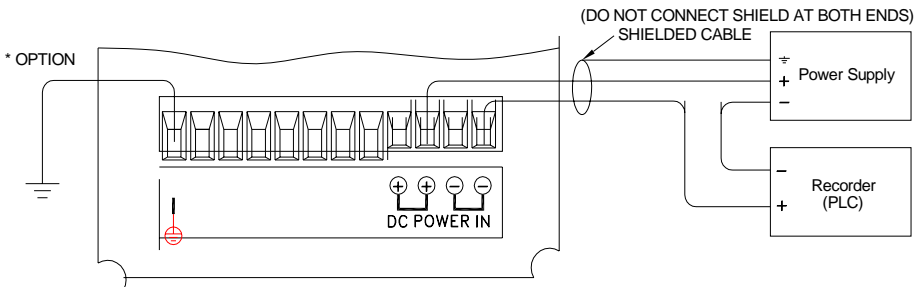

Operating with 1 transmitter

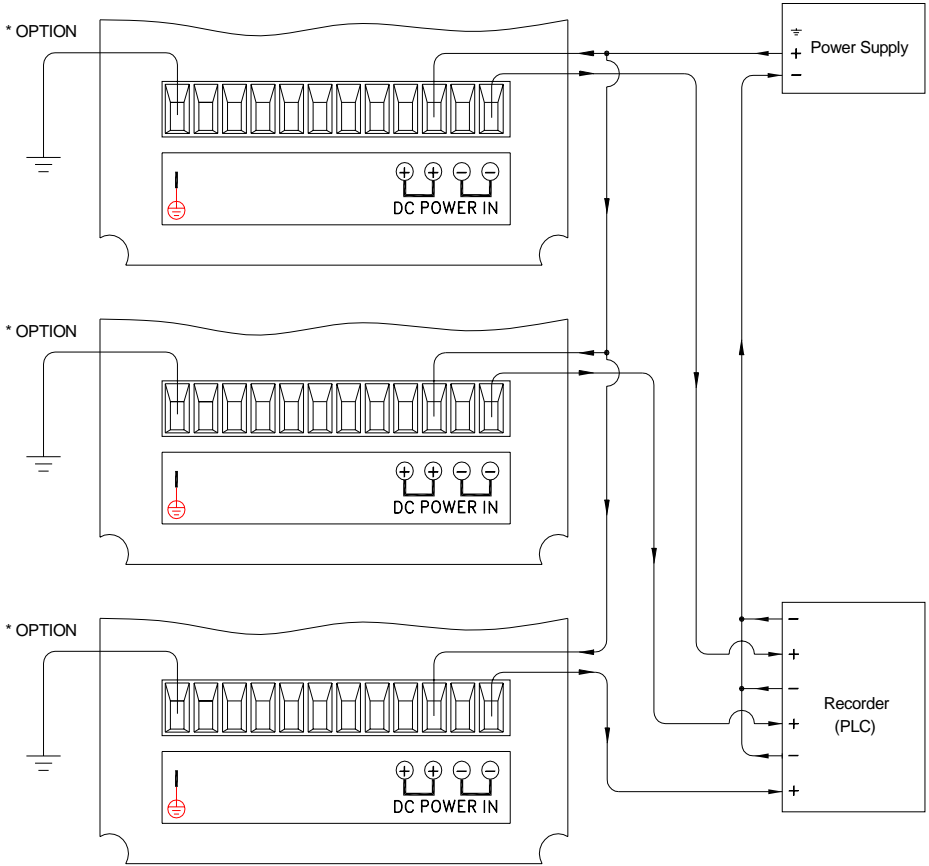

Operating with several transmitters

FIGURE 4

Note: For optimum EMI/RFI immunity the power supply cable should be shielded, power supply wiring or sensor cables should be enclosed in an earth-grounded metal conduit. Do not run power supply wiring or sensor cables in the same conduit or cable tray with AC power lines or with relay actuated signal cables. Keep power supply wiring and sensor cables at least 6 ft (2 m) away from heavy electrical equipment.

The maxim load, **R**, is determined by the following equation:

$$R = [\text{Voltage of power supply} - 12] / 21 \times 1000$$

The maxim load, **R**, includes the total loop resistance of the lead wires for the power supply.

When DC power supply is on, this transmitter will be on and ready for use.

USING THE TRANSMITTER

DISPLAY

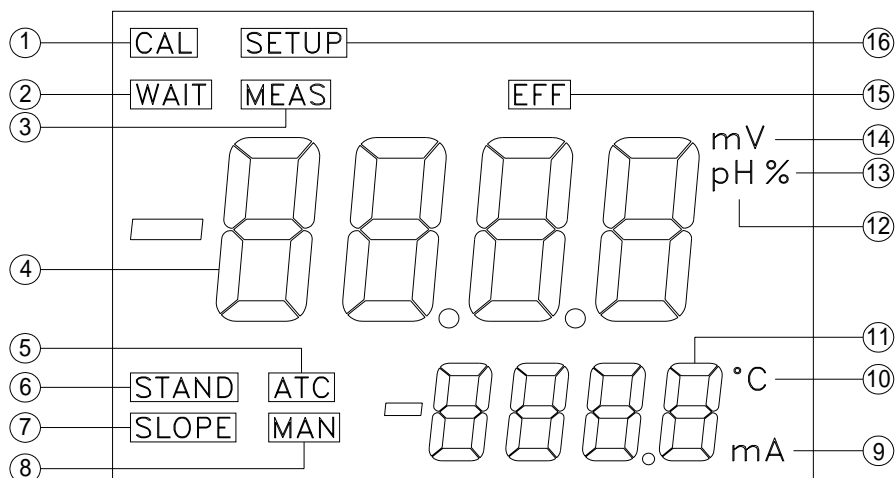

FIGURE 5

- | | |
|----------------------|-------------------------------|
| 1. CAL | : Calibration mode indicator. |
| 2. WAIT | : Waiting indicator. |
| 3. MEAS | : Measurement mode indicator. |
| 4. - 8 8.8.8 | : Main LCD display. |
| 5. ATC | : ATC mode indicator. |
| 6. STAND | : pH calibration indicator. |
| 7. SLOPE | : pH calibration indicator. |
| 8. MAN | : Manual mode indicator. |
| 9. mA | : mA unit. |
| 10. | : Temperature unit. |
| 11. - 8 8 8.8 | : Second LCD display. |
| 12. pH | : pH unit. |
| 13. % | : Percentage unit. |
| 14. mV | : mV unit. |
| 15. EFF | : Efficiency of pH electrode. |
| 16. SETUP | : Setup mode indicator. |

KEYPAD

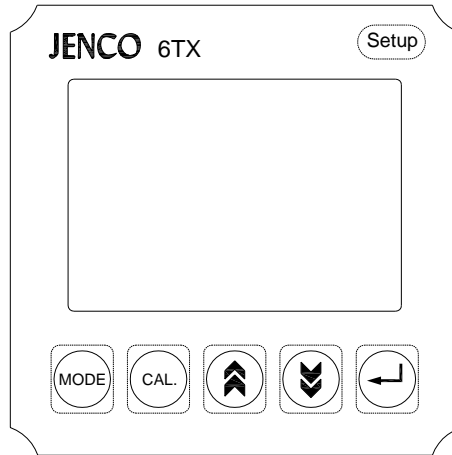

FIGURE 6

The 6-button keypad allows easy and quick operations of this transmitter.

Key	Function
MODE	During pH MEAS or mV MEAS mode, pressing MODE key will change MEAS mode. During pH CAL mode, pressing MODE key will exit pH calibration. During SETUP mode, pressing MODE key will go to the next step.
CAL	During pH MEAS mode, pressing CAL key to enter pH CAL mode. During pH CAL mode, after the first point or the second point pH calibration, pressing CAL key to recalibrate the current point again.
(UP)	To increment values or toggle between options during SETUP mode. To increment temperature value during MAN mode.
(DOWN)	To decrement values or toggle between options during SETUP mode. To decrement temperature value during MAN mode.
(ENTER)	To confirm and go to the next step during pH CAL mode. To confirm selections during SETUP mode.
Setup	During pH MEAS or mV MEAS mode, pressing Setup key to enter SETUP mode.

MODES

6TX transmitter has two measurement modes as following:

- 1.**pH MEAS** mode: a measurement of pH value with **MEAS** and **pH** indicators being on.
- 2.**mV MEAS** mode: a measurement of mV (ORP) value with **MEAS** and **mV** indicators being on.

6TX transmitter has two special modes as following:

- 1.**pH CAL** mode: pH calibration with **CAL** indicator being on.
- 2.**SETUP** mode: setting or customization the transmitter with **SETUP** indicator being on.

6TX transmitter has two transmission modes as following:

- 1.**pH transmission** mode: for pH transmission.
- 2.**ORP transmission** mode: for ORP transmission.

6TX transmitter has two temperature compensation modes as following:

- 1.**ATC** mode: the temperature probe should be connected.
- 2.**MAN** mode: the temperature probe should not be needed. The temperature sensor type should be assigned to **MAN**, you can input temperature value directly by pressing or keys during **pH MEAS** mode and **pH CAL** mode.

pH CALIBRATION

1-point or 2-point pH calibration is required for **6TX** transmitter.

There are two sets of pH buffer available for this transmitter: 4.01, **7.00**, 10.01pH and 4.00, **6.86**, 9.18pH.

Buffer set	7.00	6.86
First point buffer	7.00	6.86
Second point buffer	4.01 or 10.01	4.00 or 9.18

1. Rinse the pH electrode and ATC/Temp probe thoroughly with de-ionized water or a rinse solution. Blot excess liquid.
2. From **pH MEAS** mode, press **CAL** key to enter **pH CAL** mode. The transmitter will load default pH calibration value. The **CAL** indicator will be shown. The **STAND** indicator will start to flash.

*If you want to exit pH calibration, please press **MODE** key.*

First point pH calibration

3. Dip probes into the first point buffer, end of probes must be completely immersed into the buffer.

Press **ENTER** key to start the calibration. The **STAND** indicator will be shown. The **WAIT** indicator will start to flash.

4. When a stable reading is reached, the **WAIT** indicator will stop flashing and stay off. The **SLOPE** indicator will start to flash. Now the transmitter has been calibrated by 1-point.

Press **CAL** key to recalibrate the first point again, if you want.

*If you want only 1-point pH calibration for this transmitter, please press **MODE** key to exit pH calibration. Otherwise, please go on the next steps.*

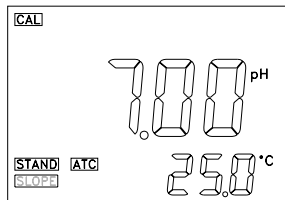
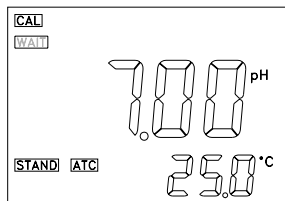
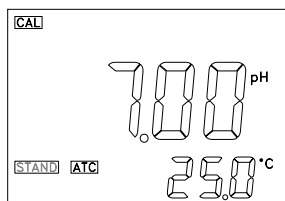

5. Rinse probes thoroughly with de-ionized water or a rinse solution. Blot excess liquid.

Second point pH calibration

6. Dip probes into the second point buffer, end of probes must be completely immersed into the buffer.

Press **ENTER** key to start the calibration. The **SLOPE** indicator will be shown. The **WAIT** indicator will start to flash.

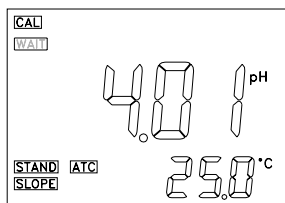

7. When a stable reading is reached, the **WAIT** indicator will stop flashing and stay off. Now the transmitter has been calibrated by 2-point.

Press **CAL** key to recalibrate the second point again, if you want.

Press **ENTER** key to confirm this calibration, and the transmitter is calibrated by 2-point.

After the primary display shows the **EFF**iciency of the pH electrode about 5 seconds, the transmitter will exit pH calibration and go to **pH MEAS** mode.

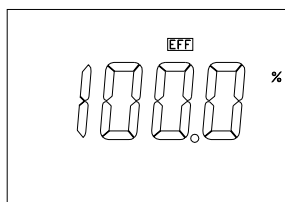
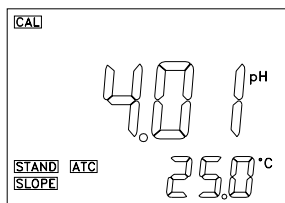

The equation for the **EFF**iciency of the pH electrode is:

$$\text{EFFiciency} = (\text{new slope} / \text{ideal slope}) \times 100 \%$$

Note: It was recommended that you should use a new pH electrode if the **EFF**iciency of old pH electrode is lower than 80% or higher than 120%.

After 1-point or 2-point pH calibration, rinse electrode and proceed with pH measurements.

SETUP

The **SETUP** mode let you customize your **6TX** transmitter.

1. During **pH MEAS** mode or **mV MEAS** mode, press **Setup** key to enter **SETUP** mode. **Note:** During **SETUP** mode, press **MODE** key to go to the next step.

Temperature Sensor type selection

2. The transmitter will show temperature sensor type.

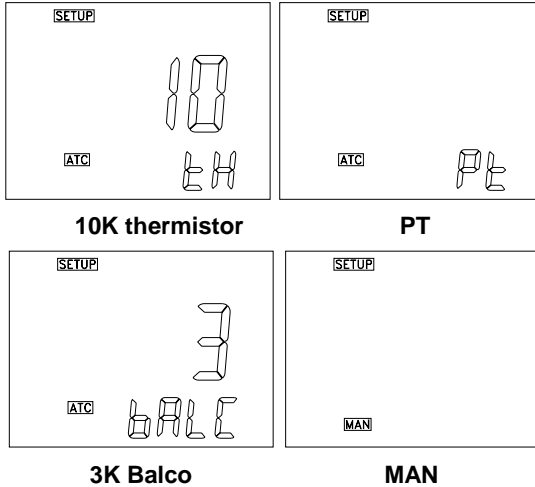

Press **←** or **→** keys to choose your temperature probe type from **10K thermistor**, **PT**, **3K Balco** or **MAN**.

Press **ENTER** key to confirm your selection.

Buffer set selection

3. The primary display will show buffer set **7.00** or **6.86**.

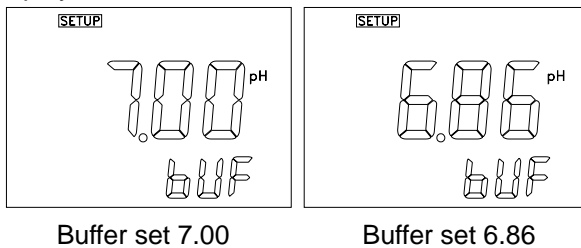

Press **←** or **→** to choose your buffer set, either **7.00** or **6.86**.

Press **ENTER** key to confirm your selection.

Transmission mode selection

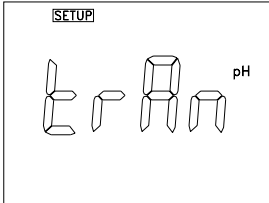

4. The transmitter will show transmission mode.

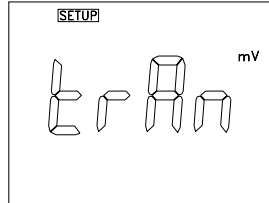

pH transmission



ORP transmission



Press  or  keys to choose your transmission mode, either pH transmission or ORP transmission.

Press **ENTER** key to confirm your selection.

4mA Output range setting

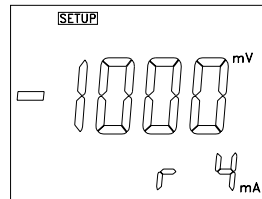
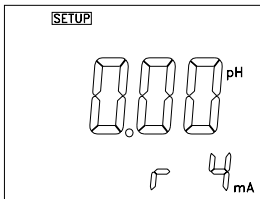
5. Upper display shows pH value or mV value while lower display shows r 4mA.





Assign pH value or mV value to 4 mA output. Press  or  keys to change pH value or mV value.

Press **ENTER** key to accept the value.

20mA Output range setting

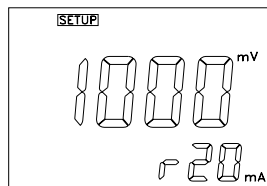
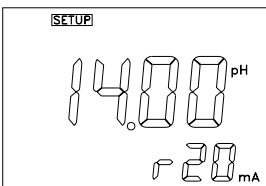
6. Upper display shows pH value or mV value while lower display shows r20 mA.



Assign pH value or mV value to 20 mA output. Press  or  keys to change pH value or mV value.

Press **ENTER** key to accept the value and exit setup.

4-20mA ANALOG OUTPUT

The 4-20mA analog output is via 2-wire power supply loop; it depends on the transmission mode, the pH (or mV) setting value for 4mA output, the pH (or mV) setting value for 20mA output, and the known pH (or mV) value.

The 4-20mA analog output is based on the following equation:

$$\text{mA(output)} = 4\text{mA} + 16\text{mA} \times (K_v - r_{4\text{mA}}) / (r_{20\text{mA}} - r_{4\text{mA}})$$

mA(output) = 4-20mA analog output

K_v = Known value of pH (or mV)

r_{4mA} = pH (or mV) setting value for 4mA output

r_{20mA} = pH (or mV) setting value for 20mA output

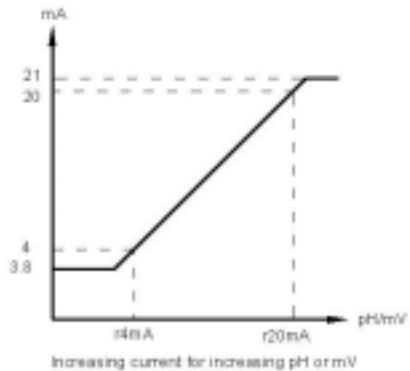
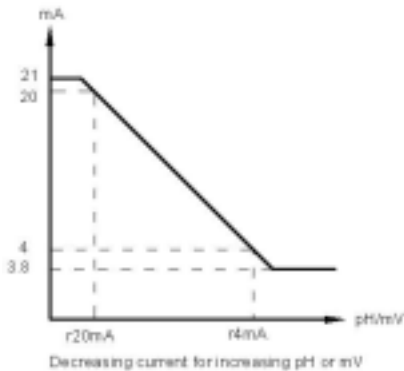

- Note:**
1. The range of pH setting value for 4mA output, **r_{4mA}**, and pH setting value for 20mA output, **r_{20mA}**, is from 0.00pH to 14.00pH.
 2. The range of mV setting value for 4mA output, **r_{4mA}**, and mV setting value for 20mA output, **r_{20mA}**, is from -1000mV to 1000mV.
 3. pH (mV) setting value for 4mA output, **r_{4mA}**, and pH (mV) setting value for 20mA output, **r_{20mA}**, should not be equal.
 4. pH (mV) setting value for 4mA output, **r_{4mA}**, and pH (mV) setting value for 20mA output, **r_{20mA}**, should be assigned at **SETUP** process.
 5. Under range current output is 3.80mA, over range current output is 21.00mA.

ERROR DIAPLAYS

Indication	Cause	Solution
In the first point pH calibration, it displays OuEr .	a) Buffer temperature is out of the 0 to 60 range; b) Buffer is not correct; c) pH electrode offset is greater than ± 90 mV.	a) Cool / Heat Buffer as needed; b) Replace buffer; c) Replace pH electrode.
In the second point pH calibration, it displays OuEr .	a) Buffer temperature is out of the 0 to 60 range; b) Buffer is not correct; c) PH electrode slope is off by more than $\pm 30\%$ of the ideal slope.	a) Cool / Heat Buffer as needed; b) Replace buffer; c) Replace pH electrode.
In pH measurement, it displays OuEr / Undr .	a) pH value is out of the -2.00 pH to 16.00 pH range; b) Loose connections.	a) Bring solution to acceptable reading; b) Check cables are making good contact.
In mV measurement, it displays OuEr / Undr .	a) mV value is out of the -1000 mV to 1000 mV range; b) Loose connections.	a) Bring solution to acceptable reading; b) Check cables are making good contact.
In Temperature measurement, it displays OuEr / Undr .	a) Temperature is out of the -10.0 to 120.0 range; b) Improper attachment of temperature probe; c) Temperature probe cable connection has broken or short; d) Improper setting of temperature probe type.	a) Cool / Heat solution as needed; b) Check that the temperature probe connects properly to the transmitter; c) Replace the temperature sensor; d) Correct setting of temperature probe type.

TROUBLESHOOTING

Problem	Cause	Solution
Power on but no display.	a) Loose connections; b) Cables not in correct polarity (+ and - position).	a) Check cables are making good contact; b) Re-wire loop cables with correct polarity.
Unstable readings.	a) Air bubbles in probe; b) Dirty probe; c) Probe not deep enough in solution; d) External noise pickup or induction caused by nearby electric motor.	a) Tap probe to remove bubbles; b) Clean the probe and re-calibrate; c) Make sure solution entirely covers the probe sensors; d) Move or switch off interfering motor.
Slow response.	Dirty / Oily electrode.	Clean electrode.

pH BUFFERS

The temperature coefficient of pH calibration buffers 4.00, 4.01, **6.86**, **7.00**, 9.18 and 10.01 are stored inside the instrument. The buffers used to calibrate the instrument must exhibit the same temperature characteristics as the stored values.

Temperature coefficient of the pH buffers

	4.00	6.86	9.18	4.01	7.00	10.01
0	4.01	6.98	9.46	4.01	7.11	10.32
5	4.00	6.95	9.39	4.01	7.08	10.25
10	4.00	6.92	9.33	4.00	7.06	10.18
15	4.00	6.90	9.28	4.00	7.03	10.12
20	4.00	6.88	9.23	4.00	7.01	10.06
25	4.00	6.86	9.18	4.01	7.00	10.01
30	4.01	6.85	9.14	4.01	6.98	9.97
35	4.02	6.84	9.10	4.02	6.98	9.93
40	4.03	6.84	9.07	4.03	6.97	9.89
45	4.04	6.83	9.04	4.04	6.97	9.86
50	4.06	6.83	9.02	4.06	6.97	9.83
55	4.07	6.83	8.99	4.08	6.97	9.80
60	4.09	6.84	8.97	4.10	6.98	9.78

Note: *The actual reading of the instrument can differ from the values shown by ± 0.01 pH.*

SPECIFICATIONS

pH Range	-2.00 to 16.00 pH
pH Resolution	0.01 pH
pH Accuracy	±0.01 pH
No. Of pH Calibration Points	Up to 2 points
pH Buffer	(pH 4.01, 7.00, 10.01) or (pH 4.00, 6.86, 9.18)
PH Electrode Offset recognition	±90mV
pH Electrode Slope recognition	±30%
Input Impedance	>10 ¹²
mV Range	-1000 to +1000 mV
mV Resolution	1 mV
mV Accuracy	±1 mV
Temperature Range	-10.0 to 120.0 °C
Temperature Resolution	0.1 °C
Temperature Accuracy	±0.3°C
Temperature Sensor (for ATC)	10K thermistor , PT, 3K Balco
Temperature Compensation	ATC / MAN
Signal Output	4 to 20mA
Under/Over range current output	3.80mA / 21.0 0mA
Power Requirements	24V DC (12V to 36V DC)
Dimension	¼ DIN, depth 148mm

WARRANTY

Jenco Instruments, Ltd. warrants this meter to be free from significant deviations in material and workmanship for a period of 1 year from date of purchase. Probes are warranted for 6 months. If repair or adjustment is necessary and has not been the result of abuse or misuse, within the warranty period, please return-freight-prepaid and the correction of the defect will be made without charge. If you purchased the item from our **Jenco** distributors and it is under warranty, please contact them to notify us of the situation. **Jenco** Service Department alone will determine if the product problem is due to deviations or customer misuse.

Out-of –warranty products will be repaired on a charge basis.

RETURN OF ITEMS

Authorization must be obtained from one of our representatives before returning items for any reason. When applying for authorization, please have the model and serial number handy, including data regarding the reason for return. For your protection, items must be carefully packed to prevent damage in shipment and insured against possible damage or loss. **Jenco** will not be responsible for damage resulting from careless or insufficient packing. A fee will be charged on all unauthorized returns.

NOTE: *Jenco Instruments, Inc. reserves the right to make improvements in design, construction, and appearance of our products without notice.*

For more information on our products, please contact your nearest distributor or visit our website listed below:

JENCO INSTRUMENTS, INC.

7968 Arjons Drive, Suite C

San Diego, CA 92126 USA

TEL: 858-578-2828 FAX: 858-578-2886

E-MAIL: info@jencoi.com or sales@jencoi.com

Homepage: <http://www.jencoi.com/>

JENCO ELECTRONICS, LTD.

PO. BOX 117, JHONG JHENG RD, LINKOU SHIANG,

TAIPEI HSIEN, TAIWAN. R.O.C.

TEL: 02 601-6191 FAX: 02 601-7206

E-MAIL: jencoe@ms2.hinet.net

Homepage: <http://www.jenco.com.cn>

SHANGHAI JENCO ELECTRONICS, LTD.

18 Wang Dong Zhong Road

Sijing Town, Songjiang

SHANGHAI, CHINA

TEL: (86-021)5761-9599 FAX: (86-021)5761-9598

E-MAIL: jenco@public.sta.net.cn

Homepage: <http://www.jenco.com.cn>

DISTRIBUTED BY:

使用说明书（英文）

机型	6TX	编制人	豆林奇	编制日期	2007-07-03
文件编号	K6TX-02	修改人	杨启娜	修改日期	2007-8-2
版本号	03	核准人		核准日期	

070802：修改接线图