

OPERATION MANUAL

JENCO MODEL 6313 MICROCOMPUTER BASED pH / ORP and Temperature CONTROLLER

JENCO INSTRUMENTS, INC.

7968 ARJONS DR., SUITE C

SAN DIEGO, CA 92126 USA

TEL: (858) 578-2828

FAX: (858) 578-2886

E-MAIL: jencoinfo@jencoi.com

sales@jencoi.com

JENCO ELECTRONICS, LTD.

4F., NO. 80, SONGDE RD., XINYI

DIST., TAIPEI CITY 110, TAIWAN

TEL: (886-2) 2345-6188

FAX: (886-2) 2345-6791

E-MAIL: sales@jenco.com.tw

SHANGHAI JENCO ELECTRONICS, LTD.

18 WANG DONG ZHONG ROAD SIJING TOWN,

SONGJIANG SHANGHAI, CHINA

TEL: 86-21-5761-9599

FAX: 86-21-5761-9598

E-MAIL: Sales@jenco.com.cn

CONTENTS	Page
I. INITIAL INSPECTION and ASSEMBLY	2
II. GENERAL INTRODUCTION	3
III.USING THE JENCO MODEL 6313	4
A.FRONT PANEL	4
B.LCD SCREEN	6
C.REAR CONNECTORS	8
D.TURNING ON/OFF THE INSTRUMENT	9
IV. MODEL 6313 MODES	10
A.MAIN DISPLAY MODE	10
B.CALIBRATION/SETTING MODE	11
a. PASSWORD CHECK screen.	11
b. CALIBRATION/ SETTING SELECT screen	12
1. ACTIVE "pH"	12
i. TEMPERATURE PROBE SELECT	12
ii. pH BUFFER I (STAND) SELECT	13
iii. pH BUFFER II SELECT	13
iv. STAND CALIBRATION	13
v. SLOPE CALIBRATION	14
vi. EFFICIENCY information	14
Step by Step pH calibration	14
vii. 4mA SETTING	17
viii. 20mA SETTING	17
ix. RELAY-1, RELAY-2 SETTING	17
x. PASSWORD SETTING	18
2. ACTIVE "ABS mV"	18
i. TEMPERATURE PROBE SELECT	18
ii. 4mA SETTING	19
iii. 20mA SETTING	19
iv.RELAY-1,RELAY-2 SETTING	19
v. PASSWORD SETTING	20
3. ACTIVE "REL mV"	20
i. TEMPERATURE PROBE SELECT	20
ii. OFFSET SETTING	21
iii. 4mA SETTING	21
iv. 20mA SETTING	21
v RELAY-1, RELAY-2 SETTING	22
vi. PASSWORD SETTING	22
V. CONTROLLING THE RELAYS	22
A.ISOLATION VOLTAGE	22
B.OUTPUT LOAD	23
C.RELAY ACTION, RELAY SETPOINT & HYSTERESIS VALUE	23
VII. 4-20 mA OUTPUT	24
A.ISOLATION VOLTAGE	24
B.OUTPUT LOAD	24
C.LINEAR ANALOG OUTPUT	24
VIII.ERROR DISPLAYS AND TROUBLESHOOTING	25
IX. pH BUFFERS	27
X. SPECIFICATIONS	28
XI. WARRANTY	29
XII.KEYBOARD FLOWCHARTS	30
A.pH MODE	30
B."ABS mV" MODE	31
C."REL mV" MODE	32

I. INITIAL INSPECTION and ASSEMBLY

Carefully unpack the instrument and accessories. Inspect for damages made in shipment. If any damage is found, notify your Jenco representative immediately. All packing materials should be saved until satisfactory operation is confirmed.

MOUNTING PROCEDURE

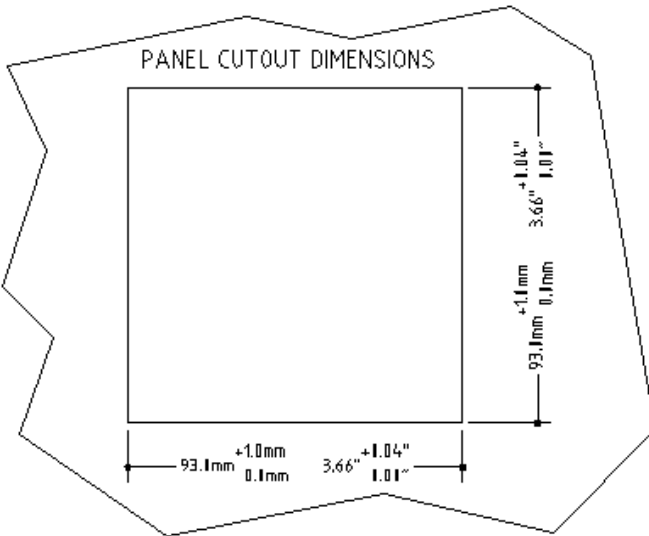

1. Make a cutout on any panel, with a thickness of **1/16 in. (1.5 mm) to 3/8 in. (9.5mm)**.

2. Remove the mounting assembly from the controller and insert the controller into the cutout.

3. Replace the mounting bracket

assembly onto the controller and secure the controller to the mounting panel.

Warning:

If the equipment is used in a manner not specified by the manufacturer, the protection provided by the equipment may be impaired.

Cleaning the instrument:

1. Be sure to remove the power before attempting to clean the meter.
2. Use a lint free cloth and clean water or neutral detergent.
3. Wipe the outer surface of the instrument only.
4. Wipe-dry the instrument before powering again.

II. GENERAL INTRODUCTION

The Jenco **Model 6313 (pH/ORP and Temperature) controller** is a rugged microprocessor based instrument assembled in a watertight $\frac{1}{4}$ DIN case, designed for use in laboratories and process control applications.

The system simultaneously displays pH or ORP, Temperature and relay status in one large LCD screen.

The model 6313 microprocessor performs a self-diagnostic routine every time you turn on the unit providing you with basic information on the stability of the instrument.

The model 6313 is equipped with 2 control relays. All control relays are programmable and hysteresis driven. The system also has an **isolated 4-20mA** analog output, offset and span configurable for the pH or ORP display.

III. USING THE JENCO MODEL 6313

A. FRONT PANEL

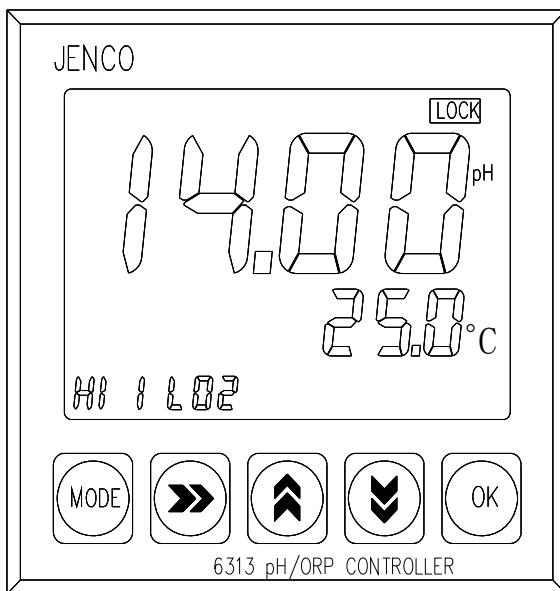

1. The [MODE] key.

1a. In **MAIN** display mode this key will switch the display from pH, ORP absolute mV, ORP relative mV, CAL and back to pH display again.

1b. In the **PASSWORD CHECK** mode, pressing the [MODE] key for two seconds will bypass the **PASSWORD CHECK** and *just* let the user continue. Just press the [OK] key to view all control settings but the user will not be able to change any setting.

1c. After entering "CAL " mode, pressing the [MODE] key for two seconds will leave the control setting and return the user to the **MAIN** display mode.

2. The [▶] **RIGHT** key.

2a. In CALibration mode where the user can change the settings and the setting is in decade number format, pressing this key will select the next digit.

2b. In **pH Buffer I Calibration (STAND)** if the user wants to skip electrode calibration, pressing this key will skip pH calibration but will still display the last calibration's EFFICIENCY for about four seconds before continuing to 4mA setting.

2c. In **pH Buffer II Calibration (SLOPE)** if the user wants to skip calibration, pressing this key will skip pH slope calibration (single point calibration only) but will still display the electrode ideal EFFICIENCY (100%) for about four seconds before continuing to 4mA setting.

3. The [▲] **UP** key.

In CALibration mode where the user can change the settings, this key will show the next possible option. If in decade number format this key will *increment* the digit.

4. The [▼] **DOWN** key.

4a. In CALibration mode where the user can change the settings, this key will show the next possible option. If in decade number format this key will *decrement* the digit.

4b. During **pH Buffer Calibration**, the user can press this key to repeat the buffer calibration.

5. The [OK] key.

5a. In any mode where the user can change the settings, this key will save the new settings. If no change has been made then pressing this key will just move the user to the next setting.

5b. If the unit is password locked then continue pressing this key will just move the user to view the next setting.

B. LCD SCREEN

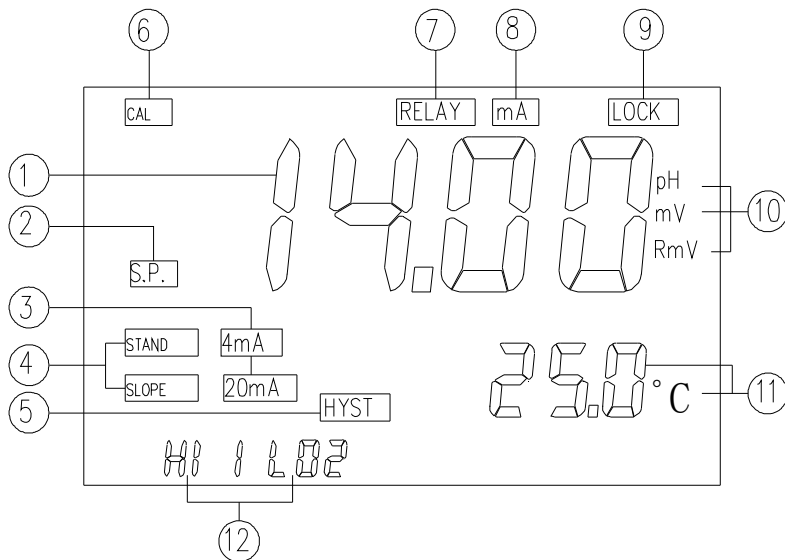

1. MAJOR LCD DISPLAY

2. **S.P.** annunciator- Set Point, this will turn ON while changing /viewing the **RELAY 1- RELAY 2** settings.

3. **4mA** & **20mA** annunciators - the respective annunciator will turn ON while in the 4 mA or 20 mA setting mode.

4. **STAND** & **SLOPE** annunciators - the respective annunciator will BLINK before Buffer 1 or Buffer 2 calibration. The respective annunciator will stay ON while BUFFER 1 or BUFFER 2 is being calibrated.

5. **HYST** annunciator - **HYSTERESIS**, this annunciator will turn ON while changing/viewing the **RELAY 1- RELAY 2** settings. This annunciator indicates that the value at the **MINOR LCD DISPLAY** is the hysteresis value.

6. **CAL** annunciator - this annunciator will turn ON if the user is not in **MAIN** display mode.

7. **RELAY** annunciator - this annunciator will turn ON if the user is in **RELAY1 - RELAY2** settings.

8. **mA** annunciator - this annunciator will turn ON if the user is in **4mA** or **20mA** setting.

9. **LOCK** annunciator - this annunciator will turn ON if the unit **PASSWORD LOCKED**.

10. **pH, mV, RmV** annunciators - this annunciators will indicate the unit of **MAJOR LCD DISPLAY**.

11. **LCD MINOR DISPLAY**

In **MAIN** mode, the temperature will be displayed here with the centigrade unit (°C).

In **CALibration** mode at **Relay1-Relay2** settings, the hysteresis value will be displayed here without any unit.

12. **HI?/LO?** annunciators - **HI?** or **LO?** indicates relay action and relay number. ("?" mark is the relay number.)

C. REAR CONNECTORS

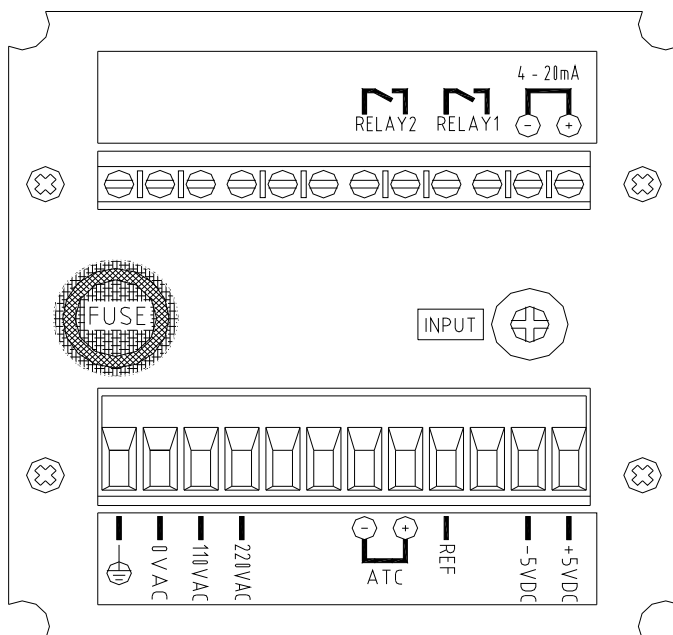

Before connecting the probes, relays, analog output and power cord be sure that you are inserting to the right terminal as shown above. Remember that the unit is ON once the user plugs in the power cord to an AC power supply.

1. Connect the AC line to the rear of the instrument. The model 6313 can be used with 115 or 230VAC 50/60 Hz. Power consumption is 6 watts. Make sure the **EARTH** connector is connected to the earth lead of the AC power line.
2. Connect the proper load to the output relays. **Make sure that the load does not exceed the relay rating, 5Amp at 110VAC and 2.5Amp at 220 VAC.**
3. Set the proper load to the 4-20mA-output connector. Make sure that the load impedance is less than 500 Ohms.
4. A **+5VDC** and **-5VDC** (max 20mA for each) output to provide excitation voltage for pH/ORP pre-amplifier only.

CAUTION:

- 1. MAKE SURE THAT THE POWER IS UNPLUGGED BEFORE WIRING YOUR PROBES, RELAY ETC.**
- 2. MAKE SURE YOU CONNECT THE AC POWER CORD TO THE CORRECT AC TERMINALS. CONNECTING INCORRECTLY MAY DAMAGE THE UNIT PERMANENTLY.**

D. TURNING ON/OFF THE INSTRUMENT

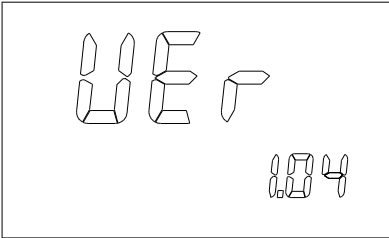

By just plugging the unit to a correct AC voltage the unit will be ready for use. There is no Power key so unplugging or plugging the unit will turn OFF or turn ON the unit respectively.

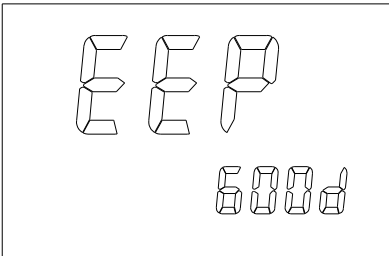

After the unit is turned on, the unit will display the software version number ("Ver"=Version) then it will perform some basic self-diagnostics ("EEP" = EEPROM Check, "RO-" = ROM Check & "RA-" = RAM Check) and will display "GOOD" or "bAd".

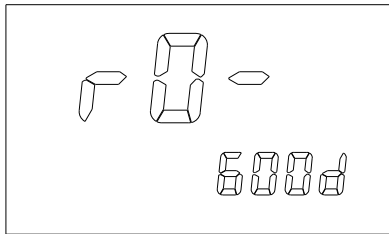

If you received any "bAd" messages turn OFF the unit and turn it ON again. (See **VIII. ERROR DISPLAYS AND TROUBLESHOOTING**).

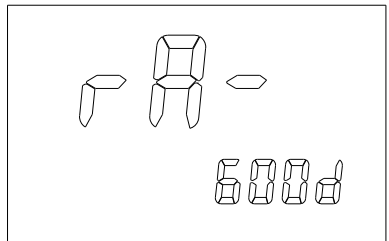

If the message persists then you might need to call your distributor. (See **XI. WARRANTY**).

After the self-diagnostic is complete the temperature will be displayed on the lowest part of the screen and you are ready to make pH / ORP / Temperature calibration or measurements. Just immerse the probes half way to the liquid. If possible do not allow the probes to touch any solid object in the solution.

There should be no air bubbles around the probes either. Shaking or moving the probes vigorously before recording any measurement will dislodge any bubbles formed in the probes.

IV. MODEL 6313 MODES

A. MAIN DISPLAY MODE

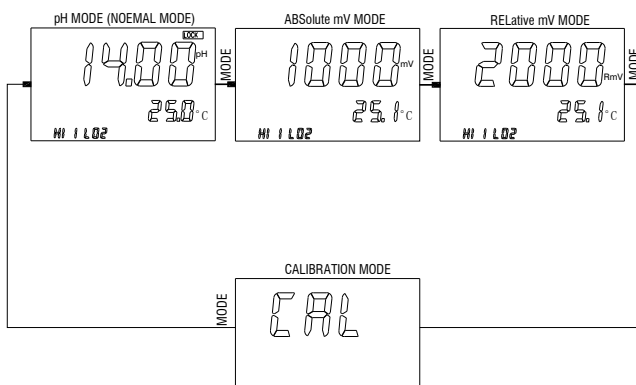

Turning ON the unit will always display **MAIN** display mode.

This instrument is designed to provide 4 distinct measurements:

1. **Temperature** - current temperature of the solution, which is always displayed.
2. **pH** - the degree of acidity or alkalinity of the solution (with automatic temperature compensation).
3. **ORP-mV** - a measurement of absolute ORP mV.
4. **ORP-RmV** - a measurement of relative ORP mV. The **OFFSET** value at the **ORP CALIBRATION** page will be added to the ORP absolute value to display the ORP relative value.

Pressing [MODE] in MAIN display mode will cycle the display from the four modes above.

B. CALIBRATION/SETTING MODE

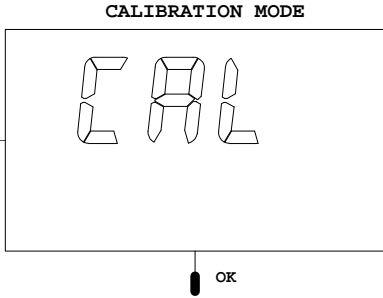

Pressing the [OK] key at the CAL mode will bring-up the PASSWORD CHECK display if the unit is LOCKED. If the unit is not locked, the unit will skip the PASSWORD CHECK screen and go directly to CALIBRATION SELECT screen.

a. PASSWORD CHECK screen.

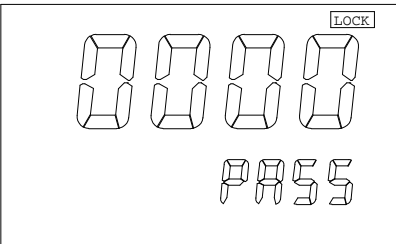

You will only see this screen if the unit is LOCKED. To change any settings or calibration you need to unlock the system to remove the "LOCK" message. You can use [▲], [▼], [▶] or [OK] keys to enter the correct 4-digit number on the

number input. The relays and analog out will be **FROZEN** (control relays and current output will not be updated even if the input is changing). The user can opt to view all the screens of **CALIBRATION/SETTING mode** even if the system is LOCKED, by just pressing the [MODE] key for about two seconds on this screen. If the unit is LOCKED when going to **CALIBRATION /SETTING mode**, viewing the settings will not affect the function of the relays and the current output.

CAUTION: *If the unit is UNLOCKED then every time the user enters the Calibration/Setting mode the relays and analog out will be FROZEN (control relays and current output will not be updated even if the input is changing).*

b. CALIBRATION/ SETTING SELECT screen

This screen will let the user select only one (pH, ABS. mV or REL. mV).

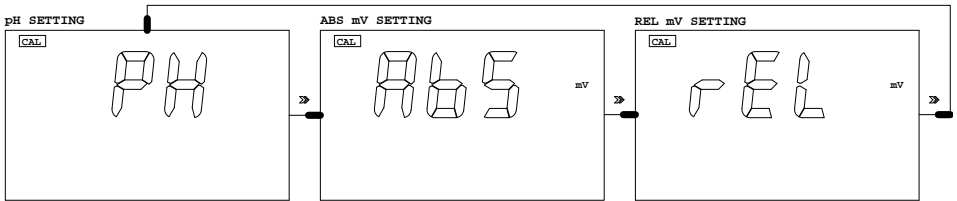

mV) mode that will control the relay1 - relay4 and mA output. This screen will always default to the last CALIBRATION/ SETTING SELECT you chose, so for most application you don't need to change this selection once you decide what reading to use. If you need to change the CALIBRATION/ SETTING SELECT, press the [▶] RIGHT key to choose your active reading then press [OK] to save your new selection and the unit will display the Temperature probe select screen. If the unit is LOCKED the user will not be able to change the setting here.

1. ACTIVE "pH"

If the user selected "AbS" or "rEL" please see the next section "2. ACTIVE "ABS" or "3. ACTIVE "REL" respectively.

i. TEMPERATURE PROBE SELECT screen

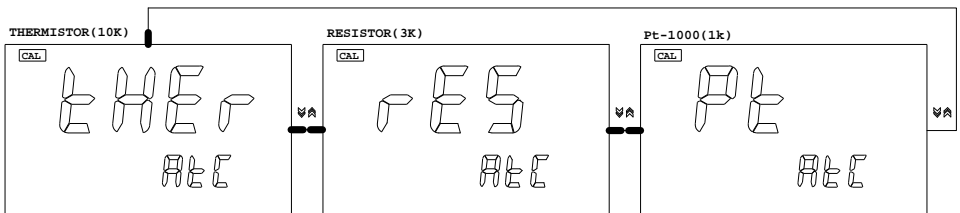

This screen will let the user select what temperature probe (10KΩ thermistor, Balco 3KΩ resistor or RTD pt-1000) the user will use. This screen will always default to the last temperature probe the user

selected. For most application the user will only use one kind of temperature probe so the user don't need to change this selection once you select the correct temperature probe. If the user needs to change the temperature probe type, press the [▲] or [▼] keys to change the temperature probe type, press the [▲] or [▼] keys to choose your temperature probe then press [OK] to save your new selection. The next two steps are for pH buffer select.

ii. pH BUFFER I (STAND) SELECT screen

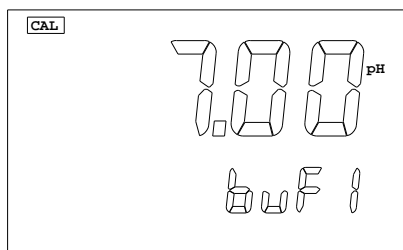

This screen selects the buffer for standardization calibration. The user can select "7.00pH" or "6.86pH". Press the [▲] or [▼] keys to select the buffer then the [OK] key to save your selection.

iii. pH BUFFER II (SLOPE) SELECT screen

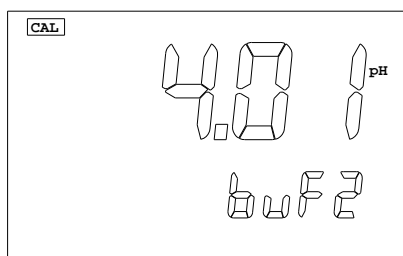

This screen selects the buffer for slope calibration. The user can select "1.68pH", "4.00pH", "4.01pH", "9.18pH", "10.01pH" or "12.46pH". Press the [▲] or [▼] keys to select the buffer then the [OK] key to save your selection. The next two steps

are for actual pH electrode calibration.

iv. STAND CALIBRATION screen

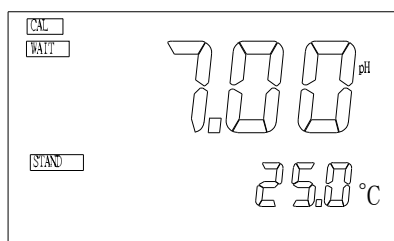

This is the actual pH calibration. The initial display will be the chosen buffer for pH BUFFER I SELECT. The "STAND" annunciator will blink indicating the unit is waiting for the user to start the calibration. Put the cleaned electrode and

temperature probe in buffer I. Press the [OK] key will start the calibration. For Detailed instructions please see **Step-by-Step pH Calibration (step 7)** on the next page.

v. SLOPE CALIBRATION screen

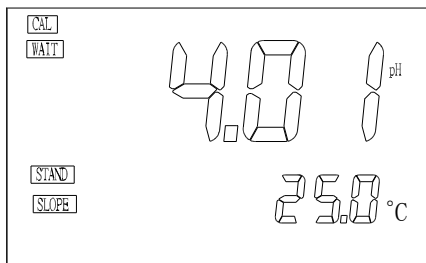

After finishing the Buffer I calibration the unit will move to this screen. The initial display will be the chosen buffer for **pH BUFFER II SELECT**. The "SLOPE" annunciator will blink indicating that the unit is waiting for the user to continue the calibration. Put the

cleaned electrode and temperature probe in buffer II. Pressing the [OK] key will start the calibration. For detailed instructions please see **Step-by-Step pH Calibration** on the next page.

vi. EFFICIENCY information screen

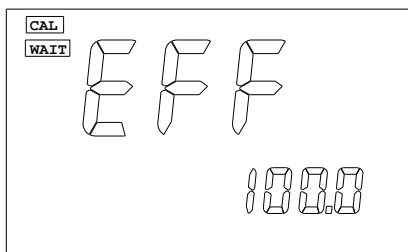

This screen will display the efficiency of the pH electrode from its last calibration. This screen is for user information only and will automatically change to the 4mA setting after 4 seconds.

The equation of Efficiency is:

$$\text{Efficiency} = (\text{new slope} / \text{ideal slope}) \times 100\%.$$

We recommend that you use a new electrode, if the electrode efficiency is lower than 80%.

Step by Step pH calibration

1. From the MAIN display mode, press the [MODE] key to go to "CAL" screen then press [OK].
2. If the unit is LOCKED, remove the LOCK display first.
3. Select "pH" at the CALIBRATION/ SELECT screen. This will also set the RELAYS and ANALOG OUT to be controlled by the pH reading.
4. Select the correct temperature probe at TEMPERATURE PROBE SELECT screen.
5. Select the correct buffer at pH BUFFER I SELECT screen.
6. Select the correct buffer at pH BUFFER II SELECT screen.
7. Clean the pH electrode and temperature probe with de-ionized or distilled water.
8. Place the pH electrode and Temperature probe into buffer 1.
9. Press the [OK] key to start the STANDardization calibration. A "WAIT" message will blink indicating that the instrument is waiting for a stable reading. The display will be locked to the buffer value corresponding to the temperature of buffer 1 (See chapter IX. pH Buffers). When a stable reading is reached, the unit will blink a "SAVE" message at MINOR LCD display.
10. Press the [OK] key to save the STAND calibration and prepare to do a SLOPE calibration OR press the [✓] key to *recalibrate* buffer 1 and see step 9.
If "OVER" (OVER) or "Undr" (UNDER) (See chapter VIII. ERROR DISPLAYS AND TROUBLESHOOTING) is displayed or a blinking "SAVE" does not show after more than few minutes then something is wrong with your buffer 1 or electrode.

Be sure your buffer 1 is correct or change a new electrode and repeat from step 7.

11. Clean the pH electrode and temperature probe with the de-ionized/distilled water.
12. Place the pH electrode and Temperature probe into buffer 2.
13. Press the [OK] key to start the **SLOPE** calibration. A “**WAIT**” message will blink indicating that the instrument is waiting for a stable reading. The display will be locked to the buffer value corresponding to the temperature of buffer 2 (See chapter VIII. **pH Buffers**). When a stable reading is reached, the unit will blink a “**SAVE**” message at the MINOR LCD display.
14. Press the [OK] key to save the SLOPE calibration **OR** press the [▼] key to recalibrate buffer 2 and see step 13.

If “**OVER**” (OVER) or “**Undr**” (UNDER) (See chapter VII. **ERROR DISPLAYS AND TROUBLESHOOTING**) is displayed or a blinking “**SAVE**” does not show after more than few minutes then something is wrong with your buffer 2 or electrode. Be sure your buffer 2 is correct or change a new electrode and repeat from step.
15. Set-up your mA OUT and CONTROL RELAY settings.
16. The unit is ready for measurement and control.

vii. 4mA SETTING screen

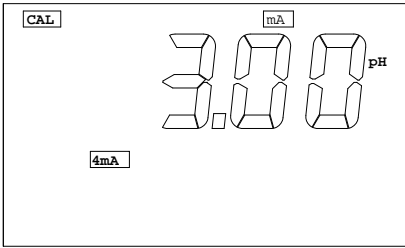

This screen will let the user change the 4 mA value. The user can use [\blacktriangle], [\blacktriangledown], [\blacktriangleright] or [**OK**] keys to input new 4mA value. This value is used for scaling the 4-20mA **ANALOG OUTPUT**. (For detailed explanation see chapter **VI. 4-20 mA OUTPUT**.)

viii. 20 mA SETTING screen

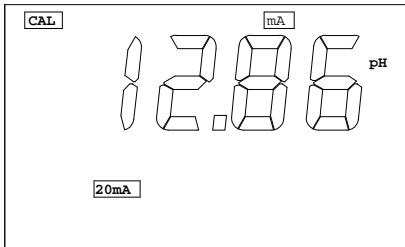

This screen will let the user change the 20 mA value. The user can use [\blacktriangle], [\blacktriangledown], [\blacktriangleright] or [**OK**] keys to input new 20mA value. This value is used for scaling the 4-20mA **ANALOG OUTPUT**. (For detailed explanation see chapter **VI. 4-20 mA OUTPUT**.)

ix. RELAY-1, RELAY-2 SETTING

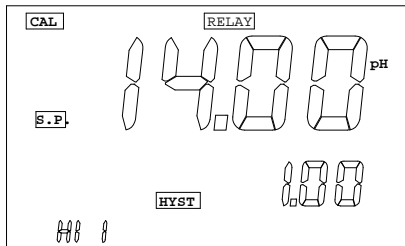

This screen is essentially the same for the two relays. Take note of the blinking character as there are 3 values to input for each relay. The user can use [\blacktriangle], [\blacktriangledown], [\blacktriangleright] or [**OK**] keys to input the **SET-POINT** then the **HYSTERISIS** and finally the **RELAY ACTION**. (See **V. CONTROLLING THE RELAYS**.)

x. PASSWORD SETTING

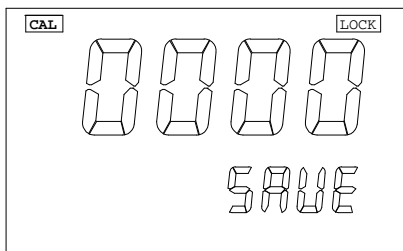

This screen selects the password number for this unit. The user can use [\blacktriangle], [\blacktriangledown] or [\blacktriangleright] keys to input the new password. Pressing the [OK] key will save the password number and LOCKS the unit. You will not be able to change any setting or turn-on

the wash relay unless a correct 4-digit number is selected in the **PASSWORD CHECK** screen.

CAUTION: *The user is responsible in remembering their password number otherwise you would not be able to calibrate or change the settings.*

2. ACTIVE "ABS mV"

If the user selected "pH", please see the previous section 1. ACTIVE "pH". If the user selected "REL", please see the next section 3. ACTIVE "REL").

i. TEMPERATURE PROBE SELECT screen

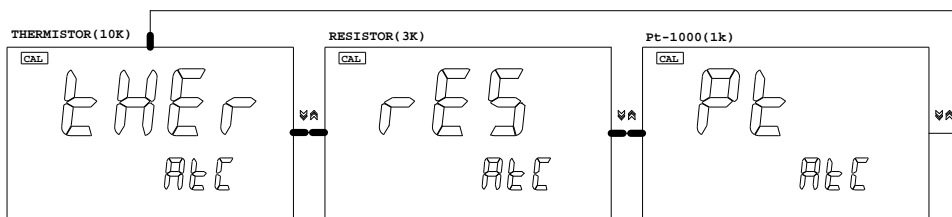

This screen will let the user select what temperature probe ($10K\Omega$ thermistor, Balco $3K\Omega$ resistor or RTD pt-1000) the user will use. This screen will always default to the last temperature probe the user selected. For most application the user will only use one kind of

temperature probe so the user don't need to change this selection once you select the correct temperature probe. If the user needs to change the temperature probe type, press the [\blacktriangle] or [\blacktriangledown] keys to choose your temperature probe then press [OK] to save your new selection.

ii. 4mA SETTING screen

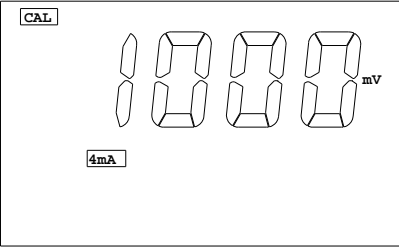

This screen will let the user change the 4 mA value. The user can use [\blacktriangle], [\blacktriangledown], [\blacktriangleright] or [OK] keys to input new 4mA value. This value is used for scaling the 4-20mA ANALOG OUTPUT. (For detailed explanation see chapter VI. 4-20 mA OUTPUT.)

iii. 20 mA SETTING screen

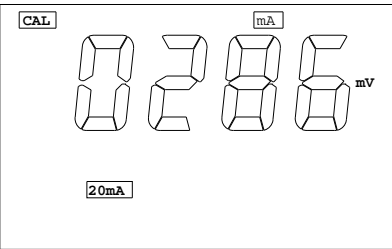

This screen will let the user change the 20 mA value. The user can use [\blacktriangle], [\blacktriangledown], [\blacktriangleright] or [OK] keys to input new 20mA value. This value is used for scaling the 4-20mA ANALOG OUTPUT. (For detailed explanation see chapter VI. 4-20 mA OUTPUT.)

iv. RELAY-1, RELAY-2 SETTING

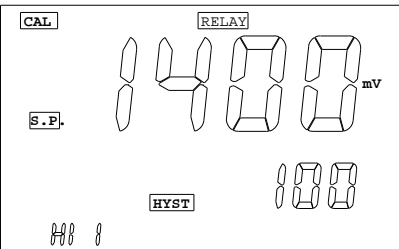

This screen is essentially the same for the two relays. Take note of the blinking character as there are 3 values to input for each relay. The user can use [\blacktriangle], [\blacktriangledown], [\blacktriangleright] or [OK] keys to input the SET-POINT first then the HYSTERISIS and finally

the RELAY ACTION. (See V. CONTROLLING THE RELAYS.)

v. PASSWORD SETTING

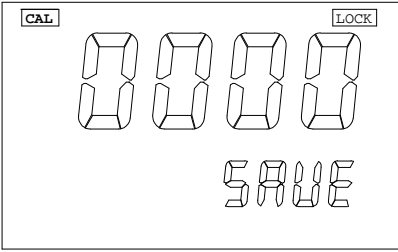

This screen selects the password number for this unit. The user can use [\blacktriangle], [\blacktriangledown] or [\blacktriangleright] keys to input the new password. Pressing the [OK] key will save the password number and LOCKS the unit. You will not be able change any setting or turn-on

the wash relay unless a correct 4-digit number is selected in the **PASSWORD CHECK** screen.

CAUTION: *The user is responsible in remembering their password number otherwise you would not be able to calibrate or change the settings.*

3. ACTIVE "REL"

If the user selected "pH", please the previous section **1. ACTIVE "pH"**. If the user selected "ABS", please see the previous section **2. ACTIVE "ABS"**.

i. TEMPERATURE PROBE SELECT screen

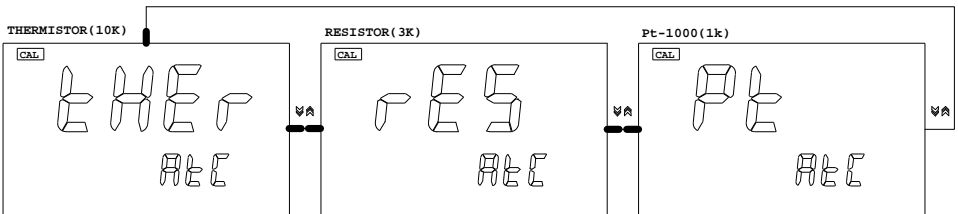

This screen will let the user select what temperature probe (10K Ω thermistor, Balco 3K Ω resistor or RTD pt-1000) the user will use. This screen will always default to the last temperature probe the user selected. For most application the user will only use one kind of

temperature probe so the user don't need to change this selection once you select the correct temperature probe. If the user needs to change the temperature probe type, press the [\blacktriangle] or [\blacktriangledown] keys to choose your temperature probe then press [OK] to save your new selection.

ii. OFFSET SETTING screen

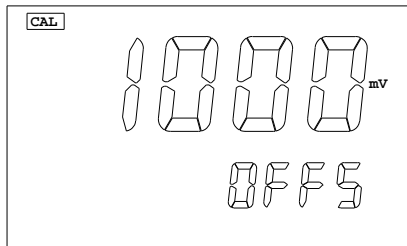

This screen selects the OFFSET for relative ORP. The value here will be subtracted from the absolute ORP reading to display the relative ORP reading. The equation is :
"REL mV" = "ABS mV" - "Offset"

iii. 4mA SETTING screen

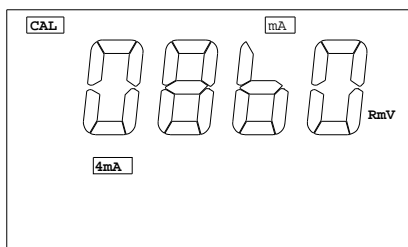

This screen will let the user change the 4 mA value. This value is used for scaling the 4-20mA ANALOG OUTPUT.
 (See chapter VI. 4-20 mA OUTPUT.)

iv. 20mA SETTING screen

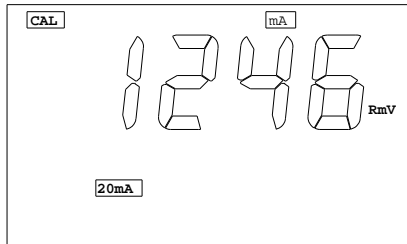

This screen will let the user change the 20 mA value. this value is used for scaling the 4-20mA ANALOG OUTPUT.
 (See chapter VI. 4-20 mA OUTPUT.)

v. RELAY-1, RELAY-2 SETTING screen

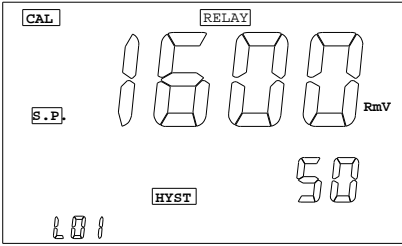

This screen is essentially the same for the two relays. Take note of the blinking character as there are 3 values to input for each relay. The user has to input the **SET-POINT** first then the **HYSTERISIS** and finally the **RELAY ACTION**.

(See chapter V. CONTROLLING THE RELAYS.)

vi. PASSWORD SETTING

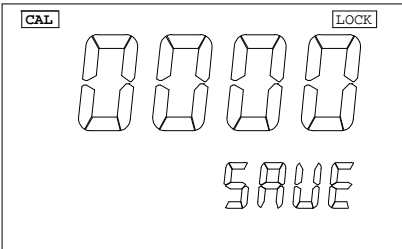

This screen selects the password number for this unit. The user can use [\blacktriangle], [\blacktriangledown] or [\blacktriangleright] keys to input the new password. Pressing the [OK] key will save the password number and LOCKS the unit. You will not be able change any setting or turn-on

the wash relay unless a correct 4-digit number is selected in the **PASSWORD CHECK** screen.

CAUTION: *The user is responsible in remembering their password number otherwise you would no be able to calibrate or change the settings.*

V. CONTROLLING THE RELAYS

A. ISOLATION VOLTAGE

The maximum isolation voltage of the relay output contacts is 1500 VDC. The voltage differential between the relay output contacts and the load should not exceed 1500 VDC.

B. OUTPUT LOAD

The current through the relay output contacts should not exceed 5 Amp at 115 VAC and 2.5 Amp at 230 VAC in order not to cause permanent damage to the relay contacts. This rating is specified for **resistive** loads only.

C. RELAY ACTION, RELAY SETPOINT & HYSTERESIS VALUE

Relay Action	Effective RELAY-ON Set Point	Effective RELAY-OFF Set Point
HIGH	S.P.	S.P. - (H.V)
LOW	S.P	S.P. +(H.V.)

S.P. = Relay Set point H.V.= Hysteresis value (Dead Band)

If the relay action is set to **HIGH**, the relay will turn **ON** at (SET POINT), and will turn **OFF** at (SET POINT-HYSTERISIS).

If the relay action is set to **LOW**, the relay will turn **ON** at (SET POINT), and will turn **OFF** at (SET POINT + HYSTERISIS).

There are two Independent relays the user can bind to pH, ABSOLUTE mV or RELATIVE mV mode. The user can *only* bind the two relays to one reading mode at a time. The user can change this anytime by changing option at the **CALIBRATION/ SETTING SELECT** screen.

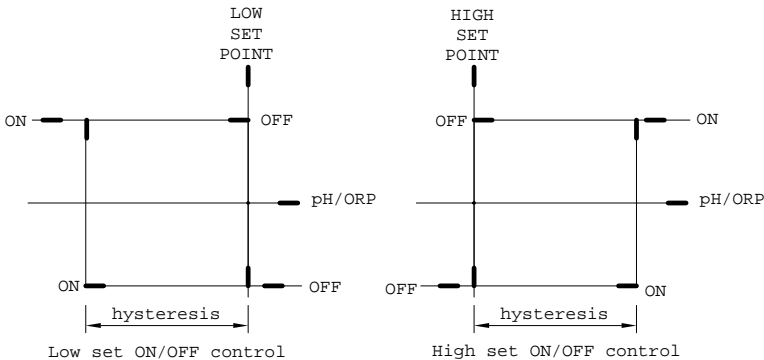

The figure above shows how the relays react to user set point, hysteresis and reading.

Note:

1. The ideal set point range for **pH** is 0.00 to 16.00 pH.
2. The ideal set point range for **ABS mV** is -2500 to 2500 mV.
3. The ideal set point range of for **REL mV** is -6499 to 6499 mV.

VI. 4 - 20 mA OUTPUT

A. ISOLATION VOLTAGE

The maximum isolation voltage of the 4-20 mA output is 500 VDC. The voltage differential between the 4-20 mA output and the load should not exceed 500 VDC.

B. OUTPUT LOAD

The maximum load is 500Ω. Output current inaccuracies may occur for load impedance in excess 500Ω.

C. LINEAR ANALOG OUPUT

The analog output will produce a linear analog output. The user can only bind the ANALOG OUTPUT to one reading at a time. The user can change this anytime by changing option at the **CALIBRATION/SETTING SELECT** screen.

The analog output will be restricted on the 4 mA setting, 20 mA setting and the current bound display.

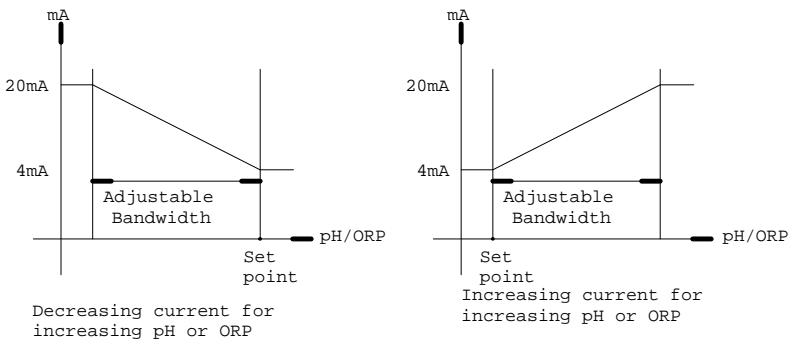

The above figure shows the relationship between Reading, U_{4mA} & U_{20mA} .

The analog output is based on the following equation:

$$mA_{(output)} = 4mA + (16mA) * (D - U_{4mA}) / (U_{20mA} - U_{4mA})$$

Where:

$mA_{(output)}$ = analog output

D = current bound display

U_{4mA} = user setting for 4 mA for current bound display

U_{20mA} = user setting for 20 mA for current bound display

Note:

1. The ideal range of U_{4mA} and U_{20mA} for **pH** is 0.00 to 16.00 pH.
2. The ideal range of U_{4mA} and U_{20mA} for **ABS mV** is -2500 to 2500 mV.
3. The ideal range of U_{4mA} and U_{20mA} for **REL mV** is -6499 to 6499 mV.
4. The absolute difference of U_{4mA} and U_{20mA} for **pH, ABS mV & REL mV** must be greater or equal to **0.20 pH, 20 mV, 20 RmV** respectively.

VII. ERROR DISPLAYS AND TROUBLESHOOTING

MAJOR LCD display	MINOR LCD display	DISPLAY unit	Possible cause(s) [Action(s)]
"OVER"	"OVER"	pH	a. Temperature > 120.0°C. [Bring buffer/solution to a lower temperature.] [Replace temperature probe.] b. No temperature sensor. [Use a temperature probe.]
"OVER"	"Undr"	pH	Temperature < -10.0°C. [Bring buffer/solution to a higher temperature.]

"OVER"	-10.0~ 120.0°C	pH	pH>16.00 . [Recalibrate.]
"OVER"	0.0 ~ 60.0°C	pH-Cal	pH>16.00. [Use a new buffer solution.] [Replace the electrode.]
"OVER"	0.0 ~ 60.0°C	a.pH-Cal-STAND buffer 7.00pH b.pH-Cal-STAND buffer 6.86 pH c. pH-Cal-SLOPE	a. Offset>100mV b. Offset>108.3mV c. Slope>ideal mV by 30% [Use a new buffer solution.] [Replace electrode.]
"Undr"	-10.0~ 120.0°C	pH	pH<-2.00 [Recalibrate.]
"Undr"	0.0 ~ 60.0°C	a.pH-Cal-STAND buffer 7.00pH b.pH-Cal-STAND buffer 6.86 pH c.pH-Cal-SLOPE	a. Offset <-100mV b.Offset < -91.7 mV c. Slope<ideal slope by 30% [Use a new buffer solution.] [Replace electrode.]
"OVER"	don't care	ORP (ABS or REL)	a. ORP ABS display > +2500 mV [Bring solution to a lower ORP reading]
"Undr"	don't care	ORP (ABS or REL)	a. ORP ABS display < -2500 mV [Bring solution to a higher ORP reading]
don't care	"OVER"		a. Temperature > 120.0°C. [Bring solution to a lower temperature.] [Replace temperature probe.] b. No temperature sensor. [Use a temperature probe.]
don't care	"Undr"		Temperature < -10.0°C. [Bring buffer/solution to a higher temperature.]
"EEP"	"bAd"	During power-on	Unit has failed its EEPROM test. [Turn instrument OFF and back to ON again.] [Return for service. (see Warranty)]

"rO-"	"bAd"	During power-on	Unit has failed its ROM test. [Turn instrument OFF and back to ON again.] [Return for service. (see Warranty)]
"rA-"	"bAd"	During power-on	Unit has failed its RAM test. [Turn instrument OFF and back to ON again.] [Return for service. (see Warranty)]

VIII. pH BUFFERS

The temperature characteristics of pH calibration buffers pH1.68, pH4.00, pH4.01, pH6.86, pH7.00, pH9.18 , pH10.01 & pH12.46 are stored inside the instrument. The buffers used to calibrate the instrument must exhibit the same temperature characteristics as the stored values.

TABLE 1.

°C	1.68	4.00	6.86	9.18	4.01	7.00	10.01	12.46
0	1.67	4.01	6.98	9.46	4.01	7.11	10.32	13.42
5	1.67	4.00	6.95	9.39	4.01	7.08	10.25	13.21
10	1.67	4.00	6.92	9.33	4.00	7.06	10.18	13.01
15	1.67	4.00	6.90	9.28	4.00	7.03	10.12	12.80
20	1.68	4.00	6.88	9.23	4.00	7.01	10.06	12.64
25	1.68	4.00	6.86	9.18	4.01	7.00	10.01	12.46
30	1.68	4.01	6.85	9.14	4.01	6.98	9.97	12.30
35	1.69	4.02	6.84	9.10	4.02	6.98	9.93	12.13
40	1.69	4.03	6.84	9.07	4.03	6.97	9.89	11.99
45	1.70	4.04	6.83	9.04	4.04	6.97	9.86	11.84
50	1.71	4.06	6.83	9.02	4.06	6.97	9.83	11.71
55	1.72	4.07	6.83	8.99	4.08	6.97	9.80	11.57
60	1.72	4.09	6.84	8.97	4.10	6.98	9.78	11.45

Note: The actual reading of the instrument can differ from the values shown by ± 0.01 pH.

IX. SPECIFICATIONS

Mode	Range	Resolution	Accuracy
pH	-2.00 to 16.00 pH	0.01 pH	±0.1% of rdg ± 1 LSD
ORP Absolute mV	-2500 to 2500 mV	1 mV	±0.1% of rdg ± 1 LSD
ORP Relative mV	-6499 to 6499 mV	1 mV	±0.1% of rdg ± 1 LSD
Temperature	-10.0 to 120.0 °C	0.1 °C	±0.1 °C ± 1 LSD

pH

Recognized pH buffers

pH4.00, pH6.86, pH7.00 & pH1.68,

pH4.01, pH9.18, pH10.01, pH12.46

pH Temperature compensation

Auto -10.0°C to 120.0 °C

pH Buffer Temperature range

0.0°C to 60.0 °C

pH Electrode Offset recognition

±100 mV at pH 7.00

+108.3 mV/-91.7 mV at pH 6.86

pH Electrode Slope recognition

±30% at pH 1.68, 4.00, 4.01, 9.18, 10.01 & 12.46

Input impedance

>10¹²Ω

Calibration end point sensing

Yes

Temperature

Temperature sensor

(User selectable)

Thermistor :10.00kΩ at 25 °C,

Resistor : Balco 3KΩ at 25 °C

RTD : pt-1000, α =0.00385

4-20 mA Output

Current output range

4 to 20 mA (isolated)

Current output scale

user programmable

Maximum load

500 Ω

Accuracy

± 0.02mA

Isolation voltage

500VDC

Controller

Control type

(two) ON/OFF control

Relay output (Resistive load only)

5A at 115VAC or 2.5A at 220VAC

GENERAL

Keys	Audio feedback in all keys
Security protect	4-digit password
Power:	115VAC or 230VAC 50/60Hz
Ambient Temperature range	0.0 to 50.0°C
Display(pH/ORP :Temp.)	16mm : 8.5mm high LCD
Case	IP65, ¼ DIN case, depth 148mm
Weight	940g

X. WARRANTY

Jenco Instruments, Ltd. warrants this product to be free from significant deviations in material and workmanship for a period of 1 year from date of purchase. If repair or adjustment is necessary and has not been the result of abuse or misuse, within the year period, please return-freight-prepaid and the correction of the defect will be made free of charge. If you purchased the item from our Jenco distributors and it is under warranty, please contact them to notify us of the situation. Jenco Service Department alone will determine if the product problem is due to deviations or customer misuse. Out-of-warranty products will be repaired on a charge basis.

RETURN OF ITEMS

Authorization must be obtained from one of our representatives before returning items for any reason. When applying for authorization, have the model and serial number handy, including data regarding the reason for return. For your protection, items must be carefully packed to prevent damage in shipment and insured against possible damage or loss. Jenco will not be responsible for damage resulting from careless or insufficient packing. A fee will be charged on all authorized returns.

NOTE: Jenco reserves the right to make improvements in design, construction and appearance of our products without notice.

XI. KEYBOARD FLOWCHARTS

A. pH MODE

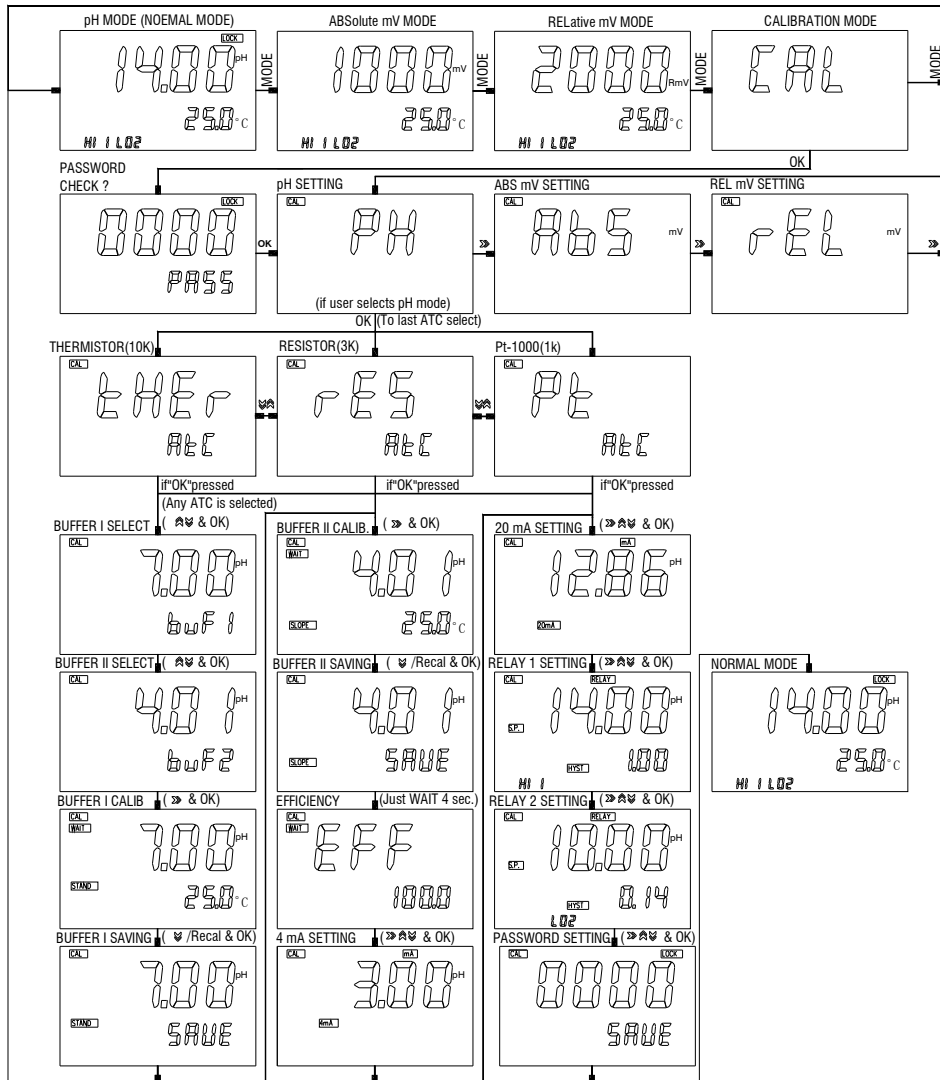

B. ABSOLUTE mV

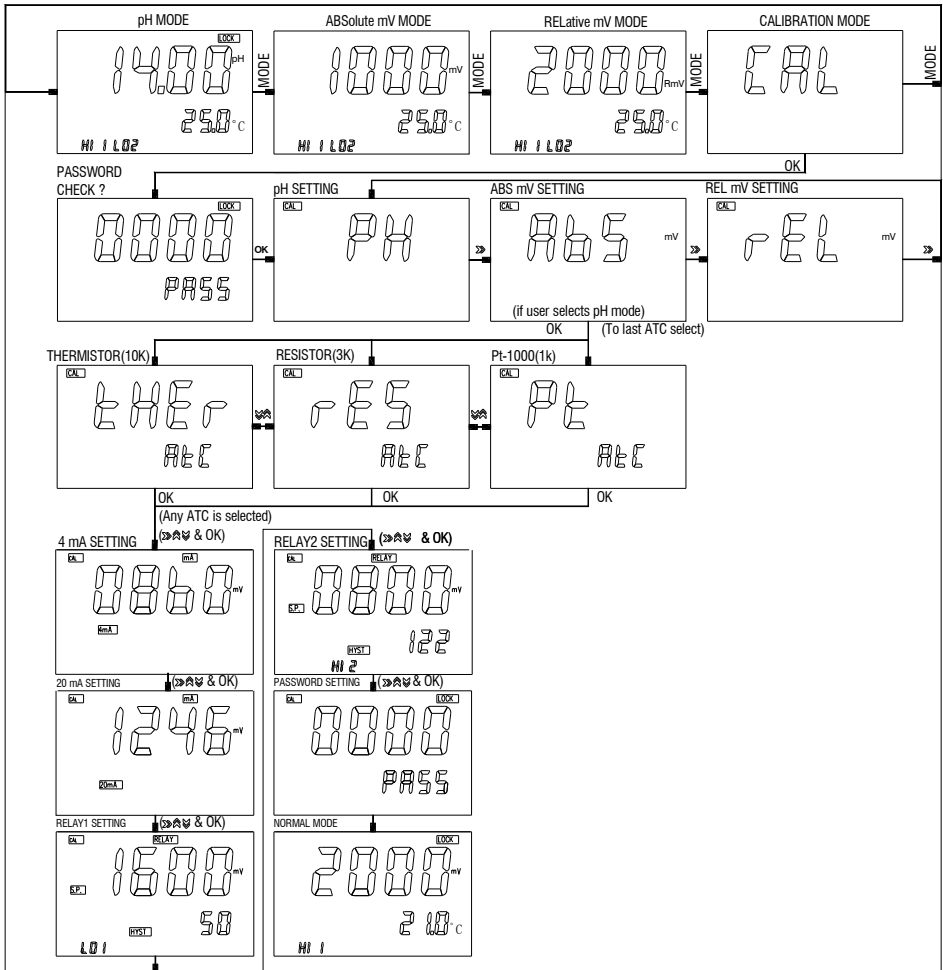

C. RELATIVE mV

