

# Operation Manual

---

---

## MODEL 3331

Microcomputer Based Conductivity/Resistivity Transmitter

**JENCO** ELECTRONICS, LTD.

MANUFACTURER OF PRECISION INSTRUMENTS

# CONTENTS

<b>GENERAL INTRODUCTION</b> .....	<b>2</b>
<b>INITIAL INSPECTION</b> .....	<b>2</b>
<b>USING THE JENCO MODEL 3331</b> .....	<b>3</b>
<b>A. Mounting procedure</b> .....	<b>3</b>
<b>B. Front panel</b> .....	<b>5</b>
<b>C. LCD screen</b> .....	<b>7</b>
<b>D. Rear connectors</b> .....	<b>8</b>
<b>E. Measure mode</b> .....	<b>10</b>
<b>F. Setting mode</b> .....	<b>11</b>
<b>G. Conductivity/Resistivity calibration mode</b> .....	<b>18</b>
<b>H. 4 ~ 20 mA output</b> .....	<b>18</b>
<b>ERROR DISPLAY AND TROUBLESHOOTING</b> .....	<b>21</b>
<b>SPECIFICATIONS</b> .....	<b>23</b>
<b>WARRANTY</b> .....	<b>25</b>

## GENERAL INTRODUCTION

Thank you for selecting the JENCO Model 3331. The 3331 Conductivity/Resistivity transmitter is a rugged microprocessor based instrument assembled in a watertight 1/8 DIN case, designed for use in laboratories and process control applications.

The system displays Conductivity / Resistivity or Temperature status in one large LCD screen.

The model 3331 microprocessor performs a self-diagnostic routine every time you turn on the unit, it will provide you with basic information on the stability of the instrument.

The model 3331 has an isolated 4-20 mA analog output, offset and span configurable for the Conductivity or Resistivity display.

## INITIAL INSPECTION

Carefully unpack the unit and accessories. Inspect for damages made in shipment. If any damage is found, notify your **Jenco** representative immediately. All packing materials should be saved until satisfactory operation is confirmed.

## USING THE JENCO MODEL 3331

### A. Mounting Procedure

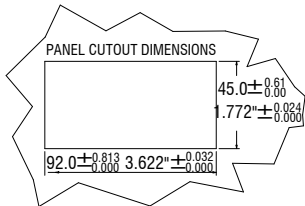

**DRAWING 1**

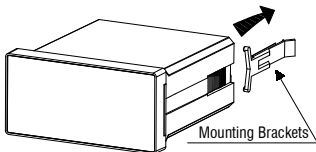

**DRAWING 2**

1. Make a cutout on any panel, with a thickness of 1/16 inch (1.5mm) to 3/8 inch (9.5mm). Refer to **DRAWING 1**.
2. Remove the mounting assembly from the controller and insert the controller into the cutout. Refer to **DRAWING 2**.

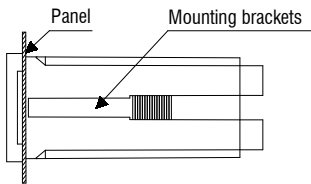

**DRAWING 3**

3. Replace the mounting bracket assembly onto the controller and secure the controller to the mounting panel. Refer to **DRAWING 3**.

***【Note】*** :

If the equipment is used in a manner not specified by the manufacturer, the protection provided by the equipment may be impaired.

## B. Front Panel

The front panel consists of a 4-digit LCD display and 4 keys.

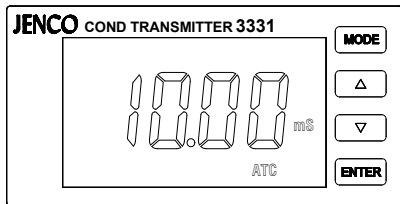

1. [ **MODE** ] key:

1a. In the **Measure mode**, this key will switch the display in sequence from Conductivity, Temperature and back to Conductivity again or from Resistivity, Temperature and back to Resistivity again.

1b. In the **Calibration/Setting mode**, pressing this key for five seconds will move you back to the previous parameter in the case when recalibration / resetting is required.

2. **[ UP ]** key:
  - 2a. In the **Calibration mode**, pressing this key will increase the numeral increment. In the **Setting mode**, pressing this key will show the next possible option and increase the numeral increment.
  - 2b. In the **Measure mode**, pressing this key and **[ENTER]** key at the same time, the unit will enter the **Calibration mode**.
3. **[ DOWN ]** key:
  - 3a. In the **Calibration mode**, pressing this key will decrease the numeral increment. In the **Setting mode**, pressing this key will show the next possible option and decrease the numeral increment.
  - 3b. In the **Measure mode**, pressing this key and **[ENTER]** key at the same time, the unit will enter the **Setting mode**.
4. **[ ENTER ]** key:

In any mode where the user can change the settings, pressing this key will save the new settings. If no change has been made then pressing this key will just lead

the user to the next setting.

### C. LCD screen

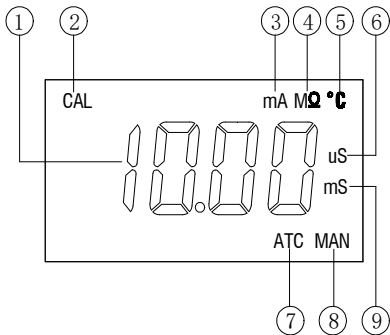

1. Major LCD display.
2. **CAL** – This icon will be displayed if the meter is in the **Calibration/Setting mode**.
3. **mA** – This icon, when displayed, indicates the meter is in the **4 mA** or **20 mA Setting mode**.



4.  $M\Omega$ – Unit indicator.
5.  $^{\circ}C$  – Temperature and unit display.
6.  $\mu S$  – Unit indicator.
7. **ATC** –This icon will be displayed when a temperature probe is connected.
8. **MAN** –This icon will be displayed if no temperature probe is not connected.
9. **mS** – Unit indicator.

**D. Rear connectors**

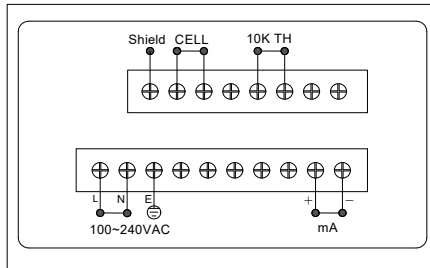

\* Specify "L" = "Live Lead" 100 to 240 VAC Volts and "N" = "Neutral Lead"

1. Connect the AC line to the rear of the instrument. The model 3331 can be used with 100 to 240 V AC at 50/60 HZ. Make sure the **EARTH** connector is connected to the earth lead of the AC power line.
2. Set the proper load to the 4-20 mA-output connector. Make sure that the load impedance is less than 500 Ohms.

***【Note】*** :

- (1) Make sure that the power is unplugged before wiring your probes etc.
- (2) Make sure you connect the AC power cord to the correct AC terminals. Incorrect connection may damage the unit permanently.

## E. Measure mode

Turning on the unit will always display the **Measure mode**. This instrument is designed to provide 2 distinct measurements: Conductivity, Temperature or Resistivity, Temperature.

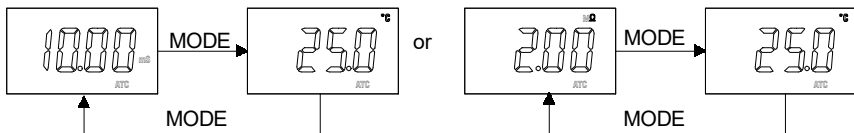

1. **Conductivity** – Current conductivity of the solution.
2. **Resistivity** – Current resistivity of the solution.
3. **Temperature** – Current temperature of the solution.

### ***[Note] :***

Pressing [**MODE**] key in the **Measure mode** will cycle the display between the two modes above.

## F. Setting mode

Pressing [**DOWN**] key and [**ENTER**] key at the same time, the meter will enter into the **Setting mode**.

### 1. **Temperature compensation select:**

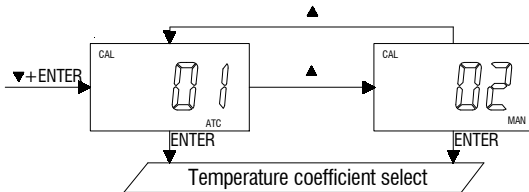

Pressing [**UP**] key or [**DOWN**] key in this screen will cycle the display between 01 (Thermistor: 10k ohm), 02 (Manual) modes above.

Select the preferred temperature compensation mode, press [**ENTER**] key to save, and enter the next setting screen.

## 2. Temperature Coefficient select:

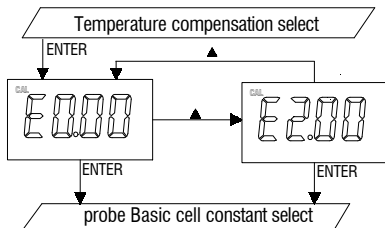

Pressing **[UP]** key or **[DOWN]** key in this screen will cycle the display between E2.00, E0.00 above.

Select the preferred coefficient, press **[ENTER]** key to save, and enter the next setting screen.

### 3. Probe Basic cell constant select:

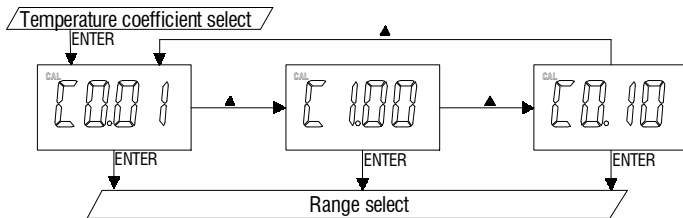

Pressing **[UP]** key or **[DOWN]** key in this screen will cycle the display from C1.00, C0.10 to C0.01 basic cell constant above.

Select the preferred basic cell constant, press **[ENTER]** key to save, and enter the next setting screen.

#### 4. Range select:

Pressing [UP] key or [DOWN] key in this screen will cycle the display from CF01/0.000~1.999uS/cm, CF02/0.00~19.99uS/cm, CF03/0.000~1.999M $\Omega$ , CF04/0.00~19.99M $\Omega$ (**Basic cell K is C0.01**) or CF01/0.00~19.99uS/cm, CF02/0.0~199.9uS/cm(**Basic cell K is C0.10**) or CF01/0.0~199.9uS/cm, CF02/0~1999uS/cm, CF03/0.00~19.99mS/cm (**Basic cell K is C1.00**) above.

Select the preferred basic cell constant , press [ENTER] key to save, and enter the next setting screen.

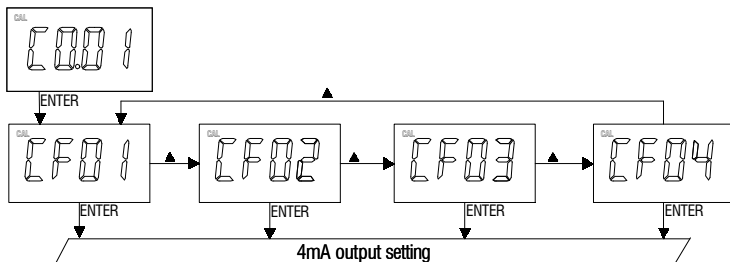

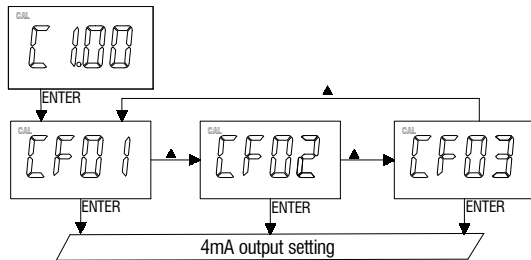
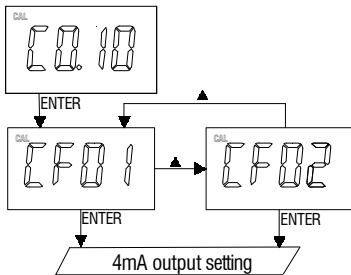



## 5. 4 mA output setting:

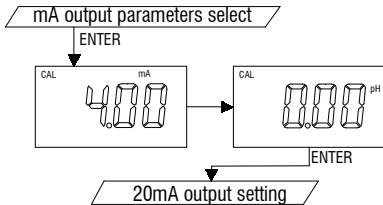

Pressing **[UP]** key or **[DOWN]** key in this screen to adjust the 4 mA value, this value is used for scaling the 4-20 mA analog output.

Pressing **[ENTER]** key to save, and enter the next setting screen.

6. **20 mA output setting:**

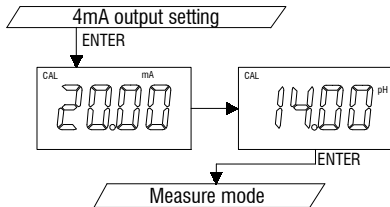

Pressing **[UP]** key or **[DOWN]** key in this screen to adjust the 20 mA value, this value is used for scaling the 4-20 mA analog output.

Pressing **[ENTER]** key to save, and goes to the **Measure mode**.

## **G. Conductivity/Resistivity Calibration mode**

The model 3331 uses 1-point calibration for conductivity or resistivity.

In the **Measure mode**, pressing **[UP]** key and **[ENTER]** key at the same time to allow the meter to go to the **Conductivity / Resistivity calibration mode**.

At the **Conductivity / Resistivity calibration mode**, the “**CAL**” icon and a conductivity/resistivity reading will display. Rinse the conductivity probe in distilled water and immerse it into the standardization solution. Allow temperature reading to stabilize, press **[UP]** key or **[DOWN]** key to change this reading to that of the standardization solution value, then press **[ENTER]** key to save. Calibration is now completed.

## **H. 4-20 mA output**

### **1. Isolation voltage:**

The maximum isolation voltage of the 4-20 mA output contacts is 500 VDC. The voltage differential between the 4-20 mA output contacts and the load should not exceed 500 VDC.

2. **Output load:**

The maximum load is 500 ohm. Output current inaccuracies may occur for load impedance in excess 500 ohm.

3. The analog output will produce a linear analog output. The user can only bind the **ANALOG OUTPUT** to one reading at a time. The user can change this anytime by changing option at the **Calibration/Setting mode** screen.

The analog output will be restricted on the 4 mA setting, 20 mA setting and the current bound display.

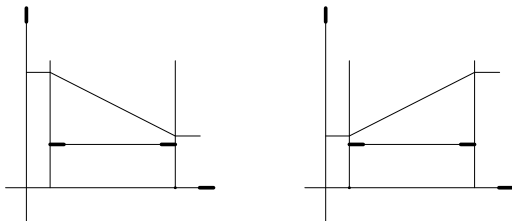

The above figure shows the relationship between Reading,  $U_{4mA}$  &  $U_{20mA}$ .

The analog output is based on the following equation:

$$mA(\text{output}) = 4 \text{ mA} + (16 \text{ mA}) * (D - U_{4mA}) / (U_{20mA} - U_{4mA})$$

Where:

$mA(\text{output})$  = analog output

$D$  = current bound display

$U_{4mA}$  = user setting for 4 mA for current bound display

$U_{20mA}$  = user setting for 20 mA for current bound display

## ERROR DISPLAY AND TROUBLESHOOTING

Conductivity /Resistivity Display	Temperature Display	Display Mode	Possible cause(s) [Action(s)]
"OvEr"	-10.0 to 120.0 °C	Measure mode	Reading is over the specified range. [Change range to higher level]
"Undr"	-10.0 to 120.0 °C	Measure mode	Reading is under user specified range. [Change range to lower level] [Immerse the conductivity probe into standization solution.]
"OvEr"	"OvEr"	Measure mode	a. Temperature > 120.0 °C. [Bring standization solution to

			<p>lower temperature.]</p> <p>[Replace temperature probe.]</p> <p>b. No temperature sensor.</p> <p>[Adjust the manual temperature to -10 to 120 °C.]</p>
"OvEr"	"Undr"	Measure mode	<p>a. Temperature &lt; -10.0 °C.</p> <p>[Bring standization solution to higher temperature.]</p> <p>[Replace temperature probe.]</p> <p>b. No temperature sensor.</p> <p>[Adjust the manual temperature to -10 to 120 °C.]</p>

## SPECIFICATIONS

### Conductivity/Resistivity:

Basic Cell K	Range	Resolution	Accuracy
0.01	0.000 to 1.999 uS/cm 0.00 to 19.99 MΩ	0.001 uS/cm 0.01 MΩ	±0.5%F.S. ± 1 digit
0.01	0.00 to 19.99 uS/cm 0.000 to 1.999 MΩ	0.01 uS/cm 0.001 MΩ	±0.5%F.S. ± 1 digit
0.10	0.00 to 19.99 uS/cm	0.01 uS/cm	±0.5%F.S. ± 1 digit
0.10	0.0 to 199.9 uS/cm	0.1 uS/cm	±0.5%F.S. ± 1 digit
1.00	0.0 to 199.9 uS/cm	0.1 uS/cm	±0.5%F.S. ± 1 digit
1.00	0 to 1999 uS/cm	1 uS/cm	±0.5%F.S. ± 1 digit
1.00	0.00 to 19.99 mS/cm	0.01 mS/cm	±0.5%F.S. ± 1 digit
Temperature	-10.0 to 120.0 °C	0.1 °C	±0.3 °C



**Conductivity/Resistivity:**

Cell Constant	0.01, 0.1, 1.0; 2 wire.
Reference Temperature	25.0 °C, factory set.
Temperature Coefficient	2.00 or 0.00%, user selectable.

**Temperature:**

Temperature sensor (User selectable)	Thermistor: 10 k $\Omega$ at 25 °C, Manual
---	---

**4-20 mA output:**

Current output range	4 to 20 mA (isolated)
Current output scale	user programmable
Maximum load	500 $\Omega$
Accuracy	$\pm 0.03$ mA
Isolation voltage	500 VDC

**General:**

Keys	Audio feedback in all keys
------	----------------------------

Power:	100 to 240 VAC $\pm$ 10% , 50/60 Hz
Ambient Temperature range	0.0 to 50.0 °C
Case	IP65, 1/8DIN case, depth 90 mm
Weight	290 g

## WARRANTY

**Jenco** warrants this product to be free from significant deviations in material and workmanship for a period of 1 year from date of purchase. If repair or adjustment is necessary and has not been the result of abuse or misuse, within the year period, please return-freight-prepaid and the correction of the defect will be made free of charge. If you purchased the item from our **Jenco** distributors and it is under warranty, please contact them to notify us of the situation. **Jenco** Service Department alone will determine if the product problem is due to deviations or customer misuse.

Out-of-warranty products will be repaired on a charge basis.

### RETURN OF ITEMS

Authorization must be obtained from one of our representatives before returning

items for any reason. When applying for authorization, have the model and serial number handy, including data regarding the reason for return. For your protection, items must be carefully packed to prevent damage in shipment and insured against possible damage or loss. **Jenco** will not be responsible for damage resulting from careless or insufficient packing. A fee will be charged on all authorized returns.

**【Note】** : **Jenco** reserves the right to make improvements in design, construction and appearance of our products without notice.

**Jenco Instruments, Inc.**

7968 Arjons Drive, Suite C  
San Diego, CA 92126 USA

TEL: 858-578-2828 FAX: 858-578-2886

E-Mail: [jencoinfo@jencoi.com](mailto:jencoinfo@jencoi.com); [sales@jencoi.com](mailto:sales@jencoi.com)

Website: [www.jencoi.com](http://www.jencoi.com)

**Jenco Electronics, Ltd.**

6F., No. 81, Sec. 2, Chang-an E. Rd., Jhongshan District, Taipei City 104, Taiwan

TEL: 886-2- 2508-2928 FAX: 886-2- 2508-2938

E-Mail: sales@JENCO.com.tw

Website: www.jenco.com.tw

**Shanghai Jenco Instruments, Ltd.**

18 Wang Dong Zhong Road

Sijing Town, Songjiang

Shanghai, China

TEL: 86-021-5761-9599 FAX: 86-021-5761-9598

E-Mail: sales@jenco.com.cn

Website: www.jenco.com.cn