

Martini 50

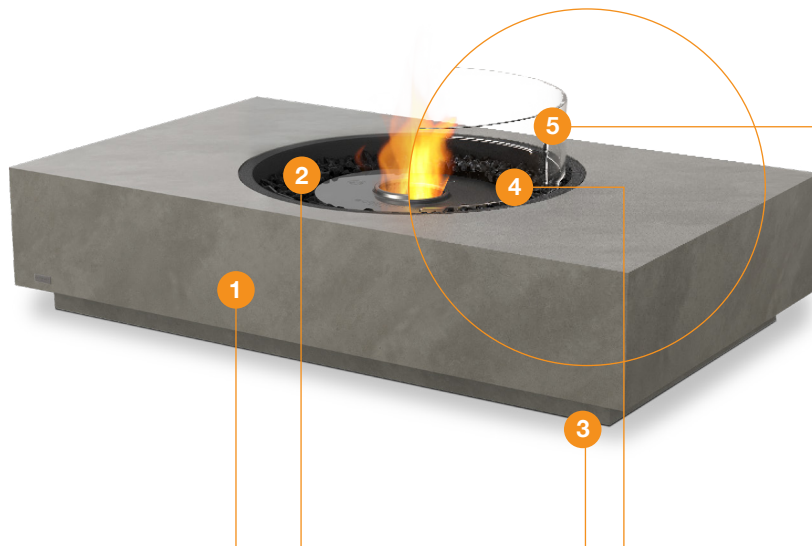

Martini 50 Design features



1. Fluid™ Concrete Finish

Incredibly strong yet relatively lightweight, EcoSmart's concrete products incorporate revolutionary Fluid Concrete Technology. Fluid features a stain and impact-resistant barrier that protects the concrete from environmental weathering – even under extreme conditions and long UV exposure.

Premium Teak Wood Finish

Classed as the most premium wood on the planet, teak is the strongest, most durable hardwood available. Teak contains a natural oil which repels water, keeping it from warping, cracking, or becoming brittle. Teak is the perfect material for outdoor furniture.

Surround Colours/Finishes

Our Fires are available in three Fluid Concrete colours or Natural Teak hardwood.



Natural



Graphite



Bone



Teak

2. Decorative Media

Concrete models come with black glass charcoal.

3. Articulating Feet

Our Fire Pits and Tables feature 360° height-adjustable articulating feet, so you can achieve a perfectly level and stable model before operating the fireplace.

Environmentally-Friendly

Bioethanol fireplaces use an environmentally-friendly, renewable energy source that burns clean and delivers warming heat. You and your guests will enjoy the ambiance and tranquility of a real fire, without the hassles of burning real wood - no more embers, ash, and soot to clean up.

4. Burner Colours

Available with a Stainless Steel or Black Burner.

5. Optional Fire Screen

Pair with a toughened glass fire screen, which stabilises the flame in windy conditions.

Quick & Easy Installation

With no installation or building works required, simply unpack, put into position, and off you go.

Global Compliance

This model complies with existing standards in the USA, Europe, UK and Australia. O-TL listed to UL 1370, EN 16647 BSI Certified and ACCC Safety Mandate compliant.

Included Accessories



Jerry Can with Safety Spout & e-NRG bottle adaptor



Lighting Rod & Lighter



AB8 Efficiency Ring



Black Glass Charcoal

Optional Accessories

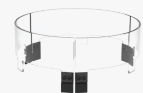

Glass Fire Screen

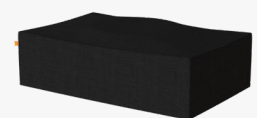

Outdoor Cover

Disclaimer: All product specifications and data are subject to change without notice and believed to be correct at the time of publication. MAD Design Group (MDG), its affiliates, agents, and employees, and all persons acting on its or their behalf (collectively, "MAD Design Group"), disclaim any and all liability for any errors, inaccuracies or incompleteness contained herein or in any other disclosure relating to any product. MDG disclaims any and all liability arising out of the use or application of any product described herein or of any information provided herein to the maximum extent permitted by law. The product specifications do not expand or otherwise modify MDG's terms and conditions of purchase, including but not limited to the warranty expressed therein, which apply to these products. No license, express or implied, by estoppel or otherwise, to any intellectual property rights is granted by this document or by any conduct of MDG. Customers using or selling MDG products not expressly indicated for use in such applications do so entirely at their own risk and agree to fully indemnify MDG for any damages arising or resulting from such use or sale. Please contact authorised personnel from MDG to obtain written terms and conditions regarding products designed for such applications. Images are indicative only.







Martini 50 Specifications

Featuring a sunken circular flame at its centre and sufficient space to set down food or drinks, Martini 50 becomes a welcoming destination.

Burner Ventilation and Efficiency*

Dimensions L x W x H mm/in	Compatible Burner	Fuel Capacity	Heats on Average (Indoors)	Thermal Output Net (MAX per burner)	Approx. Burn Time	Minimum Room Size
1270 x 762 x 296 50 x 30 x 11.7	AB8	8 L [2.1 Gals]	Over 60 m ² [645 ft ²]	21.56 MJ/h 20,433 BTU/h, 5.99 kW	7 - 9 hours	116 m ³ [4,096 ft ³]
			Over 30 m ² [322.9 ft ²]	13.9 MJ/h 12,860 BTU/h, 3.77 kW	9 - 11 hours	

With AB8 Efficiency Ring (EN Compliant)**

Application ¹	Indoor & Outdoor	
Surround Colours	 Natural ESF.O.MTI.50.NA	 Graphite ESF.O.MTI.50.GH
	 Bone ESF.O.MTI.50.BO	 Teak ESF.O.MTI.50.NF
Burner Colours	 Stainless Steel	 Black
Materials	Fluid Concrete or Teak Wood Surround, Grade 304 Stainless Steel Burner, with optional Black Ceramic Coating	
Approx. Weight	Concrete 48.4kg [106.6lbs] Teak 42.4kg [93.4lbs] Weight includes burner and black glass charcoal.	
Fuel Type	e-NRG Bioethanol / e-NRG.com	

Line drawings show concrete models with the optional Glass Fire Screen accessory.

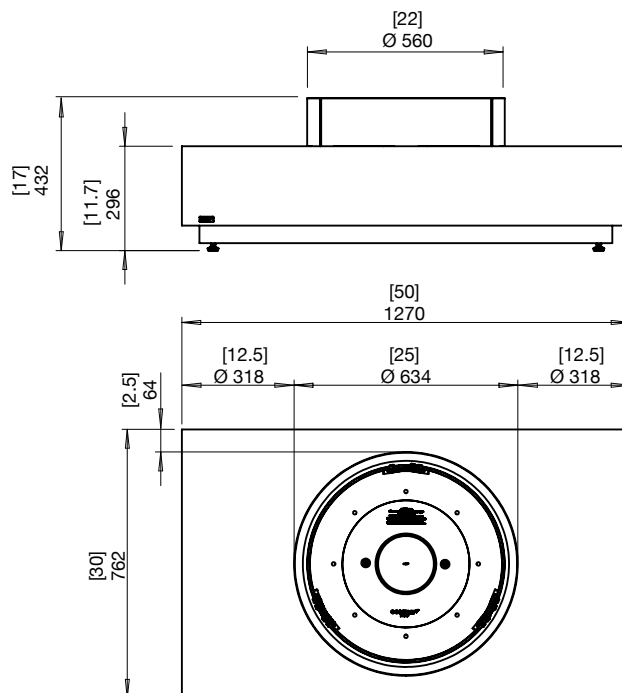

*These values are indicative only and may vary depending on the model purchased, installation, and the seasonal resource used to manufacture e-NRG.

This model comes with fixing brackets for permanently locating into a fixed position.

¹For Indoor Use, additional parts are required. Your chosen application is the ONLY application the model can be used in due to modified configuration of the model. Please advise your Sales Representative at time of purchase so that the product can be configured accordingly.

This model complies with existing standards in the USA, Europe, UK and Australia. O-TL listed to UL 1370, EN 16647 BSI Certified and ACCC Safety Mandate compliant. **To comply with EN 16647 the Indoor Safety Tray and included AB8 Burner Efficiency Ring must be installed before operating indoors.

FOR MORE INFORMATION PLEASE REFERENCE THE CLEARANCE & INSTALLATION MANUAL

Disclaimer: All product specifications and data are subject to change without notice and believed to be correct at the time of publication. MAD Design Group (MDG), its affiliates, agents, and employees, and all persons acting on its or their behalf (collectively, "MAD Design Group"), disclaim any and all liability for any errors, inaccuracies or incompleteness contained herein or in any other disclosure relating to any product. MDG disclaims any and all liability arising out of the use or application of any product described herein or of any information provided herein to the maximum extent permitted by law. The product specifications do not expand or otherwise modify MDG's terms and conditions of purchase, including but not limited to the warranty expressed therein, which apply to these products. No license, express or implied, by estoppel or otherwise, to any intellectual property rights is granted by this document or by any conduct of MDG. Customers using or selling MDG products not expressly indicated for use in such applications do so entirely at their own risk and agree to fully indemnify MDG for any damages arising or resulting from such use or sale. Please contact authorised personnel from MDG to obtain written terms and conditions regarding products designed for such applications. Images are indicative only.