

# USER MANUAL

## Woodland Play Centre

---



**WARNING:** The disassembled product may contain small parts which pose a choking hazard to children under 3.

### **IMPORTANT:**

The owner's manual contains safety, assembly, use and maintenance instructions. This product must be assembled by an adult who has read and understood these instructions. Keep the packaging away from children and dispose of all packaging before use.

*For the installer and your children's safety, it is important to fully read and understand the instructions and safety hazards before commencing the assembly of the product.*

### **NOTE:**

This manual should not be used to guide your purchasing decision. Your product, and the contents inside its carton, may vary from what is listed in this manual. This manual may also be subject to updates or changes. Updated manuals are available through our website at [www.forestandfrolic.co.nz](http://www.forestandfrolic.co.nz).

---

# TABLE OF CONTENTS

<b>I. GENERAL SAFETY INSTRUCTIONS</b>	3
1.1 Danger for Children	3
1.2 Risk of Injuries	3
1.3 Risk of Injuries	3
1.4 Assembly Advice	4
<b>II. SAFETY INSTRUCTIONS</b>	5
<b>III. ASSEMBLY INSTRUCTIONS</b>	7
<b>IV. MAINTENANCE</b>	30
<b>V. FREQUENTLY ASKED QUESTIONS</b>	31
<b>VI. WOOD ADVICE</b>	33
<b>VII. CLEANING</b>	34
<b>VIII. WARRANTY</b>	35

---

# I. GENERAL SAFETY INSTRUCTIONS

**NOTE:** This product is intended for outdoor domestic use only.

## 1.1 DANGER FOR CHILDREN



**WARNING:** No eating while using the product at the same time.

- Children do not recognize potential dangers from this product. The unassembled product must be stored out of reach of children and pets.
- This product may only be used with adult supervision at all times.
- The packaging material is not suitable for children due to choking and suffocation hazards.

## 1.2 RISK OF INJURIES

- Do not use the product if it is damaged or defective. If it is damaged or defective, please contact a qualified technician.
- Check the product before each use. Defective parts must be changed immediately as they can impair the function and the safety of the product.
- No more than one person to use the product at the same time.
- Use the product only on even and non-slipping surfaces. Never use it near water and keep sufficient space around for safety.
- Beware of moving parts such as the springs or elastics, which could catch your arms and legs. Do not place any objects or body parts in the product's openings.

## 1.3 PRODUCT DAMAGE

- Do not make alterations to the product. Only use original spare parts. Qualified technicians should only carry out repairs – improper repairs can lead to danger for the user. Use this product only as described in this manual.

## 1.4 ASSEMBLY ADVICE

- The assembly of the product must be done carefully and by an able-bodied adult. If in any doubt, ask a technically qualified person.
- Before you start with the assembly, read the instructions carefully.
- Remove all packaging materials and lay down all parts on an open space. This gives you an overview and simplifies the assembly procedure.
- Check with the parts list that all parts are available. Dispose of the packaging material when the assembly is completed.
- Beware that when using tools or doing technical work, there is always a risk of injuries. Assemble the product with care.
- Create a danger free environment; for example, do not let tools lay around the workspace. Store the packaging material in a way that cannot cause any danger.
- After installing the product according to the instruction manual, ensure all screws, bolts and nuts are correctly installed and tightened and that all joints are secure.
- Reasonable space must be kept between the product and possible sources of danger, such as other equipment swimming pools and fences.
- The assembly of the product must be done carefully and by an able-bodied adult. If in any doubt, ask a technically qualified person.
- The product must be assembled correctly before use.
- Your play structure must be installed on a flat horizontal surface with a minimum of 2m between it and any structure or obstacle such as a fence, garage house, tree branches, cloths lines, or electric cables.
- Modifications made to the original product shall be carried out according to the instructions of the manufacturer.
- The product must always be used in a well-lit area.
- Do not place anything under the product.
- Use gloves during assembly and disassembly.
- Outdoor products should be equipped with a device that in strong wind conditions avoid displacement due to wind (e.g. steel bars in the ground or loads like sand bag or water bags).
- In certain areas during winter, snow buildup and the low temperatures can damage the product. It is recommended to remove snow buildup and to store the product indoor.
- We strongly recommend visual inspections every 3 months to insure the integrity of the entire product. Replace any parts as necessary.

---

## II. SAFETY INSTRUCTIONS

- The safety instructions of the product should always be considered and obeyed.
- Using the product may result in permanent injury such as paralysis, or even death. Falling off the product may lead to injuries, particularly to the back, neck or head.
- No clothes with hooks or loose parts should be worn or carried during product usage in order to avoid hooks getting caught and causing injury.
- Strong winds can result in the product being blown away or damaged. If strong winds are predicted the product must be disassembled and moved to a sheltered area or sufficiently anchored down.
- Moving the product whilst assembled may affect the integrity of the frame. Should it be necessary to move the product, please consider the following:
  1. Force to be evenly spaced around the frame to lift the product off the ground
  2. The product must be carried horizontally
  3. Use caution whilst moving as it could bend the product frame.
- Users should be familiar with the assembly manual. This manual contains assembly guidance; selected precautionary measures as well as recommendations for servicing and maintenance of the product, in order to ensure a secured and fun use of the product.
- Wear clothing free of drawstrings hooks loops or anything that could get caught in the basketball set or safety enclosure.
- It is the responsibility of the owner or the supervisor to guarantee that all users of the product are informed sufficiently of all warning references and safety instructions.

### For the supervisor

The supervisor's role is to make sure users are aware of all safety precautions and that these precautions are enforced. When a supervisor is not available, the product may be disassembled or covered to limit access.

- The product can be only used if it is in good condition, worn or damaged parts should be replaced.
- Objects, which could be dangerous to the user, should be away from the product.
- Avoid unauthorized and unsupervised use of the product.
- Do not use the product under influence of alcohol or drugs (incl. medicines).
- Do not use the product as a jumping platform for other articles.

## Consumer Information Sheet for Playground Surfacing Materials

The US Consumer Product Safety Commission (CPSC) estimates that about 100 000 playground equipment-related injuries resulting from falls to the ground surface are treated annually in US hospital emergency rooms. Injuries involving this hazard pattern tend to be among the most serious of all playground injuries, and have the potential to be fatal, particularly when the injury is to the head. The surface under and around playground equipment can be a major factor in determining the injury-causing potential of a fall. It is self-evident that a fall on to a shock-absorbing surface is less likely to cause a serious injury than a fall onto a hard surface. Playground equipment should never be placed on hard surfaces, such as concrete or asphalt, and while grass may appear to be acceptable, it may quickly turn to hard-packed earth in areas of high traffic. Shredded bark mulch, wood chips, fine sand or the gravel are considered to be acceptable shock absorbing surfaces when installed and maintained at a sufficient depth under and around playground equipment.

**Table B.1** Lists the maximum height from which a child would not be expected to sustain a life-threatening head injury in a fall on to four different loose-fill surfacing materials if they are installed and maintained at depths of 150 mm, 225 mm and 300 mm.

**Table B.1** Fall height in millimetres from which a life-threatening head injury would not be expected.

Type of Material	Depth of surfacing material		
	150mm	225mm	300mm
Double Shredded Bark Mulch	1800	3000	3300
Wood Chips	1800	2100	3600
Fine Sand	1500	1500	2700
Fine Gravel	1800	2100	3000

However, it should be recognised that all injuries due to falls cannot be prevented, no matter what surfacing material is used.

It is recommended that a shock absorbing material extend a minimum of 1 800 mm in all directions from the perimeter of stationary equipment such as climbing frames and slides. However, because children may deliberately jump from a moving swing, the shock absorbing material should extend in the front and rear of a swing a minimum distance of twice the height of the pivot point measured from a point directly beneath the pivot on the supporting structure.

This information is intended to assist in comparing the relative shock-absorbing properties of various materials. No particular material is recommended over another. However, each material is only effective when properly maintained. Materials should be checked periodically and replenished to maintain correct depth as determined necessary for the equipment in question. The choice of a material depends on the type and height of the playground equipment, the availability of the material in a particular area, and its cost.

---





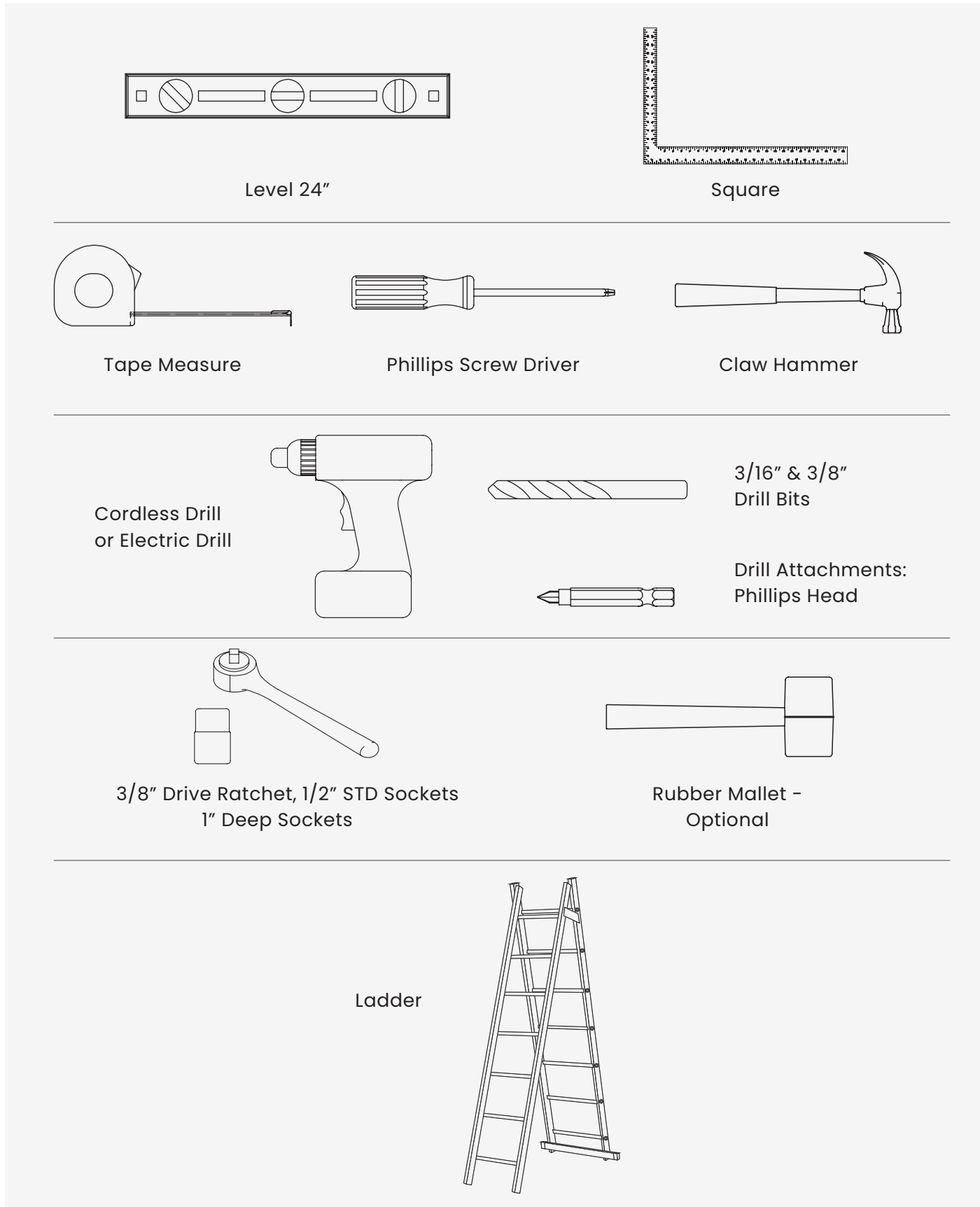



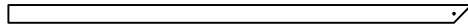
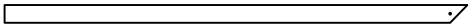

### III. TOOLS REQUIRED FOR INSTALLATION

These are the tools that are generally required for assembly of our outdoor products. These tools are not included with the outdoor product purchase.

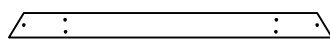
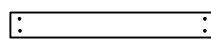
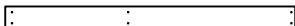

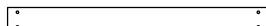
# PARTS IDENTIFICATION

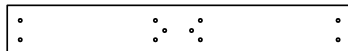
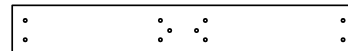
Wood Components (NOT TO SCALE)

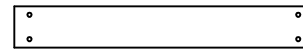
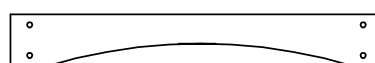
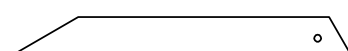
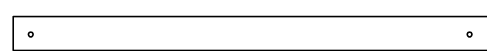
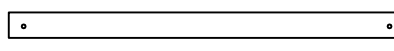
<p><b>1L</b></p> <p>2274 x 85.7 x 34.5 = 1 pc.</p> 	<p><b>1R</b></p> <p>2274 x 85.7 x 34.5 = 1 pc.</p> 	
<p><b>2L</b></p> <p>2274 x 85.7 x 34.5 = 1 pc.</p> 	<p><b>2R</b></p> <p>2274 x 85.7 x 34.5 = 1 pc.</p> 	
<p><b>3L</b></p> <p>1966 x 85.7 x 34.5 = 1 pc.</p> 	<p><b>3R</b></p> <p>1966 x 85.7 x 34.5 = 1 pc.</p> 	
<p><b>4L</b></p> <p>1470 x 112 x 15.8 = 1 pc.</p> 	<p><b>4R</b></p> <p>920 x 112 x 15.8 = 1 pc.</p> 	
<p><b>5</b></p> <p>1425 x 112 x 15.8 = 2 pcs.</p> 	<p><b>6L</b></p> <p>920 x 85.7 x 23.5 = 1 pc.</p> 	<p><b>6R</b></p> <p>920 x 85.7 x 23.5 = 1 pc.</p> 
<p><b>7</b></p> <p>920 x 85.7 x 23.5 = 2 pcs.</p> 	<p><b>8L</b></p> <p>1456 x 85.7 x 23.5 = 1 pc.</p> 	<p><b>8R</b></p> <p>1456 x 85.7 x 23.5 = 1 pc.</p> 
<p><b>9L</b></p> <p>920 x 134 x 34.5 = 1 pc.</p> 	<p><b>9R</b></p> <p>952 x 85.7 x 34.5 = 1 pc.</p> 	
<p><b>10</b></p> <p>858.4 x 85.7 x 23.5 = 4 pcs.</p> 	<p><b>11</b></p> <p>608 x 85.7 x 16 = 1 pc.</p> 	
<p><b>12</b></p> <p>608 x 85.7 x 15.8 = 1 pc.</p> 	<p><b>13</b></p> <p>541.52 x 60 x 23.5 = 2 pcs.</p> 	
<p><b>14</b></p> <p>850.7 x 60 x 23.5 = 1 pc.</p> 	<p><b>15</b></p> <p>920 x 60 x 15.8 = 1 pc.</p> 	



16

710 x 60 x 23.5 = 4 pcs.

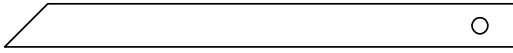

17

330 x 85.7 x 23.5 = 2 pcs.

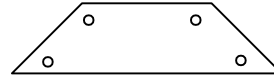

18

240 x 60 x 24 = 8 pcs.

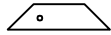

19

1408 x 60 x 34.5 = 1 pc.

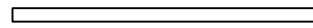

20A

967 x 103 x 15.8 = 1 pc.

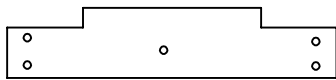

20B

967 x 103 x 15.8 = 2 pcs.

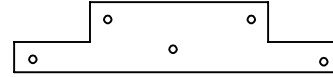

20C

967 x 103 x 15.8 = 1 pc.

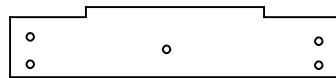

20D

967 x 103 x 15.8 = 10 pcs.

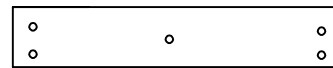

21

650 x 60 x 15.8 = 18 pcs.



22

884 x 118 x 16 = 12 pcs.



23

884 x 78 x 13 = 2 pcs.



24L

1220 x 85.7 x 23.5 = 1 pc.



24R

1220 x 85.7 x 23.5 = 1 pc.



25

400 x 85.7 x 23.5 = 3 pcs.

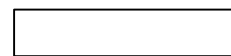

26A

980 x 86 x 10.5 = 1 pc.



26B

980 x 86 x 10.5 = 1 pc.



26C

980 x 51 x 10.5 = 1 pc.

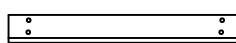

26D

980 x 51 x 10.5 = 1 pc.

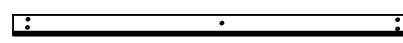

26E

980 x 86 x 10.5 = 6 pcs.

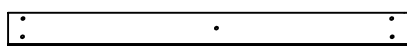

27A

480 x 86 x 10.5 = 8 pcs.

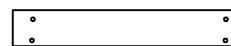

**27B**

$480 \times 59 \times 10.5 = 1 \text{ pc.}$



**27C**

$480 \times 59 \times 10.5 = 1 \text{ pc.}$

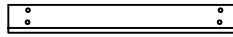

**29**

$582 \times 34.5 \times 24 = 2 \text{ pcs.}$

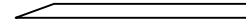

**30L**

$2373 \times 85.7 \times 34.5 = 1 \text{ pc.}$

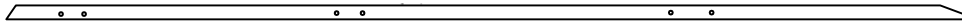

**30R**

$2373 \times 85.7 \times 34.5 = 1 \text{ pc.}$

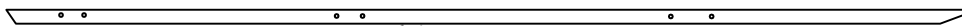

**31**

$296.22 \times 85.7 \times 23.5 = 2 \text{ pcs.}$

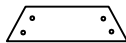

**32**

$2207.14 \times 85.7 \times 23.5 = 1 \text{ pc.}$



**33**

$1322.18 \times 85.7 \times 23.5 = 1 \text{ pc.}$

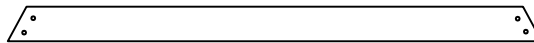

**34**

$2438 \times 133.5 \times 50 = 1 \text{ pc.}$



**35**

$85.7 \times 85.7 \times 34.5 = 1 \text{ pc.}$



**36L**

$1950 \times 85.7 \times 50 = 1 \text{ pc.}$



**36R**

$1950 \times 85.7 \times 50 = 1 \text{ pc.}$

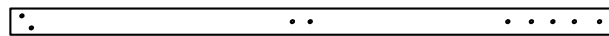

**37L**

$1880 \times 85.7 \times 50 = 1 \text{ pc.}$

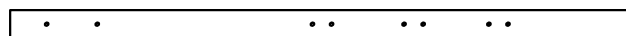

**37R**

$1880 \times 85.7 \times 50 = 1 \text{ pc.}$

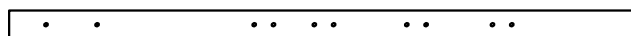

**38**

$1220 \times 85.7 \times 50 = 1 \text{ pc.}$

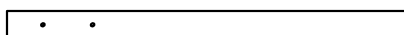

**28**

$765 \times 254 \times 32 = 1 \text{ pc.}$

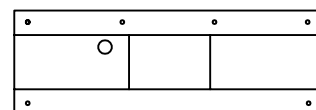

# PARTS IDENTIFICATION

Hardware (NOT TO SCALE)

**A** x 16pcs.

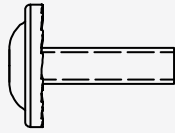

BOLT M8\*30

**B** x 57pcs.

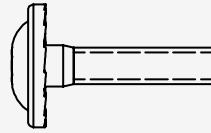

BOLT M8\*45

**C** x 16pcs.

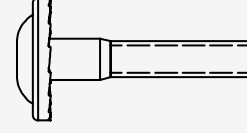

BOLT M8\*50

**D** x 8pcs.

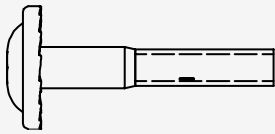

BOLT M8\*65

**E** x 2pcs.

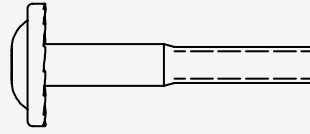

BOLT M8\*80

**F** x 12pcs.

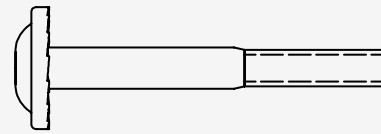

BOLT M8\*100

**G** x 98+4pcs.

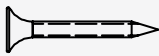

SCREW M3\*20

**H** x 160+10pcs.

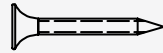

SCREW M3\*35

**I** x 18pcs.

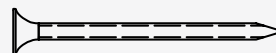

SCREW M3\*50

**J** x 8pcs.

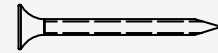

SCREW M5\*45

**O** x 2pcs.

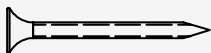

SCREW M3.5\*40

**X** x 2pcs.

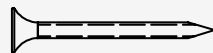

SCREW M5\*30

**K** x 14pcs.

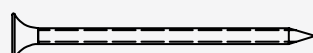

SCREW M5\*60

**L** x 88pcs.

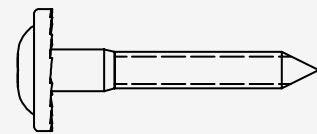

LAG SCREW M8\*50

**Z** x 111+4pcs.

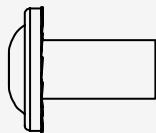

NUT BARREL 8\*25

**M** x 4pcs.

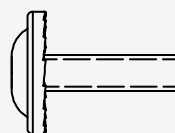

BOLT M8\*20

**Y** x 4pcs.

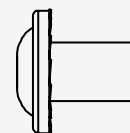

NUT BARREL M8\*20

**N1** x 6pcs.



NUT LOCK

**N2** x 6pcs.



WASHER FLAT

**N3** x 6pcs.



WASHER SAFETY

**N** x 6pcs.

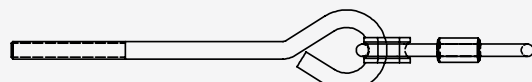

SWING HANGER QUICK LINK

# PARTS IDENTIFICATION

Hardware/Accessories (NOT TO SCALE)

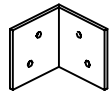

L BRACKET 70\*75\*2 = 4pcs.

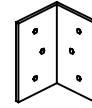

L BRACKET 70\*120\*2 = 2pcs.

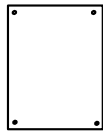

BLACKBOARD = 1pc.

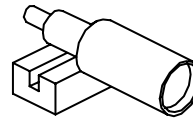

TELESCOPE = 1pc.

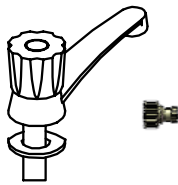

TAP = 1pc.

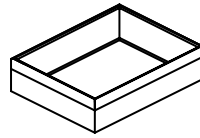

BASIN = 1pc.



HAND GRIP GREEN  
PLASTIC = 2 sets

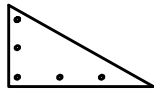

TRIANGLE PLATE  
= 2pcs.

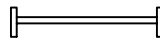

METAL RUNG  
485\*25\*1.5 = 8pcs.

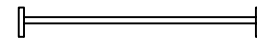

METAL RUNG  
850\*32\*1.5 = 1pc.

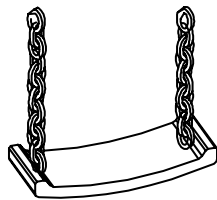

SWING SEAT = 2pcs.

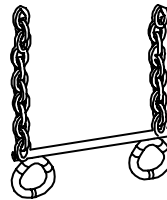

TRAPEZE = 1pc.

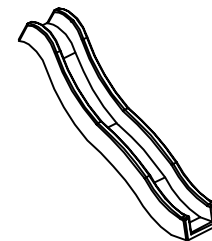

SLIDE = 1pc.



METAL GROUND  
STAKE = 7pcs.

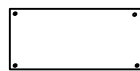

TAG = 1pc.



HEXAGON BIT = 1pc.

HEXAGON WRENCH  
= 1pc.

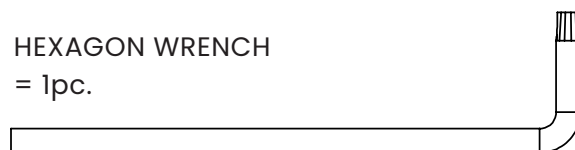

## ROOF

### PHASE NOTES:

Assemble as shown.

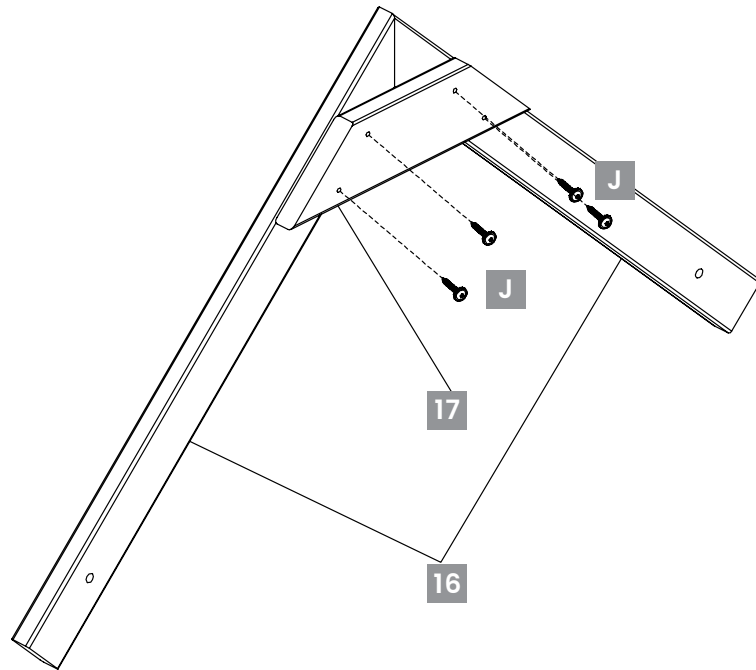

Z1=2

16

710 x 60 x 23.5 = 4

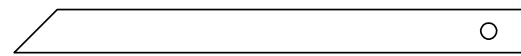

17

330 x 85.7 x 23.5 = 2

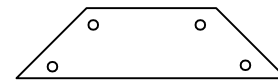

J



x 8

## STAIRS

### PHASE NOTES:

Assemble as shown.

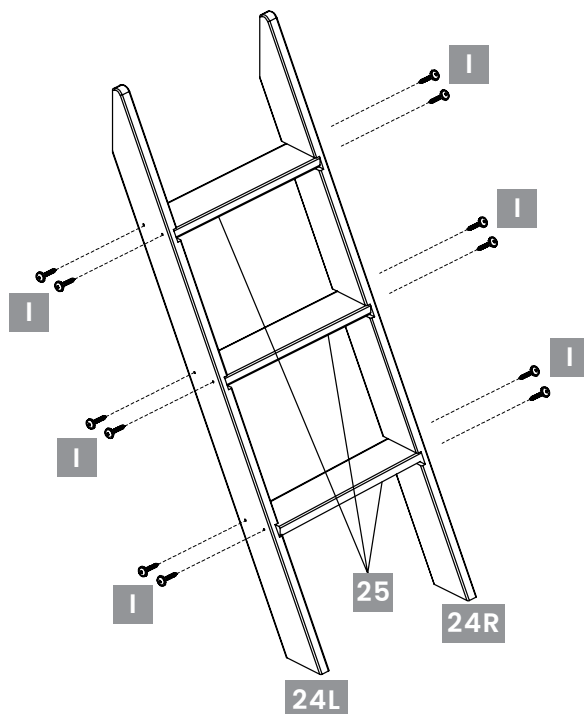

Z2

24L

1220 x 85.7 x 23.5 = 1

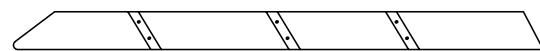

24R

1220 x 85.7 x 23.5 = 1



25

400 x 85.7 x 23.5 = 3

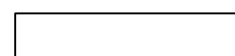

I



x 12

# MONKEY BAR ASSEMBLY

ASSEMBLE AS SHOWN INTO PRE-DRILLED HOLES

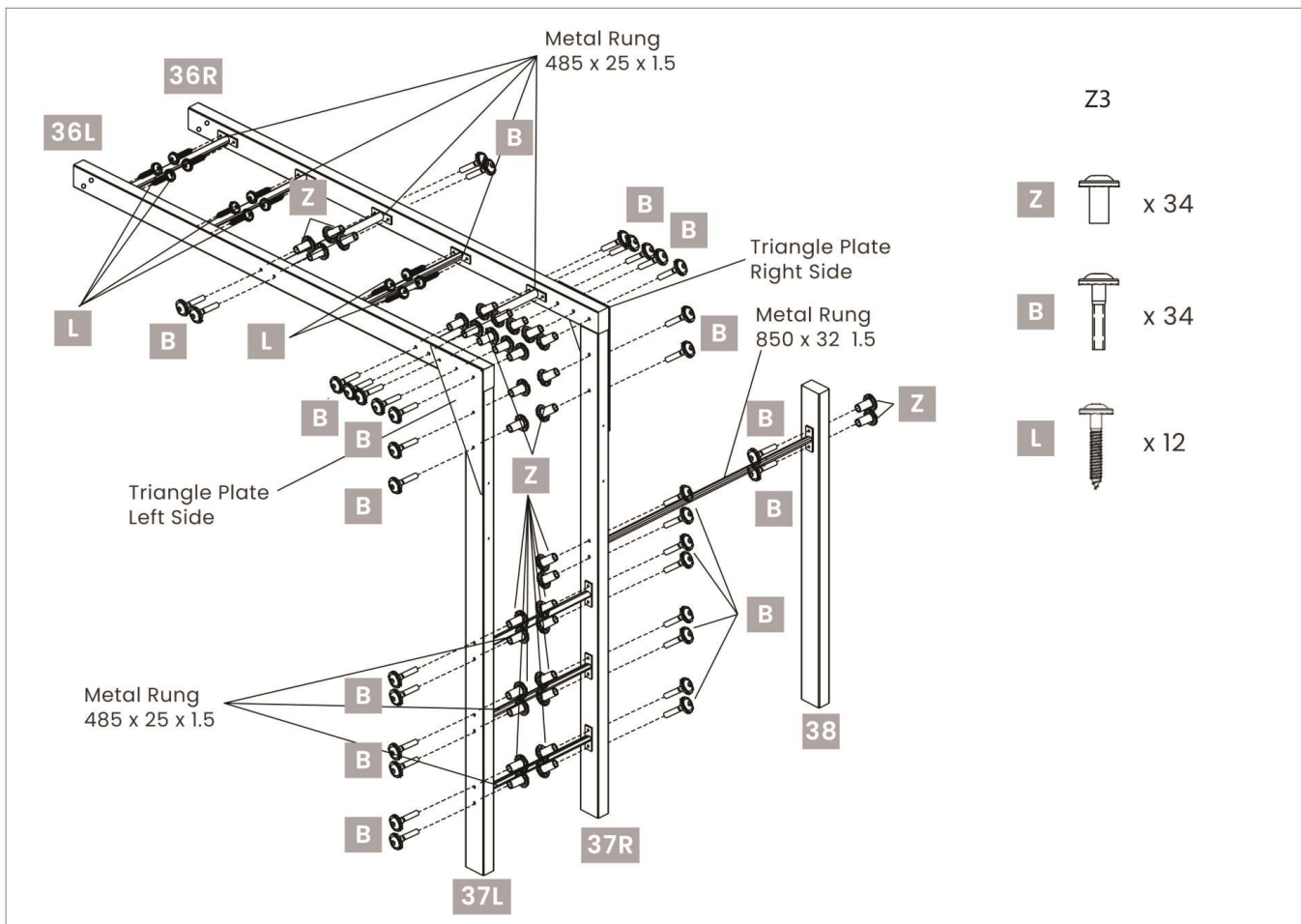
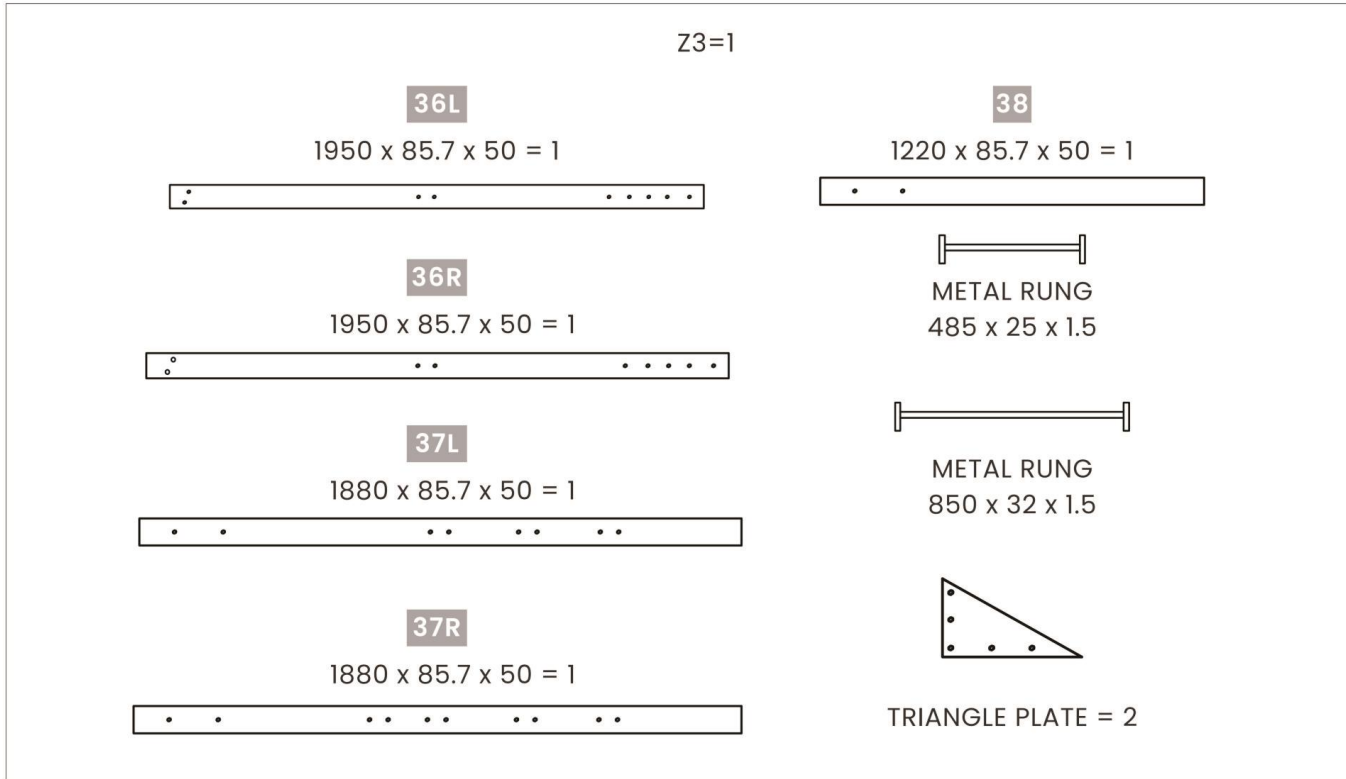

# SWING BEAM ASSEMBLY

## PHASE NOTES:

Step 1: Attach 30L/30R boards swing beam support to 34 board.

Step 2 :Attach 31 board to 30L/30R swing beam support.

Step 3: Attach 32/33 boards to 30L/30R swing beam support.

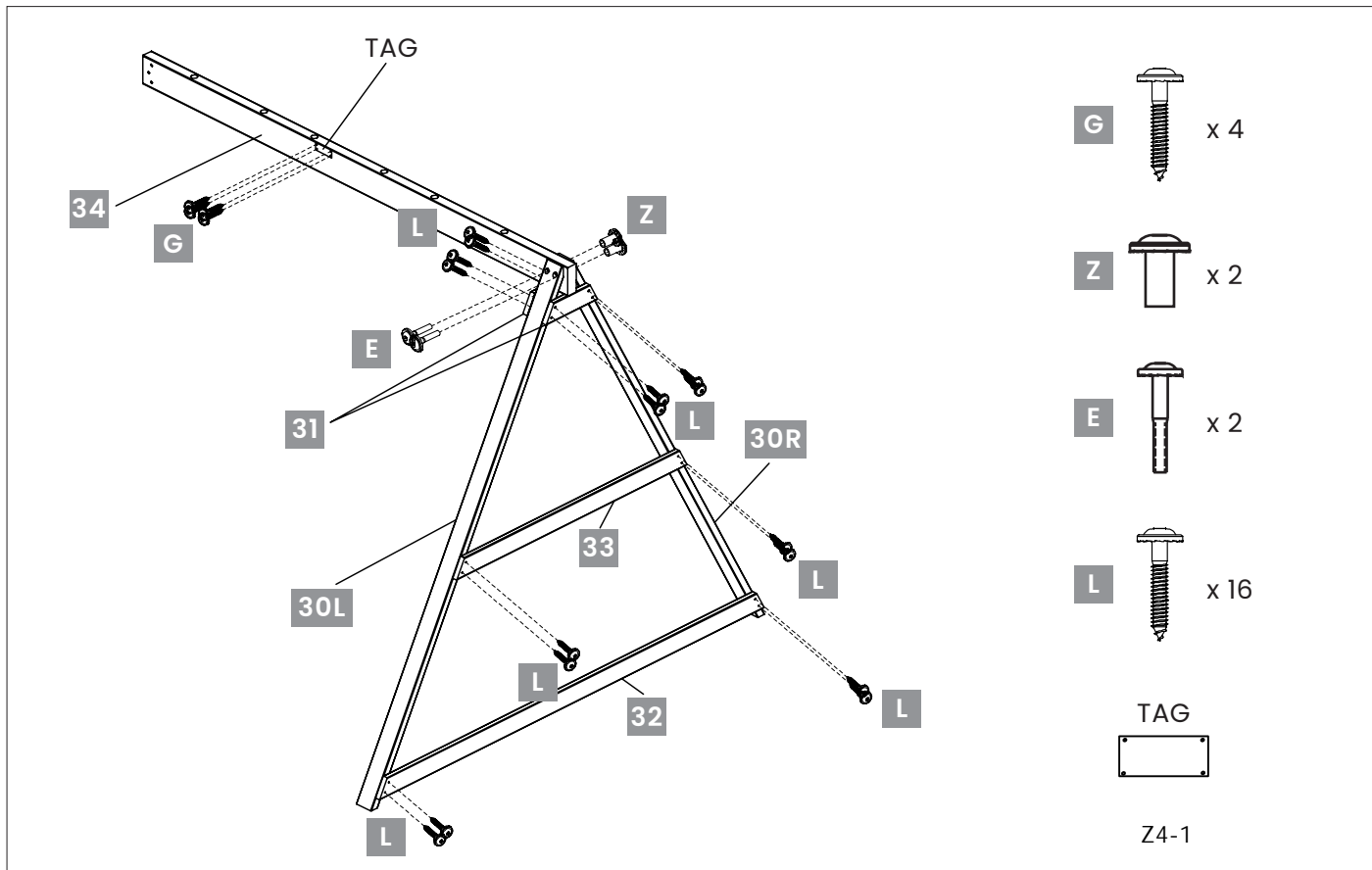
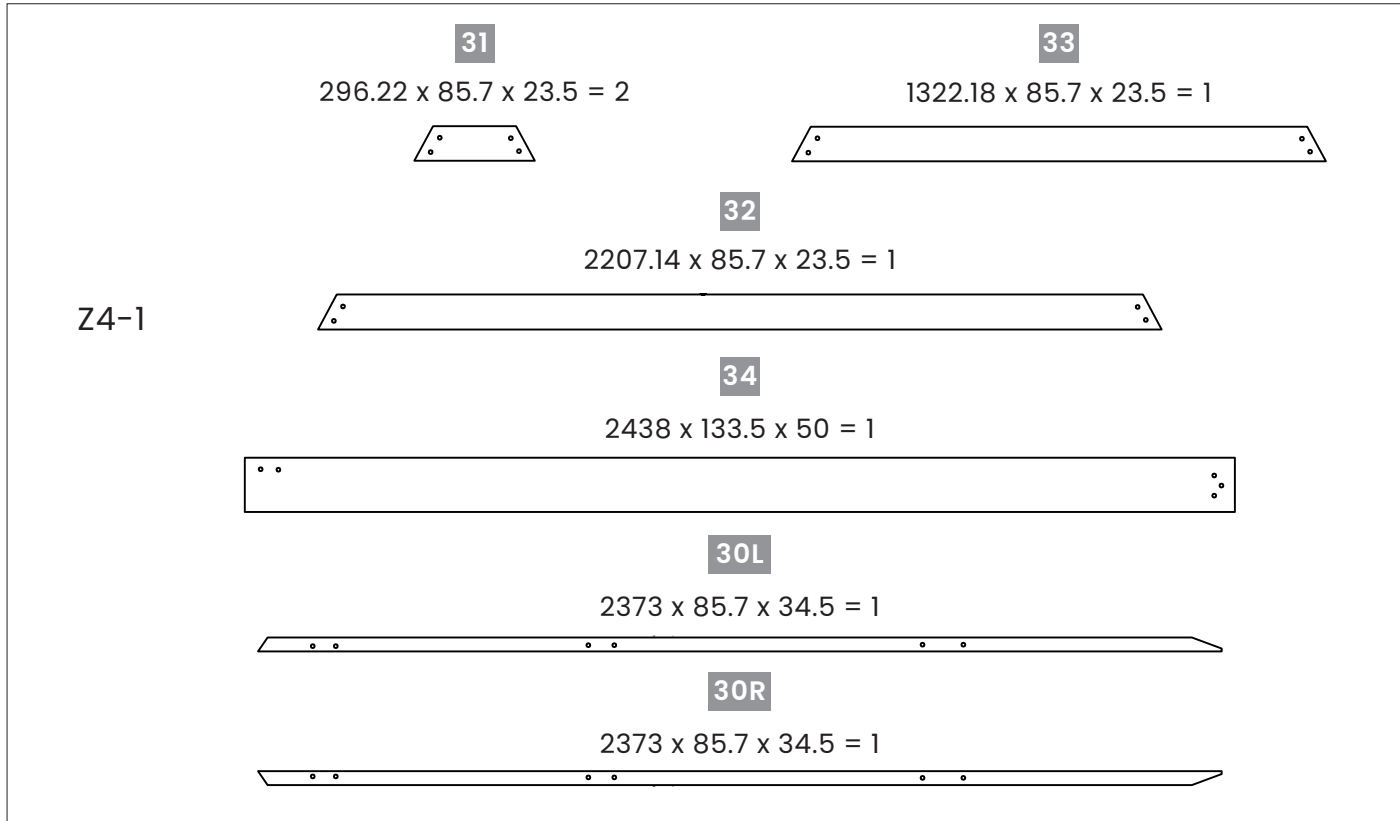

**PHASE NOTES:**

Insert (6) swing hanger quick link into 34 swing beam using (6) safety washers, flat washers and lock nuts, as shown.

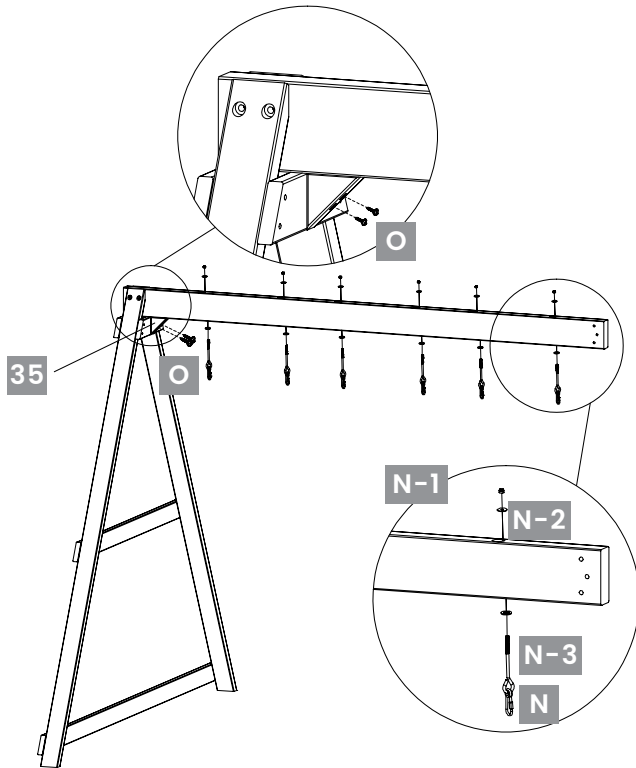

Z4-2

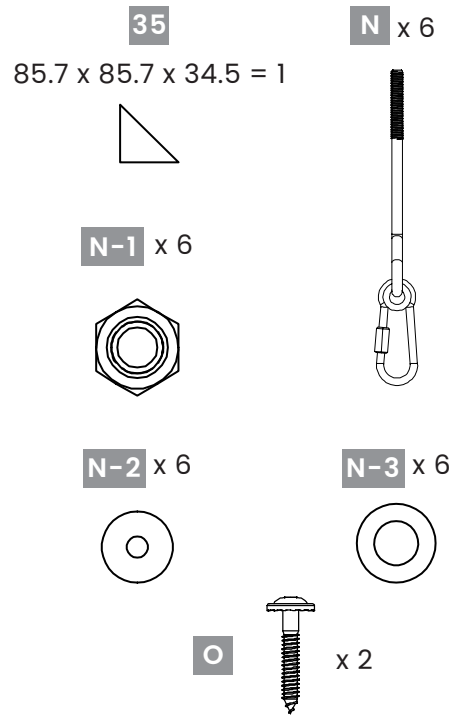

**PHASE NOTES:**

Assemble as shown.

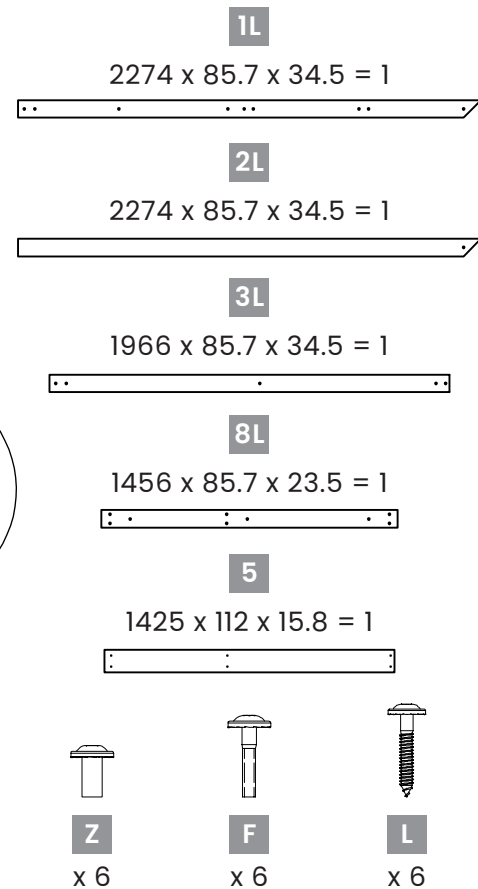
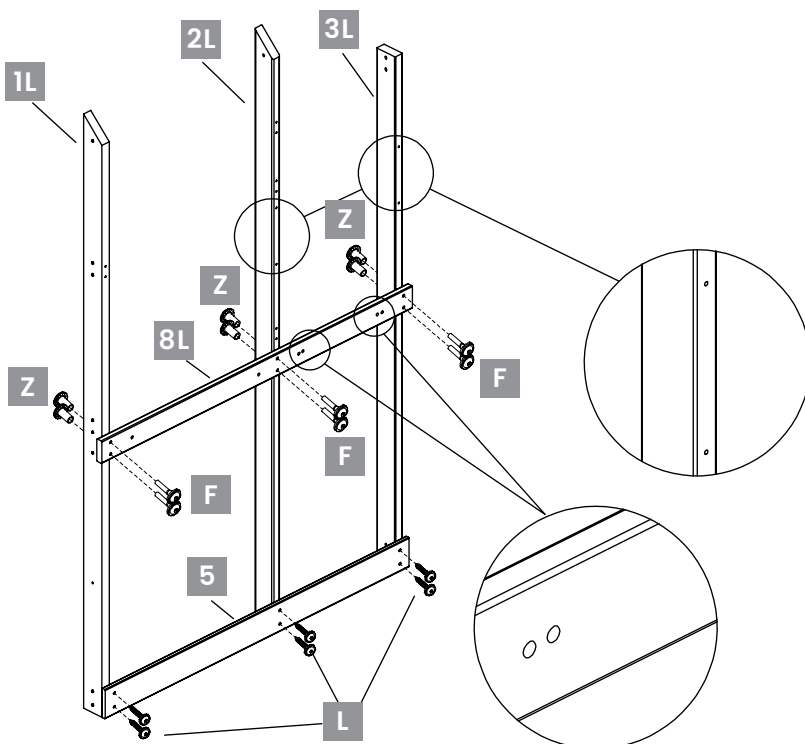



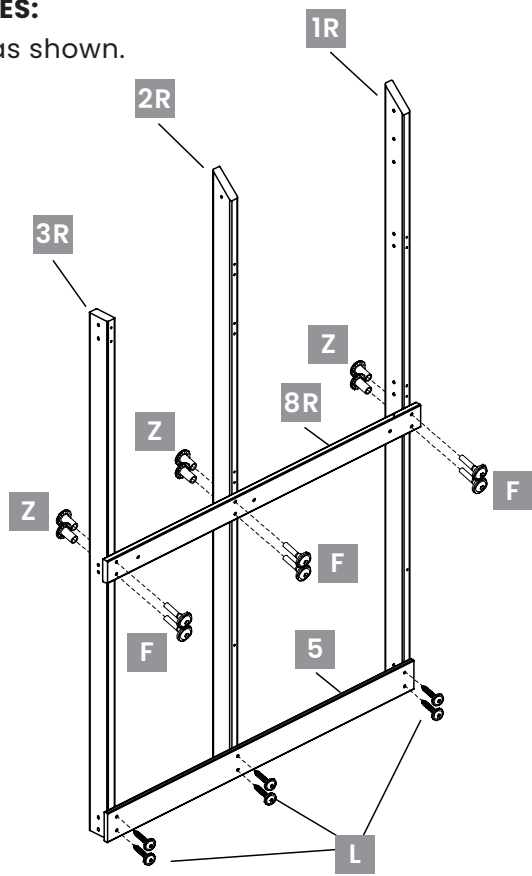

**PHASE NOTES:**

Assemble as shown.





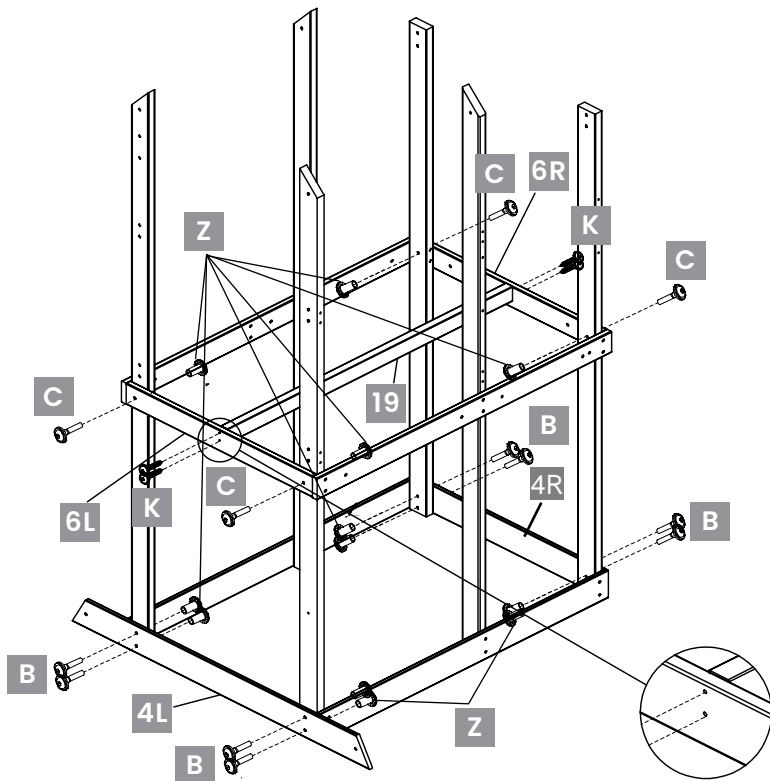

- 1R**  
2274 x 85.7 x 34.5 = 1
  - 2R**  
2274 x 85.7 x 34.5 = 1
  - 3R**  
1966 x 85.7 x 34.5 = 1
  - 8R**  
1456 x 85.7 x 23.5 = 1
  - 5**  
1425 x 112 x 15.8 = 1
- |   |  |  |
|---|--|--|
|  |  |  |
| <b>Z</b>  | <b>F</b>   | <b>L</b>   |
| x 6   | x 6  | x 6  |

**PHASE NOTES:**

Assemble as shown.



- 4L**  
1470 x 112 x 15.8 = 1
  - 4R**  
920 x 112 x 15.8 = 1
  - 6L**  
920 x 85.7 x 23.5 = 1
  - 6R**  
920 x 85.7 x 23.5 = 1
  - 19**  
1408 x 60 x 34.5 = 1
- |          |   |      |          |   |     |
|----------|---|------|----------|---|-----|
| <b>Z</b> |  | x 12 | <b>K</b> |  | x 4 |
| <b>B</b> |  | x 8  | <b>C</b> |  | x 4 |

**PHASE NOTES:**

Attach 18 boards to 6R board/8L board/8R board.

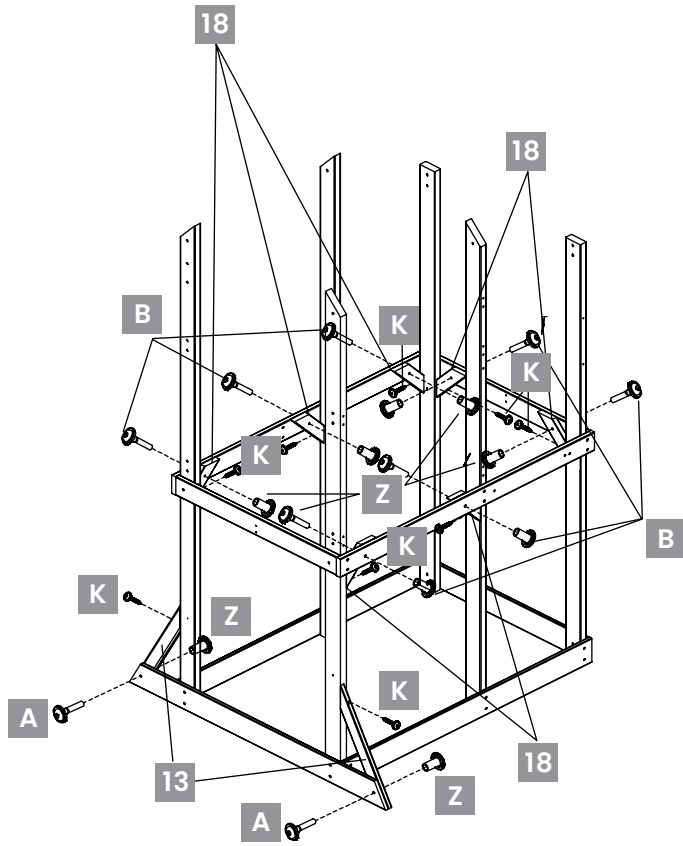

**13**

$$541.52 \times 60 \times 23.5 = 2$$

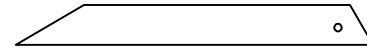

**18**

$$240 \times 60 \times 24 = 7$$

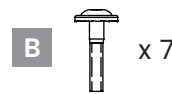
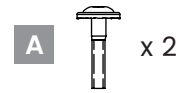
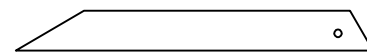

**PHASE NOTES:**

Put 20A board/20B board/20C board on. Don't lock it up yet.

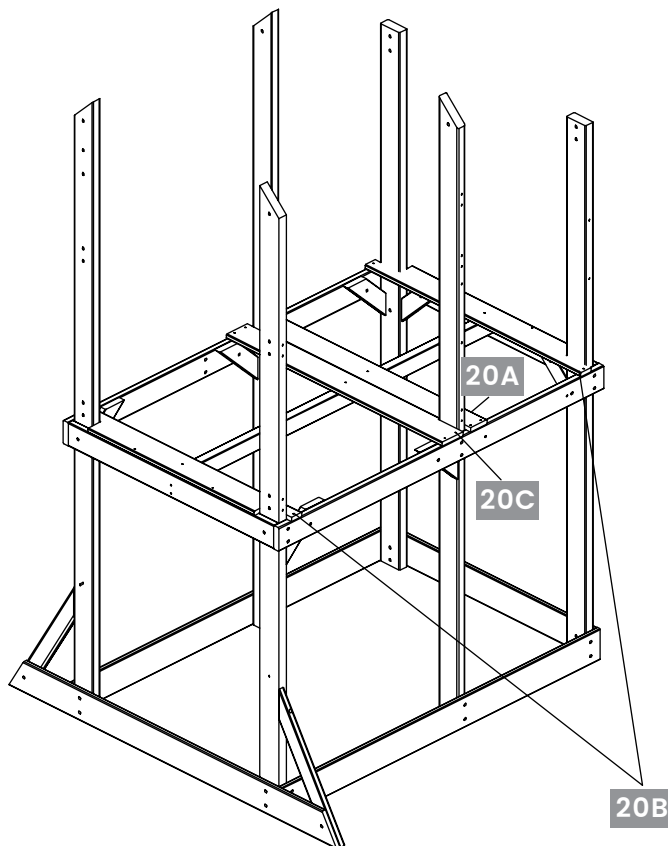

**20A**

$$967 \times 103 \times 15.8 = 1$$

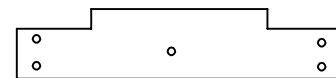

**20B**

$$967 \times 103 \times 15.8 = 2$$

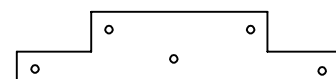

**20C**

$$967 \times 103 \times 15.8 = 1$$

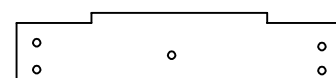

**PHASE NOTES:**

Assemble the FLOOR PANELS as shown.

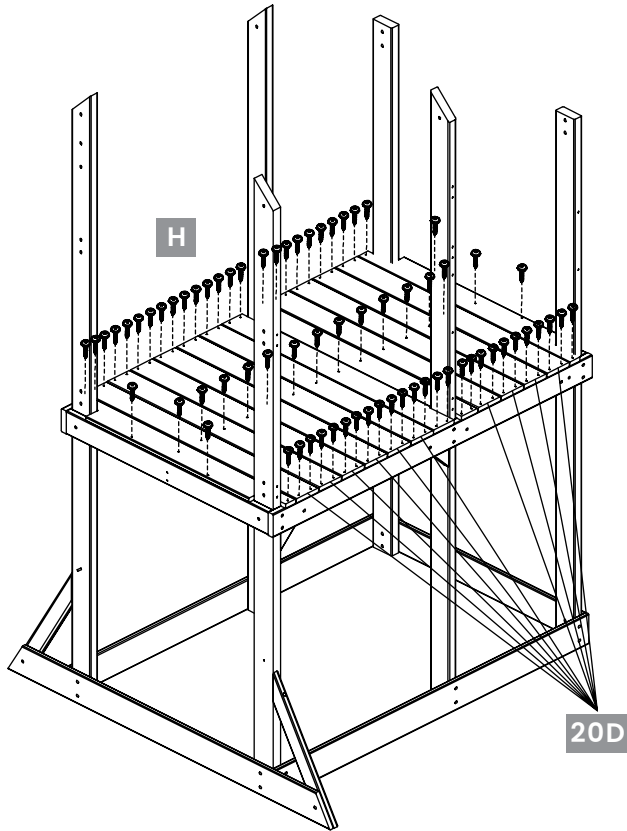

**20D**

967 x 103 x 15.8 = 10

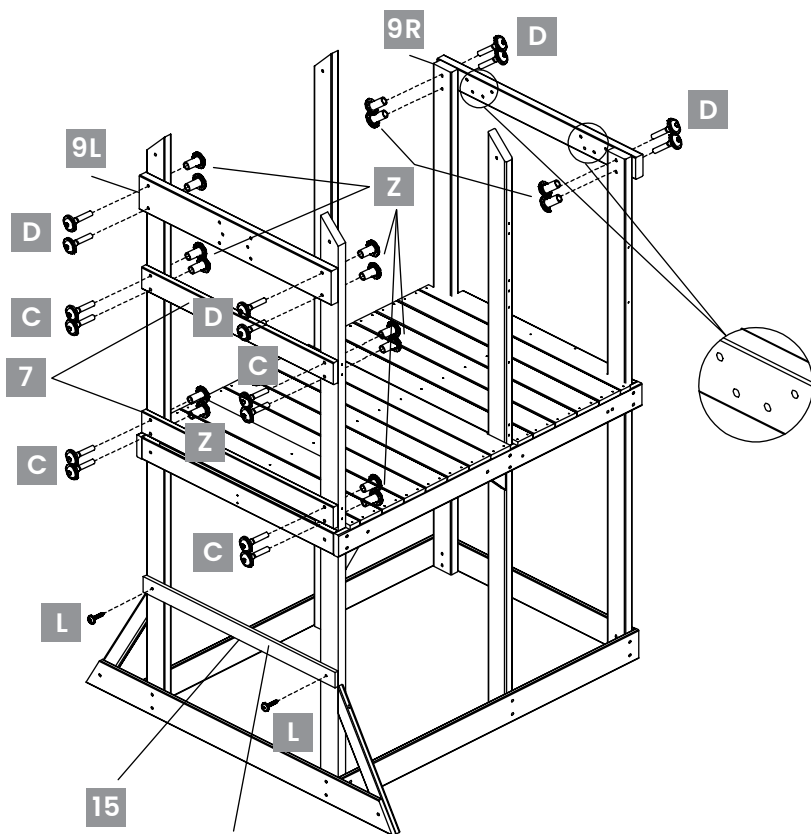
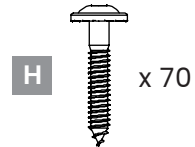
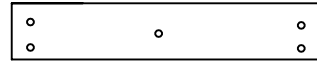

**7**

920 x 85.7 x 23.5 = 2

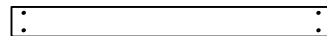

**9R**

952 x 85.7 x 34.5 = 1



**9L**

920 x 134 x 34.5 = 1

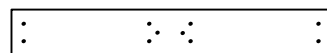

**15**

920 x 60 x 15.8 = 1

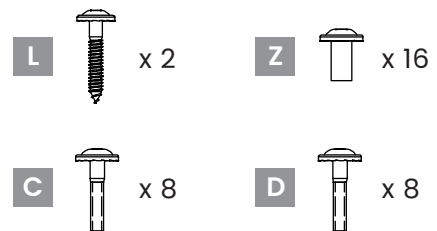
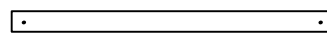

**NOTE:**

15 Board Pre-drilled holes inside.

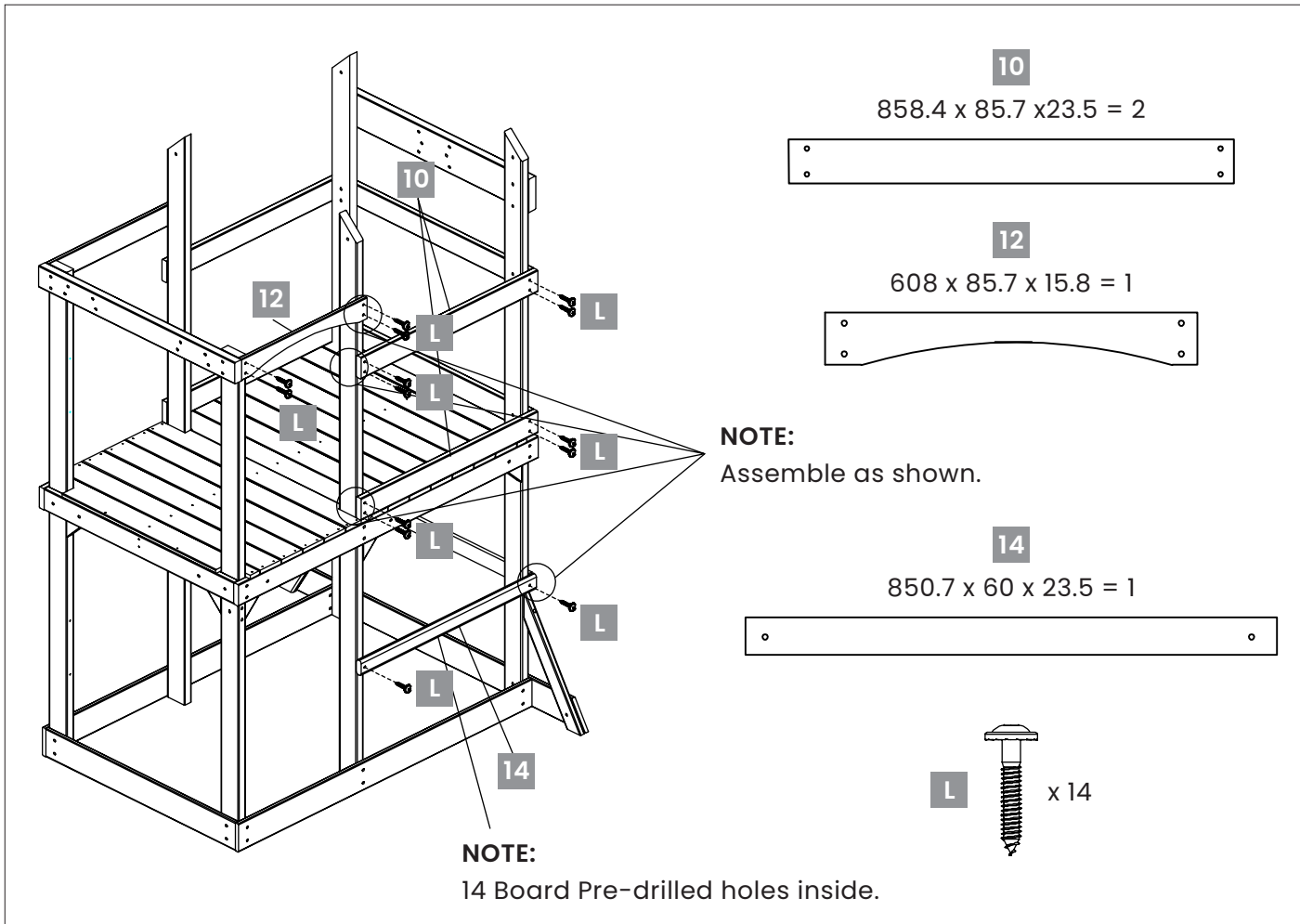
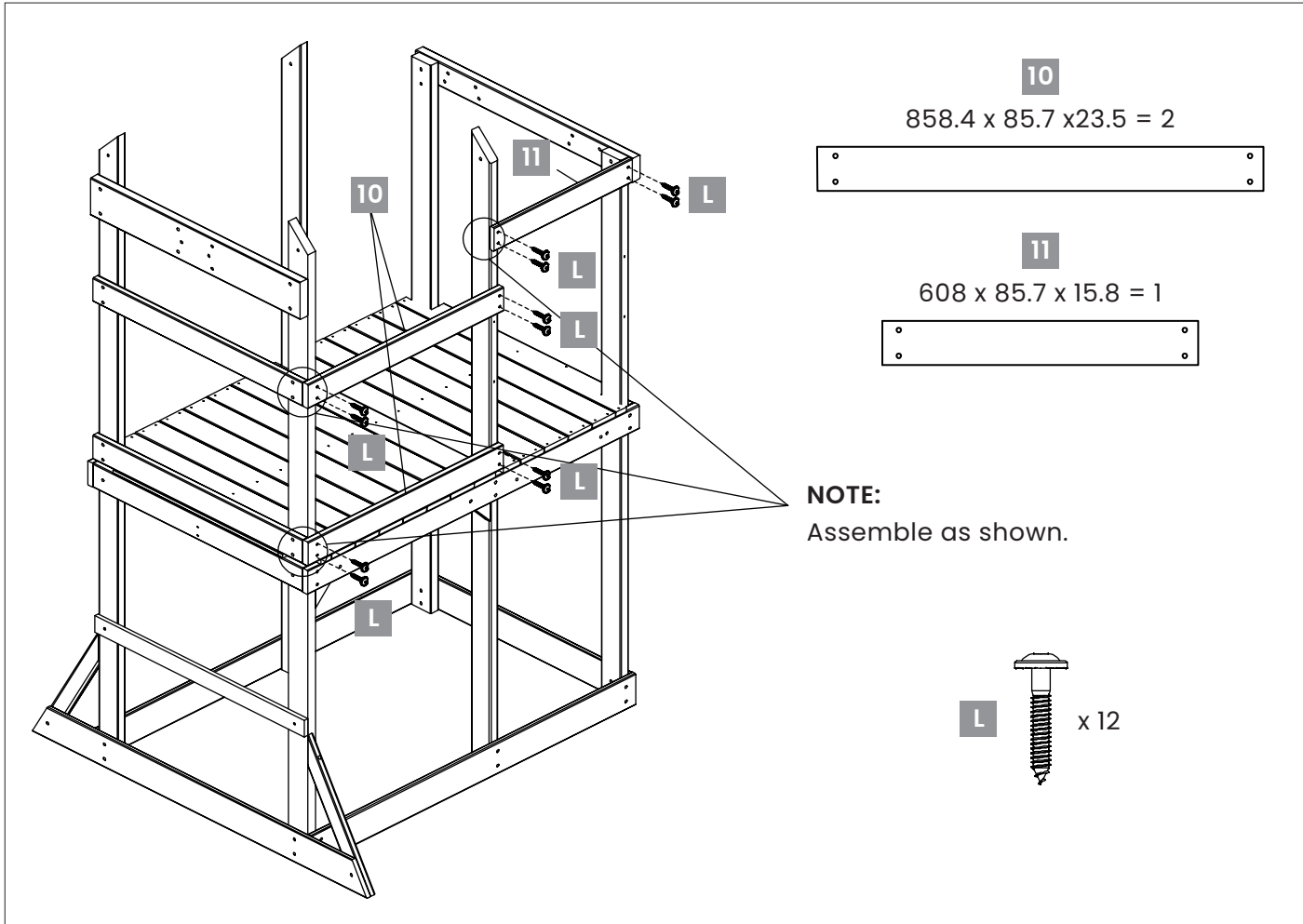

**PHASE NOTES:**

Assemble 21 boards using spacing as shown.

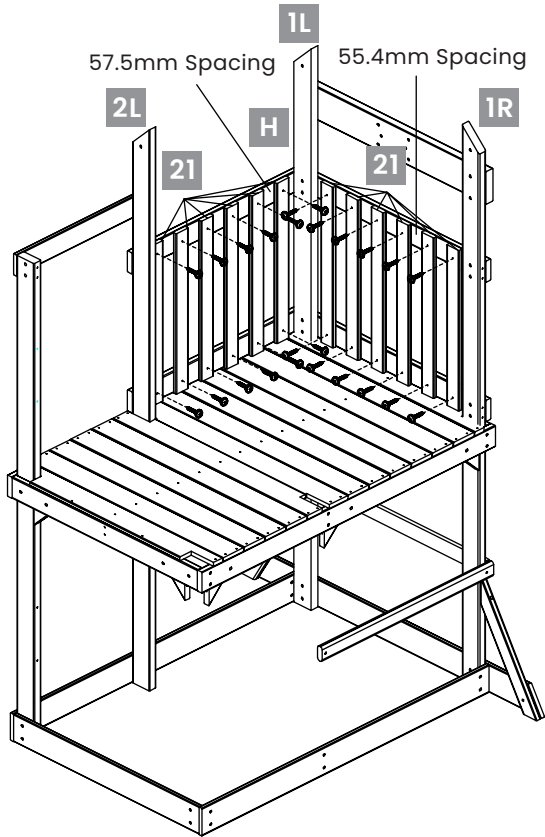

**21**  
650 x 60 x 15.8 = 12

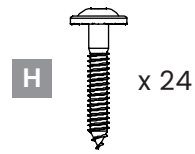
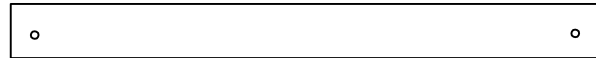

**PHASE NOTES:**

Assemble 21 boards using spacing as shown.

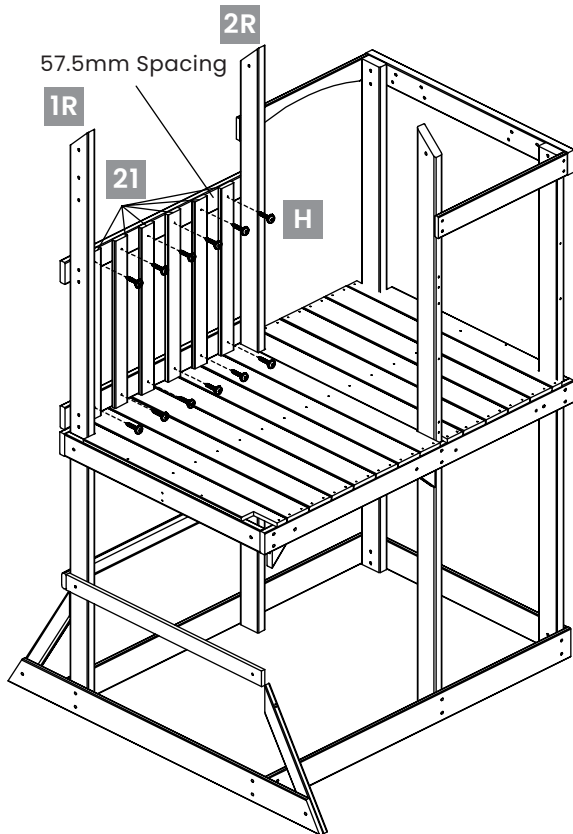

**21**  
650 x 60 x 15.8 = 6

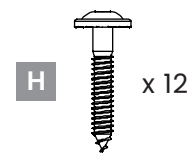

**PHASE NOTES:**

Assemble the roof Z1 as shown.

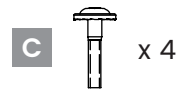
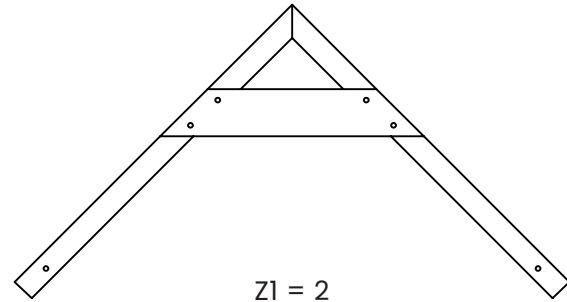
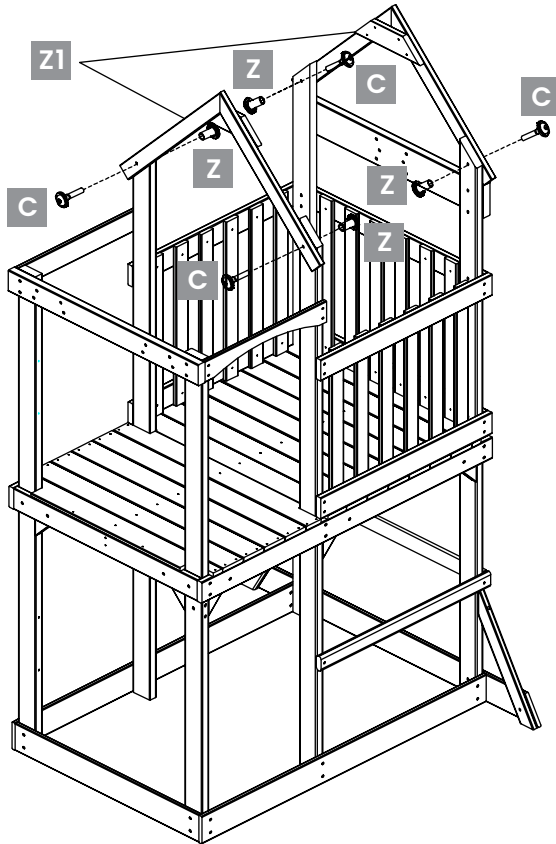

**PHASE NOTES:**

Assemble the roof 22/23 boards as shown.

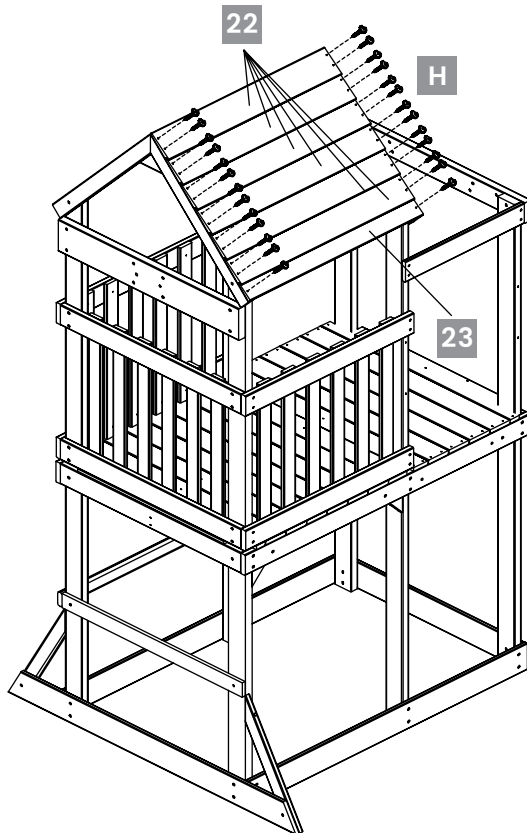

**22**

884 x 118 x 16 = 6

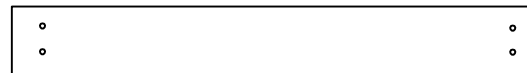

**23**

884 x 78 x 13 = 1

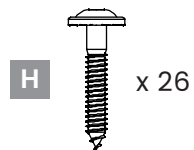
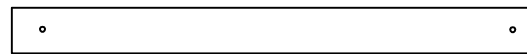

**PHASE NOTES:**

Assemble the roof 22/23 boards as shown.

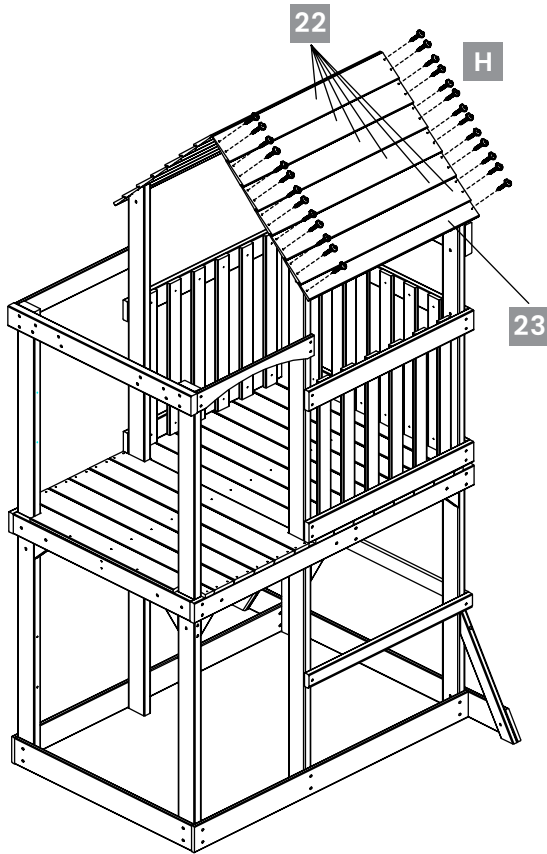

**22**

$$884 \times 118 \times 16 = 6$$



**23**

$$884 \times 78 \times 13 = 1$$

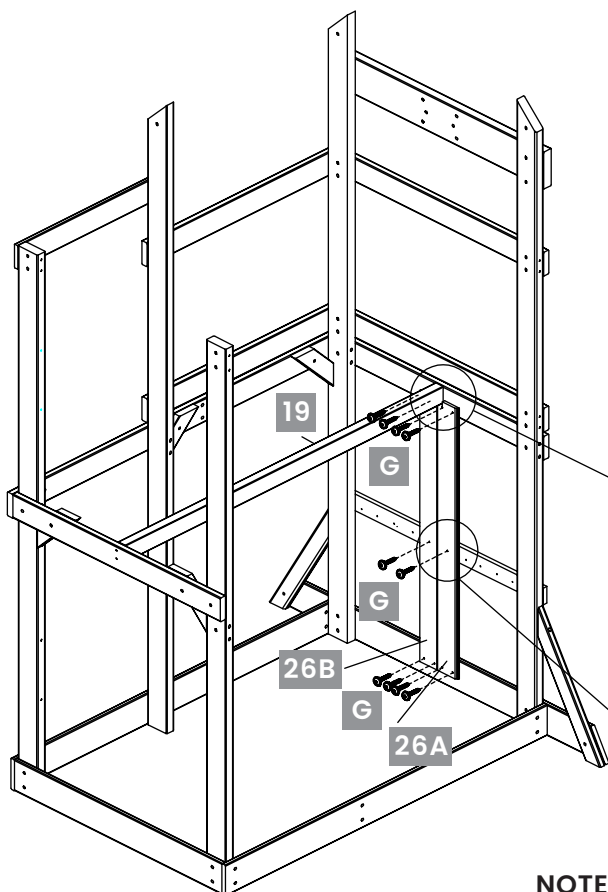
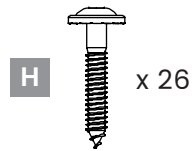
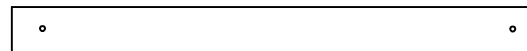

**26A**

$$980 \times 86 \times 10.5 = 1$$

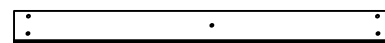

**26B**

$$980 \times 86 \times 10.5 = 1$$



**NOTE:**

Assemble as shown into pre-drilled holes.

**PHASE NOTES:**

Assemble as shown.

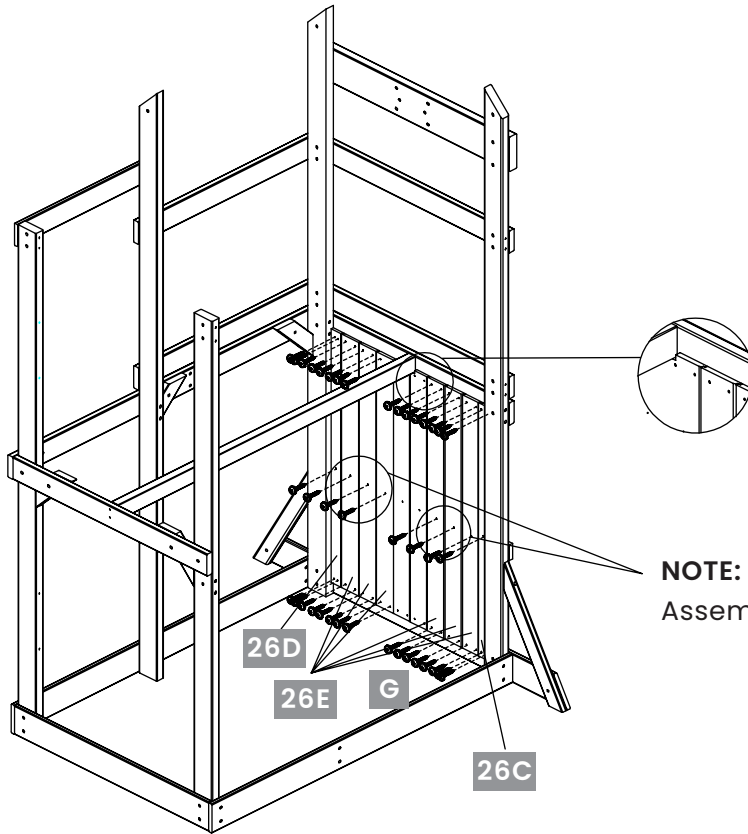

**26C**

980 x 51 x 10.5 = 1



**26D**

980 x 51 x 10.5 = 1



**26E**

980 x 86 x 10.5 = 6

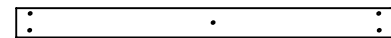

**NOTE:**

Assemble as shown into pre-drilled holes.

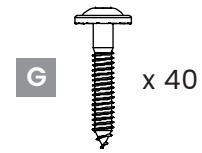

**PHASE NOTES:**

Assemble as shown.

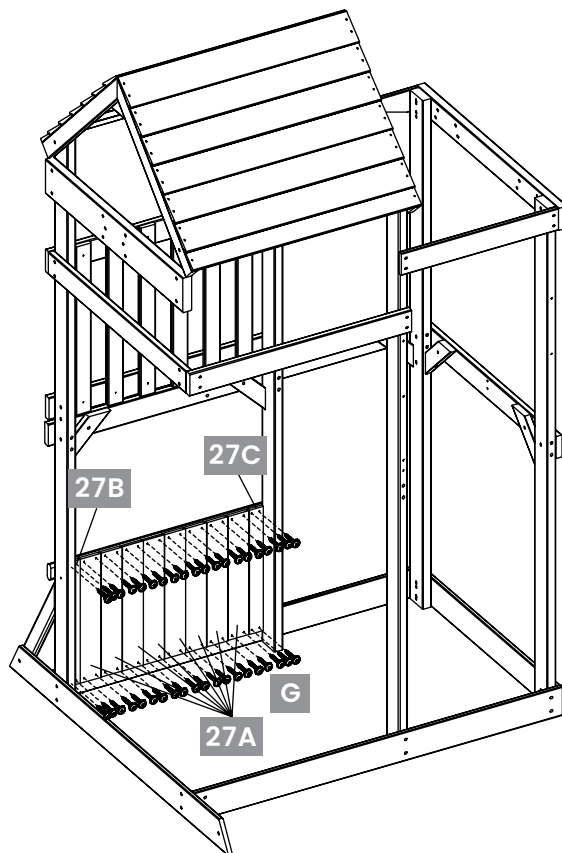

**27A**

480 x 86 x 10.5 = 8



**27B**

480 x 59 x 10.5 = 1

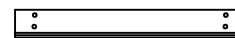

**27C**

480 x 59 x 10.5 = 1

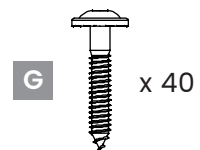
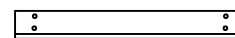



**PHASE NOTES:**

Assemble as shown.

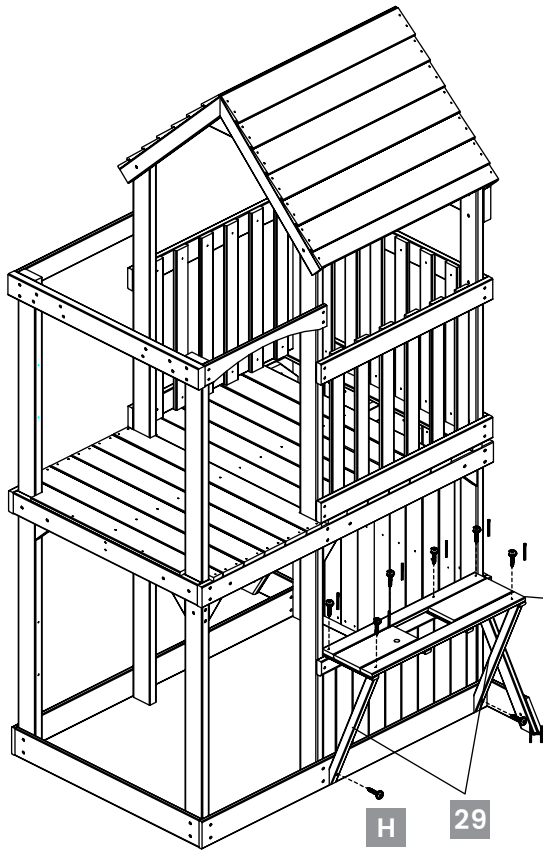

28

765 x 254 x 32 = 1

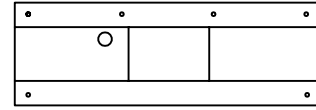

29

582 x 34.5 x 24 = 2

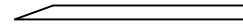

H



x 2

I



x 6

**PHASE NOTES:**

Assemble the stairs Z2 as shown.

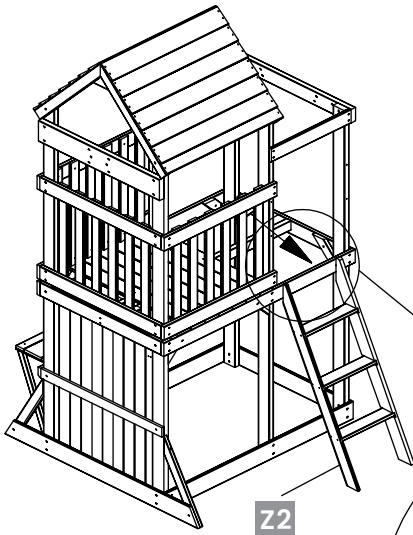

Z2

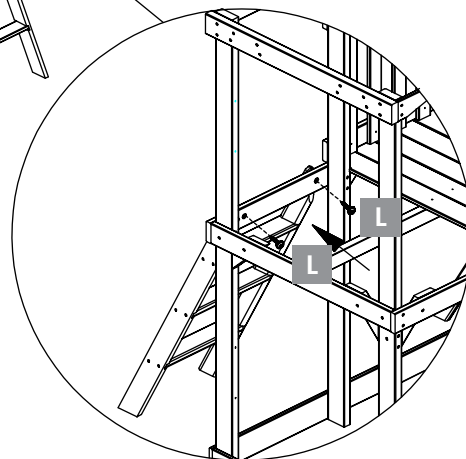

Z2

1220 x 428 x 85.7 = 1

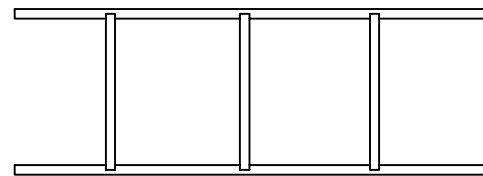

L



x 2

**PHASE NOTES:**

Assemble as shown.

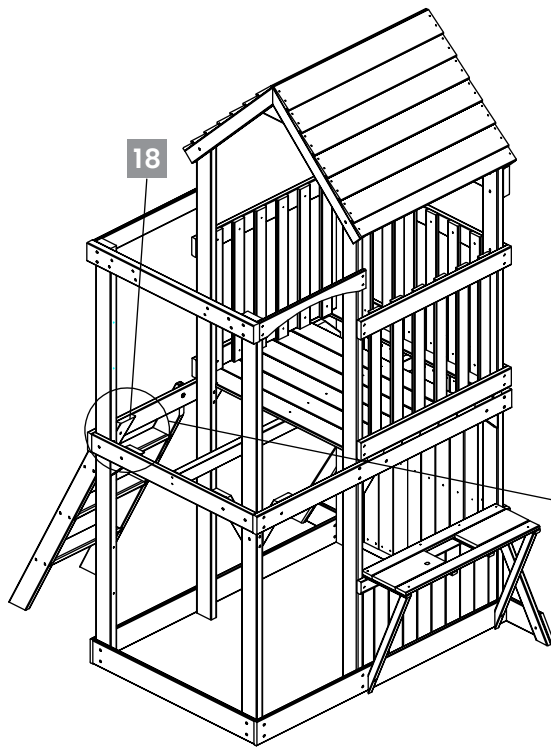

**18**  
240 x 60 x 24 = 1

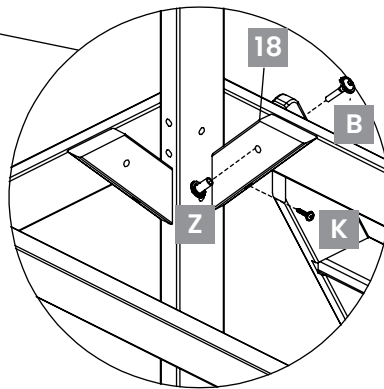
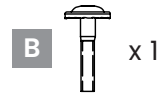

**PHASE NOTES:**

Assemble MONKEY BAR Z3 with L BRACKET 70 x 75 x 2 as shown.

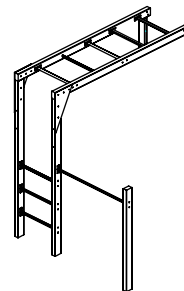
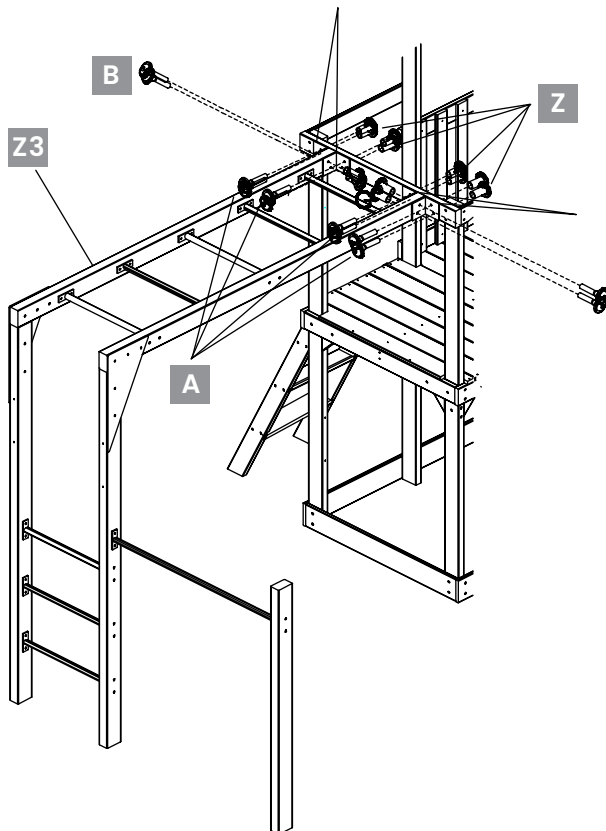

Z3 = 1

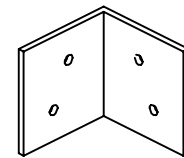

L BRACKET  
70 x 75 x 2 = 4

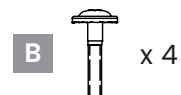

**PHASE NOTES:**

Assemble Z4 with L BRACKET 70 x 120 x 2 as shown.

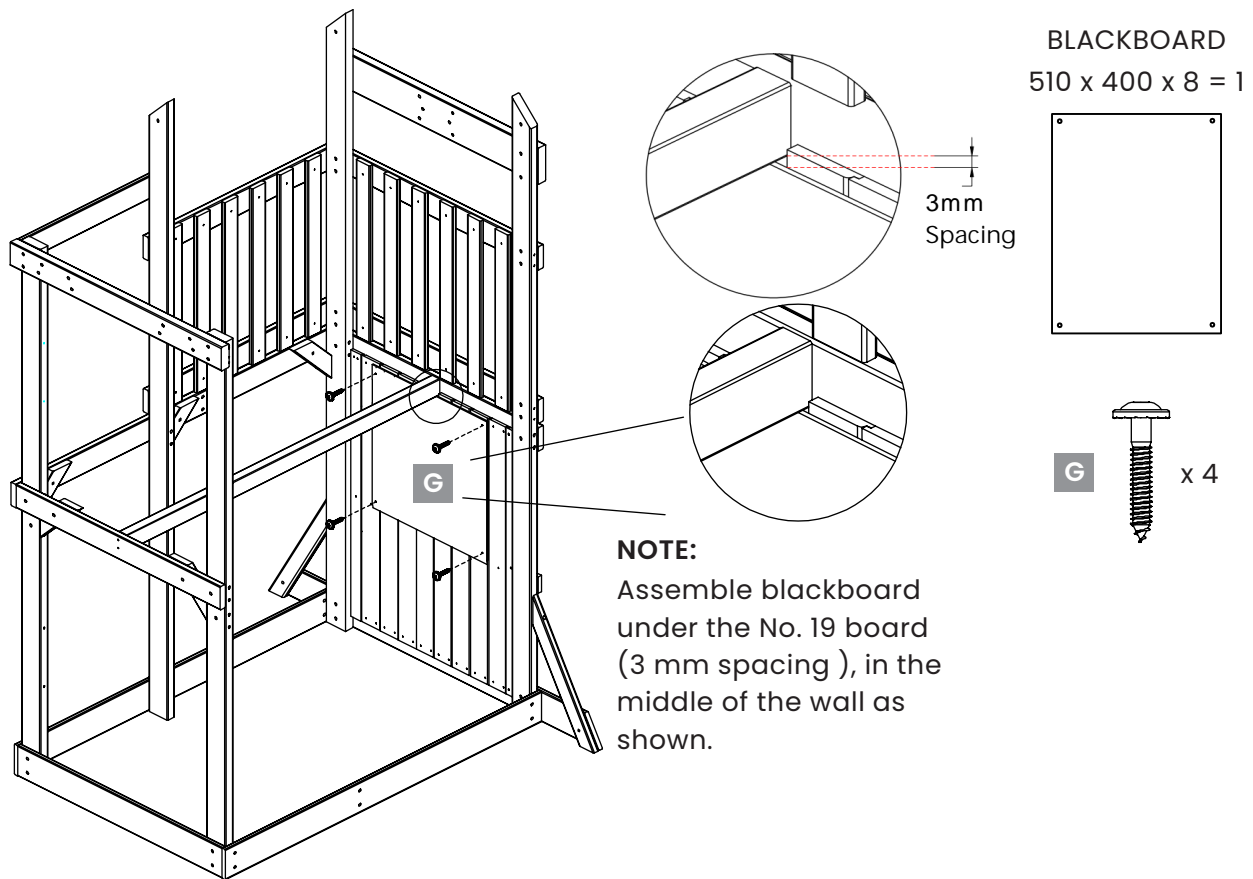
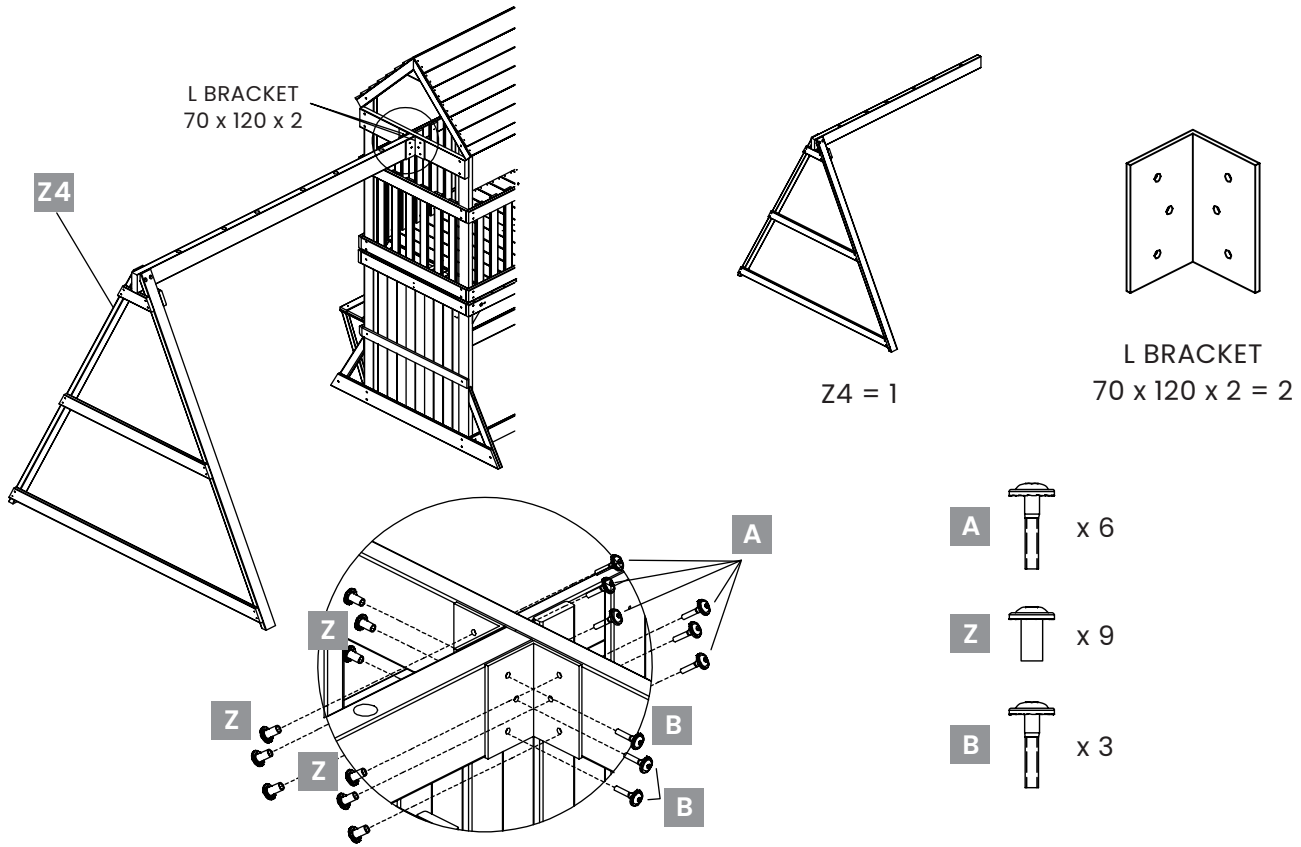

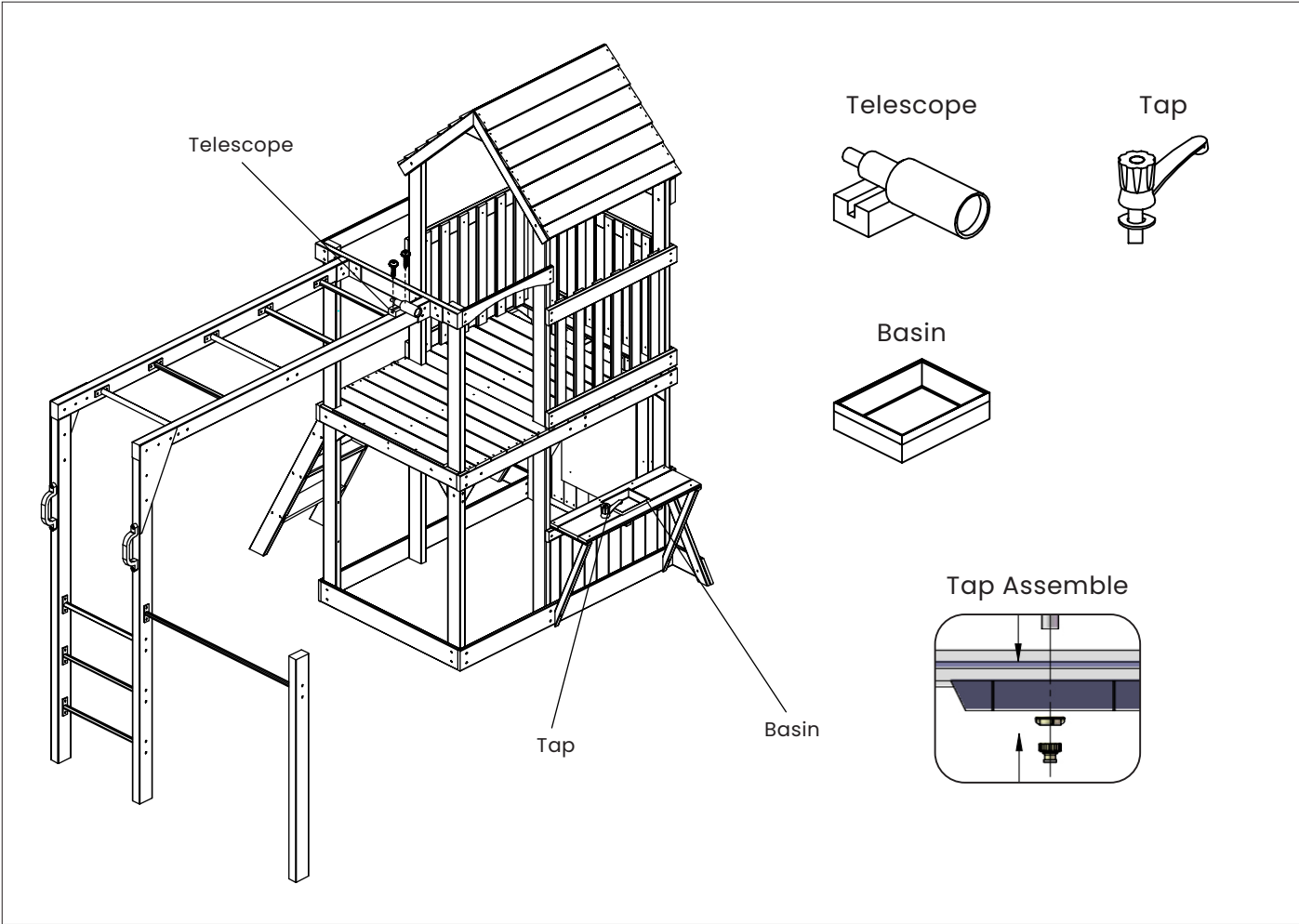
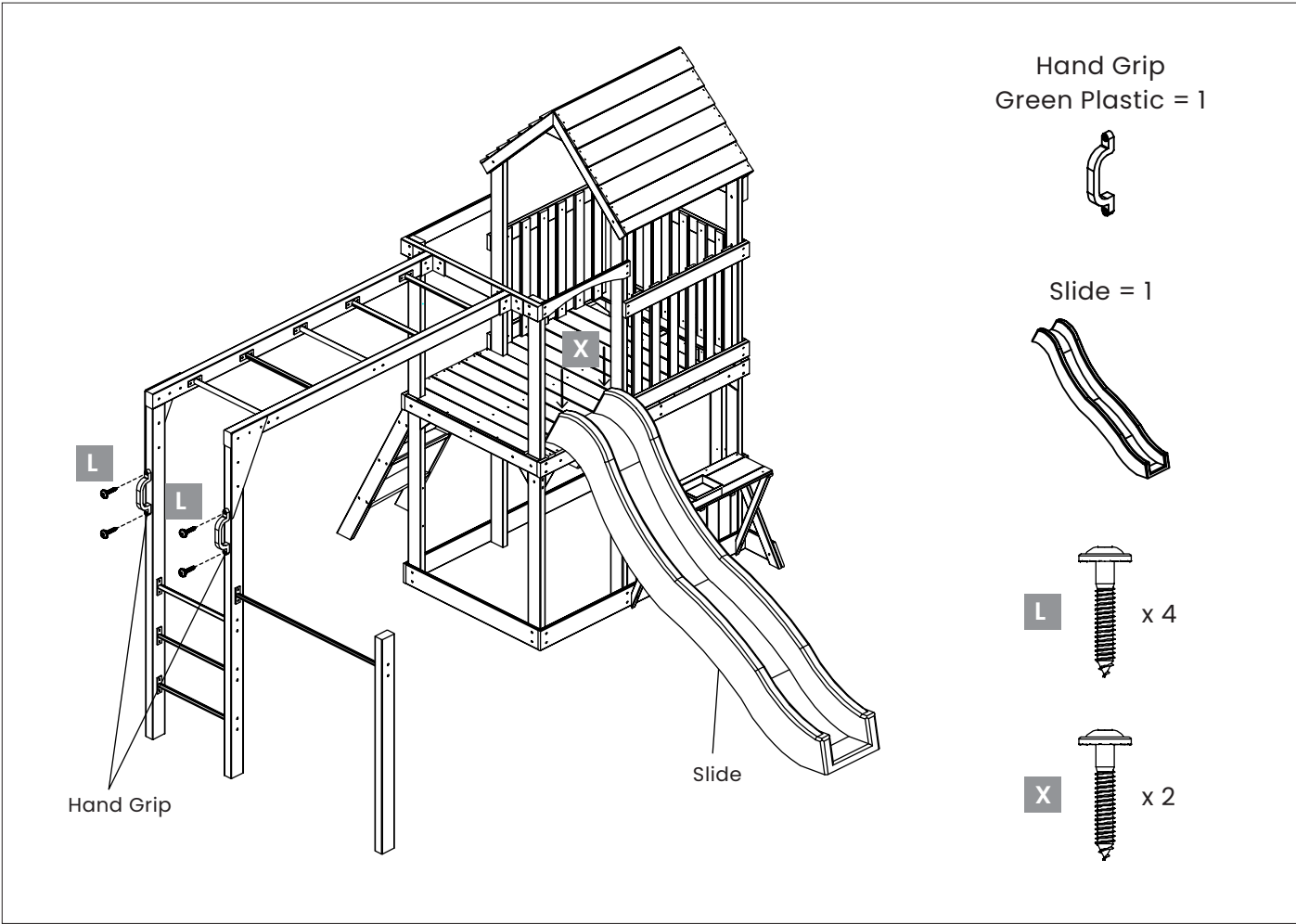

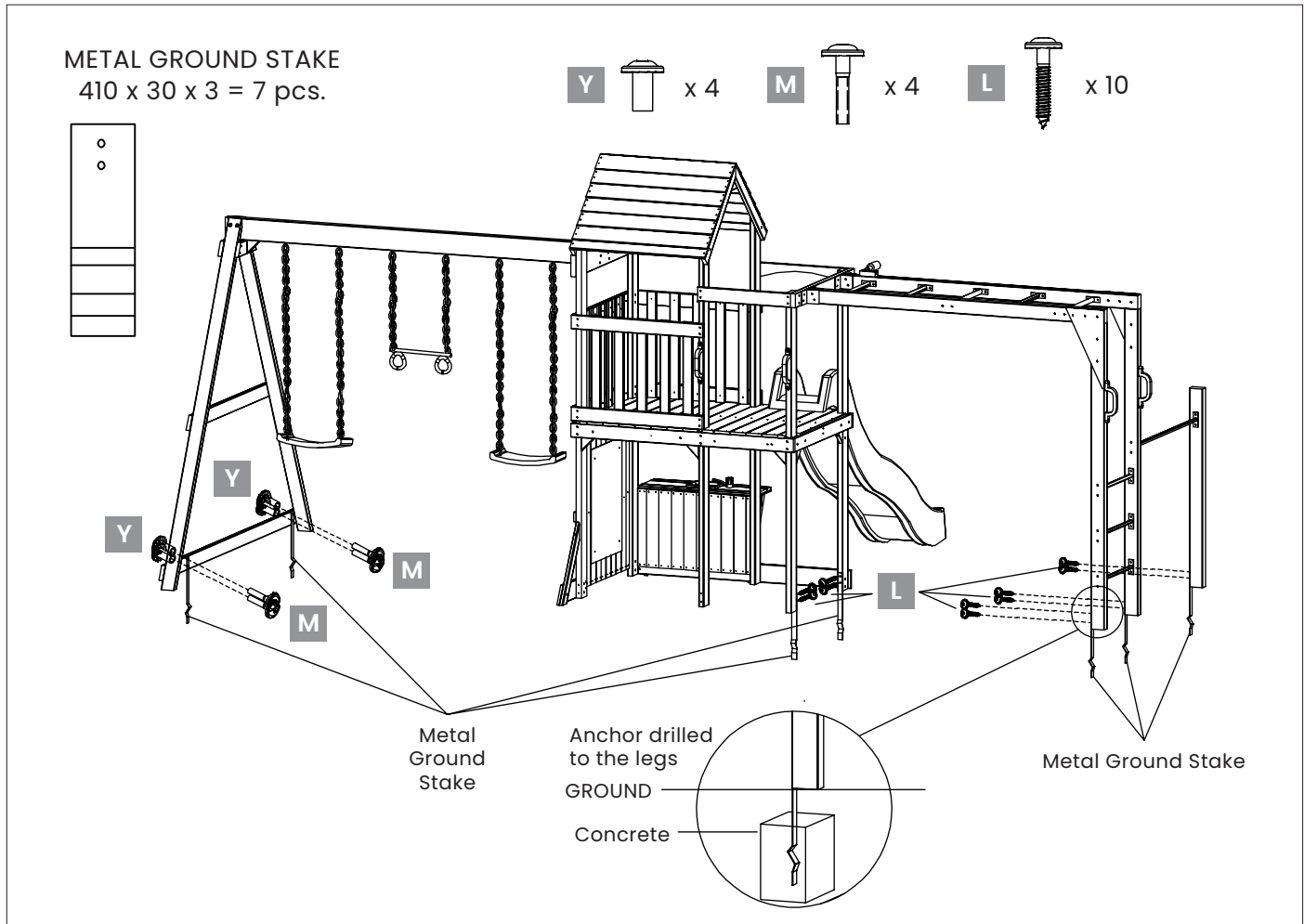
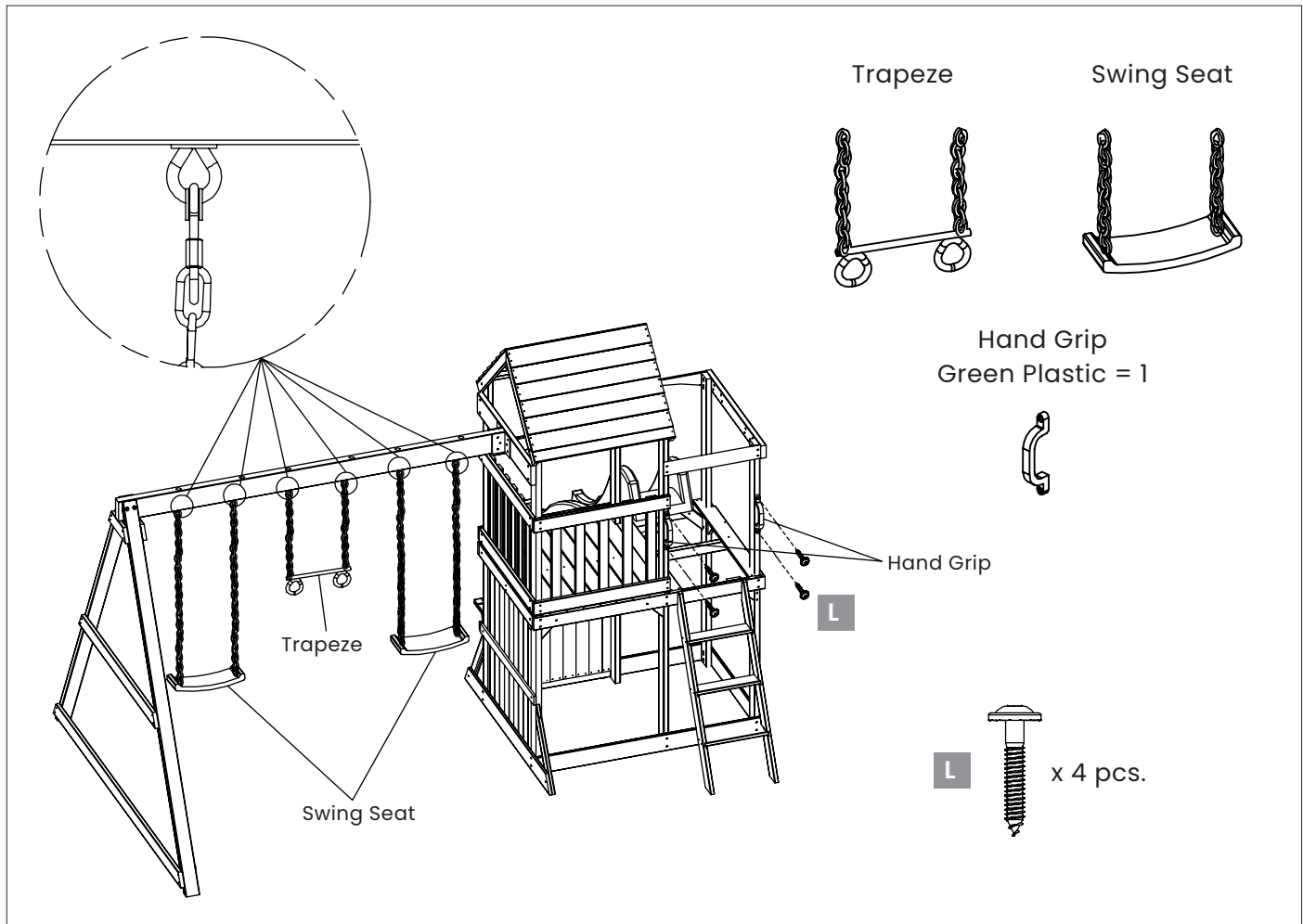

---

## IV. MAINTENANCE



**WARNING:** Please keep for future reference.

We recommend regular maintenance to be conducted at the beginning of each season as well as at regular intervals during the usage session for your play equipment to ensure all main parts/fixings are tightly secured, well-oiled and intact to avoid failure, injury or hazards.

### GENERAL ADVICE

It is of particular importance that this is followed at the beginning of each season as well as at regular intervals during the usage season.

- Check the accessories monthly as well as the play equipment's structure to prevent falling risks.
- Check and retighten screws, bolts, and all other hardware elements as necessary.
  - a. Do not over tighten to avoid damaging the thread or cracking the surrounding wood.
- Check all coverings and bolts for sharp edges and replace when required.
- Lubricate all moving metallic parts.
- When signs of oxidation and / or rust appear on various metallic parts of your equipment, sand rusted areas and tubular members and repaint using a non-lead-based paint when required.
- Where applicable: check swing seats, chains, ropes, and other means of attachment for evidence of deterioration.
- Replace when required in accordance with the owner's manual.

If your play structure is disassembled, be sure to clearly mark any attached metal plates to prevent accidents. Check all bolt covers and sharp edges and replace them if necessary.

For longer accessory life, we suggest storing them during the winter.

---

## V. PLAY SET ASSEMBLY MANUAL FAQs:

### 1. Does the area for the playset need to be level?

Yes, we recommend the playset be positioned on a flat level area for maximum safety and durability. The stakes provided should be used to secure it firmly to the ground.

### 2. What age range is appropriate for the playsets?

The playsets are recommended for children ages 3 – 10 years.

### 3. Is the wood treated with chemicals?

We use 100% Chinese Cedar wood which is naturally bug resistant, decay and rot resistant. To help ensure your child's safety, our wood is completely chemical free and we do not use pressure-treated wood. The stain we use is a top coat using a waterbased product that is for appearance only.

### 4. How often should the playset be stained?

We recommend the playset be stained once each year. A water or oil based stain can be used at the customer's discretion.

### 5. Why does it seem that my swing set is developing cracks?

Wood is a natural material; no two pieces are exactly alike. Each piece has its own characteristics and personality and reacts differently to climate changes. When any wood product is exposed to the elements, it develops "wood checks". A check is the radial separation of the wood fibers running with the grain of the wood. These are caused by the varying temperature and moisture conditions. A check is not a crack – it does not affect the strength or durability of the wood or structural integrity of the play set.

### 6. Do the playsets come with a warranty?

Yes. All Forest & Frolic products carry replacement warranty on all parts for manufacturer's defect. Please see warranty details for more information.

### 7. What is the best way to get started assembling the playset?

We recommend taking all the parts out of the boxes and arranging them by part number before you begin any assembly. This will not only allow faster assembly, but will also identify any parts that may be missing or damaged so they can be replaced before assembly.

### 8. The playset seems to rock or sway too much. What's wrong?

Rocking is caused by uneven ground or obstructions such as rocks, roots, etc. under the ground rails. These should be removed and the ground underneath re-leveled to prevent rocking. Also ensure the playset is securely staked to the ground using the anchors provided.

### 9. The 2"x4" boards do not measure 2"x 4". Why not?

It is common practice to describe lumber dimensions using the rough cut sizes from the sawmill and not the finished dimensions. Retailers, home stores, etc. all use this accepted practice for describing lumber dimensions. However, the playset is designed and constructed using the actual dimensions so everything fits properly and remains so during the life of the playset.

**10. The end beam is not straight up and down. Why not?**

This is normal. Forest & Frolic designs playsets this way to ensure the strongest structure possible. The slight angle adds strength and reduces rocking and twisting.

**11. The S-hooks for the swings won't close. What is wrong?**

We recommend placing them on a hard surface such as concrete (don't do this on anything that will dent such as metal or finished wood or glass which will break!). It will take quite a few strokes, but the hooks will close.



---

## VI. WOOD ADVICE

Our products are manufactured from premium timber. Great care is taken in selecting, machining, and treating the timber before it is sold to you.

1. Inspect wood parts monthly. The grain of the wood sometimes will lift in dry periods causing splinters to appear. Light sanding may be necessary to maintain a safe environment. Treating your Product with protection (sealant) after sanding will help prevent severe checking/splitting and other weather damage.
2. We have applied a waterborne translucent stain to your unit. This is done for colour only. Once or twice a year, depending on your climate conditions, you must apply some type of protection (sealant) to the wood of your unit. Prior to the application of sealant, lightly sand any "rough" spots on your set. Please note this is a requirement of your warranty.

Bear in mind that timber is a natural product and may experience changes throughout the course of its life. It may:

- Develop openings/checks (gaps, slits, apertures, cracks) along the line of the grain.
- Fade as the timber reacts with sunlight.

All woods are hygroscopic, that is, it will absorb or discharge moisture to attain equilibrium with the surrounding atmosphere. Timber openings/checks occur due to the moisture content between internal and outer surfaces of the timber. No two pieces of wood are exactly alike. Each piece has its own characteristics and personality and reacts differently to climate changes. When any wood products are exposed to the elements, it develops 'wood checks'. A check is the radial separation of the wood fibres running with the grain of the wood. These are caused by the varying temperature and moisture conditions. A check does not affect the strength or durability of the wood or structural integrity of the play set.

## WHEN SHOULD WOOD CRACKS BE A CONCERN?

Most of the wood splits will never become large enough to affect the reliability and strength of our products, however, there can be rare cases where splits can occur. This happens when a crack develops past the halfway point from the timber, splitting it into two separate pieces.

Feel free to contact us with detailed pictures of your product so we can assess and ensure that your playground remains safe.

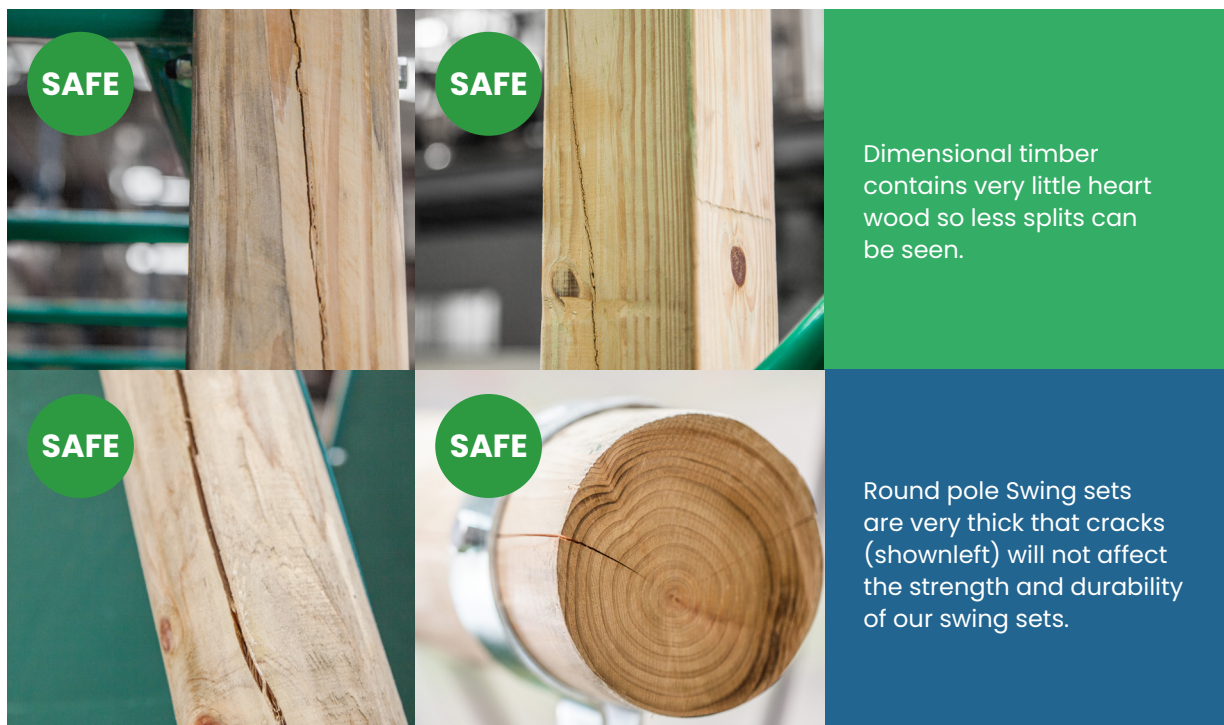

For more information: <https://forestandfrolic.co.nz/pages/natural-timber>

---

## VI. CLEANING

Do not use any abrasive cleansers for the cleaning. Use a soft, damp cloth to eliminate dirt and dust.

---

## VII. WARRANTY

### WARRANTY

#### NEW ZEALAND CONSUMER LAW

Most of our products come with a guarantee or warranty from the manufacturer. Please visit our website to view our full warranty terms and conditions:

<http://forestandfrolic.co.nz/pages/warranty-repairs>

In addition, we are committed to meeting our obligations under the New Zealand Consumer Guarantees Act. You are entitled to seek a repair, replacement, or refund if the goods are faulty, or the service is substandard. Full details of your consumer rights may be found at:

<http://www.consumerprotection.govt.nz>

Please send all warranty and support questions to the following email address:

[hello@forestandfrolic.co.nz](mailto:hello@forestandfrolic.co.nz)

forest  
+ frolic