



MECH K300

# User Manual

Tri-Mode Mechanical Keyboard  
Wired + 2.4G Wireless + Double Bluetooth

support@protoarc.com | www.protoarc.com

## Product Features

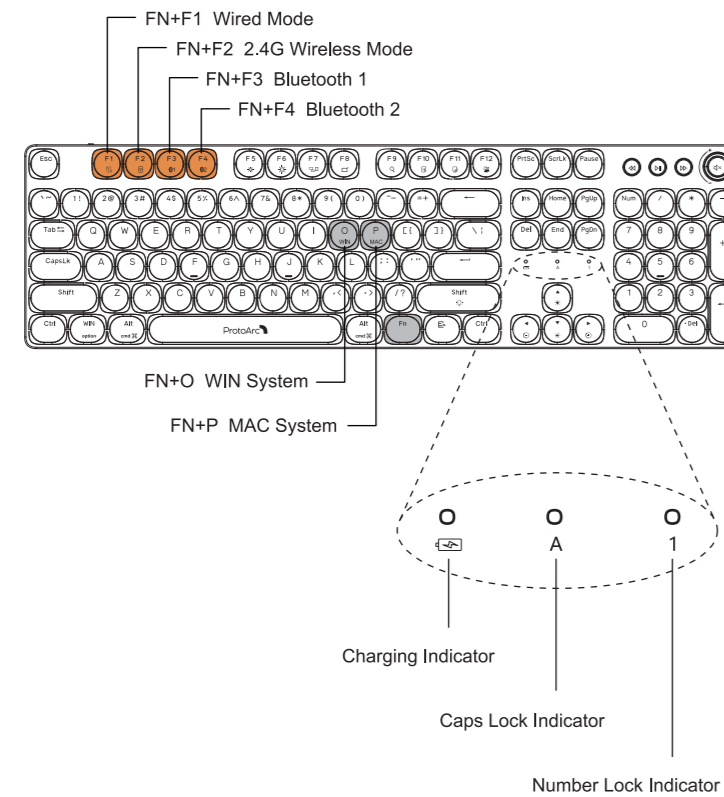

## Bluetooth Connection

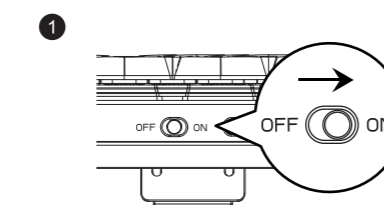

1. Turn on the power switch to ON.

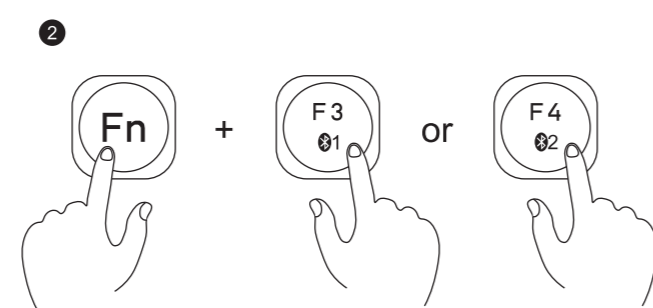

2. Bluetooth Connected: Short press FN + F3 or FN + F4 first to enter Bluetooth channel (F3 would slow flash to indicate that you are in Bluetooth channel), and then long press FN + F3 or FN + F4 for 3-5 seconds to enter bluetooth pair code mode, and at this time F3 or F4 would flash fast.

## Windows 10 System

3. Click "Bluetooth Device".

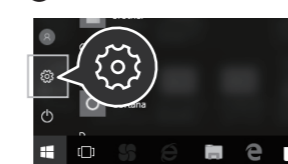

4. Click "Add or Remove Bluetooth Devices".

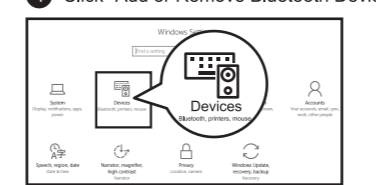

5. Your computer will automatically search for "MECH K300" and then click "Pair".

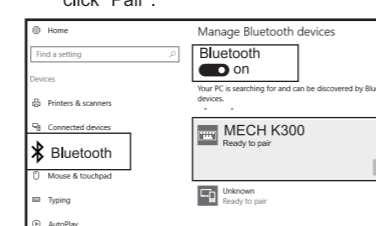

6. "MECH K300" is connected and can be used normally.



## Mac OS System

Please complete the Bluetooth mode installation step ①② before pairing.

3. Click "System Preferences" on Mac.



4. Click "Bluetooth" in "System Preferences".

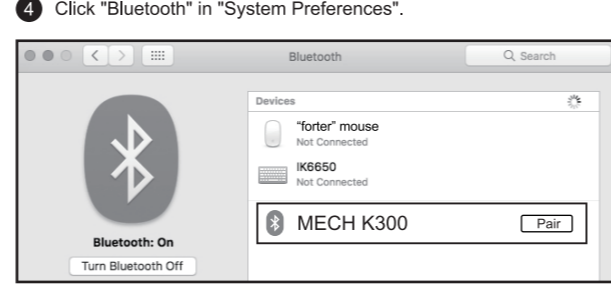

5. Your computer will automatically find "MECH K300", the click "Pair", and you can use it after installation.

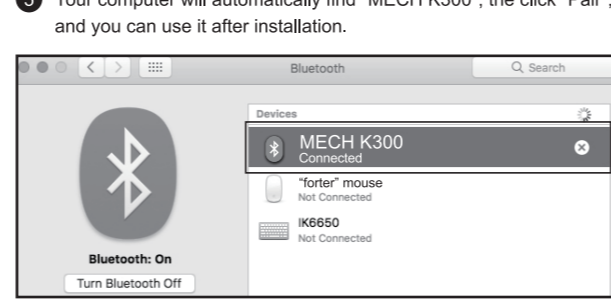

## Multi-functional Combination

Keys	WIN System	MAC System
FN+F5	Screen brightness down	Screen brightness down
FN+F6	Screen brightness up	Screen brightness up
FN+F7	Tiled activity window	Tiled activity window
FN+F8	Desktop display	Desktop display
FN+F9	Search	Search
FN+F10	Select All	Select All
FN+F11	Copy	Copy
FN+F12	Paste	Paste
FN+End	Clear Bluetooth pairing history	Clear Bluetooth pairing history
FN+WIN	Lock Win key and Driver	Lock Win key and Driver

Fn + Shift Backlighting mode switch (14 Adjustable lights)

1. Waterfall mode
2. Breathing mode
3. Constant bright mode(default)
4. String scanning mode
5. Flowing light mode
6. Floating light mode
7. Starry mode
8. Streamer mode
9. Rippling mode
10. Wave floating mode
11. One light moving mode
12. Shine wave mode
13. Dazzling mode
14. Raindrop mode

Fn + ↑ LED backlight brightness up

Fn + ↓ LED backlight brightness down

Fn + ← LED backlight speeds down

Fn + → LED backlight speeds up

## Driver Application

We provide a direct installation link online. Please enter our website (<https://www.protoarc.com>) to find the data package of this model (protoarc MECH K300), and then click to download (When downloading and opening, please make sure the keyboard is connected to the computer properly)

After downloading the driver, you can use the decompression tool to extract it. And then, please double-click the driver to run it.

### Driver Main Interface

Click Standard to select one key as the definition key, and then click to select Generalkey \ Modifierkey \ combokey \ multimedia \ powerkey \ macro \ Disable anyone you need to edit.

You can select to import the storage configuration, export the current configuration save, and restore the factory settings (More setting cannot be edited yet)

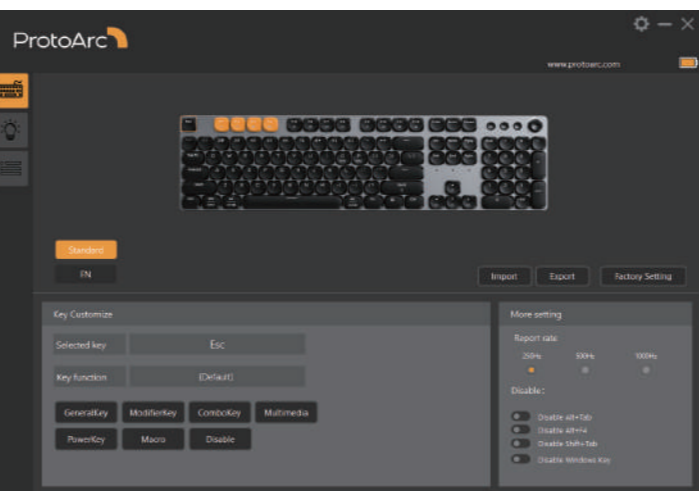

## Lighting-Effect Adjustment

14 Adjustable lights / Lights' timing / Speeds / Brightness

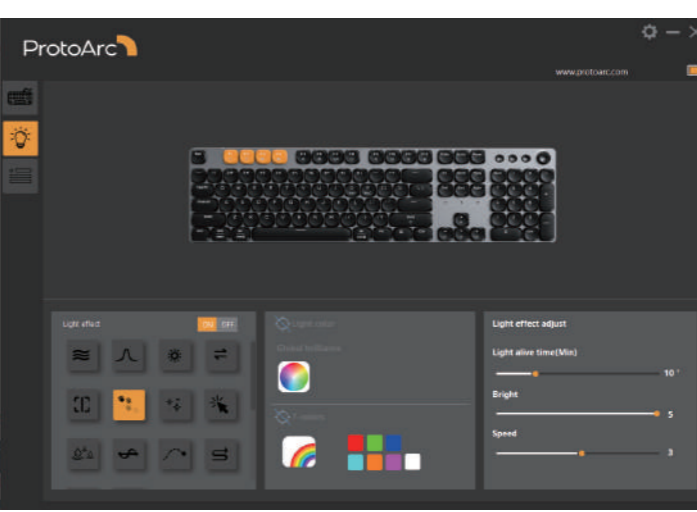

### Macro Definition Settings

Click on a blank macro command and enter the name you want, then click on Confirm, and then click on Start Recording, you can enter the function you want to define, click on Record Complete after you finish.

## Product Specifications

Support System	WIN7 / WIN8 / WIN10, MAC OS X 10.12 or above, Android 4.3 or above
Battery Capacity	1900mAh
Battery Life	1000 times charging cycles
Effective Range	6-10 meters

## Notice

1. When the keyboard is in low power, the indicator red light will slow flash (0.5HZ / 1 time), then the keyboard will automatically turn off the backlight and go into power-saving mode, which remind you to charge the keyboard immediately.
2. Charging indicator red light will always be on when charging, the red light will be off after full charge.
3. Backlight will automatically turn off after 10 minutes without any operation.
4. After entering sleep mode, please press any key to wake up the light again.
5. Long press FN + END key for 3 seconds, you can clear the Bluetooth pairing records, and at this time the keyboard backlight will flash continuously to indicate the success of clearing.