



# EK01 Plus

# User Manual

Dual Mode Ergonomic Keyboard  
with Backlit

[support@protoarc.com](mailto:support@protoarc.com)

[www.protoarc.com](http://www.protoarc.com)

## Product Features

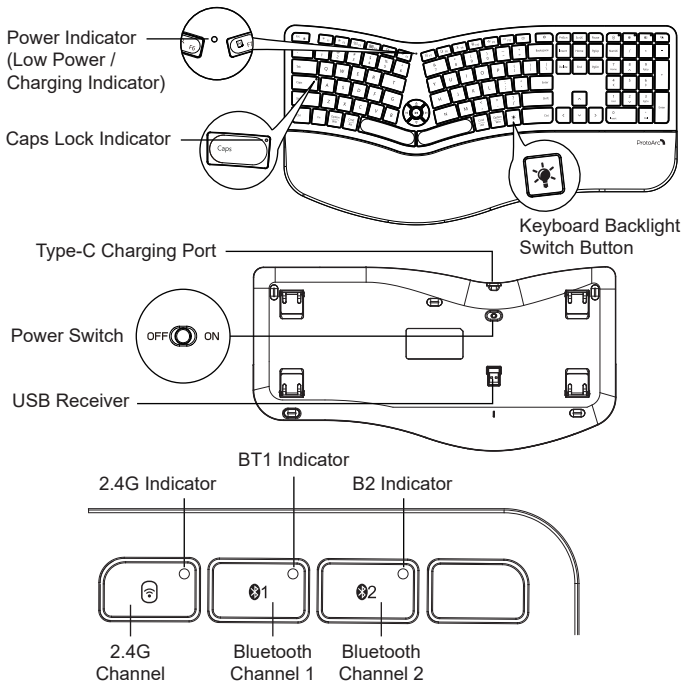

### Switch backlight brightness (Dimly, Medium brightness, Brightest)

The first press will turn on the backlight with a very dim brightness.

The second press will increase the brightness to a medium level.

The third press will set the backlight to the highest brightness.

The fourth press will turn off the backlight.

After 1 minute of inactivity, the backlight automatically turns off, and press any key to wake up.

After 60 minutes of inactivity, the backlight will automatically turn off, and the keyboard enters deep sleep mode. Press any key to wake up the keyboard, and the backlight needs to be turned on again.

## 2.4G USB Connection

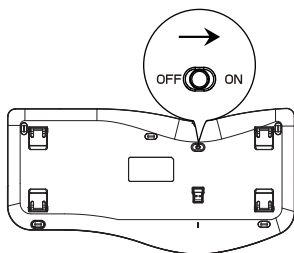

1. Turn the power switch to ON.

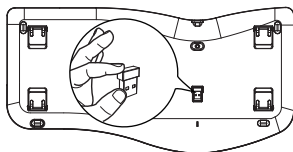

2. Take out the USB receiver.

1

2

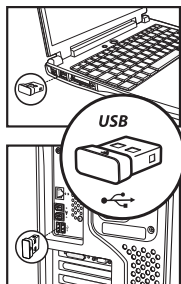

3. Plug it into a USB port on your computer.

3

4

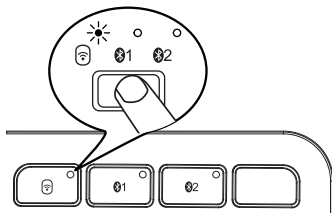

4. Press  key to switch to 2.4G channel, the white indicator will flash slowly, enter into 2.4G channel.

## Bluetooth Connection

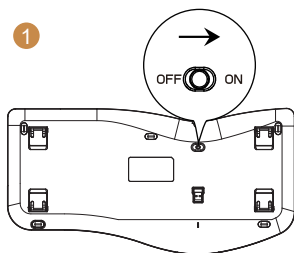

1. Turn the power switch to ON.

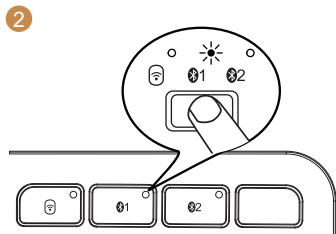

2. Single press **01** / **02** channel button, and the indicator light flashes once to enter the Bluetooth channel. Long press this Bluetooth channel button for 3–5 seconds again, the indicator light flashes quickly, then the keyboard enters into the Bluetooth pairing mode.

3

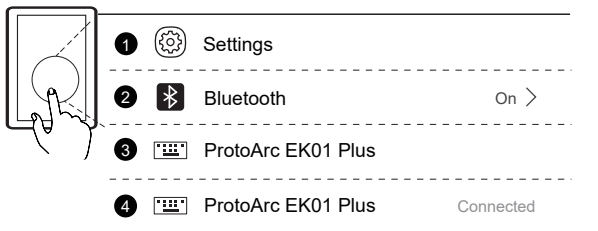

3. Turn on the Bluetooth settings on your device, search or select “ProtoArc EK01 Plus” and start Bluetooth pairing until the connection is completed.

## How to Switch Device Channels

After  |  |  are connected, press the corresponding channel key to switch between devices.

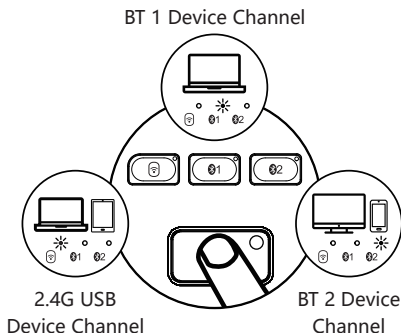

## Charging Guide

1. When low power, the backlight will automatically turn off first, and then the power indicator light will turn red and flash quickly.
2. Insert the Type-C port into the keyboard and the USB-A port into the computer to charge, the red light stays on while charging.
3. It takes 2-3 hours for one cycles full charged, and the indicator turns green when fully charged.

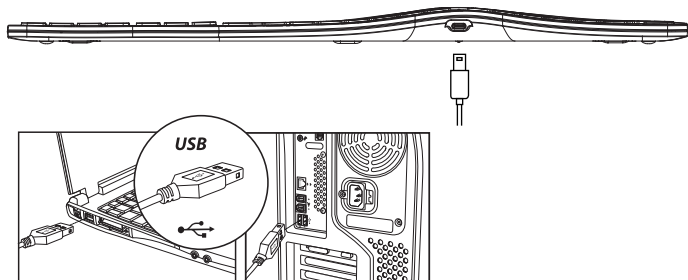

## Multimedia Function Button

Buttons	Windows	Android	iOS	MAC OS
	Decrease brightness	Decrease brightness	Decrease brightness	Decrease brightness
	Increase brightness	Increase brightness	Increase brightness	Increase brightness
	Window switching	Window switching	/	Multi-window preview
	Multi-window preview	/	App switching	App switching
	Show desktop	/	/	Show desktop
	Search	Search	Search	Search
	Select all	Select all	Select all	Select all
	Copy	Copy	Copy	Copy
	Cut	Cut	Cut	Cut
	Paste	Paste	Paste	Paste
	Mute	Mute	Mute	Mute
	Home	Home	Home	/
	Screenshot	Screenshot	Screenshot	Screenshot
	Open Setting	/	/	/
	Lock	/	Lock	Lock
	Volume up	Volume up	Volume up	Volume up
	Volume down	Volume down	Volume down	Volume down
	Previous	Previous	Previous	Previous
	Play&Stop	Play&Stop	Play&Stop	Play&Stop
	Next	Next	Next	Next
	Press FN+ESC to turn ON / OFF the FN function			

**Note:** The FN function is for alternate commands (F1-F12 & multimedia functions are dual-use keys).

## Product Specification

Project Name	Specifications
Applicable System	2.4G: Windows System Bluetooth: Windows 8, Windows 10 or above, Mac OS X 10.12 or above, Android 4.3 or above.
Battery Capacity	2000mAh
Battery Life	1000 charge and discharge cycles
Button Life	3 million keystrokes test
StandbyTime	≥ 365 Days
Awake Mode	Click any key to wake up
Effective Distance	8 m / 26 ft
Working Current	≤3mA
Size	480.1 x 244.4 x 25.6 mm / 18.9 x 9.6 x 1.0 in

## Sleep Mode

1. When the keyboard is idle for more than 60 minutes, it will automatically enter sleep mode and the indicator light will turn off.
2. To wake up the keyboard, simply press any key on the keyboard, and it will be ready within 3 seconds. The indicator light will light up again.

## Tips

1. If the Bluetooth connection is not working properly, turn off and turn on the keyboard again to restart the device's Bluetooth and attempt to reconnect. Or delete the extra Bluetooth option name in the Bluetooth connection list of the device and reconnect.
2. To switch to a successfully connected channel, press the channel button and wait for 3 seconds before continuing to use.
3. The keyboard has a memory function. When it connected on a specific channel, turn off the keyboard and turn on again, they will automatically connect to the default channel and this channel indicator is on.

## Packing List

- ▶ 1\* Wireless Bluetooth Keyboard
- ▶ 1\* USB Receiver
- ▶ 1\* Type-C Charging Cable
- ▶ 1\* User Manual