

boom ZINE

INDUSTRY NEWS | PRODUCT REVIEWS | SPECIAL OFFERS

THE NEXT BIG THING IS mini



HEAVY HITTER

blonde 2
brunette

THE RANGE YOU NEED

vertex
PICO

Page 27

AirBolt

Free Yourself





WWW.FKIRONS.COM



WRAPPING UP 2021

Power can come in all sizes, and this issue of the BAA Zine is ready to highlight the next big thing, in a small package. With the holidays around the corner, be ready for Microbeau's upcoming Xion Mini or check out Painful Pleasures' 2021 Holiday Gift Guide for ideas on how to treat that special tattoo artist in your life - even if it's yourself. Also, be sure to read about the BAA's philanthropic initiatives to help incredible organizations make a difference.

IN THIS ISSUE

BAA GIVES BACK - pg 3

TITANIUM FLUX - pg 5

SPECIAL EDITION COLORS - pg 5

INTRODUCING KILLSWITCH - pg 7

NEW SERVICE MUSKETEERS - pg 8

TATTOO SUBMISSIONS - pg 12

JAKE KARAMOL'S TOP PICKS - pg 14

PAINFUL PLEASURES' HOLIDAY GIFT GUIDE - pg 17

THE NEXT BIG THING IS MINI - pg 20

INTRODUCING AIRBOLT MINI - pg 21

MICROBEAU UNI - pg 23

EVENFLO MASTER SHOWCASE - pg 25

VERTIX PRESENTS PICO - pg 27

EVENFLO MASTERS REVIEW B2B - pg 28

It's So Black Even Light Has A Hard Time



Use code **blackout15** for 15% off
worldfamoustattooink.com

BOA Gives Back

Since 2020, the world has gone through a roller coaster of events, and its chaos has left Body Arts Alliance (BAA) - and its members - feeling philanthropic. Throughout 2021 the BAA took part in multiple charities, and we'd like to highlight some of these organizations so you can give back any way you can.

The first is **#CoverTheHate**, an extraordinary movement that started with Billy White, an artist in Ohio. Hoping to reduce hate within the world, White advertised free hateful tattoo cover-ups for anyone in another - no - better chapters of their lives and ultimately inspired his peers to do the same.



The next charity that we were happy to support is **Hope vs. Cancer**, a one-of-a-kind pediatric cancer foundation that aims to spread awareness, and most importantly, to lift children's spirits while undergoing treatment. Hope vs. Cancer manufactures temporary tattoos for kids battling, and each piece is designed and donated by tattoo artists across the globe. All donations are used towards advanced pediatric cancer research. www.hopevscancer.org

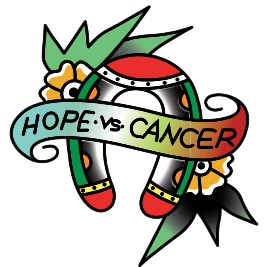

Miami Lotus House is another nonprofit the BAA has happily supported. A shelter dedicated to improving the lives of women and children who are experiencing homelessness. Providing sanctuary, support, education, tools, and more to empower and help them heal. www.lotushouse.org





The BAA also helped Mandy Sauler, a medical tattoo expert who's donating her time to help **Operation Smile**, in Egypt. Operation Smile is a nonprofit organization whose mission is to improve the lives of patients with cleft conditions. Sauler helps clients by implanting a small amount of pigment to the dermal layer of the skin around the lip line creating a lip shape. Sauler is always searching for artists that are willing to donate their time and services to organizations like this. www.operationssmile.org



The final - and most recent - contribution was during Breast Cancer Awareness Month to the **Living Beyond Breast Cancer (LBBC)** organization. For 30 years, Living Beyond Breast Cancer has worked to inform the world that there's more than one way to have breast cancer, and to provide trusted information, a supportive community and so much more for patients who are currently battling - or recovering - with Breast Cancer. www.lbcc.org

Recognizing the power you have to help others can really make a difference in this world. This holiday season, take a moment to give back. Any contribution can go a long way. philanthropy@bodyartalliance.com



FK Irons presents Flux Ti. The industry's first Titanium pen style machine.

The Rise of a Heavy Hitter

At 7.5 oz, the hefty mass resembles the lining and packing feel of traditional coil machines, but with zero pull back force. The weight is redirected right at the needle tip, making pigment saturation a breeze even with large needle configurations.

Built to Outlast You

It's high strength and corrosion resistance qualities makes Titanium the top choice for industries such as medical and military, and now FK Irons delivers these standards to the tattoo industry with the Flux Ti.

TITANIUM FLUX

NEW

Comfort Meets Mass

While the Flux Ti provides you with a hefty feel, it's geometric design - and balance - still provides comfortable maneuverability for those long, never ending sessions. Choose your power option, from traditional RCA cables - or cut the cord and go wireless with our PowerBolt or LightningBolt UNI wireless solutions.

**Sign up
for pre-order!**



COLORS

Along with the Titanium Flux, we're also dropping the Flux Shadow Camo and Spectrum, as well as the classic Xion in Aqua.

Flux in Shadow Camo (L)
& Spectrum (R)

Xion Aqua



RECOVERY
DERM SHIELD

The thinnest, most flexible matte film aftercare.



Enjoy a gentle application, maximum breathability, and protection from harsh elements.

The result? Your tattoos heal as smoothly and vibrantly as possible.



RECOVERYAFTERCARE.COM



KILLSWITCH™



92.2 mm

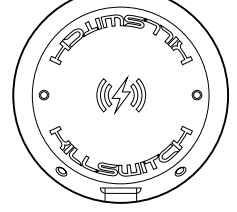

20.8 mm



Sign up for pre-order!

Designed with cross-contamination in mind!

What if you could toggle your device's power - during sessions - without the worry of cross-contamination? Introducing the **KillSwitch**, Darklab's first wireless footswitch with no moving parts, that keeps workspace cleanliness in mind & allows artists to turn their device ON or

OFF with just a simple tap. Compatible with Darklab's latest devices, it's designed to be user-friendly, & can be paired with the Darklab app for firmware updates via Bluetooth. It also has a built-in LED indicator to provide feedback when tapped & keeps track of the device's battery life.



On/off controlled with an accelerometer sensor- no mechanical components.



Darklab app connectivity via Bluetooth for firmware updates.



User friendly. Simply toggle your device's power with a tap of the device.



Reduces cross-contamination for maximum sanitation.



Compatible with Darklab's latest devices.



Non-slip surface base.

FK Irons' New Service Musketees

FK Irons strives to recruit hardworking employees who provide exceptional customer service, and we're aware that our service department needed some improvement. That's why we'd like to introduce FK Irons' new service musketeers.



First let's welcome **Ronald Wagner**, our Warranty and Service Supervisor, who's responsible for providing management, strategic and tactical planning for anything and everything that has to do with FK Irons' service. He's also the first to join our Technical Service Team, and since he started, he's made an immediate impact on the quality and speed of technical services. Utilizing the skills, he gained in the Marine Corps repairing electronic devices.

"At first, when I was the only person completing repairs, it was a challenge to keep up while simultaneously improving the workflow through the facility," said Wagner. "I was only able to maintain and keep the machine count backlog from growing. Once Abraham was brought on board, we were finally able to gain ground and decrease the amount of time it takes for repair completion."

The second on the welcome wagon is **Abraham Arguelles**, FK Irons' Service Associate, who works closely with Wagner and is responsible for servicing products. Since he started in August 2021, the two have been able to bring the backlog to zero machines and are proud to say they have a three-day turnaround for all repairs.

"At first I had no idea about FK Irons," said Arguelles, "but then Ronald told me about the job opening, knowing I would be a great fit since one of my favorite hobbies is to build remote control boats, submersibles, and cars. So, I applied, and I'm glad I did because I enjoy it."



The last of the repair trio is **Iraida Palacio**, another one of FK Irons' Service Associate. Palacio spent 4-years on the assembly team, and was added to the service team for her extensive knowledge and experience of FK Irons' machines.

"There's definitely been an improvement in quality because of her experience with the machines," said Wagner. "There was no extensive training necessary."



The three seem to work very well together, and have really made an improvement with our service turnaround time. In fact, Arguelles and Wagner, are brother-in-laws and have a bond that works well on the 'service field.'

Goes to show that teamwork really does make the dream work.

"This isn't the first time we work together," said Wagner. "We used to work together repairing commercial appliance equipment like ovens, toasters and fryers for large corporations like McDonald's, Miller's Ale House, and others. Once I saw they were looking to hire people for my team, I knew just the guy for the job."

Not only do they have an incredible bond, but they've also proudly served in the United States Military, and FK Irons is grateful for their service. We felt the only way we could resolve our service time was by hiring repairmen who kept their boots on the ground and were ready to take on the trenches of product service. Wagner served with the United States

Marine Corp. from 2017 to 2019, and he worked as a Ground Radio Repair Technician, which prepared him to do repairs on our products.

"Working as a radio repair technician has helped me directly with my duties here at FK Irons," said Wagner. "During my time in the Marines, I had to undergo 9 months of Basic Electronic Course and a 3-month Micro-Miniature Repair Course. This training directly translated over to servicing all of the electronic products that we currently produce."

His partner in 'service crime,' Arguelles, served active duty in the United States Army from 2013 to 2020, and he worked as a Light Airborne Infantryman and is now on reserves with the United States National Guard.

"My time in the military has certainly provided a foundation for my work ethic," said Arguelles.

We are happy and proud to have recruited such amazing employees who enjoy their work and are always ready to take on whatever repairs come their way.



PainfulPleasures

STOCKING YOUR SHOP FOR OVER 20 YEARS



PAINFUL **VIP CLUB** PLEASURES

Instant access. Instant updates.



Stay in the know with:

- Brand-new product announcements as soon as they hit our shelves
- Alerts on the hottest sales the second they drop
- Important updates, news, and content

SIGN UP NOW





@artbydrex

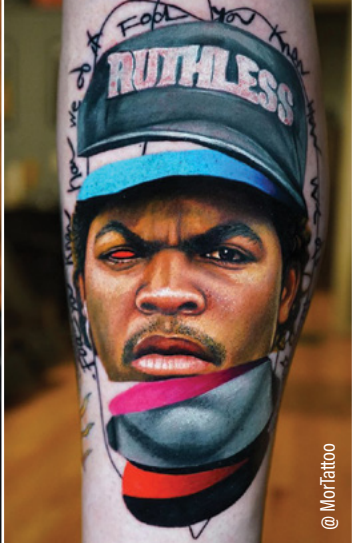

@MorTattoo



@dustindelongofficial



@EvanOlinTattoo



@tinas_ink_tattoo_gallery

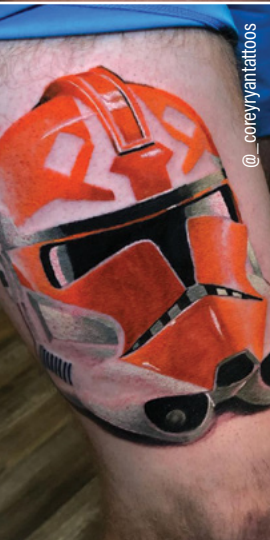

@_coreyvantattoos



@jamesboagtattoos



@dustindelongofficial



@esseSmithtattoos

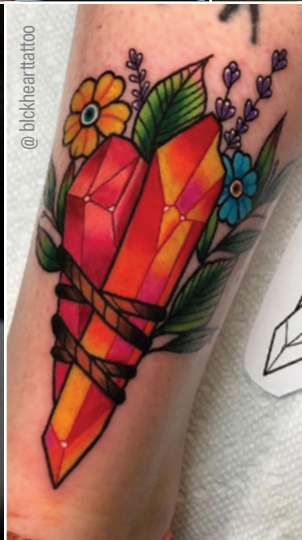

@blekheartattoo



@josepuidotattoo



@dustindelongofficial



@VLADOLLA

@vladolla



@vladolla



@josepuidotattoo

@JOSEPUIDOTATTOO



HIT US WITH YOUR BEST SHOT

Submit and if your image is chosen, it will print alongside the world's leading artists. Use #BAAZINEPIC



Tik Tok Star, 
Jake
 Karamol's
 Top 4 Picks

Jake Karamol is the #1 most followed tattooer on TikTok, with over 1.9 million subscribers. From his charisma to his signature sunglasses, Jake has the world's attention, and more than a few appointments in his books at Timeless Body Arts in Northeast, Maryland. He kicked off his TikTok career by posting funny skits based on client interactions and daily life as a tattoo artist. Since then, he began experimenting with all different types of content.

"I feel like you have to kind of ride this social media wave that's going on right now... TikTok as a platform is so new that when I got on the platform, there was only a handful of us tattooers on there and now we have thousands of different tattooers from all over the country making TikToks and expanding their business."

Based on his 10 years of experience, Jake aims to create educational (but still hilarious) content that helps the next generation of tattoo artists become more knowledgeable about the tattoo industry. He also gears some content toward body art collectors, and even future clients considering their first tattoos.

"Maybe some younger [people] that are going to be [tattoo] clients in the next couple of years might know how to be a better client because they have a good example. Or, maybe some younger generational tattooers might be a little bit more informed about how cutthroat this industry can be..."

When Jake isn't busy creating content for his TikTok, you can find him on YouTube and Instagram sharing his tattoo knowledge and giving his two cents on the latest tattoo supplies.

"With products coming out every month, ...it's hard to pick and decide what you want. So maybe they can skip a little bit of time by watching some of these videos and gaining a little bit more understanding of some of these products."

He's reviewed products from top-rated brands like World Famous, PEAK, A Pound of Flesh, FK Irons, Recovery, and Inkjecta. Jake also has his own go-to supplies. For him, the best products are those that hit the perfect "sweet spot." That means tattoo inks that aren't too thick or too watery and high-quality cartridge needles that don't wobble.

These are his current top 4 products for tattooing in any style.

FLUX AND EXO

"Lately, I've been using the Flux and the Exo by FK Irons, and I love the quality and consistency these machines produce, so... pretty much only use those now."

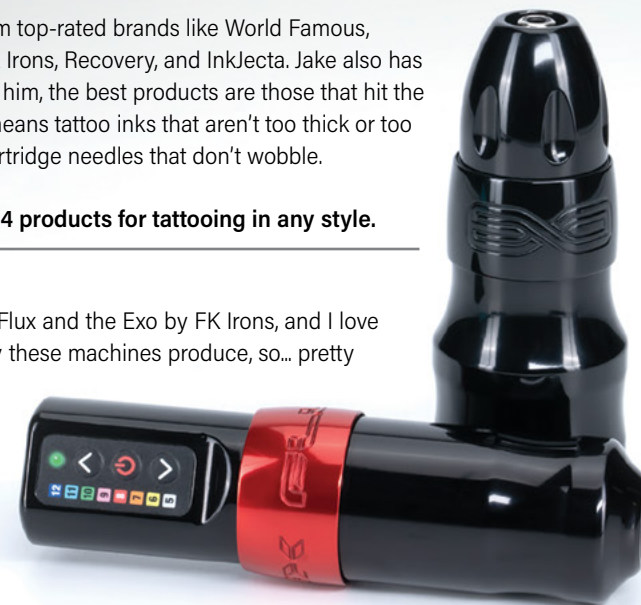

WORLD FAMOUS BLACKOUT

"I use Dynamic Triple Black, and it wasn't until I tried World Famous Blackout that I had found anything comparable. But now I'm using it regularly!"



PEAK NEEDLES

"I tried a lot of different carts before I found Peak, and a lot of them weren't consistent. When I use Peak, I know I'm getting a quality product every time."

Make sure to check out the PainfulPleasures YouTube channel for more reviews on the latest products, tips, and behind the scenes footage of Jake and other PainfulPleasures Pro-team artists. You can follow Jake's latest social media adventures on TikTok and Instagram at @jakekaramol.



THE KING RETURNS

NEW COLORS. NEW BOTTLE.
AND A NEW WAY TO BUY DIRECTLY
FROM THE SOURCE.
KUROSUMI.COM

KURO SUMI 

Use Code kurosumi15 for 15% off Sitewide

KUROSUMI.COM

THE HOLIDAYS ARE RIGHT AROUND THE CORNER. NOT SURE WHAT TO ADD TO YOUR WISH LIST YET?



Take a sneak peek at our 2021 Painful Pleasures Holiday Gift Guide

Darklab's LightningBolt UNI

Darklab's LightningBolt UNI battery pack is a top-drawer must-have. Compatible with all major RCA tattoo machine brands, this battery pack lets you easily crush any 10-hour tattoo with a single charge.



Recovery Derm Shield

Don't overlook this stocking stuffer. Give your work the protection it deserves with Recovery Derm Shield, the most flexible, breathable aftercare bandage on the market.



World Famous Inks Yarson's Dark Set

This is the ideal gift for any black and grey realism artist in your life (even if that artist is you).

Enhance contrast and reach a new level of boldness with the Yarson's Dark set.



Darklab's Hover Power Supply

Add convenience to your gift list with the Hover Power Supply. Take advantage of its touchless interface, which lets you easily turn the power supply on and off. Plus, make simple voltage adjustments with just a wave of your hand.



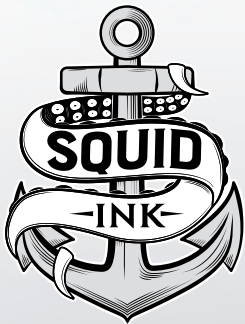

Our office doesn't suck

Two iconic brands, World Famous Tattoo Ink and Virgin Voyages, have partnered to create the first tattoo studio on the open seas.



Join the crew to join the party
www.squid.ink



A Pound of Flesh Kewpie Doll

The world's most famous Kewpie Doll can now be found in your shop. Practice your tattooing on the most traditional toy yet. Measuring at 11 inches tall. This pound of cute, tattooable, synthetic flesh is one of our most unique products, and it's here to be your practicing best friend.

Peak Triton

Peak Triton Cartridge allows artists to achieve crisp, bold lines and pack color with virtually no mess. Using a plunger ball to keep needles steady, and provide unparalleled control and precision. Experience ultimate control when working with large magnums, and rely on Triton cartridges' full safety membrane to prevent any ink backflow during sessions.

Peak Triton cartridge needles are available in a wide variety of configurations.



Recovery Saline Spray

Recovery Saline Spray provides a natural solution to keep new - or irritated - piercings rinsed and fresh. This vegan-friendly, sterilized saline spray is environmentally friendly and has no CFCs, drugs, preservatives, or additives. Promoting healing and maintaining the well-being of new piercings by removing dirt and debris. Recovery Saline Spray is the solution to gentle, but yet cooling, effect to soothe the skin.

For more gift ideas, or items for your wish list, visit our whole 2021 Holiday Gift Guide at painfulpleasures.com today.





XION mini

Our Biggest Announcement, but in a Small Package

Whether you're at the top of your career - or starting your PMU journey - the Xion Mini is the machine designed for everyone. With a 2.5 mm stroke it's ready to take on all skin types - right out of the box. The Xion Mini is lightweight at only 3.1 ounces, and is built with a Darklab, designed, proprietary motor, which provides consistent power with virtually no vibration.

Hands Down, Comfortable

The Xion Mini's compact design and its center of mass provides optimal balance, ultimately reducing artists' hand fatigue.

Power Couple

Powered by RCA connectivity, or pair it with any of our wireless solutions. Whether it be the LightningBolt UNI, Hover or Airbolt Mini, experience a whole new sense of freedom.

Give It A Try

eGive adjustment through our battery pack wireless solutions, and activate Siri voice control through the Darklab app via Bluetooth.

Meeting Standards

Compatible with standard membrane cartridges. Easy set-up and wrapping.

How mini can a Mini really be?

How about shorter than two cartridges! At less than 92mm tall, the Xion Mini is the most compact PMU device available.

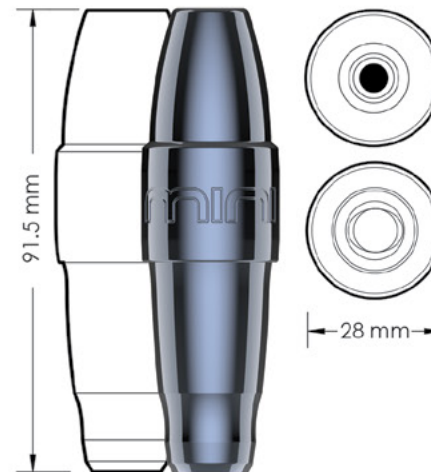

The Xion Mini will be available in Bubblegum and Gunmetal at launch.

**Sign up
for pre-order,
and be the
first to go mini!**



Pair and power the Xion Mini with the Airbolt mini and create Microbeau's harmonious mini power couple.



AIRBOLT mini

The Airbolt Mini was engineered to deliver wireless power in a super compact package.

- Weighs: 2.8 oz (79 g)
- 55.6 mm x 48 mm x 24 mm
- Up to 10 hours of battery.
- Built-in anti-slip magnetic pad. For extra support, several wearable and mounting accessories will be coming soon.
- Easy to bag/barrier protect.
- eGive capabilities on the Darklab app via Bluetooth.
- The only power supply on the market with the capabilities to connect to any machine, with your choice of cables or connectors.

Hey you, it's me.

New look, same trusted formula.



PERMA BLEND.

beauty that won't wash away

permablend.com

MICROBEAU'S

LightningBolt

NEW PRODUCTS

Microbeau strives to deliver innovative products to the PMU industry that allows artists to focus on enhancing their client's natural beauty. That's why we engineered a powerful battery that's not only sleek, but can be universally connected to any RCA machine in the current PMU market-making your machine wireless.

The LightningBolt UNI has finally arrived, and it's ready to give power for all your PMU needs.



The LightningBolt UNI is a reliable, wireless battery that provides a whole new sense of freedom. This revolutionary power supply was designed to exceed standard safety regulations, and maintain the machine's Ergonomic Balance Point. Its compact design allows the battery's weight - at only 2 oz - to remain as close to the machine's center point as possible, allowing PMU artists to retain the original balance and keep control during any procedure.

Register for pre-order, and get yours first!



FLUX S

vertex
PICO



microbeau
WWW.MICROBEAU.COM

evenflo colours MASTER Showcase



Verica Blaško | @vericablaskopmu

The first to welcome to the Evenflo Colours Master Artists is Serbia's PMU queen Verica Blaško. During her 15 years in PMU, Blaško has mastered Powder Brows and 'Aquarelle' Lips and was the first to apply these

techniques within her country. She has built her reputation as an artist whose students become masters, and her clients leave her salon, Eternal Beauty, happy and confident with her work.



Quynh Ly | @browsby.q

Our next on the welcome train is Quynh Ly, and she specializes, and teaches, Microblading, Combo Brows, Ombre Brows, Permanent Eyeliner, Color Correction, and finally Removal. Since 2017, Ly has taken a variety of classes and spent her time and

money to educate and perfect her technique. She runs her studio, Gem Beauti Studio and Academy, and is 11x certified within the cosmetic tattoo industry, and has performed over 2,000 successful procedures.



@jessicabrunspm



@katdoescolor



@scalpmicro_usa



@browserie



@vericablastopmu



@evgeniya_shevela

VERTIX PICO

NEW PRODUCT

The PMU Cartridge reimagined. Introducing the Vertex Pico, a PMU Cartridge like no other.

Featuring a slimmer, tapered design, the Vertex Pico allows you to come in closer proximity with your procedures providing you with the 'pencil style' grip all artists know and love. We understand the importance of stability in performance, that's why we've redesigned our tips from the ground up. Now sturdier and slimmer, providing stellar performance, with effortless pigment implantation.

For the first time we introduce Slope Configurations, as well as the thinnest needles we've ever created. At just 0.15 mm in diameter, the 1RL is the smallest needle configuration on the market.

Create effortless results and enjoy PMU like never before.



Subscribe to Pico Needle news!



Slope Configuration
5 sloped .25 mm, long taper



HIT US WITH YOUR BEST SHOT

Submit and if your image is chosen, it will print alongside the world's leading artists. Use #BAAZINEPIC

Evenflo Colours Masters & blonde 2 brunette



Relying on science and top artists' testing, blonde 2 brunette is our new properly modified brow pigment set with a hybrid formula that works on all skin types on the Fitzpatrick scale and can be used mixed or straight out of the bottle.

Since the release of our new brow pigment set, we've started to receive incredible feedback from Evenflo Colours' Master artists on how they like to use these beautiful tones and achieve natural-looking results.

Our first Evenflo Colours Master, Anna Ocko, loves to mix our new brow pigment set with Evenflo Colours' initial organic brow set and has noticed her brows heal with true color retention.

"First pass should be done with the organic set and 1RL needle," said Ocko, "the second pass is performed with the Hybrid set and bunch shader 5-7-9 pin needle. This helps result in true color retention and gives me an opportunity to do more beautiful work within touch-up sessions."

Evenflo Colours Bolivian Master artist, Christine Javornik, uses blonde 2 brunette and finds it works "beautifully."

"The retention is higher," she said, "and the consistency runs so smoothly with needles. Fewer passes were needed and it still sets super quick? I love it!"

Our last Evenflo Colours' Master Artist, Ekaterina Dvoeriadkina, has found that our new brow pigment can be used straight out of the bottle.

"What I love are the healed results," said Dvoeriadkina. "It's always beautiful and absolutely natural, which is important for my clients. Clean, non-mixed, shades are the most beautiful."

Get your blonde 2 brunette brow pigment set now and start achieving natural results that you and your clients will love.



Be sure to tag us on Instagram using our pigments, and enter for a chance to be featured on our page. Use **#evenflo colours**



PEAK

ELARA

PERMANENT MAKEUP MACHINE

EXPERTLY CRAFTED
LIGHT-WEIGHT
LOW VIBRATION

REDEFINE BEAUTY

No more hand fatigue, wrist pain, or multiple machines for multiple procedures. Elara is super-light-weight, ergonomic, and universally compatible with all PMU needles on the market.

 [PEAKNEEDLES.COM](https://www.peakneedles.com)

 [PEAKNEEDLES](https://www.instagram.com/peakneedles)



NOW AVAILABLE

PEAK

TRITON

CARTRIDGE NEEDLES

TATTOO WITH
UNMATCHED
CONTROL



REINFORCED WITH US-PATENTED
LINEAR TECHNOLOGY

Triton cartridges keep your needles on track with their one-of-a-kind plunger ball stabilizer. The stabilizer lets you pull crisp lines with ease and pack in color – even with the biggest magnums.



PEAKNEEDLES.COM
@PEAKNEEDLES

