



MAXVAC

DV80-MBN



**INSTRUCTION
MANUAL**

**GEBRAUCHS-UND
WARTUNGSANLEITUNGEN**

INSTRUCTIEHANDLEIDING

**ISTRUZIONI PER L'USO
E LA MANUTENZIONE**

**INSTRUCTIONS D'UTILISATION
ET D'ENTRETIEN**

**INSTRUCCIONES DE USO
Y MANTENIMIENTO**

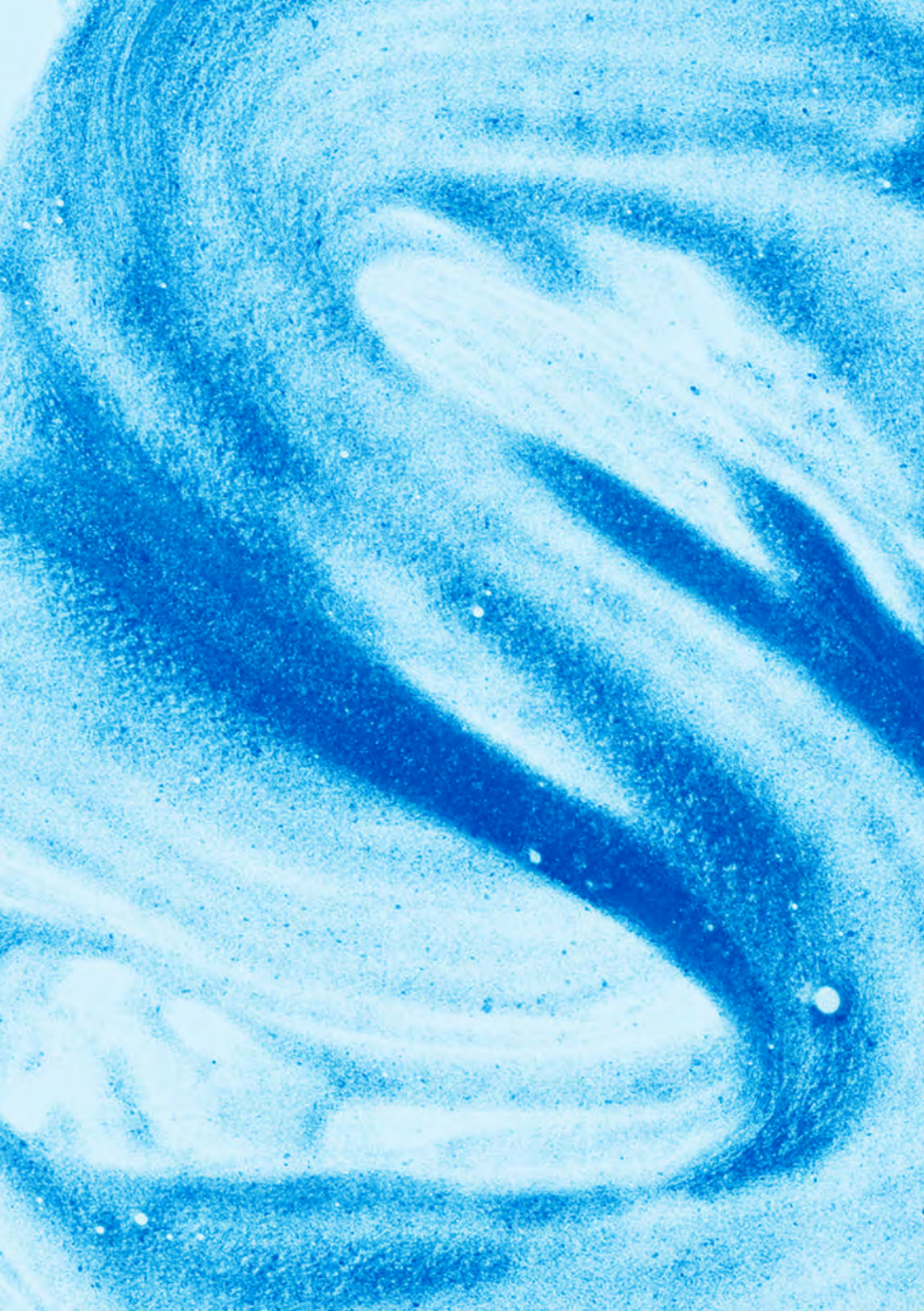



DV80 MBN

ENGLISH	4
---------	---

DEUTSCH	26
---------	----

NEDERLAND	48
-----------	----

FRANCAIS	70
----------	----

ITALIANO	92
----------	----

ESPANOL	114
---------	-----



ENGLISH

INSTRUCTION MANUAL

WARNINGS	4
DESCRIPTION SYMBOLS INSTRUCTIONS	9
KEY TO SYMBOLS	9
TECHNICAL SPECIFICATIONS	10
ACCESSORIES	11
OPERATION	13
FILTER SYSTEMS	15
PROPER USE	19
MAINTENANCE	20
TROUBLESHOOTING	23
EU DECLARATION OF CONFORMITY	24

WARNINGS



The appliances described in this manual are suitable for:

- Vacuuming dust and liquids.
- Professional use (e.g. hotels, schools, hospitals, factories, shops, offices and rental agencies).
- The 'M' Category is suitable for the separation of dry powders (as long as they are not explosive, inflammable and/or carcinogenic) with maximum permeability $<0.1\%$ and MAC (Maximum Allowable Concentration) $\geq 0.1\text{mg/m}^3$

Carefully keep this instruction manual.

- An electric appliance is not a toy. Use and store it out of reach of children. Children must be supervised to ensure they do not play with the appliance.
- Keep the packaging components (cardboard box, PSE protections, etc.) out of reach of children.
- This appliance has not been designed to be used by person's (including children) with reduced physical, sensory and mental faculties, or who have not first read this instruction manual.
- This appliance has been designed to operate with alternating current only. Before starting the appliance, check that the mains voltage corresponds to that indicated on the data plate.



-
- Check that the electric system is fitted with a differential switch (type automatic cut-out)
 - Use an extension cable only if in perfect conditions and make sure that the cross-section is appropriate for the power of the appliance plus the power of the electric tool.
 - Never leave the appliance running unattended.
 - If the discharge air is released back into the working environment, it must have a sufficient Class 'M' air exchange index. In order to observe the required limit values, the flow rate must be maximum 50% of the fresh air flow rate (volume of the environment VR by air exchange index LW). Also comply with the regulations in force.
 - Completely unwind the power cable before starting the appliance.
 - Do not aim the suction hose at ears, eyes, hair, persons or animals in general.
 - During transport of the appliance, the motor must be off. Also ensure that the appliance cannot disperse dust into the environment and that it is in a stable position
 - Shut off the machine in the case of high dust emission, fire or smoke. Using the appliance is allowed only after it is checked and repaired by an authorized person.
 - Always pull the plug from the mains power socket immediately after use and before carrying out any cleaning or maintenance on the appliance.

Risk of falling:

Do not climb onto or sit on the cover of the appliance.



WARNINGS

- Repairs may only be carried out by specialists who keep the original spare parts supplied by the manufacturer.

Repairing the appliance yourself can be extremely dangerous.

- In compliance with the regulations in force, appliances that are to be discarded must be made unusable by cutting the power cable before disposal.
- The appliance should be decontaminated by vacuum cleaning methods and wiped clean or treated with sealant before being taken out of a hazardous area. All the other appliance parts shall be regarded as contaminated when removed from hazardous area and appropriate action taken to prevent dust dispersal.
- During cleaning and maintenance, it is recommended to always wear personal protection devices (gloves and mask) as required by the national regulations in force.
- Before proceeding with maintenance operations, it is strongly recommended to first decontaminate the appliance by vacuuming clean air for a few minutes and to clean it on the outside.

Never use the appliance:

- When your hands are wet or moist;
- If it has fallen and shows evident damage or malfunctions;
- If the power cable or plug is defective.

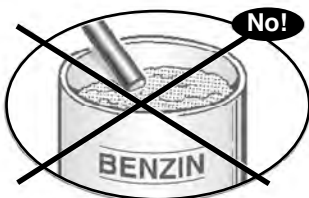

**Clean the appliance using water only.
Do not use trichloroethylene, solvents
or abrasive detergents.**



- Maintenance and cleaning must be carried out in a room with adequate ventilation and in such a way as not to endanger the operators or other persons.
- Clean the place where maintenance is carried out in order to prevent that hazardous substances are dispersed into the environment.
- During maintenance, repair and disposal operations, all the contaminated parts of the appliance that cannot be completely cleaned must be eliminated; put them in impermeable bags according to the national regulations in force for disposal of special waste.
- For proper disposal, it is advisable to indicate on the impermeable bag which substances have been vacuumed.
- It is recommended to carry out a technical inspection on the appliance at least once a year to check that the seals are tight and proper functioning of the control mechanisms so that any malfunctions can be detected. Daily check the integrity of the filter system.
- This appliance has been designed to be used by adequately trained persons, specifically on cleaning and maintenance of the appliance, the risks deriving from vacuumed materials and their proper disposal, and replacement of spare parts according to the directives in force in the various countries.
- Do not vacuum flammable, potentially explosive or corrosive substances and incandescent ash. These substances may compromise safety and operation of the appliance.
- Never put the power cable on sharp edges, do not crush it and keep it away from the rotary electric brushes
- Only use the socket outlet (when fitted) on the machine for purposes specified in the instructions.
- In the event of leaks (foam or liquid) immediately turn off the appliance.



If the power cable is damaged, it must be replaced by the manufacturer or approved technical service centre or in any case by a person with similar qualification so as to prevent any risk.

CAUTION

- This machine shall be stored indoors only.
- Frequently clean the seat where the safety float slides and periodically inspect it to check its integrity.
- Do not use the appliance when the filter system is damaged.
- Dust class 'M' does not apply when vacuuming liquids.

REMEMBER THAT

- In case of potentially hazardous substances come in contact with eyes or skin, rinse with water and consult a specialist center.
- In case of potentially hazardous substances were inhaled or ingested call a physician. Do not induce vomiting to avoid contaminating the lungs; it is recommended to rinse your mouth without swallowing water.
- If, in the case of spontaneous vomiting, is supposed to have entered the lungs of potentially dangerous substances, transport to hospital.

The manufacturer declines all responsibility for improper use or not according to the instructions provided, tampering with and inadequate maintenance of the appliance.



SYMBOLS

DESCRIPTION SYMBOLS INSTRUCTIONS



Read
the instructions
before using the
appliance.



Attention
indicates
a potential
hazardous
situation.



Note
warning for
proper use



**Operator
Manual**
Instructions for
use

KEY TO SYMBOLS



Socket for
electric tools



Connection for
pneumatic tools



Wet & dry
vacuum cleaner



"Self-cleaning
filter" function



Professional



Blower
connection



Industrial



TECHNICAL SPECIFICATIONS

DV80

Power supply voltage	120 V~ 230 V~
Frequency	50/60 Hz
Power Rating	120V = 2400 W 230V = 2400 W
Maximum airflow approx	110 L/sec
Drum made of	
Rated drum capacity	80
MAX suction approx	24 kPa
Motor insulation class	
Appliance insulation class	I ^a
Motor type	High efficiency bypass
Approximate appliance dimensions	540 x 710 x 950 mm
Packaging size approx	620 x 660 x 8850 mm
Packed appliance weight approx	31 Kg
Appliance weight *	25.2 Kg
Constant and weighted sound pressure level	< 69 dB(A)

* Weight in accordance with the procedure EPTA 01/2003

ACCESSORIES

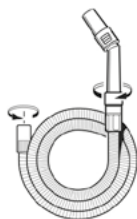

DV-ACC-506

ø45 mm flexible
hose with
ergonomic
grip and
downflow device



DV-ACC-115

Plastic extension
wands



DV-ACC-104

Crevice tool

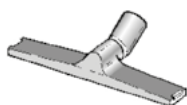

DV-ACC-114

Floor bar
housing for
combined brush

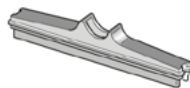

DV-ACC-102

Floor bar insert
for liquids

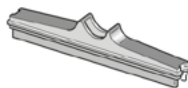

DV-ACC-101

Floor bar insert
for hard floors



DV-ACC-100

Floor bar insert
for carpets



DV-ACC-105

 Triangular
accessory

DV-ACC-110

Round brush.



DV-ACC-124

 Multi-diameter
adapter

DV-ACC-111

Pre Filter



DV-ACC-106

 Foam filter for
vacuuming liquids

DV-ACC-106

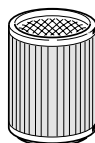
 Exhaust Post
Filter
(cellulose fibre +
HEPA)

DV-ACC-504

 "IFA" filter
cartridge
Class 'M'
for DV 80

DV-ACC-501

 "IFA" double-
layer fleece filter
bag Class 'M'
for DV80



OPERATION

ATTACHING THE TRANSPORT HANDLE

Fit the transport handle (A) on the drum (B) inserting it in the side seats.

Lock with the tightening screws (D)

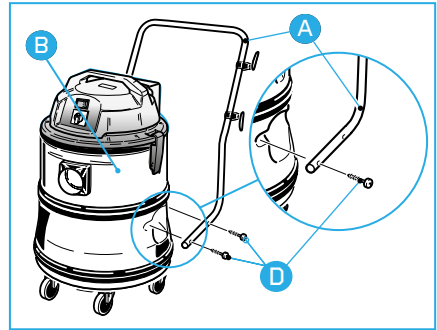

RELEASING THE MOTOR UNIT

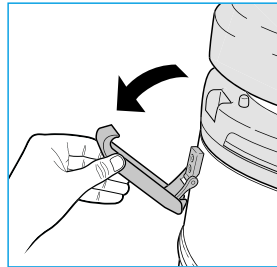
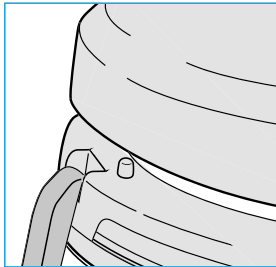

To release the motor unit.

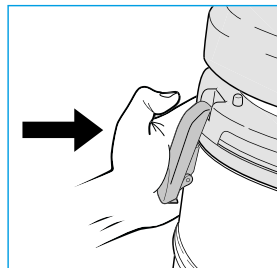
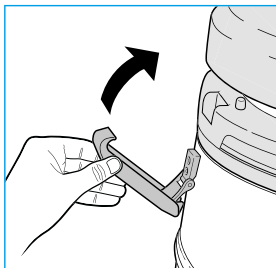

To refit the motor unit.



POWER CORD STORAGE REEL

Hook (E) position as shown in the figure.

To unwind the power cord, turn the hooks (E).

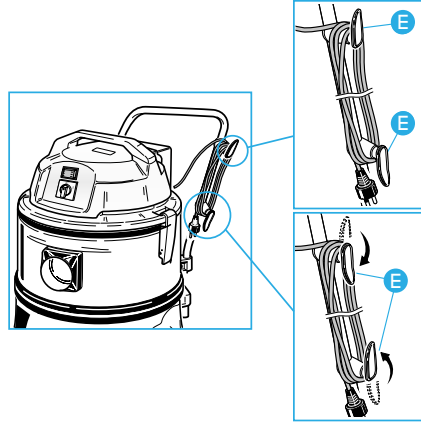

SWITCHING ON

Warning light (A)

Power switch (B):
position "O" - Appliance off
position "I" - Appliance on.

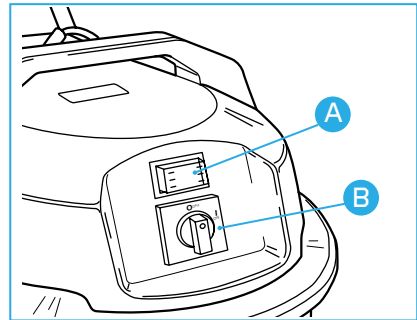

ATTACHING THE FLEXIBLE HOSE

Attach the connector of the flexible hose (U) to the air inlet connector (R).

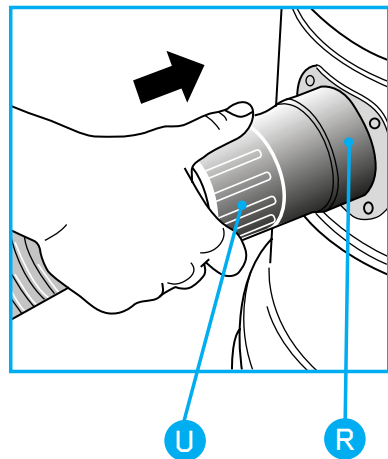



FILTER SYSTEMS

USING THE FILTER



To vacuum Class 'M' dust always use the filter element. Avoid using the filter for sharp or damp materials .

Place the filter (B) on the motor housing (C).

Fit the plastic disc (A) onto the filter (B)



We strongly recommend using this filter when vacuuming dust and solids; it can be used along with the filter paper bag. This helps prevent the filter unit from clogging, and has the advantage of making the disposal of vacuumed debris quick and sanitary. Avoid using them for cutting or damp materials.

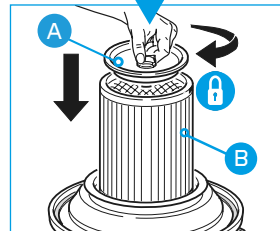
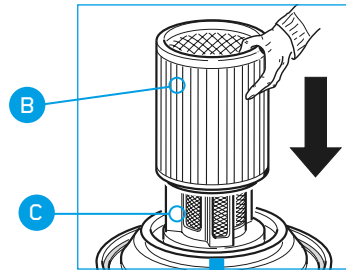
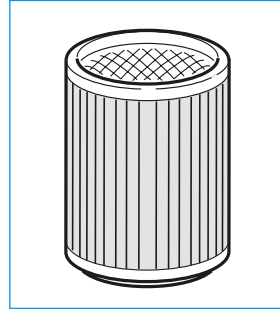

The filter cartridge should always be used. Keep the filter cartridge clean. Replace it if overly caked or worn.

USING THE DUST BAG



Use the dust bag only when the filter cartridge is installed. To pick up dust of class 'M' the dust bag must be installed in the appliance.

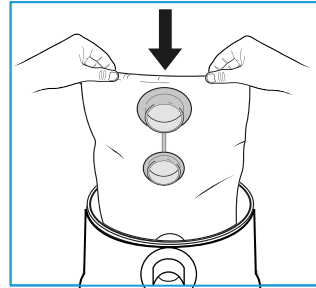

Introduce the fibre bag into the waste drum.

Fit the plastic flange (X) into the air inlet connector (Y). Be careful not to damage the bag.

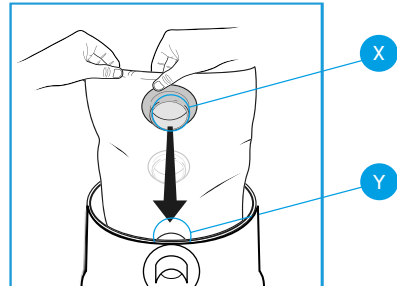

Change the bag when the warning light (B) comes on.

CHANGING THE DUST BAG



The bag should not be reused and must always be changed.

Dispose of the bag in compliance with the special waste disposal regulations in force in your country

Remove the plastic flange (1) from the air inlet connector (2). Take out the full bag. Close the plastic flange with the cap provided.

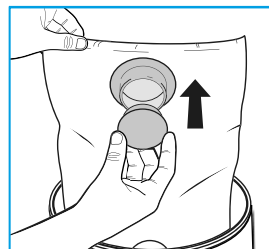
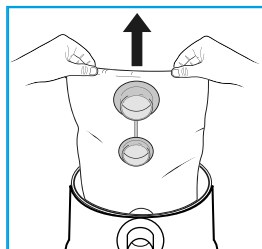
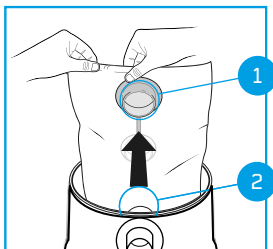



USING THE PRE-FILTER (OPTIONAL)

Use the filter element to increase filtration “performance”
Attach the prefilter (P) to the rim of the basket (G)

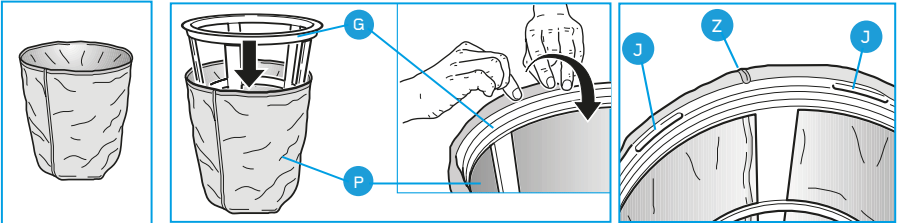

The seam (Z) on the side of the prefilter should not overlap the hooks (J) on the basket (G).

Fit the ring (F) to the basket (G) and insert the pre-filter assembly in the drum.

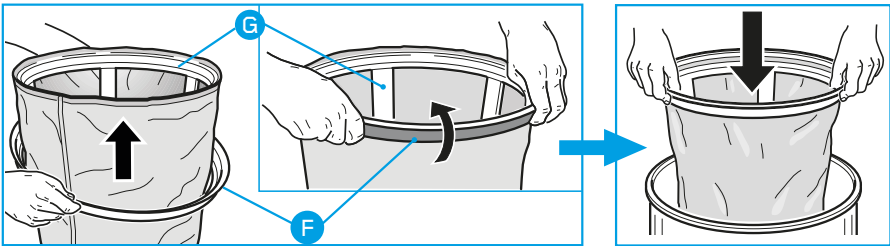

AIR OUTLET POST-FILTER

The post-filter guarantees that the air recirculated into the environment is free of impurities.

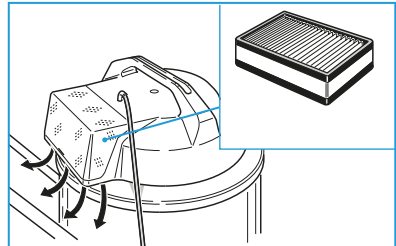

USING THE FOAM FILTER (WET VACUUM)

To vacuum liquids, **ALWAYS** use the foam filter.



The elastic on the foam filter must fit over the edge (V).

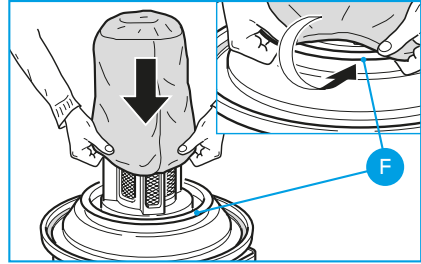

Always remove the filter cartridge and the paper filter bag, if fitted. Use the foam filter. The foam filter is not suitable for vacuuming Class 'M' dust.

When the vacuumed liquids reach the maximum level inside the drum, suction is automatically cut off by the safety float. The user is alerted by an increase in the RPM rate of the motor and the lack of suction. Turn off the appliance immediately and empty the drum.

VACUUMING LARGE QUANTITIES OF LIQUID

To ensure partial airflow, make sure that the crevice tool is never fully submerged.

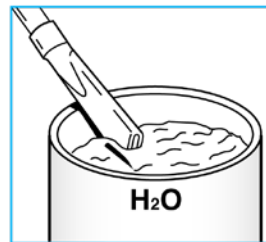

CLEANING THE FOAM FILTER

Rinse the foam filter with water. **DO NOT** use detergent. Replace if worn or torn.

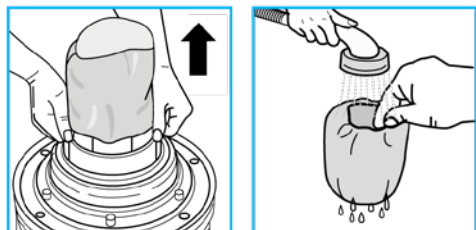



PROPER USE



The discharge tap (K) must be closed to prevent the vacuumed material escaping.

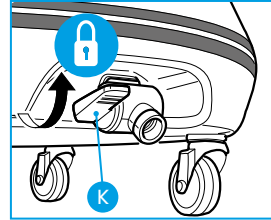

USING THE BLOWER FUNCTION



The blower function can be used only in absence of 'L' and 'M' category powders.

Remove container (P) with the HEPA exhaust filter

Attach the flexible hose connector (U) to the exhaust connector (R) and turn it clockwise.

Turn on the Appliance. (See Page 15)

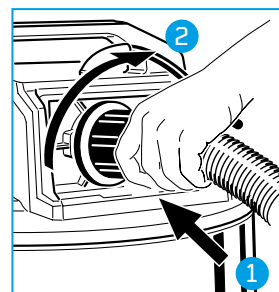
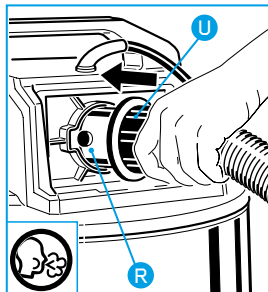
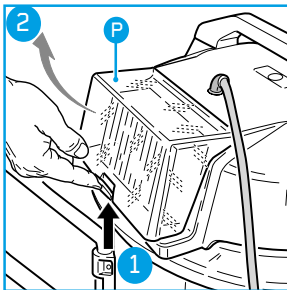

MAINTENANCE



Always unplug the appliance from the power supply before cleaning or servicing the filter system in any way.

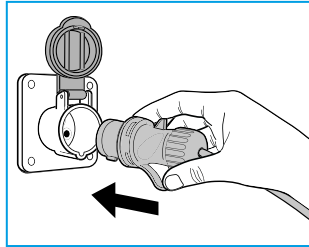

CLEANING THE FILTER CARTRIDGE

Remove the filter from the motor support.

Clean the filter cartridge frequently with a soft-bristled brush.

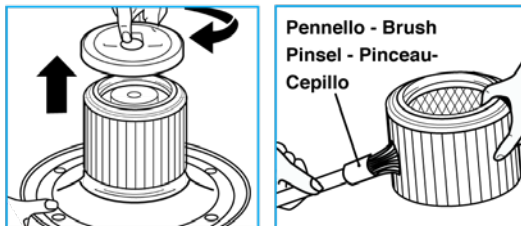

NEVER wash the filter cartridge with water and/or other liquids.



CLEANING THE PRE-FILTER FILTER

To clean the prefilter basket, shake it out into the trash.
Blow on it if necessary.
Replace it if worn.

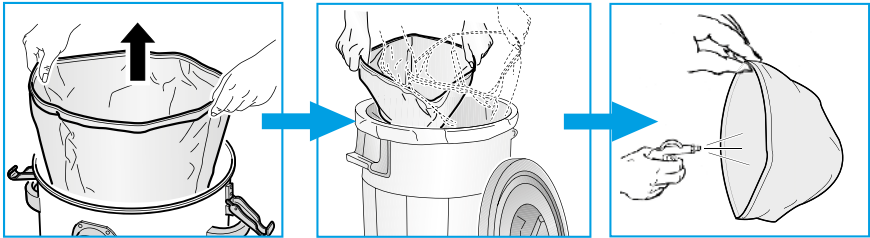

NEVER wash the canister pre-filter with water and/or other liquids.

CLEANING THE EXHAUST FILTER

Replace the post-filter periodically:

Release the container (P), remove the exhaust filter; Position the new exhaust filter so that the seal (O) is facing the outside of the container (P); close the container (P).

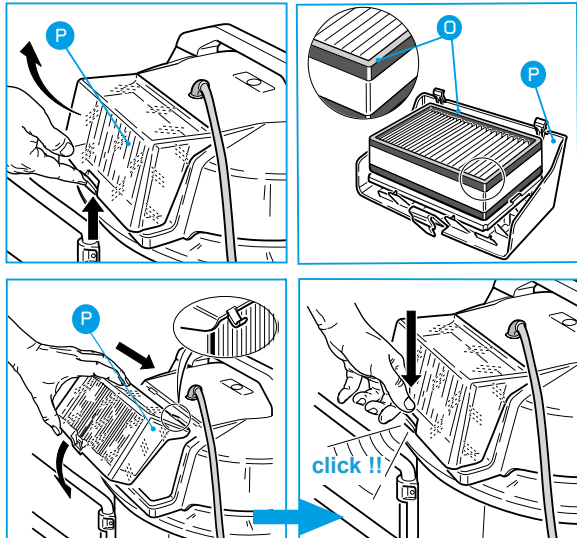

CLEANING THE DRUM

After vacuuming liquids, empty the drum and rinse it together with the accessories in order to prevent scale from forming.

To empty the drum-container after sucking up liquid substances open the drain tap (K) with motor OFF.

Frequently wash the seat where the safety float slides in order to ensure it's properly functioning.

Before vacuuming Class 'M' dust again make sure that the filter element and the bag are fitted.

Wash the drum after each use.

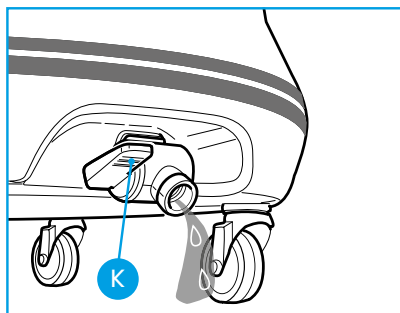



TROUBLESHOOTING

Problems	Causes	Solutions
The appliance will not start	No power Defective power cord, switches or motor.	Check that the power socket is working Contact your technical service centre (see attached list).
Reduced Efficiency	Drum too full Filter cartridge is dirty or caked. Clogged tube or accessories.	Empty Drum Thoroughly clean or change the filter, Check the hose or accessories.
The RPM rate of the motor is noticeably higher.	Drum too full. Filter cartridge is dirty or caked. Clogged tube or accessories. Drain tap (K) open	Check the drum. Thoroughly clean or change the filter, Check the hose or accessories. Close the drain tap (K)
The dust goes out from the exhaust post-filter.	Main filter is damaged or torn.	Check the filter and replace it if necessary.



Do not dispose of electrical appliances with household waste!

In compliance with European Directive 2012/19/EU on waste electrical and electronic equipment (WEEE) and its implementation in accordance with national law, electric tools that have reached the end of their lifecycle must be collected separately and returned to an environmentally compatible recycling facility.

"EC" DECLARATION OF CONFORMITY"

The manufacturer declares that the products described in these instructions

DV80 MBN

Comply with the essential requisites of European Directives:

2014/35 / EU

2014/30 EU

2011/65 / EU

and is in accordance with standards

EN 60335-1: 2012 + A11: 2014

EN 60335-2-69:2012

EN 62233: 2008

EN 55014-1: 2006 + A1: 2009 + A2: 2011

EN 55014-2: 2015

EN 61000-3-2: 2014

EN 61000-3-3: 2014

This declaration was drawn up in October 2016.



DEUTSCH

ANWEISUNG HANDBUCH

WARNUNGEN	26
BESCHREIBUNG SYMBOLE ANWEISUNGEN	31
SCHLÜSSEL FÜR SYMBOLE	31
TECHNISCHE SPEZIFIKATIONEN	32
ZUBEHÖR	33
BEDIENUNG	35
FILTERSYSTEME	37
ORDNUNGSGEMÄSSE VERWENDUNG	41
WARTUNG	42
FEHLERBEHEBUNG	45
EU-KONFORMITÄTSERKLÄRUNG	46

WARNUNGEN



Die in diesem Handbuch beschriebenen Geräte sind geeignet für:

- Staub und Flüssigkeiten absaugen.
- Professionelle Nutzung (z.B. in Hotels, Schulen, Krankenhäusern, Fabriken, Geschäften, Büros und Vermietungsagenturen).
- Die Kategorie “M” eignet sich für die Abscheidung von trockenen Pulvern (solange sie nicht explosiv, entzündlich und/oder karzinogen sind) mit einer maximalen Durchlässigkeit $<0,1\%$ und MAC (Maximum Allowable Concentration) $\geq 0.1 \text{ mg/m}^3$

Bewahren Sie diese Bedienungsanleitung sorgfältig auf.

- Ein Elektrogerät ist kein Spielzeug. Verwenden und lagern Sie es außerhalb der Reichweite von Kindern. Kinder müssen beaufsichtigt werden, um sicherzustellen, dass sie nicht mit dem Gerät spielen.
- Bewahren Sie die Verpackungskomponenten (Karton, PSE-Schutz usw.) außerhalb der Reichweite von Kindern auf.
- Dieses Gerät ist nicht für die Verwendung durch Personen (einschließlich Kinder) mit eingeschränkten körperlichen, sensorischen und geistigen Fähigkeiten oder Personen, die diese Gebrauchsanweisung nicht zuerst gelesen haben, vorgesehen.
- Dieses Gerät ist nur für den Betrieb mit Wechselstrom ausgelegt. Prüfen Sie vor der Inbetriebnahme des Gerätes, ob die Netzspannung mit der auf dem Typenschild angegebenen Spannung übereinstimmt.

- Kontrollieren Sie, ob die elektrische Anlage mit einem Differentialschalter ausgestattet ist (Typ automatische Abschaltung)
- Verwenden Sie ein Verlängerungskabel nur in einwandfreiem Zustand und achten Sie darauf, dass der Querschnitt der Leistung des Geräts plus der Leistung des Elektrowerkzeugs entspricht.
- Lassen Sie das Gerät niemals unbeaufsichtigt laufen.
- Wenn die Abluft wieder in die Arbeitsumgebung freigesetzt wird, muss sie einen ausreichenden Luftwechselindex der Klasse "M" aufweisen. Um die geforderten Grenzwerte einzuhalten, darf die Durchflussmenge maximal 50% der Frischluftmenge (Volumen der Umgebung VR nach Luftwechselzahl LW) betragen. Außerdem müssen die geltenden Vorschriften eingehalten werden.
- Wickeln Sie das Netzkabel vollständig ab, bevor Sie das Gerät in Betrieb nehmen.
- Richten Sie den Saugschlauch nicht auf Ohren, Augen, Haare, Personen oder Tiere im Allgemeinen.
- Während des Transports des Geräts muss der Motor ausgeschaltet sein. Achten Sie auch darauf, dass das Gerät keinen Staub in die Umgebung abgeben kann und dass es sich in einer stabilen Position befindet.
- Schalten Sie die Maschine bei hoher Staubemission, Feuer oder Rauch ab. Die Benutzung des Geräts ist nur nach Überprüfung und Reparatur durch eine autorisierte Person erlaubt.
- Ziehen Sie den Netzstecker immer sofort nach dem Gebrauch und vor jeder Reinigung oder Wartung des Geräts aus der Steckdose.

Sturzgefahr:

Nicht auf den Deckel des Geräts klettern oder sich darauf setzen.



WARNUNGEN

- Reparaturen dürfen nur von Fachleuten durchgeführt werden, die die vom Hersteller gelieferten Original-Ersatzteile aufbewahren. **Das Gerät selbst zu reparieren, kann äußerst gefährlich sein.**
- Gemäss den geltenden Vorschriften müssen Geräte, die entsorgt werden sollen, vor der Entsorgung durch Abtrennen des Netzkabels unbrauchbar gemacht werden.
- Das Gerät sollte mit Hilfe von Staubsaugern dekontaminiert und sauber gewischt oder mit Dichtungsmasse behandelt werden, bevor es aus einem Gefahrenbereich herausgebracht wird. Alle anderen Geräteteile sind als kontaminiert anzusehen, wenn sie aus dem Gefahrenbereich entfernt und geeignete Maßnahmen zur Verhinderung der Staubverteilung getroffen werden.
- Es wird empfohlen, während der Reinigung und Wartung stets persönliche Schutzeinrichtungen (Handschuhe und Maske) zu tragen, wie es die geltenden nationalen Vorschriften vorschreiben.
- Reinigen Sie den Ort, an dem die Wartung durchgeführt wird, um zu verhindern, dass gefährliche Stoffe in die Umwelt gelangen.

Benutzen Sie das Gerät niemals:

- Wenn Ihre Hände nass oder feucht sind;
- Wenn es heruntergefallen ist und offensichtliche Schäden oder Fehlfunktionen aufweist;
- Wenn das Stromkabel oder der Stecker defekt ist.



**Reinigen Sie das Gerät nur mit Wasser.
Verwenden Sie kein Trichlorethylen,
Lösungsmittel oder Scheuermittel.**

- Bevor mit den Wartungsarbeiten begonnen wird, wird dringend empfohlen, das Gerät zunächst einige Minuten lang durch Absaugen sauberer Luft zu dekontaminieren und außen zu reinigen.
- Die Wartungs- und Reinigungsarbeiten müssen in einem Raum mit ausreichender Belüftung und in einer Weise durchgeführt werden, dass weder das Bedienungspersonal noch andere Personen gefährdet werden.
- Bei Wartungs-, Reparatur- und Entsorgungsarbeiten sind alle kontaminierten Teile des Gerätes, die nicht vollständig gereinigt werden können, zu beseitigen; sie sind in undurchlässige Säcke gemäß den geltenden nationalen Vorschriften für die Entsorgung von Sondermüll zu verpacken.
- Zur ordnungsgemäßen Entsorgung ist es ratsam, auf dem undurchlässigen Beutel anzugeben, welche Stoffe abgesaugt wurden.
- Es wird empfohlen, mindestens einmal pro Jahr eine technische Inspektion des Gerätes durchzuführen, um die Dichtigkeit der Verschlüsse und das einwandfreie Funktionieren der Kontrollmechanismen zu überprüfen, damit eventuelle Fehlfunktionen erkannt werden können. Tägliche Überprüfung der Integrität des Filtersystems.
- Dieses Gerät wurde so konzipiert, dass es von entsprechend geschulten Personen benutzt werden kann, insbesondere in Bezug auf die Reinigung und Wartung des Geräts, die Risiken, die sich aus dem abgesaugten Material und dessen ordnungsgemäßer Entsorgung ergeben, sowie den Austausch von Ersatzteilen gemäß den in den verschiedenen Ländern geltenden Richtlinien.
- Saugen Sie keine entflammaren, explosionsgefährdeten oder ätzenden Stoffe und keine glühende Asche auf. Diese Stoffe können die Sicherheit und den Betrieb des Gerätes beeinträchtigen.



Wenn das Stromkabel beschädigt ist, muss es durch den Hersteller oder ein zugelassenes technisches Servicezentrum oder auf jeden Fall durch eine Person mit ähnlicher Qualifikation ersetzt werden, um jegliches Risiko zu vermeiden.



- Stellen Sie das Netzkabel niemals auf scharfe Kanten, quetschen Sie es nicht und halten Sie es von den rotierenden Elektrobürsten fern.
- Verwenden Sie die Steckdose (falls vorhanden) an der Maschine nur für die in der Anleitung angegebenen Zwecke.
- Bei Undichtigkeiten (Schaum oder Flüssigkeit) schalten Sie das Gerät sofort aus.

GARANTIE

- Dieses Gerät darf nur in Innenräumen gelagert werden.
- Reinigen Sie den Sitz, auf dem der Sicherheitsschwimmer gleitet, häufig und überprüfen Sie ihn regelmäßig auf seine Unversehrtheit.
- Verwenden Sie das Gerät nicht, wenn das Filtersystem beschädigt ist.
- Die Staubklasse 'M' gilt nicht für das Saugen von Flüssigkeiten.

DENKEN SIE DARAN, DASS

- Falls potenziell gefährliche Stoffe mit den Augen oder der Haut in Kontakt kommen, spülen Sie mit Wasser aus und wenden Sie sich an ein Fachzentrum.
- Falls potenziell gefährliche Stoffe eingeatmet oder verschluckt wurden, rufen Sie einen Arzt. Verursachen Sie kein Erbrechen, um eine Kontamination der Lungen zu vermeiden; es wird empfohlen, den Mund zu spülen, ohne Wasser zu schlucken.
- Falls bei spontanem Erbrechen potenziell gefährliche Substanzen in die Lungen gelangt sein sollten, Transport ins Krankenhaus.

Der Hersteller lehnt jede Verantwortung für unsachgemäßen Gebrauch oder Nichtbeachtung der mitgelieferten Anweisungen, Manipulation und unangemessene Wartung des Geräts ab.

SYMBOLS

BESCHREIBUNG SYMBOLE ANWEISUNGEN



Lesen Sie
die Gebrauchsanweisung vor dem Gebrauch des Geräts.



Achtung
weist auf eine potentielle Gefahrensituation hin.



Hinweis
Warnung vor der ordnungsgemäßen Verwendung



Benutzerhandbuch
Gebrauchsanweisung

SCHLÜSSEL ZU DEN SYMBOLEN



Sockel für Elektrowerkzeuge



Anschluss für pneumatische Werkzeuge



Nass- und Trockensauger



“Funktion Selbstreiniger Filter



Professionell





Gebläseanschluss



Industrie

TECHNISCHE SPEZIFIKATIONEN

DV80

Versorgungsspannung	120 V~ 230 V~
Häufigkeit	50/60 Hz
Leistung	120V = 2400 W 230V = 2400 W
Maximaler Luftstrom ca.	110 L/sec
Trommel aus	
Nennkapazität der Trommel	80
MAX Absaugung ca.	24 kPa
Motor-Isolationsklasse	
Geräte-Isolationsklasse	I ^a
Motortyp	Bypass mit hohem Wirkungsgrad
Ungefähre Appliance- Abmessungen	540 x 710 x 950 mm
Verpackungsgröße ca.	620 x 660 x 8850 mm
Gewicht des verpackten Geräts ca.	31 Kg
Gewicht des Geräts *	25.2 Kg
Konstanter und gewichteter Schalldruckpegel	< 69 dB(A)

* Gewicht nach dem Verfahren EPTA 01/2003

ZUBEHÖR

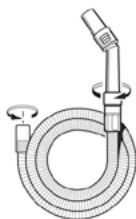

DV-ACC-506

∅45 mm flexibler
Schlauch mit
ergonomischem
Greif- und
Abwärtsflussvor-
richtung



DV-ACC-115

Kunststoff-Ver-
längerungsstäbe



DV-ACC-104

Spalt-Werkzeug

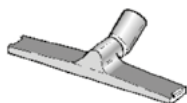

DV-ACC-114

Bodenleistenge-
häuse für kombi-
nierte Bürste

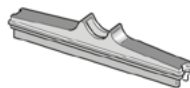

DV-ACC-102

Bodenleistenein-
satz für Flüssig-
keiten

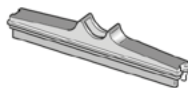

DV-ACC-101

Bodenleistenein-
satz für harte
Böden



DV-ACC-100

Bodenleistenein-
satz für Teppiche



DV-ACC-105

Dreieckiges
Zubehör



DV-ACC-110

Rundpinsel.



DV-ACC-124

Adapter mit
mehreren
Durchmessern



DV-ACC-111

Pre Filter



DV-ACC-106

Schaumstofffilter
zum Absaugen
von Flüssigkeiten

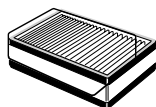

DV-ACC-106

Auspuff-
Säulenfilter
(Zellulosefaser +
HEPA)

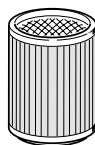

DV-ACC-504

Filterpatrone
"IFA"
Klasse "M".
für DV 80



DV-ACC-501

Doppellagiger
Vliesfilterbeutel
"IFA" Klasse "M"
für DV80

BETRIEB

DEN TRANSPORTHANDEL ERREICHEN

Den Transportgriff (A) an der Trommel (B) anbringen und in die Seitensitze einführen.

Mit den Spannschrauben (D) verriegeln

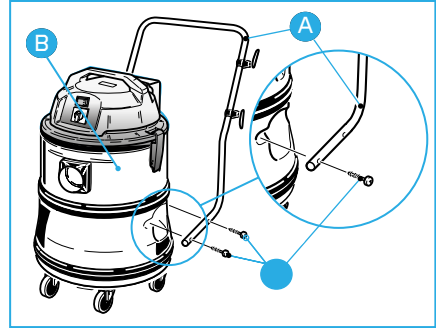

FREIGEBEN DER MOTOREINHEIT

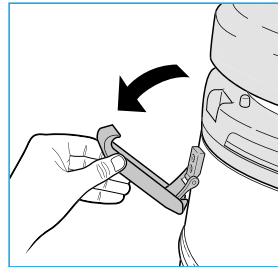
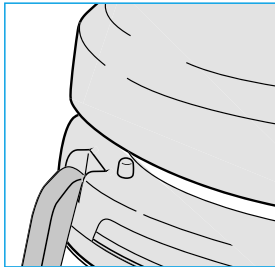

Zum Lösen der Motoreinheit.

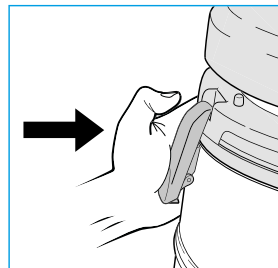
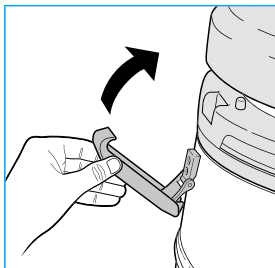

Zum Nachrüsten der Motoreinheit.

NETZKABEL- SPEICHERROLLE

Position des Hakens (E) wie in der
Abbildung gezeigt.

Um das Netzkabel abzuwickeln, drehen
Sie die Haken (E).

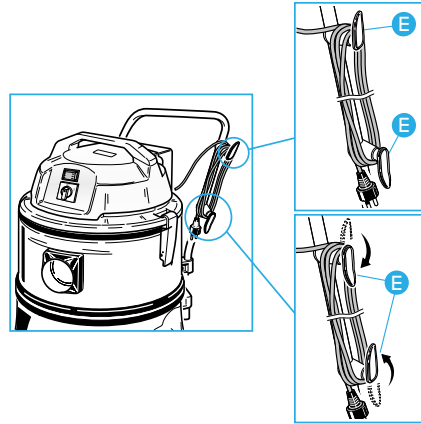

EINSCHALTEN

Warnleuchte (A)

Netzschalter (B):
Stellung "O" - Gerät aus
Position "I" - Gerät an.

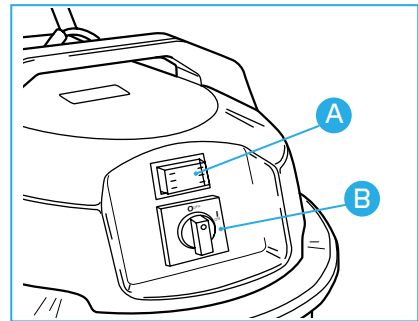

ANSCHLUSS AN DEN FLEXIBLEN SCHLAUCH

Bringen Sie den Anschluss des flexiblen
Schlauchs (U) am Lufteinlassanschluss
(R) an.

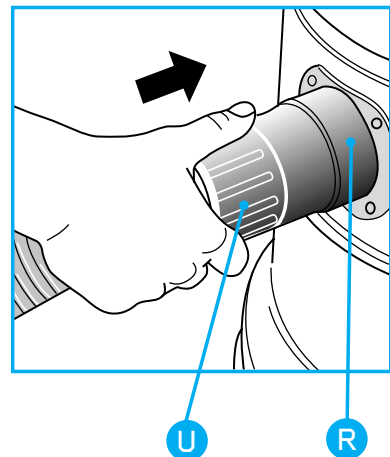

FILTERSYSTEME

VERWENDUNG DES FILTERS



Zum Absaugen von Staub der Klasse 'M' immer das Filterelement verwenden. Vermeiden Sie die Verwendung des Filters für scharfe oder feuchte Materialien.

Setzen Sie den Filter (B) auf das Motorgehäuse (C).

Setzen Sie die Kunststoffscheibe (A) auf den Filter (B) auf.



Wir empfehlen dringend, diesen Filter beim Absaugen von Staub und Feststoffen zu verwenden; er kann zusammen mit dem Filterpapierbeutel verwendet werden. Dies trägt dazu bei, ein Verstopfen der Filtereinheit zu verhindern, und hat den Vorteil, dass der gesaugte Schmutz schnell und hygienisch entsorgt werden kann.

Vermeiden Sie die Verwendung zum Schneiden oder für feuchte Materialien.

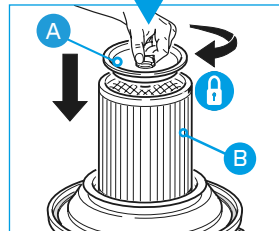
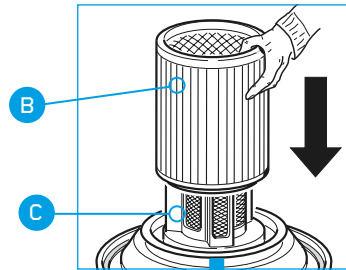
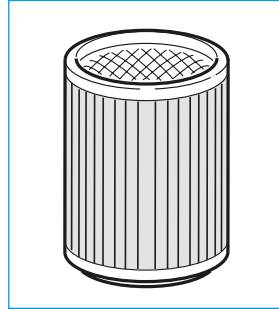

Die Filterpatrone sollte immer verwendet werden. Halten Sie die Filterpatrone sauber. Ersetzen Sie sie, wenn sie übermäßig verbacken oder verschlissen ist.

VERWENDUNG DES STAUBBEUTELS



Verwenden Sie den Staubbeutel nur, wenn die Filterpatrone installiert ist. Zur Aufnahme von Staub der Klasse 'M' muss der Staubbeutel im Gerät installiert sein.

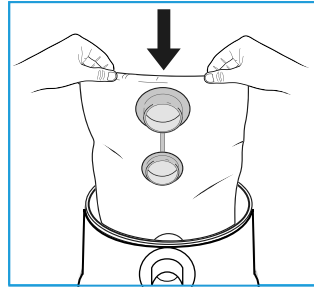

Führen Sie den Fasersack in die Abfalltrommel ein.

Setzen Sie den Kunststoffflansch (X) in den Lufteinlassanschluss (Y) ein. Achten Sie darauf, den Beutel nicht zu beschädigen.

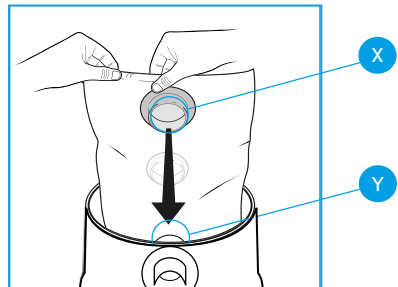

Wechseln Sie den Sack aus, wenn die Warnleuchte (B) aufleuchtet.

WECHSELN DES STAUBBEUTELS



Der Beutel darf nicht wiederverwendet werden und muss immer gewechselt werden.

Entsorgen Sie den Beutel in Übereinstimmung mit den in Ihrem Land geltenden Sondermüllentsorgungsvorschriften

Entfernen Sie den Plastikflansch (1) vom Lufteinlassanschluss (2) und nehmen Sie den vollen Beutel heraus. Verschließen Sie den Plastikflansch mit der mitgelieferten Kappe.

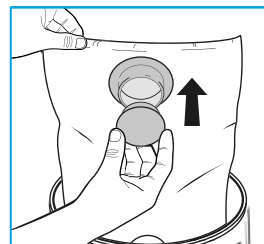
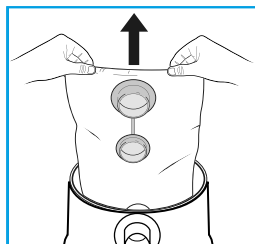
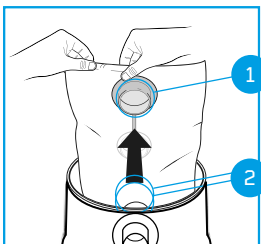



VERWENDUNG DES PRE-FILTERS (OPTIONAL)

Verwenden Sie das Filterelement, um die "Leistung" der Filtration zu erhöhen
Befestigen Sie den Vorfilter (P) am Rand des Korbes (G)

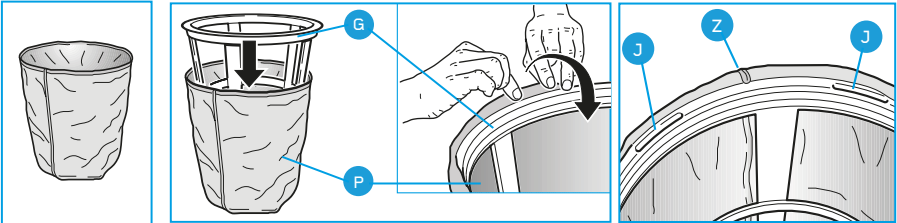

Die Naht (Z) an der Seite des Vorfilters sollte die Haken (J) am Korb (G) nicht überlappen.

Montieren Sie den Ring (F) auf den Korb (G) und setzen Sie die Vorfilterbaugruppe in die Trommel ein.

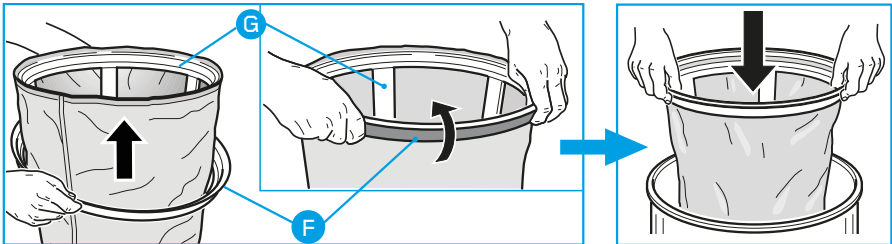

LUFTAUSLASS-NACHFILTER

Der Nachfilter garantiert, dass die in die Umgebung zurückgeführte Luft frei von Verunreinigungen ist.

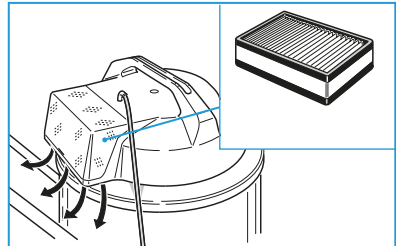

UNTER VERWENDUNG DES FOAM-FILTERS (NASSSAUGEN)

Zum Absaugen von Flüssigkeiten verwenden Sie **IMMER** den Schaumstofffilter.

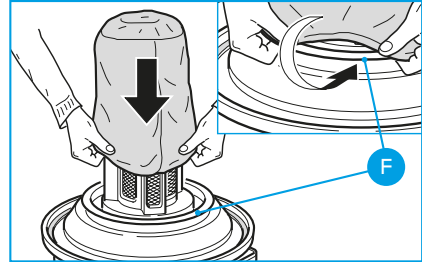

Das Gummiband am Schaumstofffilter muss über den Rand passen (v).



Entfernen Sie immer die Filterpatrone und den Papierfilterbeutel, falls vorhanden. Verwenden Sie den Schaumstofffilter. Der Schaumstofffilter ist nicht zum Aufsaugen von Staub der Klasse "M" geeignet.

Wenn die abgesaugten Flüssigkeiten den maximalen Füllstand in der Trommel erreichen, wird die Absaugung automatisch durch den Sicherheitsschwimmer unterbrochen. Der Benutzer wird durch eine Erhöhung der Motordrehzahl und das Ausbleiben der Absaugung alarmiert. Schalten Sie das Gerät sofort aus und entleeren Sie die Trommel.

ABSAUGEN GROSSER FLÜSSIGKEITSMENGEN

Um einen teilweisen Luftstrom zu gewährleisten, stellen Sie sicher, dass das Spaltwerkzeug niemals vollständig untergetaucht ist.

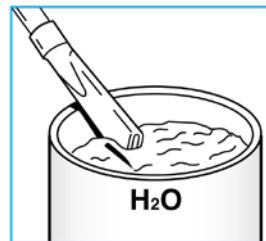

REINIGUNG DES SCHAUMS FILTERN

Spülen Sie den Schaumstofffilter mit Wasser aus. Verwenden Sie **KEIN** Reinigungsmittel. Ersetzen Sie ihn, wenn er verschlissen oder gerissen ist.

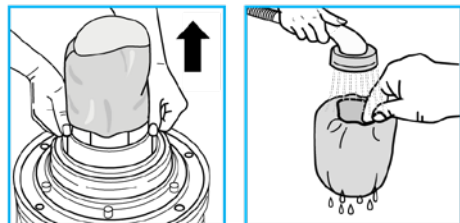

VORTEILIGE VERWENDUNG



Der Auslasshahn (K) muss geschlossen sein, um ein Entweichen des abgesaugten Materials zu verhindern.

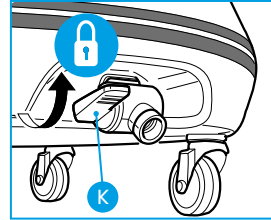

VERWENDUNG DER GEBLÄSEFUNKTION



Die Gebläsefunktion kann nur verwendet werden, wenn keine Pulver der Kategorien "L" und "M" vorhanden sind.

Behälter (P) mit dem HEPA-Abluftfilter entfernen

Stecken Sie den flexiblen Schlauchanschluss (U) auf den Auslassanschluss (R) und drehen Sie ihn im Uhrzeigersinn.

Schalten Sie das Gerät ein. (Siehe Seite 36)

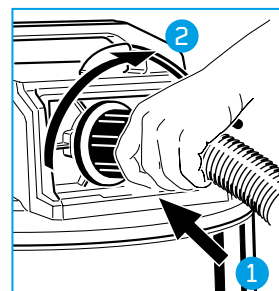
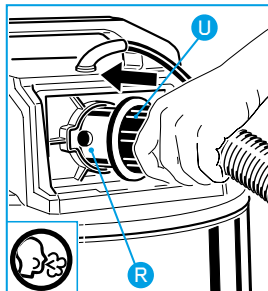
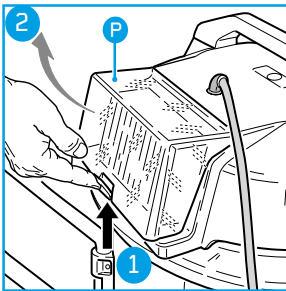

WARTUNG



Ziehen Sie immer den Netzstecker des Geräts aus der Steckdose, bevor Sie das Filtersystem in irgendeiner Weise reinigen oder warten.

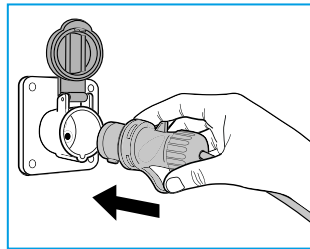

REINIGUNG DER FILTERPATRONE

Entfernen Sie den Filter von der Motorhalterung.

Reinigen Sie die Filterpatrone häufig mit einer Bürste mit weichen Borsten.

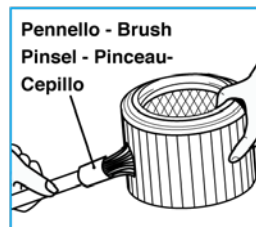
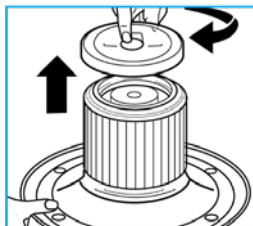

Waschen Sie die Filterpatrone **NIEMALS** mit Wasser und/oder anderen Flüssigkeiten.

REINIGUNG DES VORFILTERFILTERS

Um den Vorfilterkorb zu reinigen, schütteln Sie ihn in den Papierkorb aus.
Pusten Sie ihn gegebenenfalls an.
Ersetzen Sie ihn, wenn er verschlissen ist.

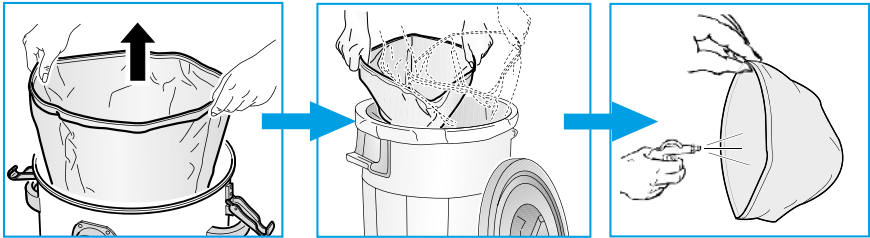

NIEMALS den Kanister-Vorfilter mit Wasser und/oder anderen Flüssigkeiten waschen.

REINIGUNG DES ABGASFILTERS

Ersetzen Sie den Nachfilter periodisch:

Lösen Sie den Behälter (P), entfernen Sie den Abluftfilter;
Den neuen Auspufffilter so positionieren, dass die Dichtung (O) zur Außenseite des Behälters (P) zeigt;
den Behälter (P) schließen.

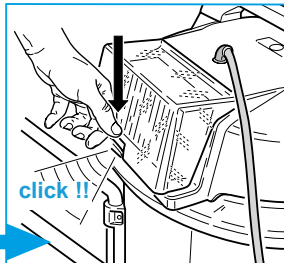
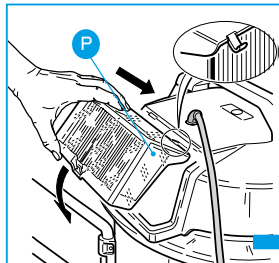
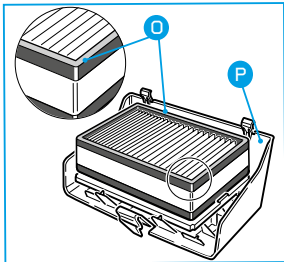
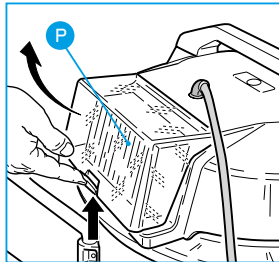

REINIGUNG DER TROMMEL

Nach dem Absaugen von Flüssigkeiten ist die Trommel zu entleeren und zusammen mit dem Zubehör zu spülen, um die Bildung von Kesselstein zu verhindern.

So entleeren Sie den Fassbehälter nach dem Aufsaugen von Flüssigkeit
Stoffe bei ausgeschaltetem Motor den Ablasshahn (K) öffnen.

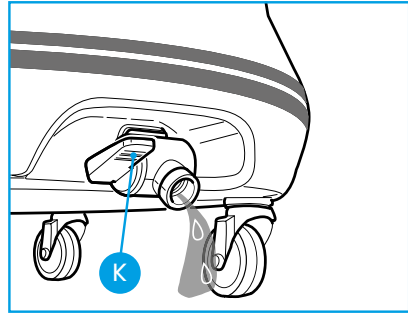

Waschen Sie den Sitz, auf dem der Sicherheitsschwimmer gleitet, häufig, um sicherzustellen, dass er ordnungsgemäß funktioniert.

Vor dem erneuten Absaugen von Staub der Klasse 'M' sicherstellen, dass das Filterelement und der Beutel montiert sind.

Waschen Sie die Trommel nach jedem Gebrauch.



FEHLERBEHEBUNG

Probleme	Ursachen	Lösungen
Das Gerät wird nicht starten	Keine Macht Defektes Netzkabel, Schalter oder Motor.	Prüfen Sie, ob die Steckdose funktioniert Wenden Sie sich an Ihr technisches Dienstleistungszentrum (siehe beigefügte Liste).
Ermäßigt Effizienz	Trommel zu voll Filterpatrone ist verschmutzt oder verbacken. Rohr oder Zubehör ist verstopft.	Leere Trommel Reinigen Sie den Filter gründlich oder wechseln Sie ihn aus, Überprüfen Sie den Schlauch oder das Zubehör.
Die Drehzahl des Motors ist merklich höher.	Trommel zu voll. Filterpatrone ist verschmutzt oder verkrustet. Rohr oder Zubehör verstopft. Ablasshahn (K) offen	Prüfen Sie die Trommel. Reinigen Sie den Filter gründlich oder wechseln Sie ihn aus, Überprüfen Sie den Schlauch oder das Zubehör. Schließen Sie den Ablasshahn (K)
Der Staub tritt aus dem Auspuff aus. Nachfilter.	Der Hauptfilter ist beschädigt oder gerissen.	Überprüfen Sie den Filter und tauschen Sie ihn gegebenenfalls aus.



Entsorgen Sie keine Elektrogeräte mit Hausmüll!

In Übereinstimmung mit der Europäischen Richtlinie 2012/19/EU über Elektro- und Elektronik-Altgeräte (WEEE) und deren Umsetzung in nationales Recht müssen Elektrowerkzeuge, die das Ende ihres Lebenszyklus erreicht haben, getrennt gesammelt und einer umweltverträglichen Recyclinganlage zugeführt werden.

“EC”-ERKLÄRUNG VON KONFORMITÄT“.

Der Hersteller erklärt, dass die in dieser Anleitung beschriebenen Produkte

DV80 MBN

Erfüllen Sie die wesentlichen Anforderungen der europäischen Richtlinien:

2014/35 / EU

2014/30 EU

2011/65 / EU

und mit den Normen übereinstimmt

EN 60335-1: 2012 + A11: 2014

EN 60335-2-69-2012

EN 62233: 2008

EN 55014-1: 2006 + A1: 2009 + A2: 2011

EN 55014-2: 2015

EN 61000-3-2: 2014

EN 61000-3-3: 2014

Diese Erklärung wurde im Oktober 2016 verfasst.



NEDERLAND

INSTRUCTIE HANDLEIDING

WAARSCHUWINGEN	48
BESCHRIJVINGSSYMBOLEN INSTRUCTIES	53
KEY TO SYMBOLS	53
TECHNISCHE SPECIFICATIES	54
TOEGANGSMAATREGELEN	55
WERKING	57
FILTERSYSTEMEN	59
CORRECT GEBRUIK	63
ONDERHOUD	64
HET OPLOSSEN VAN PROBLEMEN	67
EU-VERKLARING VAN OVEREENSTEMMING	68

WAARSCHUWINGEN



De in deze handleiding beschreven apparaten zijn geschikt voor:

- Stof en vloeistoffen opzuigen.
- Professioneel gebruik (bijv. hotels, scholen, ziekenhuizen, fabrieken, winkels, kantoren en verhuurbedrijven).
- De 'M'-categorie is geschikt voor de afscheiding van droge poeders (zolang ze niet explosief, ontvlambaar en/of kankerverwekkend zijn) met een maximale doorlaatbaarheid $<0,1\%$ en MAC (Maximaal Toelaatbare Concentratie) $\geq 0,1\text{mg}/\text{m}^3$.

Bewaar deze handleiding zorgvuldig.

- Een elektrisch apparaat is geen speelgoed. Gebruik en bewaar het buiten het bereik van kinderen. Kinderen moeten onder toezicht staan om er zeker van te zijn dat ze niet met het apparaat spelen.
- Houd de verpakkingsonderdelen (kartonnen doos, PSE-beschermingen, enz.) buiten het bereik van kinderen.
- Dit apparaat is niet ontworpen voor gebruik door personen (inclusief kinderen) met verminderde fysieke, zintuiglijke en mentale vermogens, of die deze gebruiksaanwijzing niet eerst hebben gelezen.
- Dit apparaat is ontworpen om uitsluitend met wisselstroom te werken. Controleer voor het starten van het apparaat of de netspanning overeenkomt met de op het gegevensplaatje aangegeven spanning.

- Controleer of de elektrische installatie is uitgerust met een differentieelschakelaar (type automatische uitschakeling).
- Gebruik alleen een verlengkabel als deze in perfecte staat is en zorg ervoor dat de doorsnede geschikt is voor het vermogen van het apparaat plus het vermogen van het elektrische gereedschap.
- Laat het apparaat nooit onbeheerd draaien.
- Als de uitgeblazen lucht weer in de werkomgeving terechtkomt, moet deze een voldoende luchtverversingsindex van klasse 'M' hebben. Om de vereiste grenswaarden in acht te nemen, moet het debiet maximaal 50% van de verse luchtstroom zijn (volume van de omgeving VR door luchtverversingsindex LW). Ook moeten de geldende voorschriften in acht worden genomen.
- Wikkel de voedingskabel volledig af voordat u het apparaat in gebruik neemt.
- Richt de zuigslang niet op oren, ogen, haren, personen of dieren in het algemeen.
- Tijdens het transport van het apparaat moet de motor uitgeschakeld zijn. Zorg er ook voor dat het apparaat geen stof in de omgeving kan verspreiden en dat het in een stabiele positie staat.
- Schakel de machine uit in geval van hoge stofuitstoot, brand of rook. Gebruik van het apparaat is alleen toegestaan nadat het is gecontroleerd en gerepareerd door een bevoegd persoon.
- Trek altijd de stekker uit het stopcontact direct na gebruik en voordat u het apparaat reinigt of onderhoudt.

Risico om te vallen:

Klim niet op het deksel van het apparaat en ga er niet op zitten.



WAARSCHUWINGEN

- Reparaties mogen alleen worden uitgevoerd door specialisten die de originele, door de fabrikant geleverde reserveonderdelen bewaren.

Het zelf repareren van het apparaat kan zeer gevaarlijk zijn.

- In overeenstemming met de geldende voorschriften moeten apparaten die moeten worden weggegooid, onbruikbaar worden gemaakt door de stroomkabel door te knippen voordat ze worden weggegooid.
- Het apparaat moet worden gedecontamineerd met behulp van een stofzuiger en moet worden schoongemaakt of met kit worden behandeld voordat het uit een gevaarlijke omgeving wordt gehaald. Alle andere onderdelen van het apparaat moeten als verontreinigd worden beschouwd wanneer ze uit de gevaarlijke zone worden verwijderd en er moeten passende maatregelen worden genomen om te voorkomen dat het stof zich verspreidt.
- Tijdens de reiniging en het onderhoud wordt aanbevolen om altijd persoonlijke beschermingsmiddelen (handschoenen en masker) te dragen, zoals vereist door de geldende nationale regelgeving.

Gebruik het stopcontact (indien aanwezig) op de machine alleen voor de in de handleiding aangegeven doeleinden.

Gebruik het apparaat nooit:

- Als je handen nat of vochtig zijn;
- Als het is gevallen en duidelijke schade of storingen vertoont;
- Als de voedingskabel of de stekker defect is.

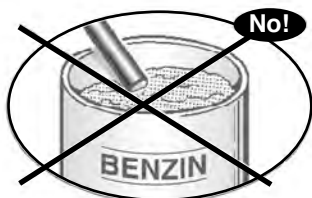

**Reinig het apparaat alleen met water.
Gebruik geen trichloorethyleen,
oplosmiddelen of schuurmiddelen.**

- Alvorens verder te gaan met het onderhoud wordt ten eerste aanbevolen het apparaat eerst te ontsmetten door enkele minuten schone lucht op te zuigen en het aan de buitenkant te reinigen.
- Onderhoud en reiniging moeten worden uitgevoerd in een ruimte met voldoende ventilatie en op een manier die de bedieners of andere personen niet in gevaar brengt.
- Reinig de plaats waar het onderhoud wordt uitgevoerd om te voorkomen dat gevaarlijke stoffen in het milieu terechtkomen.
- Tijdens het onderhoud, de reparatie en de verwijdering moeten alle verontreinigde onderdelen van het apparaat die niet volledig kunnen worden gereinigd, worden verwijderd; doe ze in ondoordringbare zakken volgens de geldende nationale voorschriften voor de verwijdering van speciaal afval.
- Voor een correcte verwijdering is het raadzaam om op de ondoordringbare zak aan te geven welke stoffen zijn opgezogen.
- Het wordt aanbevolen om het apparaat ten minste eenmaal per jaar aan een technische inspectie te onderwerpen om te controleren of de afdichtingen dicht zijn en of de controlemechanismen goed functioneren, zodat eventuele storingen kunnen worden opgespoord. Controleer dagelijks de integriteit van het filtersysteem.
- Dit apparaat is ontworpen voor gebruik door voldoende geschoolde personen, met name voor de reiniging en het onderhoud van het apparaat, de risico's die voortvloeien uit gestofzuigde materialen en de correcte verwijdering ervan, en de vervanging van reserveonderdelen volgens de richtlijnen die van kracht zijn in de verschillende landen.



Als de voedingskabel beschadigd is, moet deze worden vervangen door de fabrikant of een erkend technisch servicecentrum of in ieder geval door een persoon met een soortgelijke kwalificatie om elk risico te voorkomen.



- Zuig geen brandbare, potentieel explosieve of corrosieve stoffen en gloeiende as op. Deze stoffen kunnen de veiligheid en de werking van het apparaat in gevaar brengen.
- Leg het netsnoer nooit op scherpe randen, verpletter het niet en houd het uit de buurt van de roterende elektrische borstels.
- Schakel het apparaat bij lekkages (schuim of vloeistof) onmiddellijk uit.

GARANTIE

- Deze machine mag alleen binnenshuis worden opgeslagen.
- Maak de stoel waar de veiligheidsdrijver schuift regelmatig schoon en inspecteer deze regelmatig om de integriteit ervan te controleren.
- Gebruik het apparaat niet als het filtersysteem beschadigd is.
- Stofklasse 'M' is niet van toepassing bij het zuigen van vloeistoffen.

VERGEET NIET DAT

- In geval van potentieel gevaarlijke stoffen die in contact komen met de ogen of de huid, spoel ze af met water en raadpleeg een gespecialiseerd centrum.
- In geval van potentieel gevaarlijke stoffen die zijn ingeademd of ingeslikt, moet u een arts raadplegen. Laat u niet overgeven om besmetting van de longen te voorkomen; het wordt aanbevolen om uw mond te spoelen zonder water in te slikken.
- Als er bij spontaan braken potentieel gevaarlijke stoffen in de longen zijn gekomen, vervoer dan naar het ziekenhuis.

De fabrikant wijst alle verantwoordelijkheid af voor oneigenlijk gebruik of het niet opvolgen van de bijgeleverde instructies, voor het knoeien met het apparaat en voor onvoldoende onderhoud.

SYMBOLEN

BESCHRIJVINGSSYMBOLEN INSTRUCTIES



Lees
de instructies
voor het
gebruik van het
apparaat.



De aandacht
wijst op een
potentieel
gevaarlijke
situatie.



Noot:
waarschuwing
voor correct
gebruik



**Bedieningshan-
dleiding**
Gebruiksaanwi-
zjing

SLEUTEL TOT SYMBOLEN



Stopcontact
voor elektrisch
gereedschap



Aansluiting voor
pneumatisch
gereedschap



Nat- &
droogzuiger



“Zelfreinigend
filter” functie



Professioneel





Blower
aansluiting



Industrieel

TECHNISCHE SPECIFICATIES

DV80	
Voedingsspanning	120 V~ 230 V~
Frequentie	50/60 Hz
Machtsclassificatie	120V = 2400 W 230V = 2400 W
Maximale luchtstroom ca.	110 L/sec
Trommel gemaakt van	
Nominale trommelinhoud	80
MAX-zuiging ca.	24 kPa
Motorisoliatieklasse	
Toestel-isoliatieklasse	I ^a
Type motor	Hoogrendementsbypass
Approximatieve appliance-afmetingen	540 x 710 x 950 mm
Verpakkingsgrootte ca.	620 x 660 x 8850 mm
Gewicht van het verpakte apparaat ca.	31 Kg
Gewicht van het apparaat *	25.2 Kg
Constant en gewogen geluidsdruk-niveau	< 69 dB(A)

* Weight in accordance with the procedure EPTA 01/2003

ACCESSOIRES

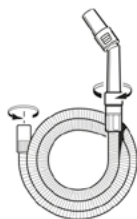

DV-ACC-506

∅45 mm flexibele
slang met
ergonomische
Grip en
downflow-
apparaat

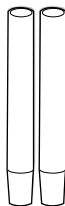

DV-ACC-115

Kunststof
verlengstukken



DV-ACC-104

Spleetmiddel

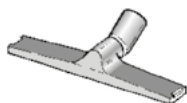

DV-ACC-114

Vloerbeugel-
behuizing voor
gecombineerde
borstel

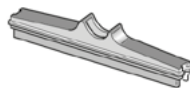

DV-ACC-102

Vloerstaafinzet
voor vloeistoffen

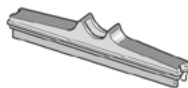

DV-ACC-101

Vloerstaafinzet
voor harde
vloeren

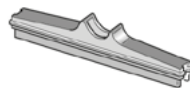

DV-ACC-100

Vloerstaafinzet
voor tapijten



DV-ACC-105

Driehoekig
accessoire



DV-ACC-110

Ronde borstel



DV-ACC-124

Multi-diameter
adapter



DV-ACC-111

Voorfilter



DV-ACC-106

Schuimfilter voor
het zuigen van
vloeistoffen

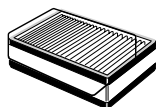

DV-ACC-106

Uitlaatpostfilter
(cellulosevezel +
HEPA)

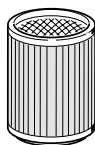

DV-ACC-504

"IFA-
filterpatroon
Klasse 'M'
voor DV 80



DV-ACC-501

"IFA"
dubbellaagse
fleece-filterzak
Klasse "M".
voor DV80

WERKING

DE TRANSPORT HANDLEIDING

Plaats de transporthandgreep (A) op de trommel (B) door deze in de zijzittingen te steken.

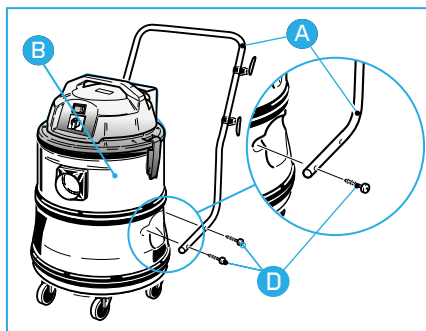

Vergrendelen met de aandraaischroeven (D)

HET VRIJGEVEN VAN DE MOTOREENHEID

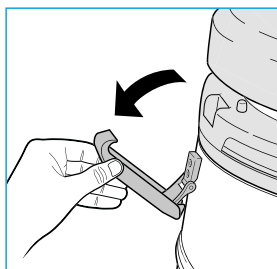
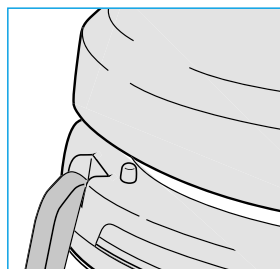

Om de motoreenheid te ontgrendelen.

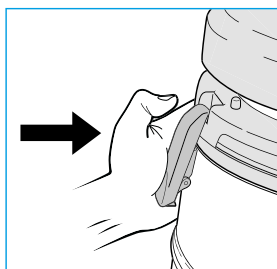
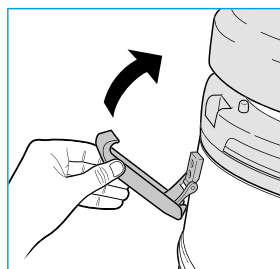

Om de motoreenheid opnieuw te monteren.

OPSLAGHASPEL VOOR HET NETSNOER

Haak (E) positie zoals weergegeven in de figuur.

Om het netsnoer af te rollen, draait u de haken (E).

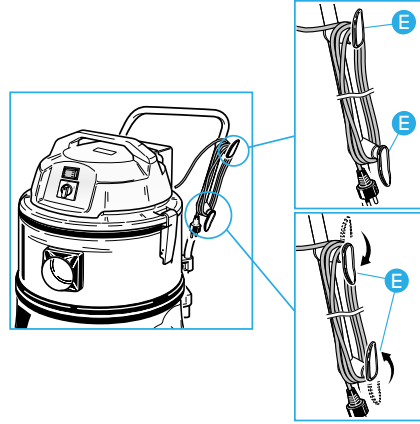

ZWEMMEN

Waarschuwingslicht (A)

Stroomschakelaar (B):
positie "O" - Toestel uit
positie "I" - Toestel op.

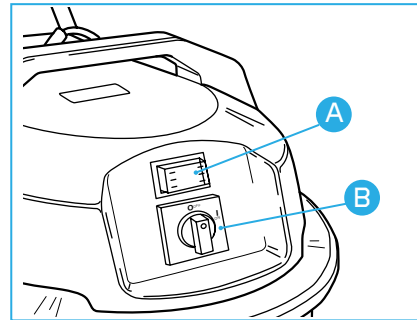

DE FLEXIBELE HOEVEELHEID

Bevestig de aansluiting van de flexibele slang (U) aan de luchtinlaataansluiting (R).

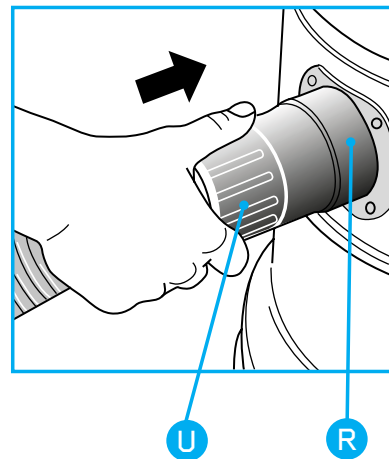

FILTRATIESYSTEMEN

MET BEHULP VAN HET FILTER



Gebruik voor het opzuigen van klasse 'M' stof altijd het filterelement.

Vermijd het gebruik van het filter voor scherpe of vochtige materialen.

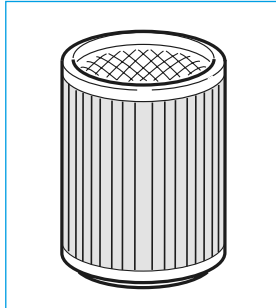

Plaats het filter (B) op het motorhuis (C).

Plaats de plastic schijf (A) op het filter (B).

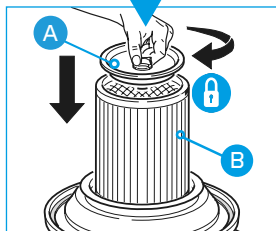
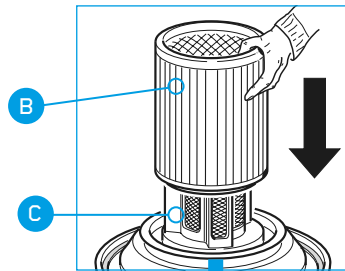

We raden het gebruik van deze filter sterk aan bij het opzuigen van stof en vaste stoffen; deze kan samen met de filterpapierzak worden gebruikt. Dit helpt verstopping van de filterunit te voorkomen en heeft het voordeel dat het gestofzuigd vuil snel en hygiënisch wordt afgevoerd. Vermijd het gebruik ervan voor het snijden of voor vochtige materialen.



Het filterpatroon moet altijd worden gebruikt. Houd het filterpatroon schoon. Vervang het als het te hard is aangekoekt of versleten.

GEBRUIK VAN DE STOFZAK



Gebruik de stofzak alleen als het filterpatroon is geïnstalleerd. Om stof van klasse 'M' op te vangen moet de stofzak in het apparaat worden geïnstalleerd.

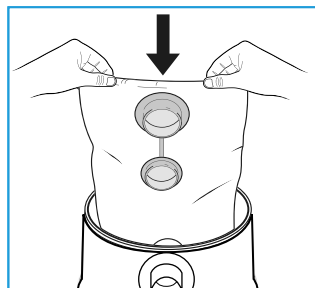

Breng de vezelzak in de afvaltrommel.

Plaats de plastic flens (X) in de luchtinlaatconnector (Y). Let op dat u de zak niet beschadigt.

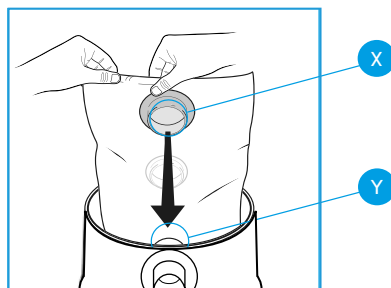

Vervang de zak als het waarschuwingsslampje (B) gaat branden.

HET VERVANGEN VAN DE STOFZAK



De tas mag niet worden hergebruikt en moet altijd worden vervangen.

Gooi de zak weg in overeenstemming met de speciale afvalverwijderingsvoorschriften die in uw land van kracht zijn.

Verwijder de plastic flens (1) van de luchtinlaataansluiting (2). Verwijder de volle zak. Sluit de plastic flens met de meegeleverde dop.

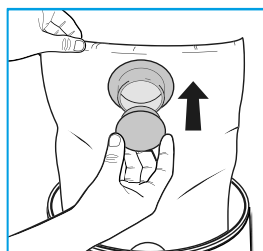
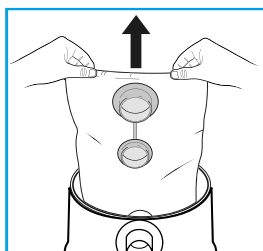
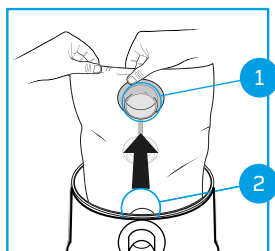



MET BEHULP VAN DE PRE-FILTER (OPTIONEEL)

Gebruik het filterelement om de “prestaties” van de filtratie te verhogen.
Bevestig het voorfilter (P) aan de rand van de mand (G).

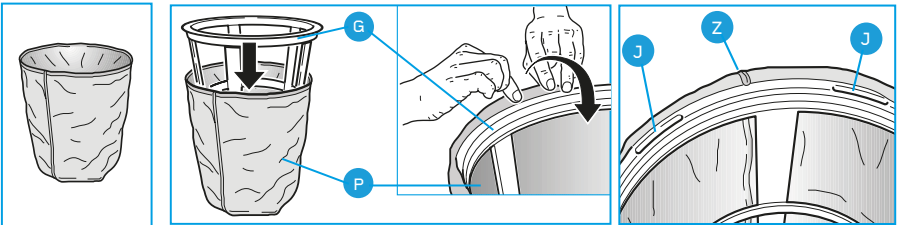

De naad (Z) aan de zijkant van het voorfilter mag de haken (J) op de mand (Z) niet overlappen.

Plaats de ring (F) op de korf (G) en plaats het voorfilter in de trommel.

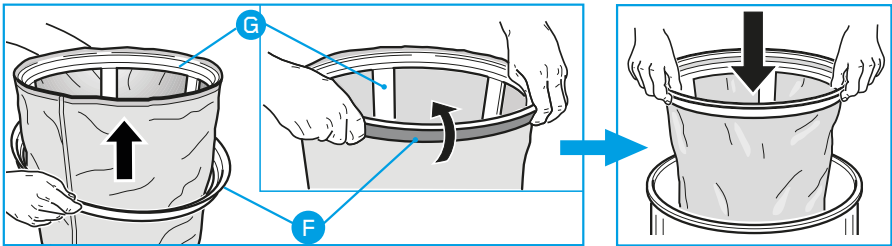

LUCHTUITLAATFILTER

De nafilter garandeert dat de lucht die in het milieu wordt gerecirculeerd, vrij is van onzuiverheden.

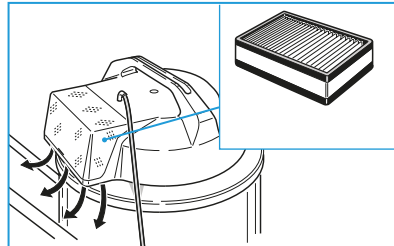

MET BEHULP VAN DE FOAM-FILTER (WET VACUUM)

Om vloeistoffen op te zuigen, gebruikt u **ALTIJD** het schuimfilter.



Het elastiek op het schuimfilter moet over de rand (v) passen.

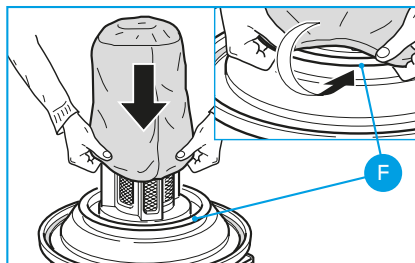

Verwijder altijd het filterpatroon en de papieren filterzak, indien aanwezig. Gebruik het schuimfilter. Het schuimfilter is niet geschikt voor het opzuigen van klasse 'M' stof.

Wanneer de opgezogen vloeistoffen het maximale niveau in de trommel bereiken, wordt de afzuiging automatisch afgesneden door de veiligheidsvlotter. De gebruiker wordt gewaarschuwd door een verhoging van het toerental van de motor en het gebrek aan zuiging. Schakel het apparaat onmiddellijk uit en maak de trommel leeg.

HET OPZUGEN VAN GROTE HOEVEELHEDEN VLOEISTOF

Om een gedeeltelijke luchtstroom te garanderen, moet u ervoor zorgen dat het spleetgereedschap nooit volledig ondergedompeld is.

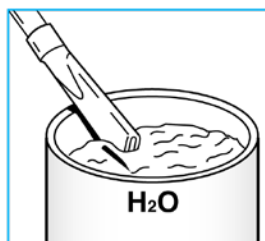

HET SCHOONMAKEN VAN HET SCHUIM FILTER

Spoel het schuimfilter af met water. Gebruik **GEEN** reinigingsmiddel. Vervang het filter als het versleten of gescheurd is.

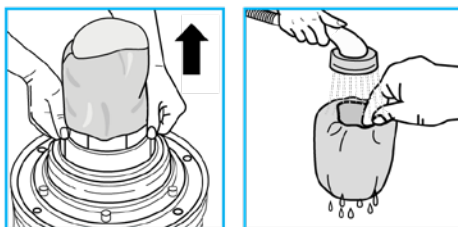

PROPER GEBRUIK



De ontladingskraan (k) moet worden gesloten om te voorkomen dat het opgezogen materiaal ontsnapt.

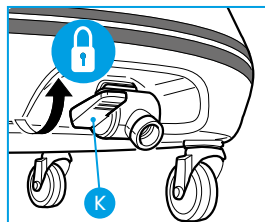

MET BEHULP VAN DE BLAASFUNCTIE



De blowerfunctie kan alleen worden gebruikt als er geen poeders van de categorie 'L' en 'M' aanwezig zijn.

Verwijder het reservoir (P) met het HEPA-uitlaatfilter.

Bevestig de flexibele slangkoppeling (U) aan de uitlaatkoppeling (r) en draai deze met de wijzers van de klok mee.

Zet het apparaat aan. (Zie bladzijde 58)

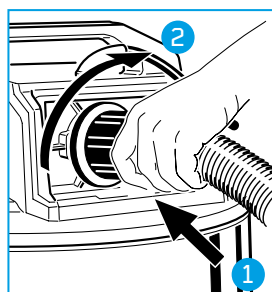
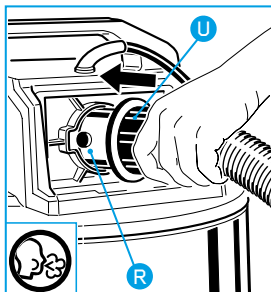
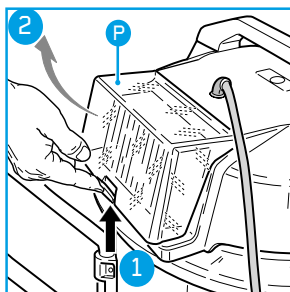

ONDERHOUD



Haal altijd de stekker van het apparaat uit het stopcontact voordat u het filtersysteem op enigerlei wijze reinigt of onderhoudt.

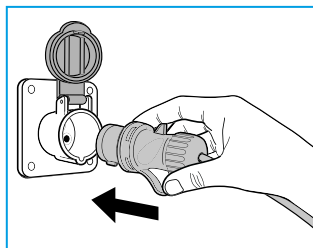

HET REINIGEN VAN HET FILTERPATROON

Verwijder het filter van de motorsteun.

Reinig het filterpatroon regelmatig met een zachte borstel.

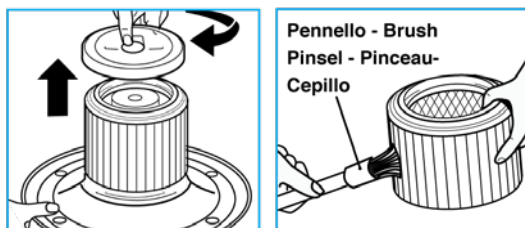

Was het filterpatroon **NOOIT** met water en/of andere vloeistoffen.

REINIGING VAN HET VOORFILTER

Om de voorfilterkorf schoon te maken, schud je hem in de vuilnisbak.
Blaas er indien nodig op.
Vervang hem als hij versleten is.

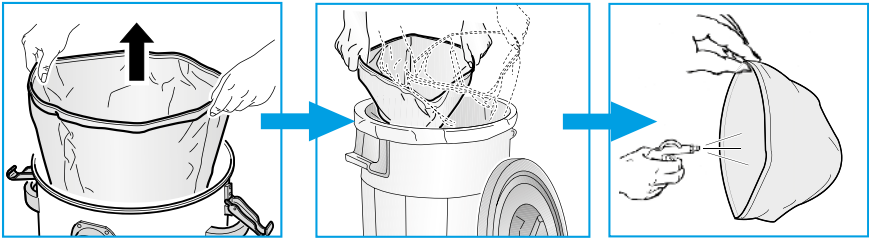

Was de voorfilter van de bus NOOIT met water en/of andere vloeistoffen.

HET REINIGEN VAN HET UITLAATFILTER

Vervang het post-filter regelmatig:

Maak het reservoir (P) los, verwijder het uitlaatfilter; Plaats het nieuwe uitlaatfilter zo dat de afdichting (O) naar de buitenkant van het reservoir (P) is gericht; Sluit het reservoir (P).

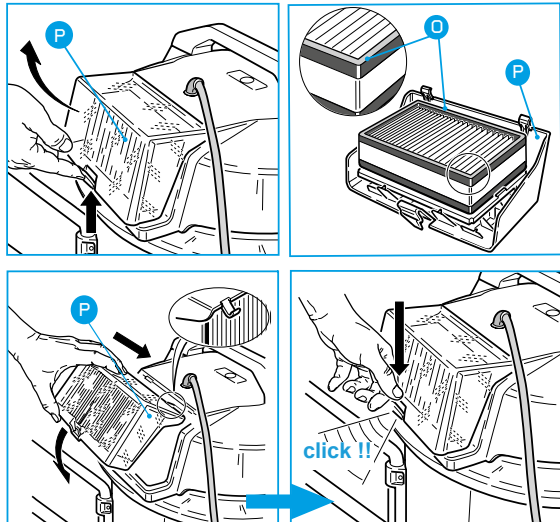

HET SCHOONMAKEN VAN DE TROMMEL

Maak na het zuigen van vloeistoffen de trommel leeg en spoel deze samen met de accessoires om kalkaanslag te voorkomen.

Om de trommelcontainer te legen na het opzuigen van vloeistof stoffen openen de aftapkraan (K) met de motor UIT.

Was de zitting regelmatig op de plaats waar de veiligheidsvlotter glijdt om de goede werking ervan te garanderen.

Voordat u weer stof van klasse 'M' gaat opzuigen, moet u ervoor zorgen dat het filterelement en de zak gemonteerd zijn.

Was de trommel na elk gebruik.

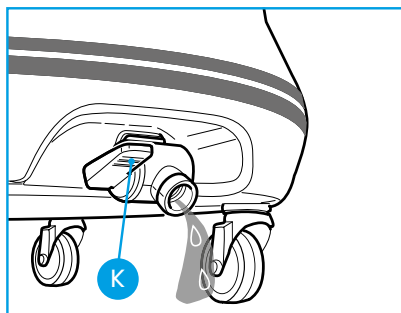



HET OPLOSSEN VAN PROBLEMEN

Problemen	Oorzaken	Oplossingen
Het apparaat zal niet beginnen	Geen stroom. Defecte stroomkabel, schakelaars of motor.	Controleer of het stopcontact werkt Neem contact op met uw technische dienst (zie bijgevoegde lijst).
Verminderde Efficiëntie	Trommel te vol Filterpatroon is vuil of aangekoekt. Verstopte buis of accessoires.	Lege trommel Maak het filter grondig schoon of vervang het, Controleer de slang of de accessoires.
Het toerental van de motor is merkbaar hoger.	Trommel is te vol. Filterpatroon is vuil of aangekoekt. Verstopte buis of accessoires. Aftapkraan (K) open	Controleer de trommel. Reinig of vervang het filter grondig, Controleer de slang of de accessoires. Sluit de aftapkraan (K)
Het stof gaat uit de uitlaat post-filter.	Hoofdfilter is beschadigd of gescheurd.	Controleer het filter en vervang het indien nodig.

Gooi elektrische apparaten niet weg met huishoudelijk afval!

In overeenstemming met de Europese Richtlijn 2012/19/EU betreffende afgedankte elektrische en elektronische apparatuur (AEEA) en de uitvoering daarvan in overeenstemming met de nationale wetgeving, moeten elektrische gereedschappen die het einde van hun levenscyclus hebben bereikt, gescheiden worden ingezameld en worden ingeleverd bij een milieuvriendelijke recyclinginrichting.

“EC-VERKLARING VAN OVEREENSTEMMING”

De fabrikant verklaart dat de in deze handleiding beschreven producten

DV80 MBN

Voldoen aan de essentiële vereisten van de Europese richtlijnen:

2014/35 / EU

2014/30 EU

2011/65 / EU

en is in overeenstemming met de normen

EN 60335-1: 2012 + A11: 2014

EN 60335-2-69:2012

EN 62233: 2008

EN 55014-1: 2006 + A1: 2009 + A2: 2011

EN 55014-2: 2015

EN 61000-3-2: 2014

EN 61000-3-3: 2014

Deze verklaring is opgesteld in oktober 2016.



FRANÇAIS

INSTRUCTION MANUAL

AVERTISSEMENTS	70
DESCRIPTION SYMBOLES INSTRUCTIONS	75
CLÉ DES SYMBOLES	75
LES SPÉCIFICATIONS TECHNIQUES	76
ACCESSOIRES	77
FONCTIONNEMENT	79
SYSTÈMES DE FILTRAGE	81
UTILISATION CORRECTE	85
MAINTENANCE	86
DÉPANNAGE	89
DÉCLARATION DE CONFORMITÉ DE L'UE	90

AVERTISSEMENTS



Les appareils décrits dans ce manuel sont adaptés :

- Aspiration de la poussière et des liquides.
- Usage professionnel (par exemple, hôtels, écoles, hôpitaux, usines, magasins, bureaux et agences de location).
- La catégorie “M” convient à la séparation des poudres sèches (à condition qu’elles ne soient pas explosives, inflammables et/ou cancérigènes) avec une perméabilité maximale <math><0,1\%</math> et une CMA (concentration maximale admissible) $\geq 0.1\text{mg/m}^3$

Conservez soigneusement ce manuel d’instructions.

- Un appareil électrique n’est pas un jouet. Utilisez-le et rangez-le hors de portée des enfants. Les enfants doivent être surveillés pour s’assurer qu’ils ne jouent pas avec l’appareil.
- Gardez les éléments de l’emballage (boîte en carton, protections PSE, etc.) hors de la portée des enfants.
- Cet appareil n’a pas été conçu pour être utilisé par des personnes (y compris des enfants) dont les facultés physiques, sensorielles et mentales sont réduites, ou qui n’ont pas lu le présent mode d’emploi au préalable.
- Cet appareil a été conçu pour fonctionner uniquement en courant alternatif. Avant de mettre l’appareil en marche, vérifiez que la tension du réseau correspond à celle indiquée sur la plaque signalétique.

- Vérifiez que le système électrique est équipé d'un interrupteur différentiel (type coupe-circuit automatique)
- N'utilisez une rallonge que si elle est en parfait état et assurez-vous que sa section est adaptée à la puissance de l'appareil plus celle de l'outil électrique.
- Ne laissez jamais l'appareil en marche sans surveillance.
- Si l'air de décharge est rejeté dans l'environnement de travail, il doit avoir un indice d'échange d'air de classe "M" suffisant. Afin de respecter les valeurs limites requises, le débit doit être au maximum de 50 % du débit d'air frais (volume de l'environnement VR par indice de renouvellement d'air LW). Respectez également les réglementations en vigueur.
- Déroulez complètement le câble d'alimentation avant de mettre l'appareil en marche.
- Ne dirigez pas le tuyau d'aspiration vers les oreilles, les yeux, les cheveux, les personnes ou les animaux en général.
- Pendant le transport de l'appareil, le moteur doit être arrêté. Veillez également à ce que l'appareil ne puisse pas disperser la poussière dans l'environnement et qu'il soit en position stable
- Arrêtez la machine en cas de forte émission de poussière, d'incendie ou de fumée. L'utilisation de l'appareil n'est autorisée qu'après vérification et réparation par une personne autorisée.
- Débranchez toujours la fiche de la prise de courant immédiatement après l'utilisation et avant d'effectuer tout nettoyage ou entretien de l'appareil.
- Nettoyez le lieu où l'entretien est effectué afin d'éviter que des substances dangereuses ne soient dispersées dans l'environnement.

Risque de chute :

Ne montez pas sur le couvercle de l'appareil et ne vous asseyez pas dessus.



WARNINGS

- Les réparations ne peuvent être effectuées que par des spécialistes qui conservent les pièces de rechange originales fournies par le fabricant.
Il peut être extrêmement dangereux de réparer l'appareil soi-même.
- Conformément à la réglementation en vigueur, les appareils qui doivent être mis au rebut doivent être rendus inutilisables en coupant le câble d'alimentation avant leur élimination.
- L'appareil doit être décontaminé par des méthodes de nettoyage par aspiration et être essuyé ou traité avec un produit d'étanchéité avant d'être sorti d'une zone dangereuse. Toutes les autres parties de l'appareil doivent être considérées comme contaminées lorsqu'elles sont retirées de la zone dangereuse et des mesures appropriées doivent être prises pour empêcher la dispersion de la poussière.
- Lors du nettoyage et de l'entretien, il est recommandé de toujours porter des dispositifs de protection individuelle (gants et masque), comme l'exigent les réglementations nationales en vigueur.

N'utilisez jamais l'appareil :

- Lorsque vos mains sont humides ou mouillées ;
- Si elle est tombée et présente des dommages ou des dysfonctionnements évidents ;
- Si le câble d'alimentation ou la prise est défectueux.

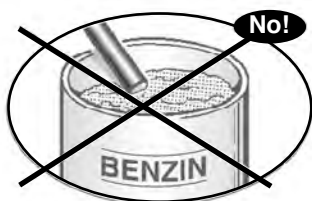

Nettoyez l'appareil en utilisant uniquement de l'eau. N'utilisez pas de trichloréthylène, de solvants ou de détergents abrasifs.

- Avant de procéder aux opérations d’entretien, il est fortement recommandé de décontaminer d’abord l’appareil en aspirant de l’air propre pendant quelques minutes et de le nettoyer à l’extérieur.
- L’entretien et le nettoyage doivent être effectués dans un local suffisamment ventilé et de manière à ne pas mettre en danger les opérateurs ou d’autres personnes.
- Lors des opérations d’entretien, de réparation et d’élimination, toutes les parties contaminées de l’appareil qui ne peuvent être complètement nettoyées doivent être éliminées ; elles doivent être placées dans des sacs imperméables conformément aux réglementations nationales en vigueur pour l’élimination des déchets spéciaux.
- Pour une élimination correcte, il est conseillé d’indiquer sur le sac imperméable les substances qui ont été aspirées.
- Il est recommandé d’effectuer une inspection technique de l’appareil au moins une fois par an pour vérifier l’étanchéité des joints et le bon fonctionnement des mécanismes de contrôle afin de pouvoir détecter d’éventuels dysfonctionnements. Vérifier quotidiennement l’intégrité du système de filtrage.
- Cet appareil a été conçu pour être utilisé par des personnes dûment formées, notamment en ce qui concerne le nettoyage et l’entretien de l’appareil, les risques liés aux matériaux aspirés et leur élimination correcte, et le remplacement des pièces de rechange conformément aux directives en vigueur dans les différents pays.
- N’aspirez pas les substances inflammables, potentiellement explosives ou corrosives et les cendres incandescentes. Ces substances peuvent compromettre la sécurité et le fonctionnement de l’appareil.



Si le câble d’alimentation est endommagé, il doit être remplacé par le fabricant ou le centre de service technique agréé ou en tout cas par une personne ayant une qualification similaire afin de prévenir tout risque.



Ne posez jamais le câble d'alimentation sur des bords tranchants, ne l'écrasez pas et tenez-le éloigné des brosses électriques rotatives

N'utilisez la prise de courant (lorsqu'elle est installée) de l'appareil que pour les usages spécifiés dans le mode d'emploi.

En cas de fuite (mousse ou liquide), éteignez immédiatement l'appareil.

SURETY

- Cette machine ne doit être stockée qu'à l'intérieur.
- Nettoyez fréquemment le siège où coulisse le flotteur de sécurité et inspectez-le périodiquement pour vérifier son intégrité.
- N'utilisez pas l'appareil lorsque le système de filtrage est endommagé.
- La classe de poussière "M" ne s'applique pas à l'aspiration de liquides.

RAPPELEZ-VOUS QUE

- En cas de contact des substances potentiellement dangereuses avec les yeux ou la peau, rincez-les à l'eau et consultez un centre spécialisé.
- En cas d'inhalation ou d'ingestion de substances potentiellement dangereuses, appelez un médecin. Ne provoquez pas de vomissements pour éviter de contaminer les poumons ; il est recommandé de se rincer la bouche sans avaler d'eau.
- Si, en cas de vomissement spontané, est censé avoir pénétré dans les poumons de substances potentiellement dangereuses, transporter à l'hôpital.

Le fabricant décline toute responsabilité en cas d'utilisation inappropriée ou non conforme aux instructions fournies, d'altération et d'entretien insuffisant de l'appareil.

SYMBOLES

DESCRIPTION SYMBOLES INSTRUCTIONS



Lire
les instructions
avant d'utiliser
l'appareil.



L'attention
indique une
situation
potentiellement
dangereuse.



Note
avertissement
pour une
utilisation
correcte



**Manuel
d'utilisation**
Mode d'emploi

LA CLÉ DES SYMBOLES



Prise de courant
pour outils
électriques



Connexion
pour les outils
pneumatiques



Aspirateur à eau
et à sec



"Fonction
"Filtre auto-
nettoyant



Professionnel



Raccordement
de la soufflerie





Industrie



LES SPÉCIFICATIONS TECHNIQUES

DV80

Tension d'alimentation	120 V~ 230 V~
Fréquence	50/60 Hz
Puissance nominale	120V = 2400 W 230V = 2400 W
Débit d'air maximum environ	110 L/sec
Tambour en	
Capacité nominale du tambour	80
Aspiration MAX environ	24 kPa
Classe d'isolation des moteurs	
Classe d'isolation des appareils	I ^a
Type de moteur	Dérivation à haute efficacité
Dimensions approximatives de l'application	540 x 710 x 950 mm
Taille de l'emballage environ	620 x 660 x 8850 mm
Poids de l'appareil emballé environ	31 Kg
Poids de l'appareil *	25.2 Kg
Niveau de pression acoustique constant et pondéré	< 69 dB(A)

* Weight in accordance with the procedure EPTA 01/2003

ACCESSOIRES

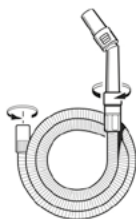

DV-ACC-506

Tuyau flexible de $\varnothing 45$ mm avec dispositif ergonomique dispositif de préhension et de descente

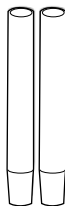

DV-ACC-115

Baguettes de rallonge en plastique



DV-ACC-104

Outil de crevasse

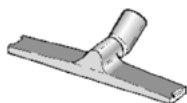

DV-ACC-114

Boîtier de la barre de sol pour brosse combinée

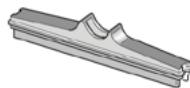

DV-ACC-102

Insert de barre de sol pour les liquides

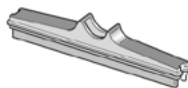

DV-ACC-101

Insert de barre de sol pour les sols durs

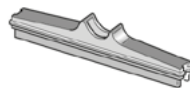

DV-ACC-100

Insertion de barres de sol pour les tapis



DV-ACC-105

Accessoire
triangulaire



DV-ACC-110

Brosse ronde.



DV-ACC-124

Adaptateur
multi-diamètre



DV-ACC-111

Pré-filtre



DV-ACC-106

Filtre à mousse
pour l'aspiration
des liquides



DV-ACC-106

Filtre de poste
d'échappement
(fibre de
cellulose + HEPA)

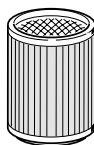

DV-ACC-504

"Cartouche
filtrante "IFA"
Classe "M"
pour DV 80



DV-ACC-501

Sac filtrant en
tissu polaire
double couche
"IFA" Classe "M"
pour DV80

OPÉRATION

L'ATTACHEMENT DE LA MANUTENTION DE TRANSPORT

Montez la poignée de transport (A) sur le tambour (B) en l'insérant dans les sièges latéraux.

Verrouillez avec les vis de serrage (D)

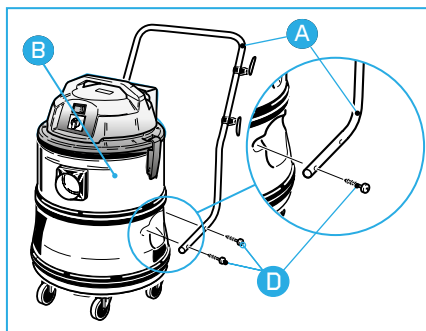

DÉBLOCAGE DE L'UNITÉ MOTRICE

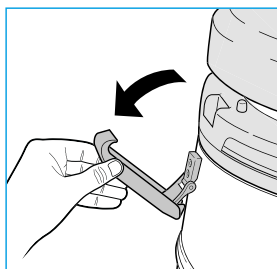
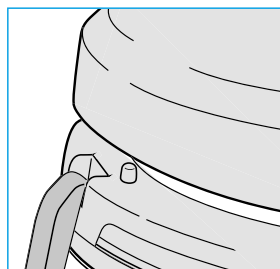

Pour libérer l'unité motrice.

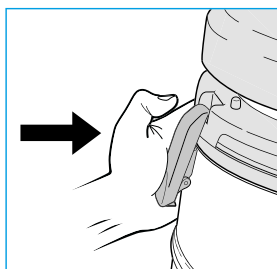
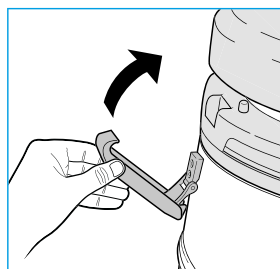

Pour remettre en état le groupe moteur.

BOBINE DE STOCKAGE DU CORDON D'ALIMENTATION

Position du crochet (E) comme indiqué dans la figure.

Pour dérouler le cordon d'alimentation, tournez les crochets (E).

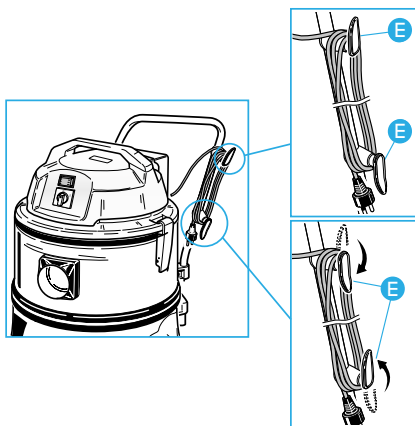

MISE EN MARCHE

Témoin lumineux (A)

Interrupteur d'alimentation (B) :
position "O" - Appareil éteint
position "I" - Appliance on.

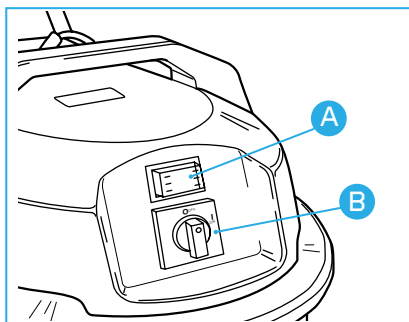

S'ATTACHER AU TUYAU FLEXIBLE

Raccordez le connecteur du tuyau flexible (U) au connecteur d'entrée d'air (R).

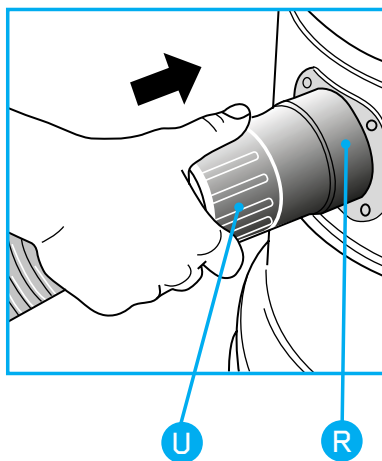

SYSTÈMES DE FILTRAGE

L'UTILISATION DU FILTRE



Pour aspirer la poussière de classe "M", utilisez toujours l'élément filtrant.
Évitez d'utiliser le filtre pour les matériaux pointus ou humides .

Placez le filtre (B) sur le boîtier du moteur (C).

Montez le disque en plastique (A) sur le filtre (B)



Nous recommandons fortement d'utiliser ce filtre pour aspirer la poussière et les solides ; il peut être utilisé avec le sac en papier filtrant. Cela permet d'éviter le colmatage de l'unité de filtrage et présente l'avantage de rendre l'élimination des débris aspirés rapide et hygiénique.

Évitez de les utiliser pour couper ou humidifier des matériaux.

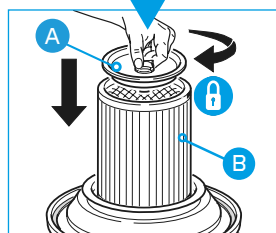
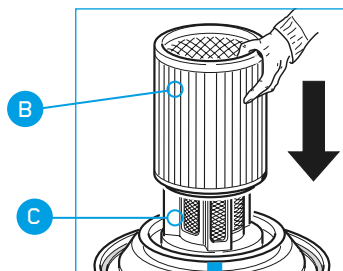
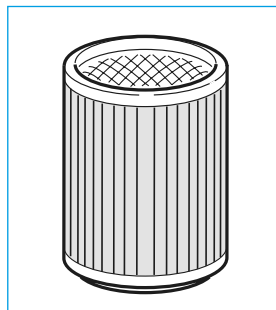

La cartouche filtrante doit toujours être utilisée. Gardez la cartouche filtrante propre. Remplacez-la si elle est trop encrassée ou usée.

L'UTILISATION DU SAC À POUSSIÈRE



N'utilisez le sac à poussière que lorsque la cartouche filtrante est installée. Pour ramasser la poussière de classe "M", le sac à poussière doit être installé dans l'appareil.

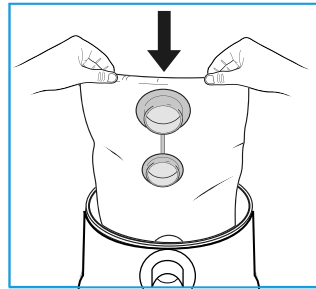

Introduisez le sac en fibre dans le fût à déchets.

Introduisez la bride en plastique (X) dans le raccord d'entrée d'air (Y). Faites attention à ne pas endommager le sac.

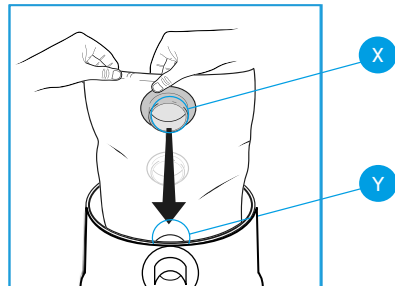

Changez le sac lorsque le témoin lumineux (B) s'allume.

CHANGER LE SAC À POUSSIÈRE



Le sac ne doit pas être réutilisé et doit toujours être changé.

Éliminez le sac conformément à la réglementation spéciale sur l'élimination des déchets en vigueur dans votre pays

Retirez la bride en plastique (1) du raccord d'entrée d'air (2) et sortez le sac plein. Fermez la bride en plastique avec le bouchon fourni.

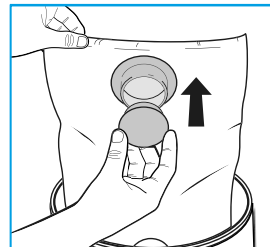
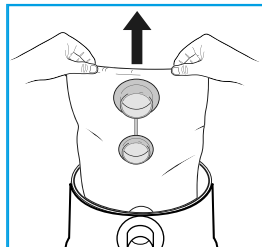
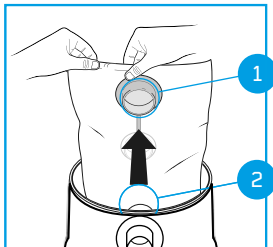



EN UTILISANT LE PRÉ-FILTRE (FACULTATIF)

Utiliser l'élément filtrant pour augmenter la "performance" de la filtration
Fixer le préfiltre (P) au bord du panier (G)

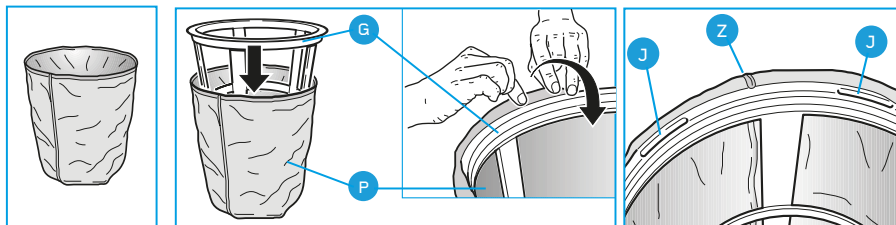

La couture (Z) sur le côté du préfiltre ne doit pas chevaucher les crochets (J) du panier (G).

Montez l'anneau (F) sur le panier (G) et insérez l'ensemble du pré-filtre dans le tambour.

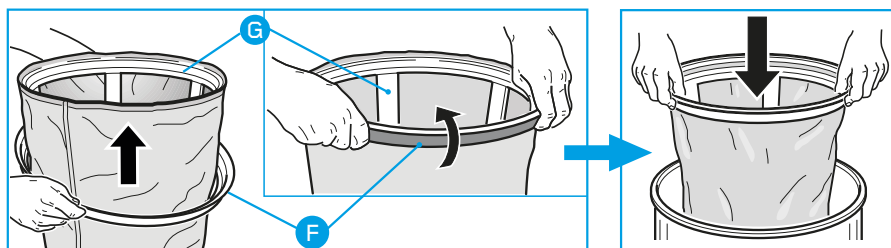

POST-FILTRE DE SORTIE D'AIR

Le post-filtre garantit que l'air recirculé dans l'environnement est exempt d'impuretés.

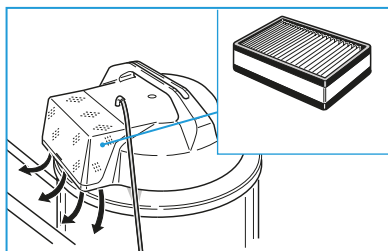

EN UTILISANT LE FILTRE FOAM (WET VACUUM)

Pour aspirer les liquides, utilisez TOUJOURS le filtre en mousse.



L'élastique du filtre en mousse doit passer par-dessus le bord (V).

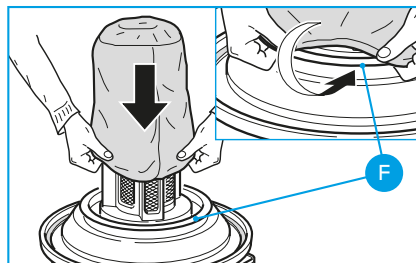

Retirez toujours la cartouche filtrante et le sachet filtrant en papier, le cas échéant. Utilisez le filtre en mousse. Le filtre en mousse n'est pas adapté pour aspirer la poussière de classe "M".

Lorsque les liquides aspirés atteignent le niveau maximum à l'intérieur du fût, l'aspiration est automatiquement coupée par le flotteur de sécurité. L'utilisateur est alerté par une augmentation du régime du moteur et par l'absence d'aspiration. Éteignez immédiatement l'appareil et videz le fût.

L'ASPIRATION DE GRANDES QUANTITÉS DE LIQUIDE

Pour assurer un flux d'air partiel, veillez à ce que l'outil de crevasse ne soit jamais complètement submergé.

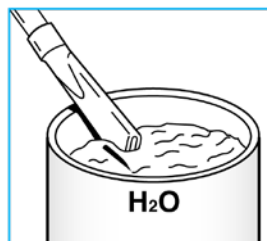

NETTOYER LA MOUSSE FILTRE

Rincez le filtre en mousse avec de l'eau. N'utilisez pas de détergent. Remplacez-le s'il est usé ou déchiré.

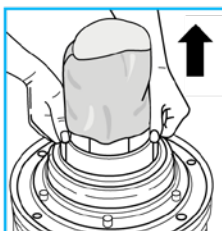

UTILISATION APPROPRIÉE



Le robinet de décharge (k) doit être fermé pour éviter que la matière aspirée ne s'échappe.

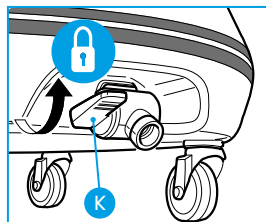

UTILISER LA FONCTION DE SOUFFLERIE



La fonction de soufflerie ne peut être utilisée qu'en l'absence de poudres de catégorie "L" et "M".

Retirez le récipient (P) avec le filtre d'évacuation HEPA

Fixez le connecteur du tuyau flexible (U) au connecteur d'échappement (r) et tournez-le dans le sens des aiguilles d'une montre.

Allumez l'appareil. (Voir page 80)

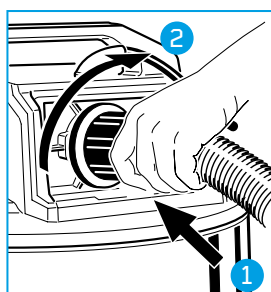
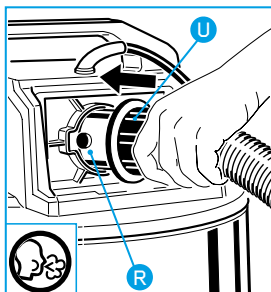
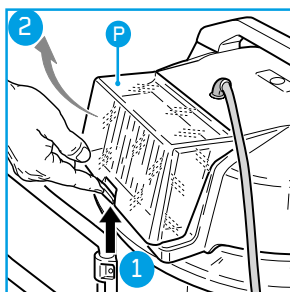

MAINTENANCE



Débranchez toujours l'appareil de l'alimentation électrique avant de nettoyer ou d'entretenir le système de filtrage de quelque manière que ce soit.

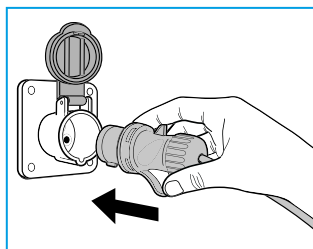

LE NETTOYAGE DE LA CARTOUCHE FILTRANTE

Retirez le filtre du support du moteur.

Nettoyez fréquemment la cartouche filtrante avec une brosse à poils doux.

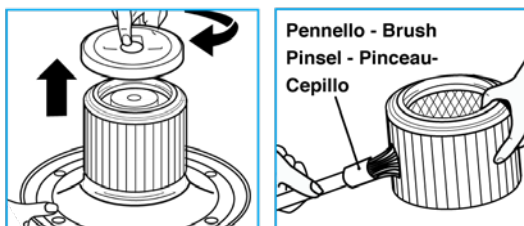

NE JAMAIS laver la cartouche filtrante avec de l'eau et/ou d'autres liquides.

LE NETTOYAGE DU FILTRE DU PRÉ-FILTRE

Pour nettoyer le panier du préfiltre, secouez-le dans la poubelle.
Soufflez dessus si nécessaire.
Remplacez-le s'il est usé.

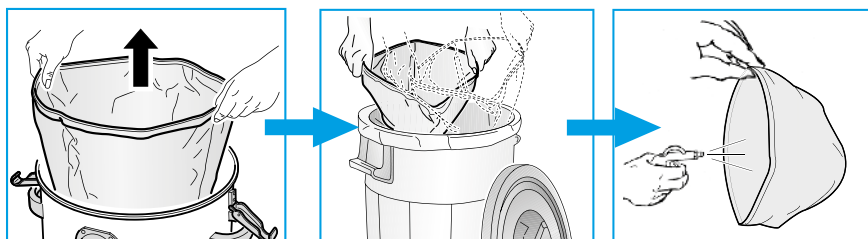

NE JAMAIS laver le pré-filtre de la cartouche avec de l'eau et/ou d'autres liquides.

LE NETTOYAGE DU FILTRE D'ÉCHAPPEMENT

Remplacez le post-filtre périodiquement :

Relâchez le récipient (P), retirez le filtre d'échappement ;
Positionnez le nouveau filtre d'échappement de sorte que le joint (O) soit tourné vers l'extérieur du récipient (P) ;
fermer le récipient (P).

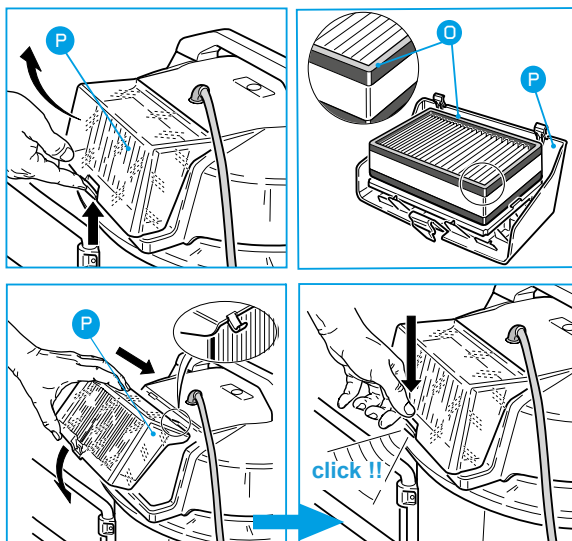

LE NETTOYAGE DU TAMBOUR

Après avoir aspiré les liquides, videz le fût et rincez-le avec les accessoires afin d'éviter la formation de tartre.

Pour vider le conteneur-fût après avoir aspiré le liquide substances ouvrent le robinet de vidange (**K**) avec le moteur arrêté.

Laver fréquemment le siège où coulisse le flotteur de sécurité afin de s'assurer de son bon fonctionnement.

Avant d'aspirer à nouveau la poussière de classe "M", assurez-vous que l'élément filtrant et le sac sont bien en place.

Lavez le tambour après chaque utilisation.

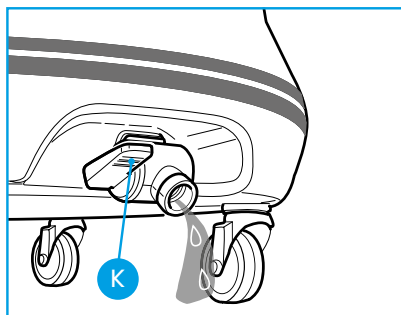



DÉPANNAGE

Problèmes	Causes	Solutions
L'appareil ne pas commencer	Pas de pouvoir Cordon d'alimentation, interrupteurs ou moteur défectueux.	Vérifiez que la prise de courant fonctionne Contactez votre centre de service technique (voir liste ci-jointe).
Réduit Efficacité	Tambour trop plein La cartouche du filtre est sale ou encrassée. Tube ou accessoires bouchés.	Tambour vide Nettoyez soigneusement ou changez le filtre, Vérifiez le tuyau ou les accessoires.
Le régime du moteur est sensiblement plus élevé.	Tambour trop plein. La cartouche filtrante est sale ou encrassée. Tube ou accessoires bouchés. Le robinet de vidange (K) est ouvert.	Vérifiez le tambour. Nettoyez soigneusement ou changez le filtre, Vérifiez le tuyau ou les accessoires. Fermez le robinet de vidange (K)
La poussière sort de l'échappement post-filtre.	Le filtre principal est endommagé ou déchiré.	Vérifiez le filtre et remplacez-le si nécessaire.



Ne pas éliminer les appareils électriques avec les déchets ménagers !

Conformément à la directive européenne 2012/19/UE relative aux déchets d'équipements électriques et électroniques (DEEE) et à sa mise en œuvre selon la législation nationale, les outils électriques qui ont atteint la fin de leur cycle de vie doivent être collectés séparément et renvoyés à une installation de recyclage compatible avec l'environnement.

DÉCLARATION "EC" DE CONFORMITÉ".

Le fabricant déclare que les produits décrits dans ces
instructions

DV80 MBN

Respecter les exigences essentielles des directives européennes :

2014/35 / EU

2014/30 EU

2011/65 / EU

et est conforme aux normes

EN 60335-1: 2012 + A11: 2014

EN 60335-2-69:2012

EN 62233: 2008

EN 55014-1: 2006 + A1: 2009 + A2: 2011

EN 55014-2: 2015

EN 61000-3-2: 2014

EN 61000-3-3: 2014

Cette déclaration a été rédigée en octobre 2016.



ITALIANO

ISTRUZIONI MANUALE

AVVERTENZE	92
DESCRIZIONE SIMBOLI ISTRUZIONI	97
CHIAVE AI SIMBOLI	97
SPECIFICHE TECNICHE	98
ACCESSORI	99
FUNZIONAMENTO	101
SISTEMI FILTRO	103
USO CORRETTO	107
MANUTENZIONE	108
RISOLUZIONE DEI PROBLEMI	111
DICHIARAZIONE DI CONFORMITÀ UE	112

AVVERTENZE



Gli apparecchi descritti in questo manuale sono adatti:

- Aspirare polvere e liquidi.
- Uso professionale (ad es. alberghi, scuole, ospedali, fabbriche, negozi, uffici e agenzie di noleggio).
- La categoria “M” è adatta per la separazione di polveri secche (purché non esplosive, infiammabili e/o cancerogene) con permeabilità massima $<0,1\%$ e MAC (concentrazione massima consentita) $\geq 0,1 \text{ mg/m}^3$.

Conservare con cura questo manuale di istruzioni.

- Un apparecchio elettrico non è un giocattolo. Usatelo e conservatelo fuori dalla portata dei bambini. I bambini devono essere sorvegliati per assicurarsi che non giochino con l'apparecchio.
- Tenere i componenti dell'imballaggio (scatola di cartone, protezioni PSE, ecc.) fuori dalla portata dei bambini.
- Questo apparecchio non è stato progettato per essere utilizzato da persone (compresi i bambini) con ridotte capacità fisiche, sensoriali e mentali o che non hanno letto le presenti istruzioni per l'uso.
- Questo apparecchio è stato progettato per funzionare solo con corrente alternata. Prima di mettere in funzione l'apparecchio, verificare che la tensione di rete corrisponda a quella indicata sulla targhetta dati.



- Verificare che l'impianto elettrico sia dotato di un interruttore differenziale (tipo spegnimento automatico)
- Utilizzare un cavo di prolunga solo se in perfette condizioni e assicurarsi che la sezione sia adeguata alla potenza dell'apparecchio più la potenza dell'utensile elettrico.
- Non lasciare mai l'apparecchio in funzione incustodito.
- Se l'aria di scarico viene rilasciata nuovamente nell'ambiente di lavoro, deve avere un indice di ricambio dell'aria di classe "M" sufficiente. Per rispettare i valori limite richiesti, la portata deve essere al massimo il 50% della portata d'aria fresca (volume dell'ambiente VR per indice di ricambio d'aria LW). Rispettare anche le normative vigenti.
- Srotolare completamente il cavo di alimentazione prima di avviare l'apparecchio.
- Non puntare il tubo di aspirazione su orecchie, occhi, capelli, persone o animali in generale.
- Durante il trasporto dell'apparecchio, il motore deve essere spento. Assicurarsi inoltre che l'apparecchio non possa disperdere la polvere nell'ambiente e che si trovi in una posizione stabile
- Spegnerne la macchina in caso di elevata emissione di polvere, incendio o fumo. L'uso dell'apparecchio è consentito solo dopo che è stato controllato e riparato da una persona autorizzata.
- Staccare sempre la spina dalla presa di corrente immediatamente dopo l'uso e prima di effettuare qualsiasi pulizia o manutenzione sull'apparecchio.

Rischio di caduta:

Non salire o sedersi sul coperchio dell'apparecchio.



AVVERTENZE

- Le riparazioni possono essere effettuate solo da specialisti che conservano i pezzi di ricambio originali forniti dal produttore.
La riparazione dell'apparecchio da soli può essere estremamente pericolosa.
- In conformità alle norme vigenti, gli apparecchi da smaltire devono essere resi inutilizzabili tagliando il cavo di alimentazione prima dello smaltimento.
- L'apparecchio deve essere decontaminato con metodi di pulizia con l'aspirapolvere e pulito o trattato con sigillante prima di essere portato fuori da una zona pericolosa. Tutte le altre parti dell'apparecchio devono essere considerate contaminate quando vengono rimosse dall'area pericolosa e devono essere prese misure appropriate per prevenire la dispersione della polvere.
- Durante la pulizia e la manutenzione, si raccomanda di indossare sempre dispositivi di protezione personale (guanti e mascherina) come richiesto dalle normative nazionali vigenti.
- Prima di procedere con le operazioni di manutenzione, si raccomanda vivamente di decontaminare l'apparecchio prima di procedere con le operazioni di manutenzione, aspirando aria pulita per alcuni minuti e di pulirlo all'esterno.

Non utilizzare mai l'apparecchio:

- Quando le mani sono bagnate o umide;
- Se è caduto e mostra evidenti danni o malfunzionamenti;
- Se il cavo di alimentazione o la spina sono difettosi.



**Pulire l'apparecchio solo con acqua.
Non utilizzare tricloroetilene,
o detergenti abrasivi.**



-
- La manutenzione e la pulizia devono essere effettuate in un locale con adeguata ventilazione e in modo da non mettere in pericolo gli operatori o altre persone.
 - Pulire il luogo in cui si effettua la manutenzione per evitare che le sostanze pericolose si disperdano nell'ambiente.
 - Durante le operazioni di manutenzione, riparazione e smaltimento, tutte le parti contaminate dell'apparecchio che non possono essere completamente pulite devono essere eliminate; metterle in sacchetti impermeabili secondo le norme nazionali vigenti per lo smaltimento dei rifiuti speciali.
 - Per un corretto smaltimento è consigliabile indicare sul sacco impermeabile quali sostanze sono state aspirate.
 - Si raccomanda di effettuare un controllo tecnico sull'apparecchio almeno una volta all'anno per verificare la tenuta dei sigilli e il corretto funzionamento dei meccanismi di controllo in modo da poter rilevare eventuali malfunzionamenti. Controllare giornalmente l'integrità del sistema di filtraggio.
 - Questo apparecchio è stato progettato per essere utilizzato da persone adeguatamente addestrate, in particolare per la pulizia e la manutenzione dell'apparecchio, i rischi derivanti dai materiali aspirati e il loro corretto smaltimento e la sostituzione dei pezzi di ricambio secondo le direttive vigenti nei vari paesi.
 - Non aspirare sostanze infiammabili, potenzialmente esplosive o corrosive e ceneri incandescenti. Queste sostanze possono compromettere la sicurezza e il funzionamento dell'apparecchio.
 - Non posare mai il cavo di alimentazione su spigoli vivi, non schiacciarlo e tenerlo lontano dalle spazzole elettriche rotanti
 - Utilizzare la presa di corrente (se montata) sulla macchina solo per gli scopi specificati nelle istruzioni.
 - In caso di perdite (schiuma o liquido) spegnere immediatamente l'apparecchio.



Se il cavo di alimentazione è danneggiato, deve essere sostituito dal produttore o da un centro di assistenza tecnica autorizzato o comunque da una persona con qualifica simile, in modo da prevenire qualsiasi rischio.

GARANZIA

- Questa macchina deve essere conservata solo al chiuso.
- Pulire frequentemente il sedile dove scorre il galleggiante di sicurezza e ispezionarlo periodicamente per verificarne l'integrità.
- Non utilizzare l'apparecchio quando il sistema di filtraggio è danneggiato.
- La classe di polvere "M" non si applica quando si aspira liquidi.

RICORDATE CHE

- In caso di contatto di sostanze potenzialmente pericolose con gli occhi o con la pelle, sciacquare con acqua e consultare un centro specializzato.
- In caso di sostanze potenzialmente pericolose sono state inalate o ingerite, chiamare un medico. Non indurre il vomito per evitare di contaminare i polmoni; si consiglia di sciacquare la bocca senza inghiottire acqua.
- Se, in caso di vomito spontaneo, si suppone che sia entrato nei polmoni di sostanze potenzialmente pericolose, trasporto in ospedale.

Il produttore declina ogni responsabilità per un uso improprio o non conforme alle istruzioni fornite, manomissione e manutenzione inadeguata dell'apparecchio.

SIMBOLI

DESCRIZIONE SIMBOLI ISTRUZIONI



Leggi
le istruzioni
prima di
utilizzare
l'apparecchio.



Attenzione
indica una
potenziale
situazione di
pericolo.



Nota
avvertenza per
un uso corretto



**Manuale
dell'operatore**
Istruzioni per
l'uso

CHIAVE DEI SIMBOLI



Presa per
utensili elettrici



Attacco
per utensili
pneumatici



Aspirapolvere a
umido e a secco



“Funzione
“filtro
autopulente



Professionale





Collegamento
del soffiatore



Industriale

SPECIFICHE TECNICHE

DV80

Tensione di alimentazione	120 V~ 230 V~
Frequenza	50/60 Hz
Potenza nominale	120V = 2400 W 230V = 2400 W
Flusso d'aria massimo ca.	110 L/sec
Tamburo di	
Capacità nominale del tamburo	80
Aspirazione MAX ca.	24 kPa
Classe di isolamento del motore	
Classe di isolamento dell'apparecchio	I ^a
Tipo di motore	Bypass ad alta efficienza
Dimensioni approssimative dell'apppliance	540 x 710 x 950 mm
Dimensione dell'imballaggio ca.	620 x 660 x 8850 mm
Peso dell'apparecchio imballato ca.	31 Kg
Peso dell'apparecchio *	25.2 Kg
Livello di pressione sonora costante e ponderata	< 69 dB(A)

* Weight in accordance with the procedure EPTA 01/2003

ACCESSORI

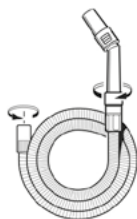

DV-ACC-506

Tubo flessibile
ø45 mm con
tubo flessibile
ergonomico
dispositivo
di presa e di
discesa



DV-ACC-115

Prolunghe in
plastica



DV-ACC-104

Strumento
crepaccio

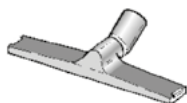

DV-ACC-114

Alloggiamento
per barra da
pavimento
per spazzola
combinata

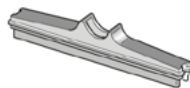

DV-ACC-102

Inserto a
pavimento per
liquidi

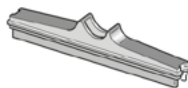

DV-ACC-101

Inserti per
pavimenti duri



DV-ACC-100

Inserto per
pavimenti in
barre per tappeti



DV-ACC-105

Accessorio
triangolare



DV-ACC-110

Spazzola
rotonda.



DV-ACC-124

Adattatore
multidiametro



DV-ACC-111

Prefiltro



DV-ACC-106

Filtro a schiuma
per l'aspirazione
di liquidi



DV-ACC-106

Filtro post
scarico
(fibra di cellulosa
+ HEPA)

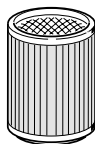

DV-ACC-504

"Cartuccia
filtrante "IFA"
Classe "M".
per DV 80



DV-ACC-501

Sacco filtrante
in pile a doppio
strato "IFA"
Classe "M".
per DV80

OPERAZIONE

ATTACCHIARE LA MANIGLIA DI TRASPORTO

Montare la maniglia di trasporto (A) sul tamburo (B) inserendola nei sedili laterali.

Bloccare con le viti di serraggio (D)

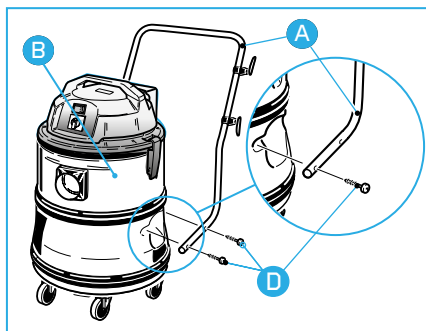

RILASCIO DELL'UNITÀ MOTORE

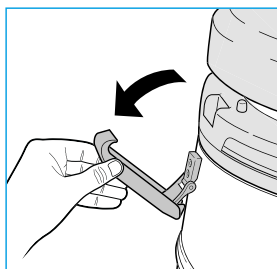
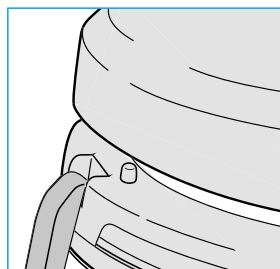

Per sbloccare l'unità motore.

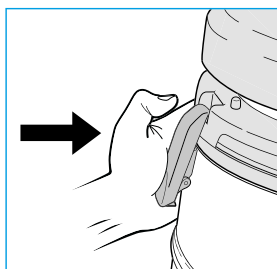
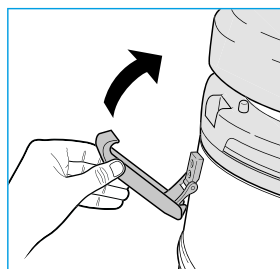

Per rimontare l'unità motore.

BOBINA DI IMMAGAZZINAMENTO DEL CAVO DI ALIMENTAZIONE

Posizione del gancio (E) come mostrato
in figura.

Per srotolare il cavo di alimentazione,
girare i ganci (E).

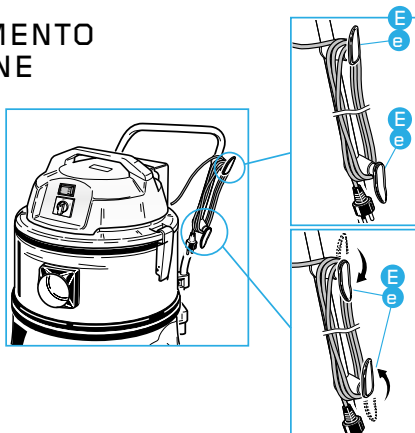

ACCENSIONE

Spia luminosa (A)

Interruttore di alimentazione (B):
posizione "O" - apparecchio spento
posizione "I" - Apparecchio acceso.

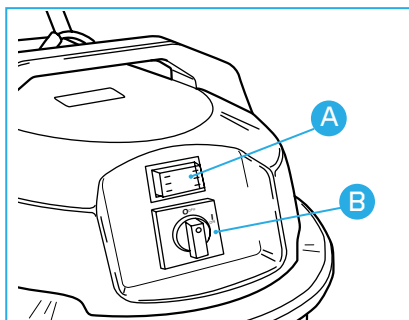

ATTACCHIARE IL TUBO FLESSIBILE

Collegare il connettore del tubo flessibile
(U) al connettore di ingresso dell'aria
(R).

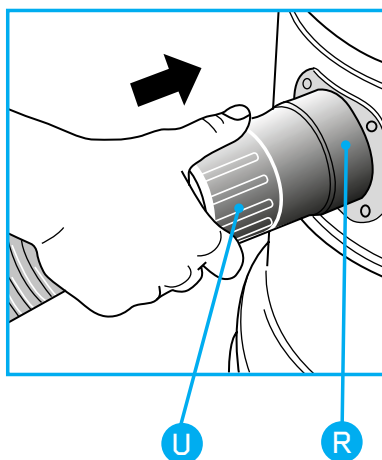

SISTEMI DI FILTRAGGIO

UTILIZZANDO IL FILTRO



Per aspirare la polvere di classe 'M' utilizzare sempre l'elemento filtrante. Evitare di utilizzare il filtro per materiali taglienti o umidi.

Posizionare il filtro (B) sulla carcassa del motore (C).

Montare il disco di plastica (A) sul filtro (B)



Si consiglia vivamente di utilizzare questo filtro per l'aspirazione di polvere e solidi; può essere utilizzato insieme al sacchetto di carta da filtro. Questo aiuta a prevenire l'intasamento dell'unità filtrante e ha il vantaggio di rendere lo smaltimento dei detriti aspirati rapido e sanitario. Evitare di utilizzarli per il taglio o per materiali umidi.

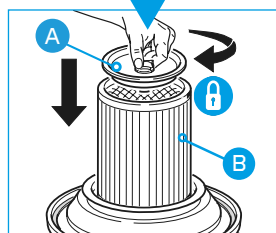
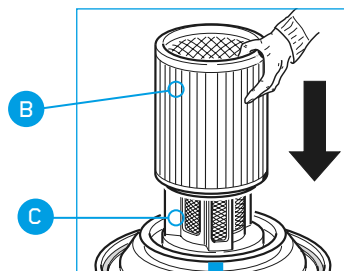
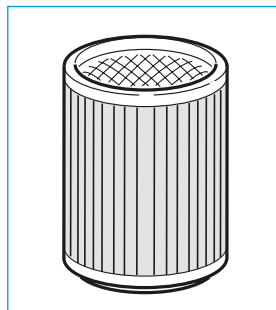

La cartuccia del filtro deve essere sempre utilizzata. Mantenere pulita la cartuccia filtro. Sostituirla se eccessivamente cotta o consumata.

UTILIZZANDO IL SACCHETTO PER LA POLVERE



Utilizzare il sacchetto della polvere solo quando la cartuccia del filtro è installata. Per raccogliere la polvere di classe 'M' il sacchetto della polvere deve essere installato nell'apparecchio.

Introdurre il sacchetto di fibra nel tamburo di scarico.

Inserire la flangia di plastica (X) nel connettore di ingresso dell'aria (Y). Fare attenzione a non danneggiare il sacco.

Cambiare il sacchetto quando si accende la spia (B).

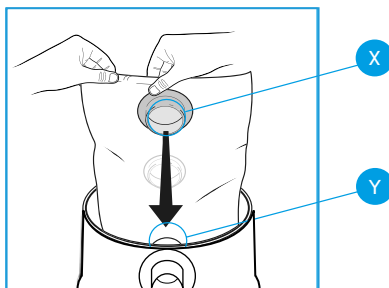
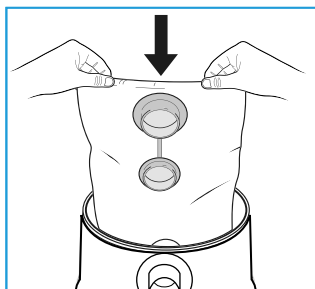

CAMBIARE IL SACCHETTO DELLA POLVERE



La borsa non deve essere riutilizzata e deve essere sempre cambiata.

Smaltire il sacchetto nel rispetto delle norme speciali per lo smaltimento dei rifiuti in vigore nel vostro paese

Rimuovere la flangia di plastica (1) dal connettore di ingresso dell'aria (2). Estrarre il sacchetto pieno. Chiudere la flangia di plastica con il tappo in dotazione.

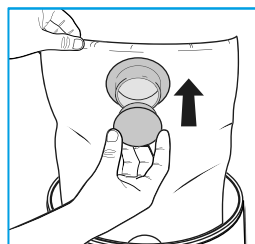
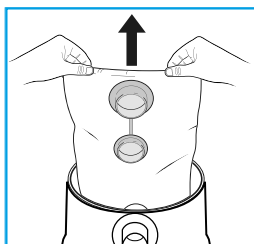
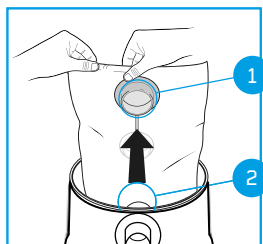



UTILIZZANDO IL PRE-FILTRO (OPZIONALE)

Utilizzare l'elemento filtrante per aumentare le "prestazioni" di filtrazione
Fissare il prefiltro (P) al bordo del cestello (G)

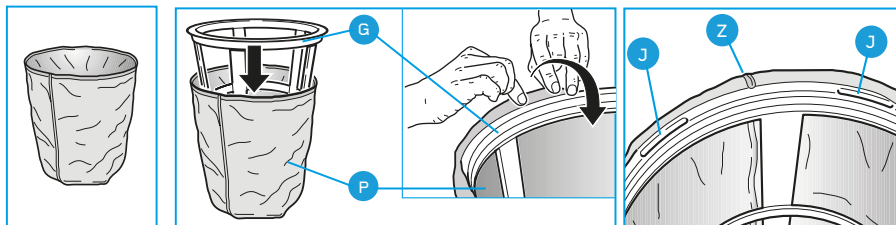

La cucitura (z) sul lato del prefiltro non deve sovrapporsi ai ganci (j) del cestello (g).

Montare l'anello (F) sul cestello (G) e inserire il gruppo prefiltro nel tamburo.

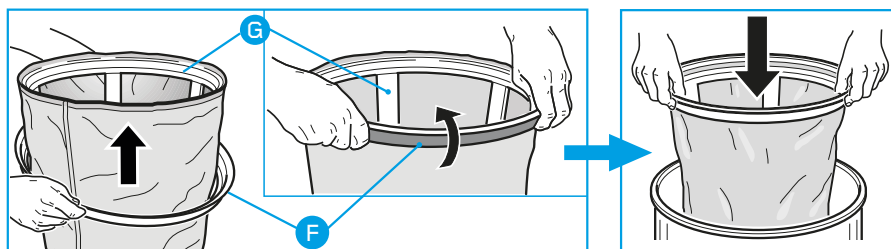

USCITA ARIA POST-FILTRO

Il post-filtro garantisce che l'aria ricircolata nell'ambiente sia priva di impurità.

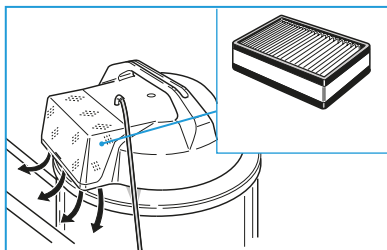

UTILIZZANDO IL FILTRO FOAM (VUOTO UMIDO)

Per aspirare i liquidi, utilizzare **SEMPRE** il filtro a schiuma.



L'elastico del filtro a schiuma deve adattarsi al bordo (V).

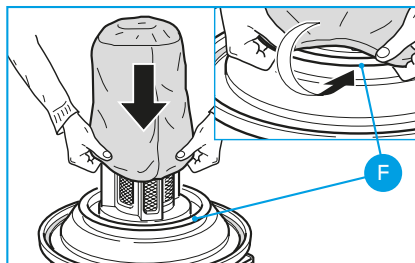

Rimuovere sempre la cartuccia del filtro e il sacchetto del filtro di carta, se presente. Utilizzare il filtro a schiuma. Il filtro a schiuma non è adatto per l'aspirazione di polvere di classe "M".

Quando i liquidi aspirati raggiungono il livello massimo all'interno del tamburo, l'aspirazione viene automaticamente interrotta dal galleggiante di sicurezza. L'utente viene avvisato da un aumento del numero di giri del motore e dalla mancanza di aspirazione. Spegnerne immediatamente l'apparecchio e svuotare il tamburo.

ASPIRAZIONE DI GRANDI QUANTITÀ DI LIQUIDO

Per garantire un flusso d'aria parziale, assicurarsi che l'utensile per fessure non sia mai completamente sommerso.

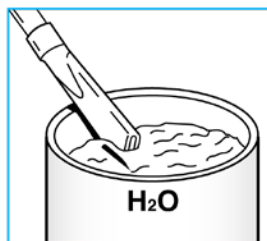

PULIZIA DELLA SCHIUMA FILTRO

Sciquare il filtro a schiuma con acqua. **NON** usare detersivi. Sostituire se usurato o strappato.

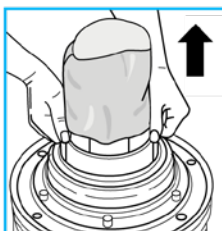

UTILIZZO DEL PROPRIETARIO



Il rubinetto di scarico (k) deve essere chiuso per evitare che il materiale sotto vuoto fuoriesca.

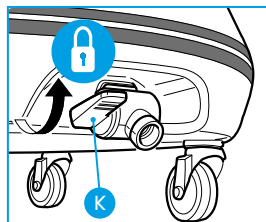

UTILIZZANDO LA FUNZIONE SOFFIANTE



La funzione di soffiatore può essere utilizzata solo in assenza di polveri di categoria 'L' e 'M'.

Rimuovere il contenitore (P) con il filtro di scarico HEPA

Collegare il connettore del tubo flessibile (U) al connettore di scarico (R) e ruotarlo in senso orario.

Accendere l'apparecchio. (Vedere pagina 102)

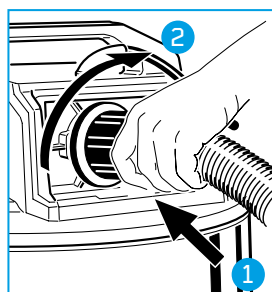
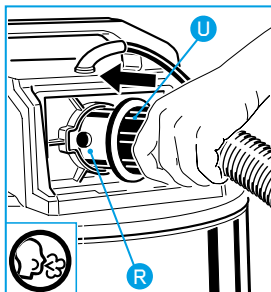
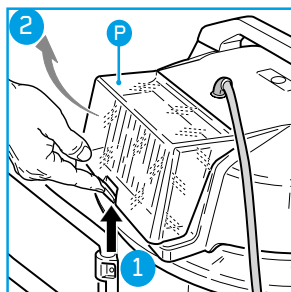

MANUTENZIONE



Scollegare sempre l'apparecchio dalla rete elettrica prima di effettuare qualsiasi operazione di pulizia o di manutenzione del sistema di filtraggio.

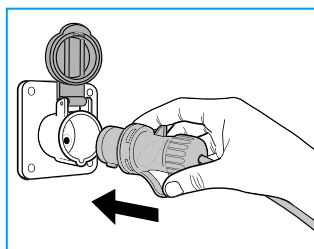

PULIZIA DELLA CARTUCCIA DEL FILTRO

Rimuovere il filtro dal supporto del motore.

Pulire frequentemente la cartuccia del filtro con una spazzola a setole morbide.

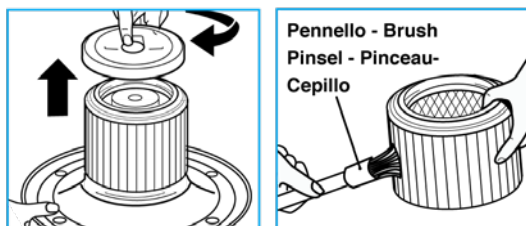

Non lavare MAI la cartuccia filtrante con acqua e/o altri liquidi.

PULIZIA DEL FILTRO PRE-FILTRO

Per pulire il cestino del prefiltro, scuotete il cestino nella spazzatura.
Se necessario, soffiarcì sopra.
Sostituirlo se indossato.

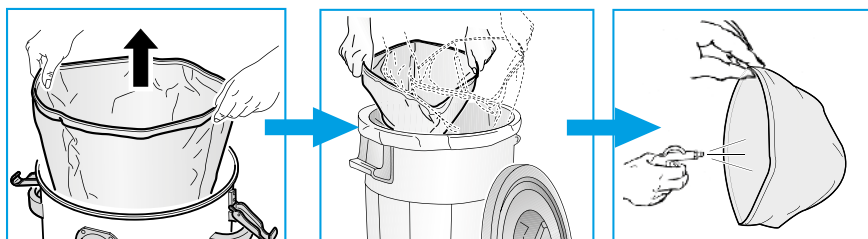

Non lavare MAI il prefiltro del contenitore con acqua e/o altri liquidi.

PULIZIA DEL FILTRO DI SCARICO

Sostituire periodicamente il post-filtro:

Rilasciare il contenitore (P), rimuovere il filtro di scarico;
Posizionare il nuovo filtro di scarico in modo che la guarnizione (O) sia rivolta verso l'esterno del contenitore (P);
chiudere il contenitore (P).

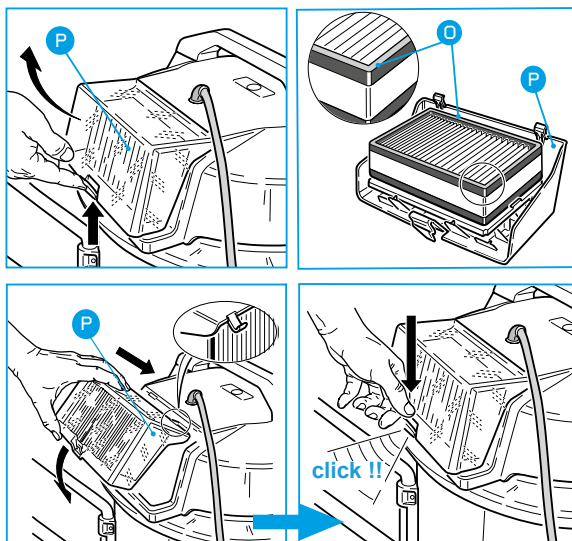

PULIZIA DEL TAMBURO

Dopo aver aspirato i liquidi, svuotare il tamburo e sciacquarlo insieme agli accessori per evitare la formazione di incrostazioni.

Per svuotare il contenitore del fusto dopo aver aspirato il liquido sostanze aprire il rubinetto di scarico (**K**) con motore spento.

Lavare frequentemente la sede in cui scorre il galleggiante di sicurezza per garantirne il corretto funzionamento.

Prima di aspirare di nuovo la polvere di classe 'M' assicurarsi che l'elemento filtrante e il sacco siano montati.

Lavare il cestello dopo ogni utilizzo.

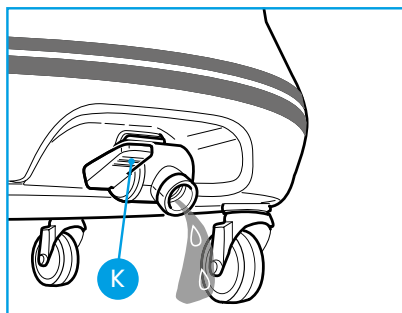



RISOLUZIONE DEI PROBLEMI

Problemi	Cause	Soluzioni
L'apparecchio non iniziare	Nessun potere Cavo di alimentazione, interruttori o motore difettosi.	Controllare che la presa di corrente sia funzionante Contattate il vostro centro di assistenza tecnica (vedi elenco allegato).
Ridotto Efficienza	Tamburo troppo pieno La cartuccia del filtro è sporca o cotta. Tubo o accessori intasati.	Tamburo vuoto Pulire accuratamente o sostituire il filtro, Controllare il tubo flessibile o gli accessori.
Il numero di giri del motore è notevolmente più alto.	Tamburo troppo pieno. La cartuccia del filtro è sporca o incastrata. Tubo o accessori intasati. Rubinetto di scarico (K) aperto	Controllare il tamburo. Pulire accuratamente o sostituire il filtro, Controllare il tubo flessibile o gli accessori. Chiudere il rubinetto di scarico (K)
La polvere esce dallo scarico post-filtro.	Il filtro principale è danneggiato o strappato.	Controllare il filtro e sostituirlo se necessario.



Non smaltire gli apparecchi elettrici con rifiuti domestici!

In conformità con la Direttiva Europea 2012/19/UE sui rifiuti di apparecchiature elettriche ed elettroniche (RAEE) e la sua attuazione in conformità con la legislazione nazionale, gli utensili elettrici che hanno raggiunto la fine del loro ciclo di vita devono essere raccolti separatamente e restituiti a un impianto di riciclaggio compatibile con l'ambiente.

DICHIARAZIONE "EC" DI CONFORMITÀ"

Il produttore dichiara che i prodotti descritti in queste istruzioni

DV80 MBN

Rispettare i requisiti essenziali delle direttive europee:

2014/35 / EU

2014/30 EU

2011/65 / EU

ed è conforme alle norme

EN 60335-1: 2012 + A11: 2014

EN 60335-2-69-2012

EN 62233: 2008

EN 55014-1: 2006 + A1: 2009 + A2: 2011

EN 55014-2: 2015

EN 61000-3-2: 2014

EN 61000-3-3: 2014

Questa dichiarazione è stata redatta nell'ottobre 2016.



ESPAÑOL

INSTRUCCIONES DE USO Y MANTENIMIENTO

ADVERTENCIAS	114
DESCRIPCIÓN SÍMBOLOS INSTRUCCIONES	119
CLAVE DE LOS SÍMBOLOS	119
ESPECIFICACIONES TÉCNICAS	120
ACCESORIOS	121
OPERACIÓN	123
SISTEMAS DE FILTROS	125
USO APROPIADO	129
MANTENIMIENTO	130
SOLUCIÓN DE PROBLEMAS	133
DECLARACIÓN DE CONFORMIDAD DE LA UE	134

ADVERTENCIAS



Los aparatos que se describen a continuación son idóneos para:

- Aspirar polvos y líquidos;
- Un uso profesional, por ej.: hoteles, colegios, hospitales, fábricas, tiendas, oficinas y agencias de alquiler.
- La separación de polvo seco (excepto si es explosivo, inflamable, cancerígeno y/o patógeno) con un valor límite de exposición, en función del volumen ocupado, igual o mayor a 0,1 mg/m³ (clase “M”).

Conserve cuidadosamente este manual de instrucciones.

- Un equipo eléctrico no es un juguete. Utilícelo y guárdelo fuera del alcance de los niños; supervise a los niños para asegurarse de que no jueguen con el aparato.
- Los componentes del embalaje (cartón, protecciones en PSE, etc.) deben mantenerse fuera del alcance de los niños.
- Este equipo no ha sido fabricado para ser utilizado por personas (incluyendo niños) con discapacidades físicas, sensoriales o mentales. Tampoco debe utilizarse sin haber leído antes este manual de instrucciones.
- Este aparato está diseñado para funcionar únicamente con corriente alterna. Antes de ponerlo en funcionamiento, asegúrese de que la tensión de red coincide con la que se indica en la placa de datos.



- Asegúrese de que la instalación eléctrica esté provista de interruptor diferencial (tipo salvavidas).
- Utilice un cable alargador sólo si está en perfectas condiciones y asegúrese de que la sección transversal es apropiada para la potencia del aparato más la potencia de la herramienta eléctrica.
- Nunca deje el aparato funcionando sin supervisión.
- Si el aire de descarga se libera de nuevo en el entorno de trabajo, debe tener un índice de intercambio de aire de clase “M” suficiente. Para respetar los valores límite requeridos, el flujo debe ser como máximo el 50% del flujo de aire fresco (volumen del ambiente VR por índice de intercambio de aire LW). También debe cumplir con la normativa vigente.
- Desenrolle completamente el cable de alimentación antes de poner en marcha el aparato.
- No dirija la manguera de aspiración a los oídos, los ojos, el pelo, las personas o los animales en general.
- Durante el transporte del aparato, el motor debe estar apagado. Asegúrese también de que el aparato no pueda dispersar el polvo en el ambiente y que esté en una posición estable
- Apague la máquina en caso de alta emisión de polvo, fuego o humo. El uso del aparato sólo está permitido después de que sea revisado y reparado por una persona autorizada.
- Desenchufe siempre el enchufe de la toma de corriente inmediatamente después de su uso y antes de realizar cualquier tipo de limpieza o mantenimiento en el aparato.

Peligro de Caída:

No se suba ni se siente sobre la carcasa del aparato.



ADVERTENCIAS

- Las reparaciones sólo pueden ser llevadas a cabo por especialistas que conserven las piezas de repuesto originales suministradas por el fabricante.
Reparar el aparato usted mismo puede ser extremadamente peligroso.
- De acuerdo con la normativa vigente, los aparatos que se vayan a desechar deben inutilizarse cortando el cable de alimentación antes de su eliminación.
- El aparato debe descontaminarse mediante métodos de limpieza con aspiradora y limpiarse o tratarse con sellador antes de sacarlo de una zona peligrosa. Todas las demás piezas del aparato se considerarán contaminadas cuando se saquen de la zona peligrosa y se tomen las medidas adecuadas para evitar la dispersión del polvo.
- Durante la limpieza y el mantenimiento se recomienda utilizar siempre dispositivos de protección personal (guantes y mascarilla) según lo dispuesto en las normas nacionales vigentes.
- Antes de proceder a las operaciones de mantenimiento, se recomienda encarecidamente descontaminar primero el aparato aspirando aire limpio durante unos minutos y limpiarlo por fuera.

Nunca utilice el aparato:

- con las manos mojadas o húmedas;
- si se ha caído y presenta signos de rotura evidentes o anomalías en el funcionamiento;
- si la clavija o el cable de alimentación eléctrica presenta defectos.

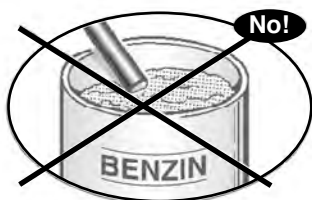

**Limpie el aparato solo con agua.
No utilice trielina, disolventes ni
detergentes abrasivos.**



-
- El mantenimiento y la limpieza deben realizarse en una habitación con una ventilación adecuada y de manera que no se ponga en peligro a los operarios o a otras personas.
 - Limpie el lugar donde se realiza el mantenimiento para evitar que se dispersen sustancias peligrosas en el medio ambiente.
 - Durante las operaciones de mantenimiento, reparación y eliminación, deben eliminarse todas las partes contaminadas del aparato que no puedan limpiarse por completo; colóquelas en bolsas impermeables de acuerdo con las normas nacionales vigentes para la eliminación de residuos especiales.
 - Para una correcta eliminación, es aconsejable indicar en la bolsa impermeable qué sustancias han sido aspiradas.
 - Se recomienda realizar una inspección técnica del aparato al menos una vez al año para comprobar la estanqueidad de los sellos y el buen funcionamiento de los mecanismos de control, a fin de poder detectar posibles fallos de funcionamiento. Comprobar diariamente la integridad del sistema de filtrado.
 - Este aparato ha sido diseñado para ser utilizado por personas debidamente capacitadas, específicamente en lo que respecta a la limpieza y el mantenimiento del aparato, los riesgos derivados de los materiales aspirados y su correcta eliminación, y la sustitución de las piezas de repuesto de acuerdo con las directivas vigentes en los distintos países.
 - No aspirar sustancias inflamables, potencialmente explosivas o corrosivas y cenizas incandescentes. Estas sustancias pueden comprometer la seguridad y el funcionamiento del aparato.
 - No coloque nunca el cable de alimentación sobre bordes afilados, no lo aplaste y manténgalo alejado de los cepillos eléctricos rotativos
 - Utilice la toma de corriente (cuando esté instalada) de la máquina sólo para los fines especificados en las instrucciones.
 - En caso de fugas (espuma o líquido), apague inmediatamente el aparato.



Si el cable de alimentación estuviera dañado deberá ser sustituido por el fabricante o por su servicio de asistencia técnica, o bien por una persona debidamente cualificada a fin de prevenir todo riesgo.

ATENCIÓN

- Este aparato debe guardarse exclusivamente en lugares cerrados.
- Limpie frecuentemente el alojamiento donde se desliza el flotador de seguridad y examínelo frecuentemente para comprobar su integridad.
- No utilice el aparato con el sistema filtrante dañado.
- aspire líquidos sólo si no están presentes polvos de clase “M”.

REMEMBER THAT

- caso de que sustancias potencialmente peligrosas entraran en contacto con los ojos y la piel, aclárelos con agua corriente y acuda a un centro especializado.
- En caso de inhalación o ingestión de sustancias peligrosas, llame a un médico. No provoque el vómito para que no se contaminen los pulmones; se aconseja aclarar la boca sin ingerir agua.
- Si, en caso de vómito espontáneo, se supone que se han aspirado sustancias potencialmente peligrosas, acuda inmediatamente a un hospital.

El fabricante declina toda responsabilidad en caso de uso inapropiado, incumplimiento de las instrucciones proporcionadas, alteración o mantenimiento inadecuado del aparato.



SÍMBOLOS

DESCRIPCIÓN SÍMBOLOS INSTRUCCIONES



Lea
las instrucciones
antes de usar el
aparato



Atención
indica una
situación de
potencial peligro



Nota
advertencia para
el uso correcto



**Manual del
operador**
Instrucciones
para el
funcionamiento

LEYENDA DE SÍMBOLOS



Toma para
herramientas
eléctricas



Conexión
para
herramientas
neumáticas



Aspirador
de polvo/
Aspirador de
líquidos



Función de
autolimpieza
del filtro



Profesional



Empalme de
soplado





Industrial



TECHNICAL SPECIFICATIONS

DV80

Tensión de alimentación eléctrica	120 V~ 230 V~
Frecuencia	50/60 Hz
Potencia	120V = 2400 W 230V = 2400 W
Caudal de aire MÁX. aprox.	110 L/sec
Tambor hecho de	
Capacidad nominal del depósito-bidón	80 L
Succión máxima aprox.	24 kPa
Clase de aislamiento del motor	
Clase de aislamiento del aparato	Iª
Tipo de motor	Bypass de alta eficiencia
Dimensiones aproximadas de la aplicación	540 x 710 x 950 mm
Dimensiones embalaje aprox.	620 x 660 x 8850 mm
Peso aparato embalado aprox.	31 Kg
Peso del aparato *	25.2 Kg
Nivel de presión sonora constante y ponderado	< 69 dB(A)

* Peso de acuerdo con el procedimiento EPTA 01/2003

ACCESSORIES

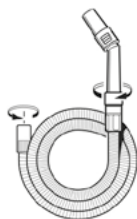

DV-ACC-506

Tubo flexible
ø45 mm con
empuñadura
ergonómica y
regulador de
flujo

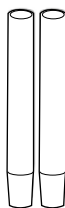

DV-ACC-115

Tubos rígidos de
plástico.



DV-ACC-104

Boquilla
rinconera.

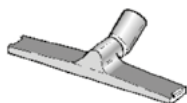

DV-ACC-114

Bastidor
para cepillo
combinado.

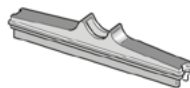

DV-ACC-102

Accesorio
recolector de
líquidos.

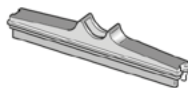

DV-ACC-101

Accesorio para
suelos duros.



DV-ACC-100

Accesorio para
las alfombras



DV-ACC-105

Accesorio triangular.



DV-ACC-110

Cepillo redondo.



DV-ACC-124

Adaptador multidímetro.



DV-ACC-111

Pre Filtro



DV-ACC-106

Filtro de espuma para sustancias líquidas.



DV-ACC-106

Filtro del poste de escape (fibra de celulosa + HEPA)

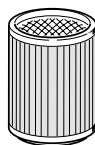

DV-ACC-504

Cartucho de filtro "IFA". Clase "M". para DV 80



DV-ACC-501

"IFA" bolsa de filtro de doble capa de vellón Clase "M" para DV80

USO DEL APARATO

ASEGURANDO EL MANGO DE TRANSPORTE

Colocar el asa de transporte (A) en el tambor (B) introduciéndola en los asientos laterales.

Bloquear con los tornillos de fijación (D).

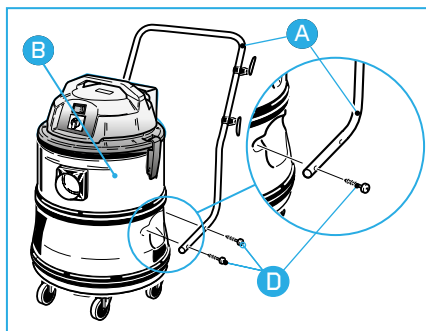

DESMONTAJE DEL MOTOR

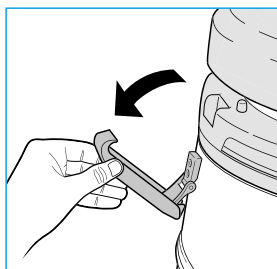
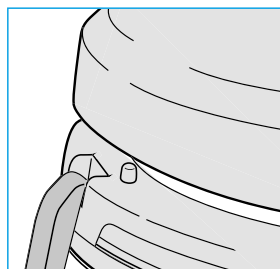

Para desmontar el motor.

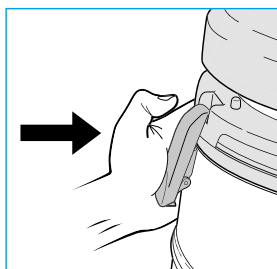
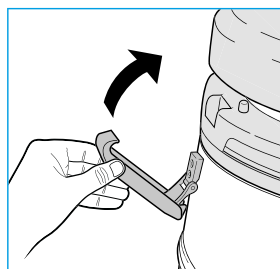

Para montar el motor.

CARRETE DE ALMACENAMIENTO DEL CABLE DE ALIMENTACIÓN

Posición del gancho (E) como se muestra en la figura.

Para desenrollar el cable de alimentación, gire los ganchos (E).

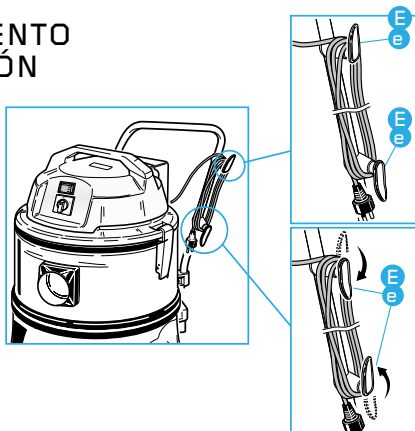

ENCENDIDO

Luz de advertencia (A)

Interruptor de encendido (B):
 posición "O" - Aparato apagado
 posición "I" - Aparato encendido.

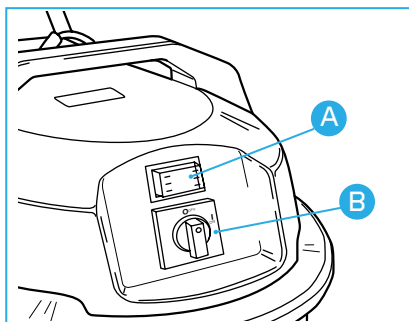

MONTAJE DEL TUBO FLEXIBLE

Introduzca el manguito del tubo flexible (U) en la conexión de entrada de aire (R).

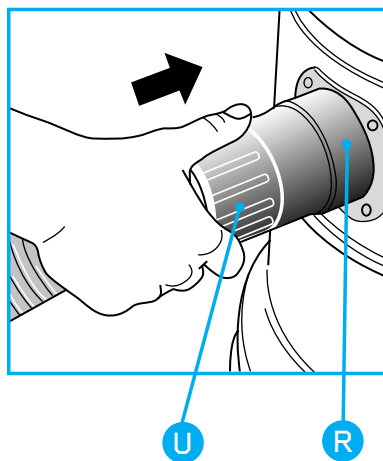

SISTEMAS FILTRANTES

USO DEL ELEMENTO FILTRANTE



Para aspirar polvos de clase “M” utilice siempre el elemento filtrante. No use las bolsas con materiales afilados o húmedos.

Coloque el elemento filtrante (B) sobre el soporte del motor (C).

Introduzca el disco adaptador de plástico (A) en el elemento filtrante (B).



El elemento filtrante está especialmente recomendado para recoger polvo o sustancias sólidas y puede utilizarse con la bolsa de filtro de papel que, además de evitar que el elemento filtrante se obstruya, ofrece la ventaja de manipular de manera rápida e higiénica el material aspirado.

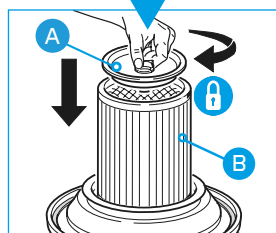
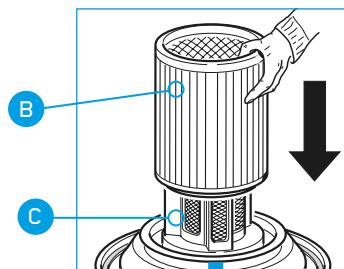
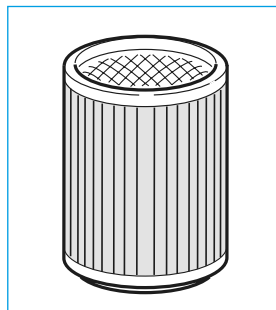

El cartucho de filtro debe usarse siempre. Mantenga el cartucho de filtro limpio. Reemplácelo si está demasiado endurecido o desgastado.

USO DE LA BOLSA RECOGE POLVO



Utilice la bolsa de polvo sólo cuando el cartucho de filtro esté instalado. Para recoger el polvo de clase 'M' la bolsa de polvo debe estar instalada en el aparato.

Introduce la bolsa de fibra en el tambor de residuos.

Encajar la brida de plástico (X) en el conector de entrada de aire (Y). Tenga cuidado de no dañar la bolsa.

Cambie la bolsa cuando se encienda la luz de advertencia (B).

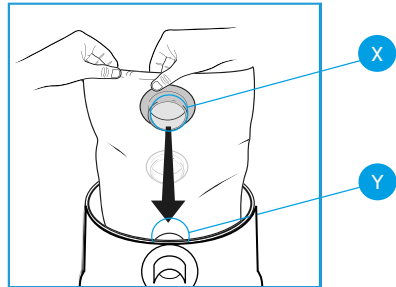
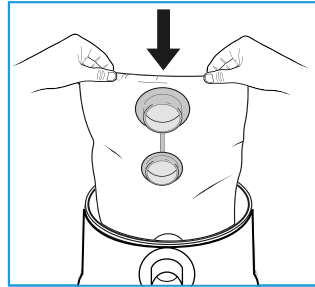

SUSTITUCIÓN DE LA BOLSA RECOGE POLVO



La bolsa no debe reutilizarse sino que debe sustituirse.

Elimine la bolsa de conformidad con las normativas para la eliminación de residuos especiales vigentes en cada país.

Extraiga la abrazadera de plástico (1) de la conexión de entrada de aire (2).
Extraiga la bolsa de filtro de papel. Cierre la abrazadera con el tapón correspondiente.

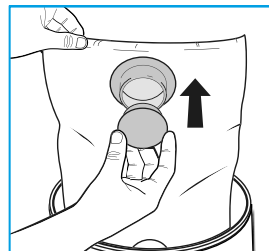
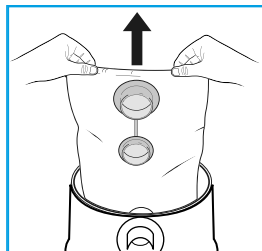
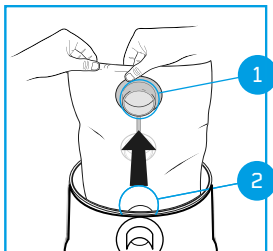



USANDO EL PRE-FILTRO (OPCIONAL)

Usar el elemento filtrante para aumentar el “rendimiento” de la filtración
Fijar el prefiltro (P) en el borde de la cesta (G)

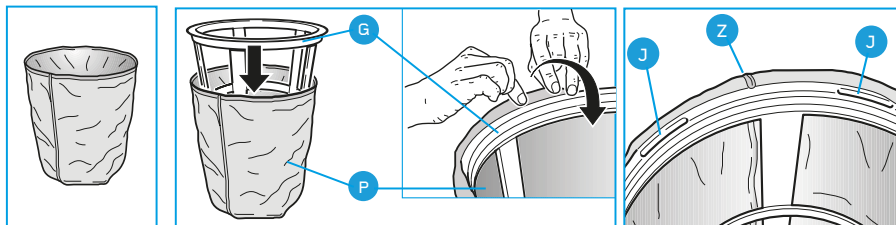

La costura (Z) del lado del prefiltro no debe superponerse a los ganchos (J) de la cesta (G).

Coloca el anillo (F) en la cesta (G) e inserta el conjunto de prefiltro en el tambor.

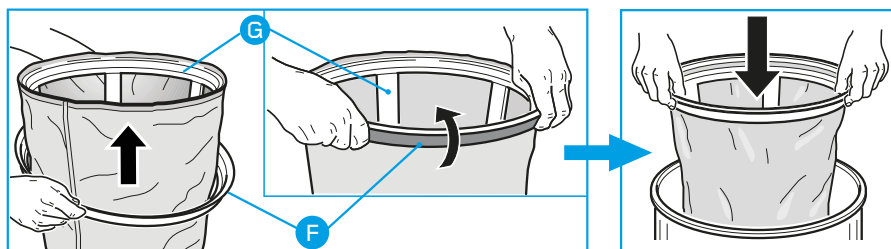

POSTFILTRO DE SALIDA DE AIRE

El postfiltro garantiza que el aire que se recicla en el ambiente está libre de impurezas.

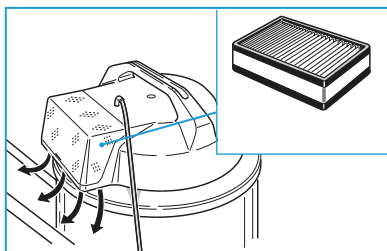

USANDO EL FILTRO DE ESPUMA (VACÍO HÚMEDO)

Para aspirar líquidos, use **SIEMPRE** el filtro de espuma.



El elástico del filtro de espuma debe encajar en el borde (V).

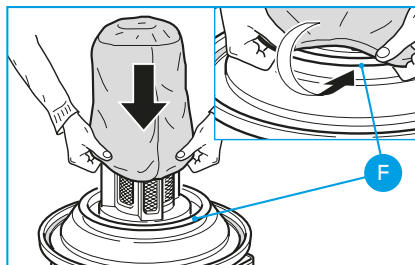

Retire siempre el cartucho de filtro y la bolsa de papel del filtro, si está instalada. Utilice el filtro de espuma. El filtro de espuma no es adecuado para aspirar polvo de clase "M".

Cuando los líquidos aspirados alcanzan el nivel máximo dentro del tambor, la succión se corta automáticamente por el flotador de seguridad. El usuario es alertado por un aumento en la velocidad del motor y la falta de succión. Apague el aparato inmediatamente y vacíe el tambor.

PARA ASPIRAR GRANDES CANTIDADES DE LÍQUIDOS

No sumerja completamente la boquilla rinconera para que haya un flujo parcial de aire.



LIMPIANDO LA ESPUMA FILTRO

Enjuague el filtro de espuma con agua. **NO** use detergente. Reemplácelo si está desgastado o roto.

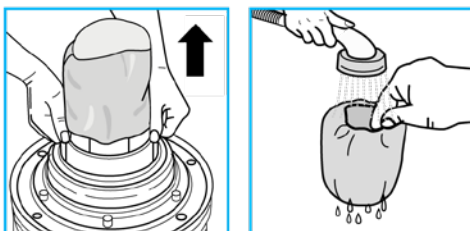

USO CORRECTO



El grifo de descarga (K) debe estar cerrado para evitar que el material aspirado se escape.

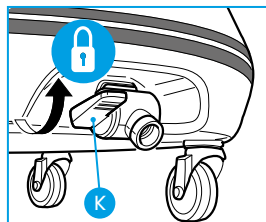

USING THE BLOWER FUNCTION



La función de soplador sólo puede utilizarse en ausencia de polvos de categoría 'L' y 'M'.

Retire el contenedor (P) con el filtro de escape HEPA

Conecte el conector de la manguera flexible (U) al conector de escape (r) y gírelo en el sentido de las agujas del reloj.

Encienda el aparato. (Vea la página 124)

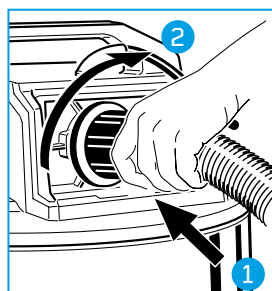
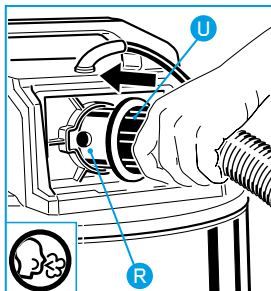
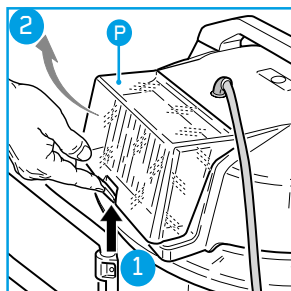

MANTENIMIENTO



Antes de llevar a cabo cualquier operación de mantenimiento (limpieza o sustitución) en el sistema filtrante, desenchufe el cable de alimentación eléctrica.

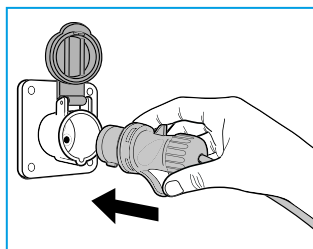

LIMPIAR EL CARTUCHO DE FILTRO

Retire el filtro del soporte del motor.

Limpie el cartucho del filtro frecuentemente con un cepillo de cerdas suaves.

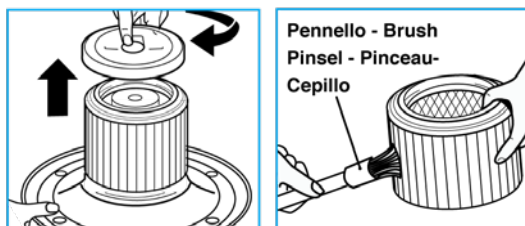

NUNCA lavar el cartucho de filtro con agua y/u otros líquidos.



LIMPIAR EL FILTRO DE PRE-FILTRO

Para limpiar la cesta del prefiltro, sacúdela a la basura.
Sople en ella si es necesario.
Reemplázela si está desgastada.

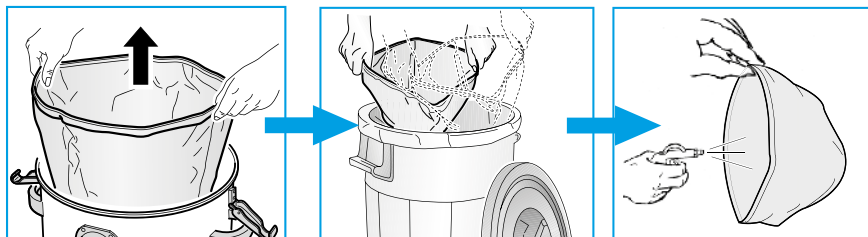

NUNCA lavar el prefiltro del bote con agua y/o otros líquidos.

LIMPIANDO EL FILTRO DE ESCAPE

Reemplace el postfiltro periódicamente:

Libere el contenedor (P), retire el filtro de escape; Coloque el nuevo filtro de escape de manera que el sello (O) esté orientado hacia el exterior del contenedor (P); cierre el contenedor (P).

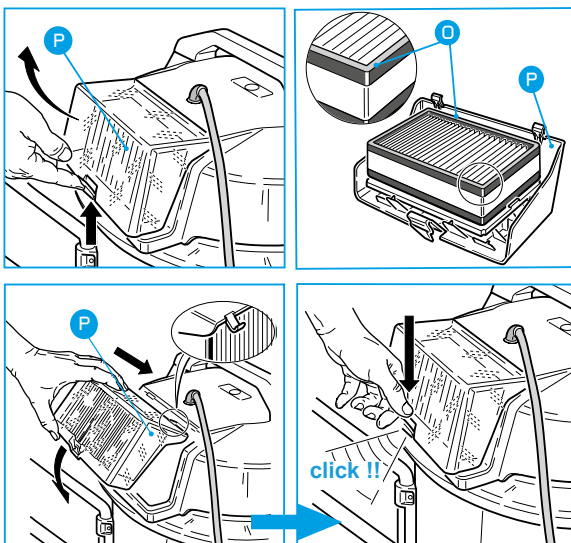

LIMPIANDO EL TAMBOR

Después de aspirar los líquidos, vacíe el tambor y enjuáguelo junto con los accesorios para evitar la formación de incrustaciones.

Para vaciar el contenedor del tambor después de aspirar el líquido sustancias abren el grifo de drenaje (K) con el motor apagado.

Lavar frecuentemente el asiento donde se desliza el flotador de seguridad para asegurar su correcto funcionamiento.

Antes de aspirar el polvo de clase “M” de nuevo, asegúrese de que el elemento filtrante y la bolsa estén colocados.

Lave el tambor después de cada uso.

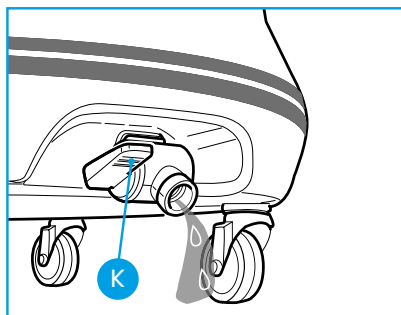



SOLUCIÓN DE PROBLEMAS

Efectos	Causas	Soluciones
El aparato no empezar	No hay energía Cable de alimentación, interruptores o motor defectuosos.	Comprueba que la toma de corriente funciona Póngase en contacto con su centro de servicio técnico (véase la lista adjunta).
Reducido Eficiencia	Tambor demasiado lleno El cartucho de filtro está sucio o apelmazado. Tubo o accesorios obstruidos.	Tambor vacío Limpia a fondo o cambia el filtro, Revise la manguera o los accesorios.
La velocidad de las RPM del motor es notablemente mayor.	El tambor está demasiado lleno. El cartucho de filtro está sucio o atascado. Tubo o accesorios obstruidos. Llave de drenaje (K) abierta	Revise el tambor. Limpie a fondo o cambie el filtro, Revise la manguera o los accesorios. Cierre el grifo de desagüe (K)
El polvo sale del escape post-filtro.	El filtro principal está dañado o roto.	Revise el filtro y cámbielo si es necesario.



¡No deseche los aparatos eléctricos junto con los residuos do-mésticos!

De conformidad con las Directivas Europeas 2012/19/EU sobre residuos de aparatos eléctricos y electrónicos y su aplicación de acuerdo con la legislación nacional, las herramientas eléctricas cuya vida útil haya llegado a su fin, se deberán recoger por separado y trasladar a una planta de reciclaje que cumpla con las exigencias ecológicas.

DECLARACIÓN DE CONFORMIDAD "CE"

El fabricante declara que los productos descrito en este manual de instrucciones

DV80 MBN

responden a los requisitos esenciales de las Directivas Europeas

2014/35 / EU

2014/30 EU

2011/65 / EU

y cumplen con las normas

EN 60335-1: 2012 + A11: 2014

EN 60335-2-69:2012

EN 62233: 2008

EN 55014-1: 2006 + A1: 2009 + A2: 2011

EN 55014-2: 2015

EN 61000-3-2: 2014

EN 61000-3-3: 2014

Esta declaración se redactó en el mes de octubre del año 2016.



MAXVAC

 Mülibodenstrasse 3
CH-8172 Niederglat
Zürich, Schweiz

 +41(0) 43 411 4195

 max-vac.com