

100% of Actual Size
Screen Print (one colour)

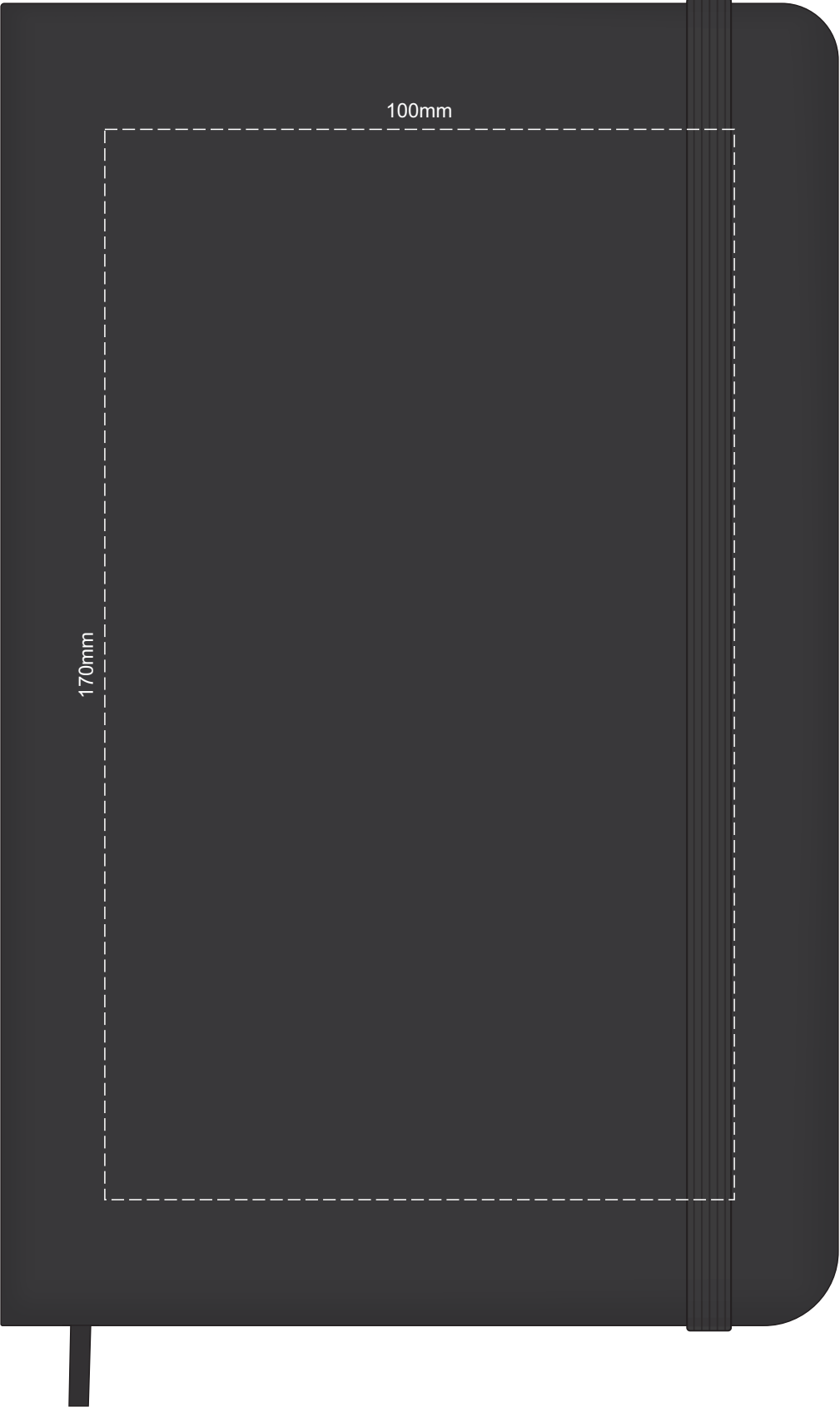

100% of Actual Size
Debossing Front Cover
Debossing XL Front Cover

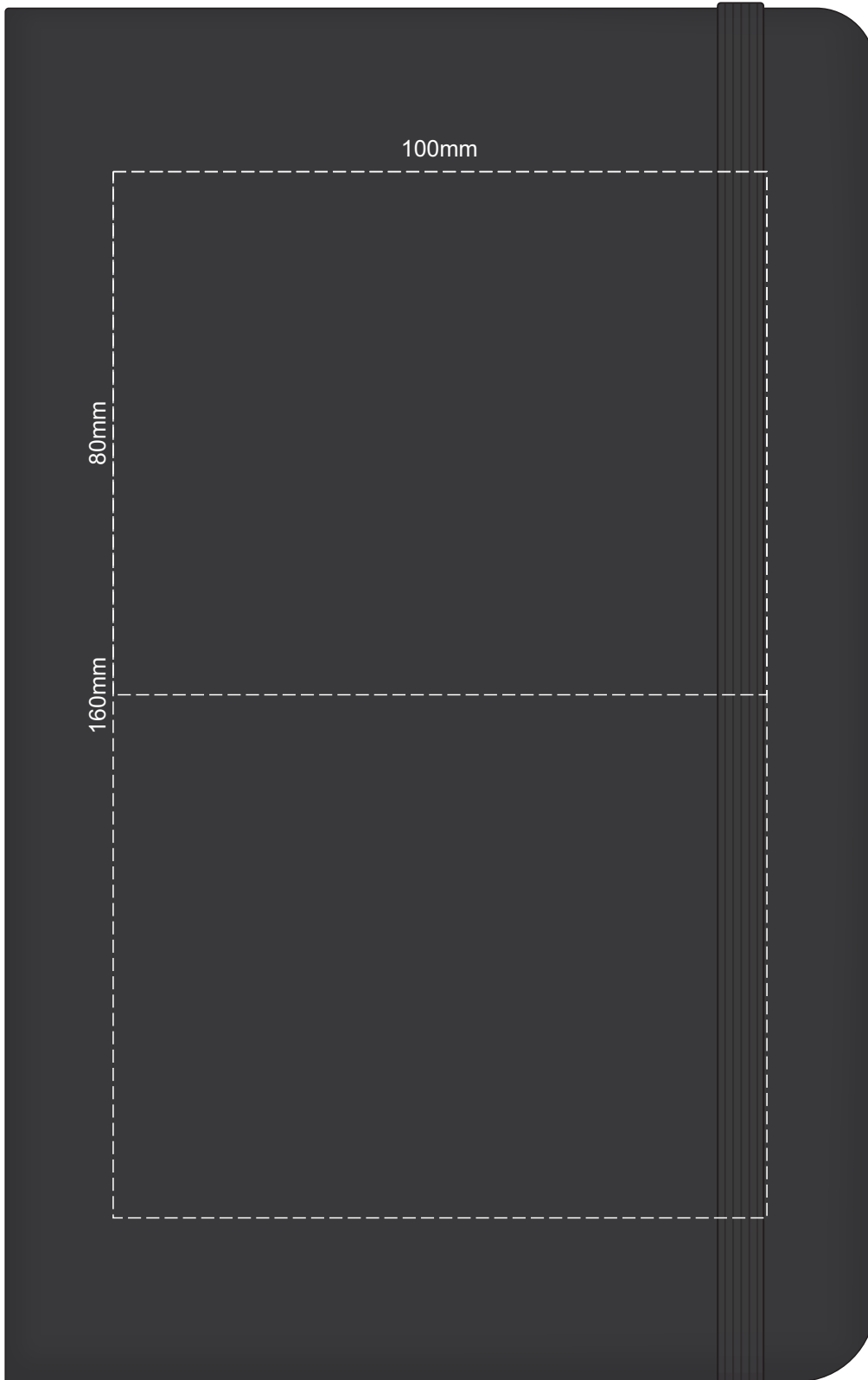

Print area 100 x 80mm is moveable within the XL deboss area and can rotate to suit.

100% of Actual Size
Debossing Back Cover

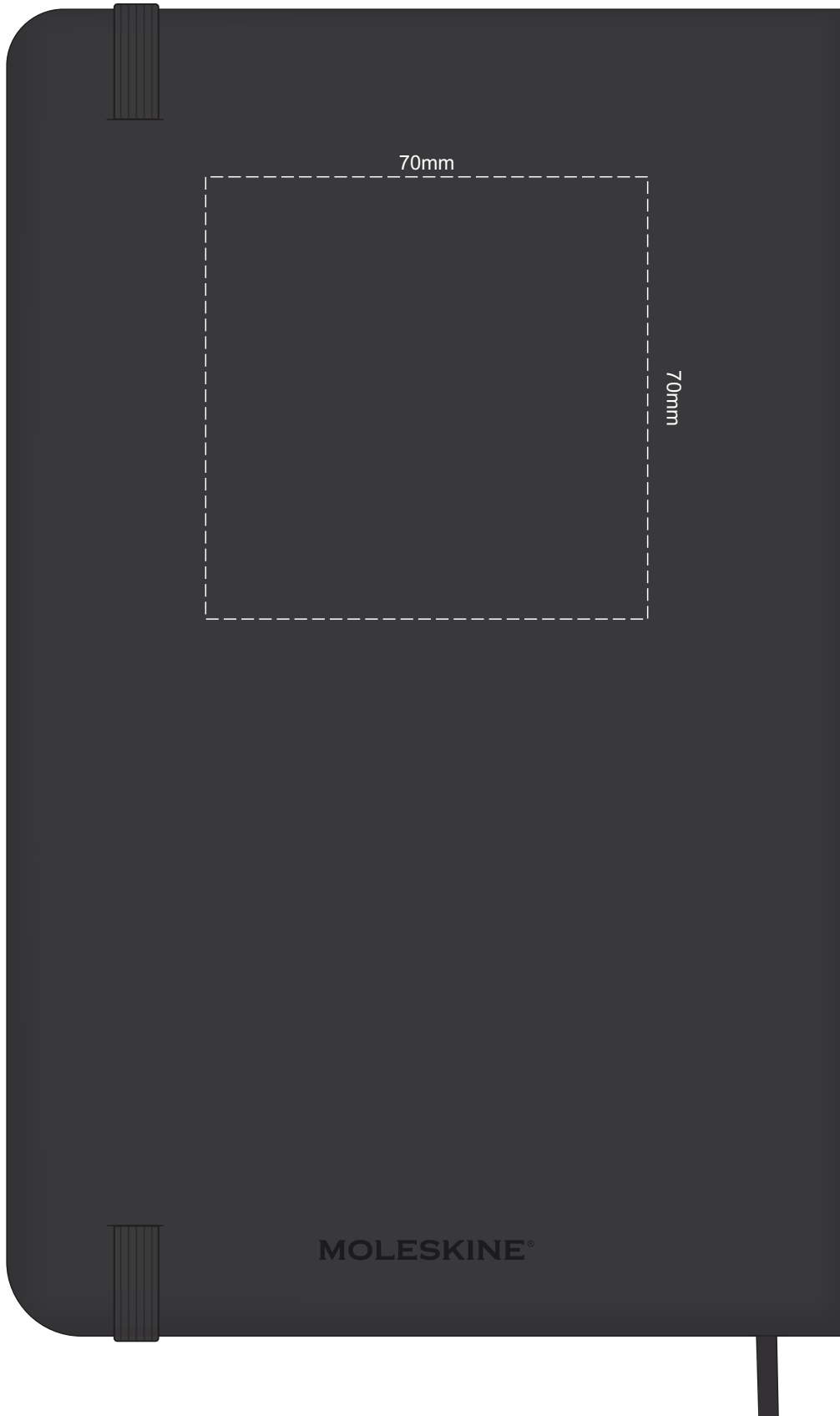

70% of Actual Size
Pad Print Front End-Paper

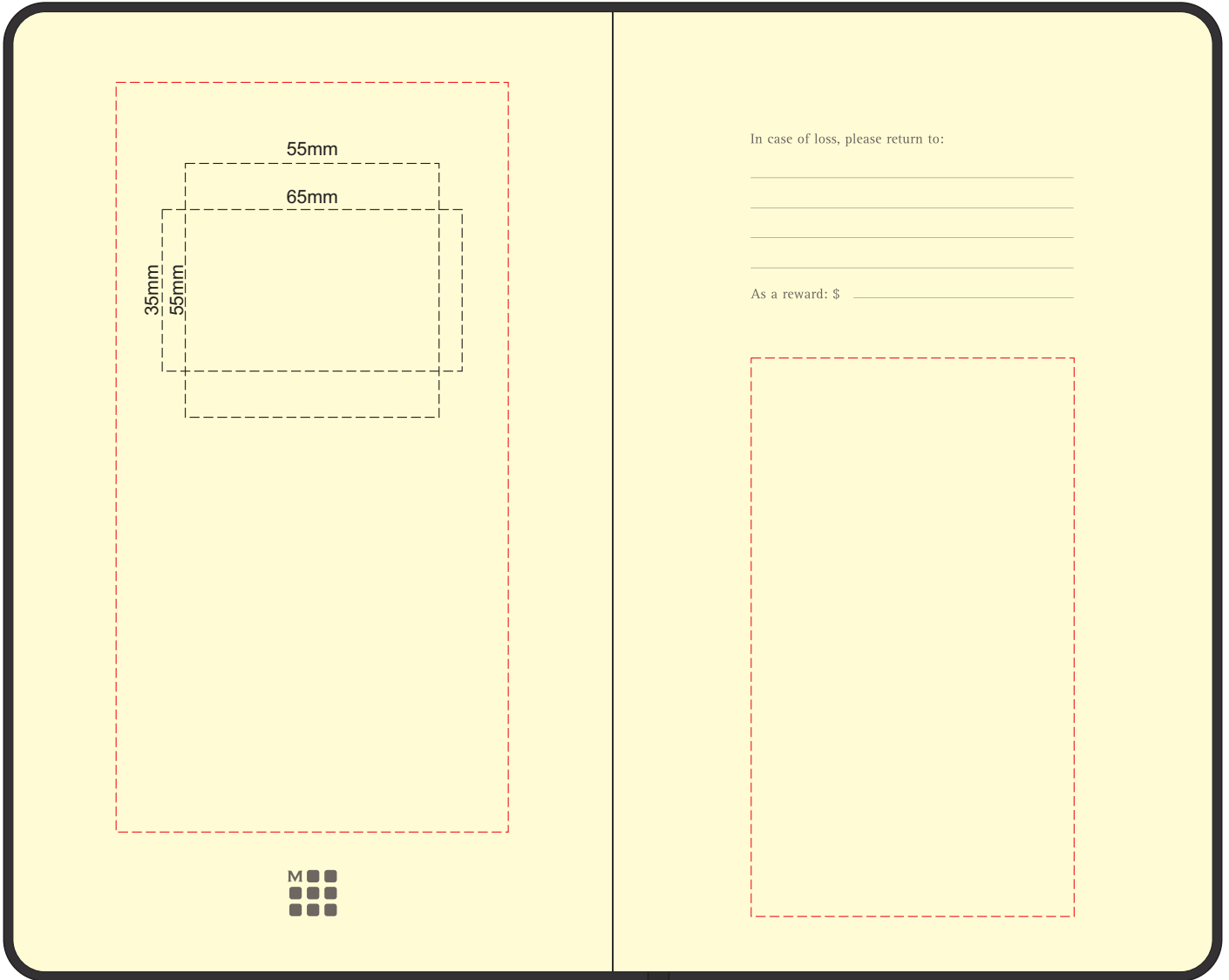

Branding area can be moved anywhere within the red lines.

70% of Actual Size
Pad Print Back End-Paper

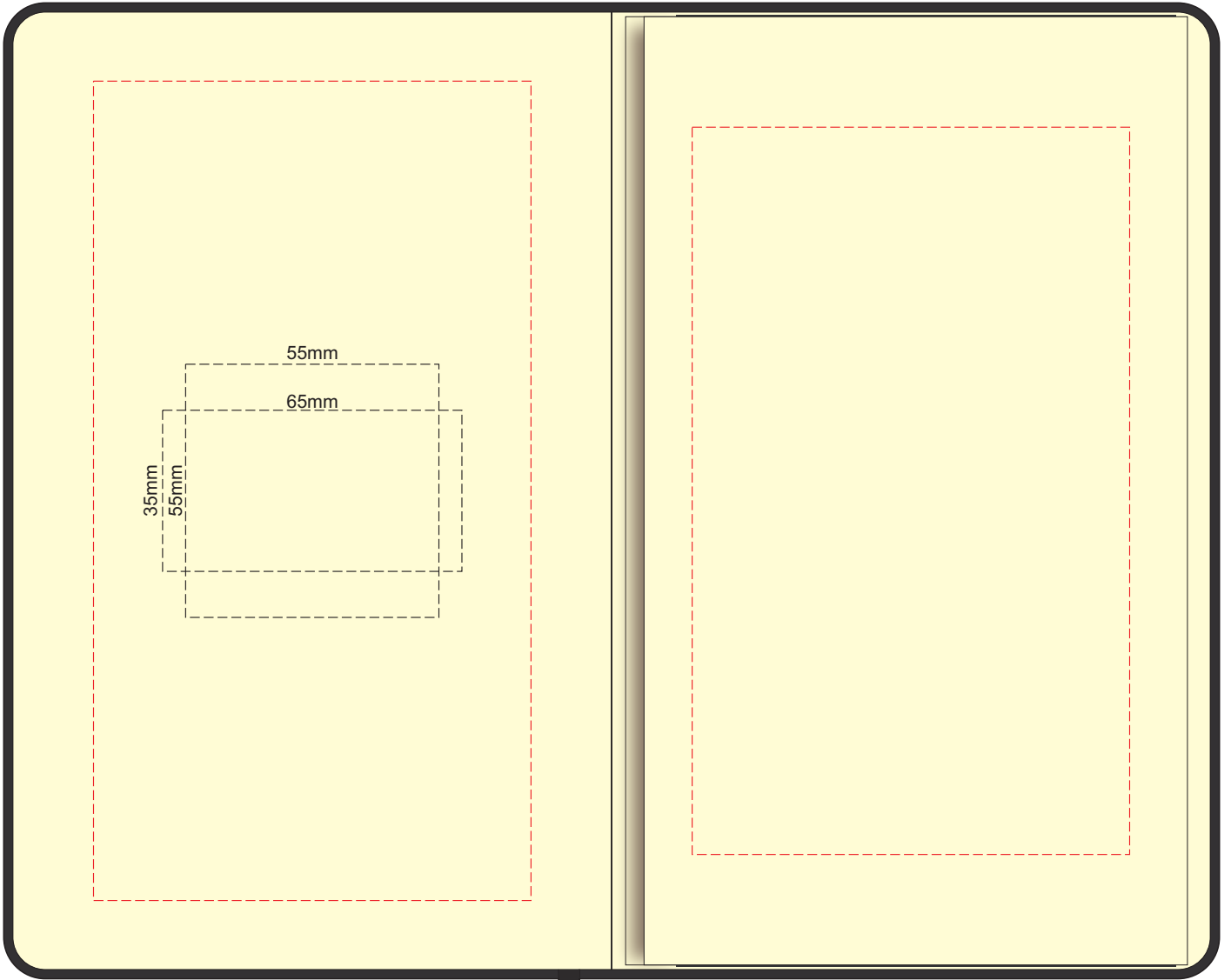

Branding area can be moved anywhere within the red lines.

70% of Actual Size
Digital Print - Belly Band Template

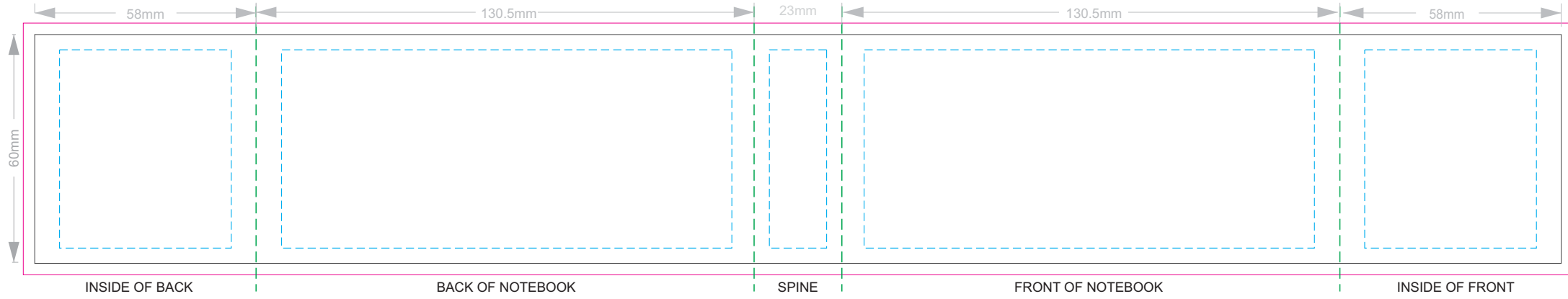

25% of Actual Size

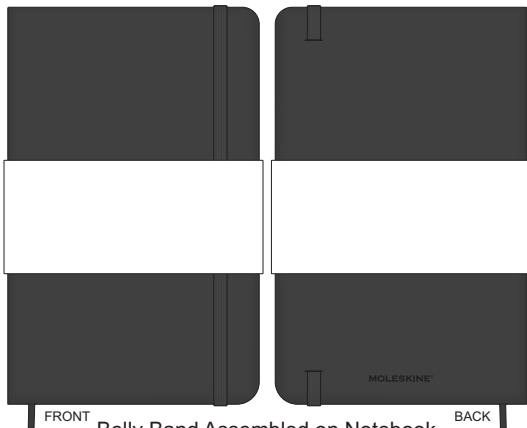

Belly Band Assembled on Notebook

- Green Line = Fold Lines when assembled on notebook
- Blue Line = The SIGNIFICANT PRINT AREA
(Keep all critical images & text within this box)
- Black Line = Maximum print area
- Pink Line = Bleed off to here